



ORIGINAL INSTRUCTIONS

Instruction Manual
Compact Pressure Switch
ZSE3 / ISE3(L)



The intended use of the compact pressure switch is to measure, monitor and display pressure and provide an output signal.

1 Safety Instructions

These safety instructions are intended to prevent hazardous situations and/or equipment damage. These instructions indicate the level of potential hazard with the labels of "Caution," "Warning" or "Danger." They are all important notes for safety and must be followed in addition to International Standards (ISO/IEC)^{*)}, and other safety regulations.

- *) ISO 4414: Pneumatic fluid power - General rules relating to systems.
- ISO 4413: Hydraulic fluid power - General rules relating to systems.
- IEC 60204-1: Safety of machinery - Electrical equipment of machines. (Part 1: General requirements)
- ISO 10218-1: Robots and robotic devices - Safety requirements for industrial robots - Part 1: Robots.
- Refer to product catalogue, Operation Manual and Handling Precautions for SMC Products for additional information.
- Keep this manual in a safe place for future reference.

	Caution	Caution indicates a hazard with a low level of risk which, if not avoided, could result in minor or moderate injury.
	Warning	Warning indicates a hazard with a medium level of risk which, if not avoided, could result in death or serious injury.
	Danger	Danger indicates a hazard with a high level of risk which, if not avoided, will result in death or serious injury.

Warning

- Always ensure compliance with relevant safety laws and standards.
- All work must be carried out in a safe manner by a qualified person in compliance with applicable national regulations.
- This product is class A equipment intended for use in an industrial environment. There may be potential difficulties in ensuring electromagnetic compatibility in other environments due to conducted or radiated disturbances.
- Refer to the operation manual or catalogue on the SMC website (URL: <https://www.smcworld.com>) for more safety instructions.

2 Specifications

2.1 General specifications

Model No.	ZSE3 Vacuum	ISE3L Low pressure	ISE3 High pressure
Rated pressure range	0 to -101 kPa	0 to 98 kPa	0 to 0.98 MPa
Min. display unit	1 kPa		0.01 MPa
Applicable fluid	Air, inert and incombustible gases		
Max. operating pressure	200 kPa *1		1 MPa
Power supply voltage	12 to 24 VDC ±10%, ripple (P-P) 10% or less (Protected against inverse connection)		
Current consumption	25 mA or less		
Switch output	Output type	NPN open collector output	
	Max. load current	80 mA	
	Max. applied voltage	30 VDC	
	Response time	5 msec	
Repeatability	±1% F.S.		
Hysteresis	Hysteresis mode *4,2	Variable (0 digits or more)	
	Window comparator mode	Fixed (3 digits)	
Analogue output *2,3	Voltage output: 1 to 5 V ±5% Output impedance: Approx. 1 kΩ		
Display method	3 1/2 digits LCD (character height 5 mm)		
Indicator light *3,4	Light when ON OUT1: Green OUT2: Red		
Self-diagnosis function	Detection of overcurrent, overpressure, data error and pressure during zero clear		
Error indication	Indicator: Red flashing, Error code is displayed on LCD		
Environmental	Enclosure	IP40	
	Ambient temperature range	0 to 60 °C (No condensation or freezing)	
	Withstand voltage	1000 VAC, 50/60 Hz, 1 minute, Between the external terminal and the case	
	Insulation resistance	2 MΩ (at 500 VDC) Between the external terminal and the case	
Temperature characteristic	±3% F.S.		
Port size	R1/8: M5x0.8 NPTF1/8: M5x0.8 With suction filter: M5x0.8 (M6x1 made to order).	R1/8: M5x0.8 NPTF1/8: M5x0.8	
Lead wire	Connector type	Heat-resistant vinyl electric wire, 4-wire, Cross section: 0.31 mm ² , Insulator O.D.: 1.55 mm	
	Grommet type	Oil-resistant vinyl cabtire code -21, -23: 4 cores, ø3.5, Cross section: 0.14 mm ² , Insulator O.D.: 1.0 mm -22, -24: 5 cores, ø3.5, Cross section: 0.15 mm ² , Insulator O.D.: 1.0 mm	
Weight	40 g (including 0.6 m lead wire)		

*1: When vacuum is used, there is no influence on the switch even if 0.5 MPa of pressure is supplied instantaneously.
*2: Window comparator mode: Since the hysteresis is 3 digits, P1 should be separated from P2 by 7 digits or more.
1 digit is the minimum pressure display unit.
*3: Only for the pressure switch with analogue output selected.
*4: In case of ZSE3-#-23 or 24, failure predictive output: Red.

2 Specifications (continued)

2.2 Analogue Output

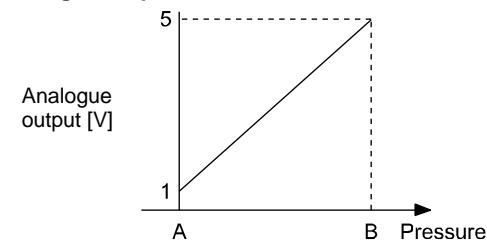

Model No.	Rated pressure range	A	B
ZSE3	0 to -101 kPa	0	-101 kPa
ISE3L	0 to 98 kPa	0	98 kPa
ISE3	0 to 0.98 MPa	0	0.98 MPa

3 Summary of Product parts

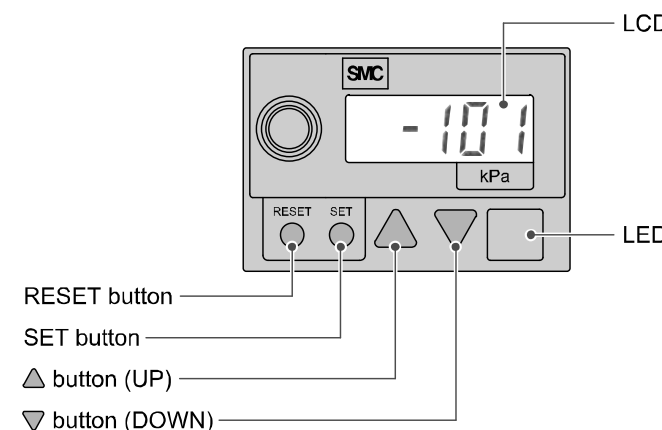

Part	Description
RESET button	Resets an error and for zero clear of the display.
SET button	Selects the setting mode and enters the set value.
LCD display	Displays pressure value, setting mode, and error codes.
LED	The green LED is ON when output OUT1 is ON. The red LED is ON when output OUT2 is ON and failure predictive output. When both OUT1 and OUT2 are ON, both the green and red LED's are ON. When an error occurs the red LED flashes.
UP button	Selects the peak display mode and increases the ON/OFF set value.
DOWN button	Selects the bottom display mode and decreases the ON/OFF set value.

4 Installation

4.1 Installation

Warning

Do not install the product unless the safety instructions have been read and understood.

4.2 Environment

Warning

- Do not use in an environment where corrosive gases, chemicals, salt water or steam are present.
- Do not use in an explosive atmosphere.
- Do not expose to direct sunlight. Use a suitable protective cover.
- Do not install in a location subject to vibration or impact. Check the product specifications.
- Do not mount in a location exposed to radiant heat.

4 Installation (continued)

4.3 Piping

Caution

- Before connecting piping make sure to clean up chips, cutting oil, dust etc.
- When installing piping or fittings, ensure sealant material does not enter inside the port. When using seal tape, leave 1 thread exposed on the end of the pipe/fitting.
- Connect the digital pressure switch to the piping with a hexagon socket head plug and a fitting.
- The tightening torque for the piping port must be 8.8 N•m maximum.

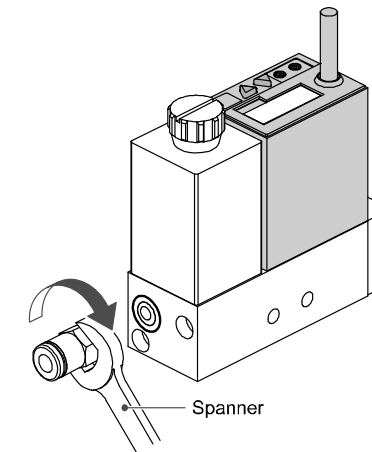

4.4 Lubrication

Caution

- SMC products have been lubricated for life at manufacture, and do not require lubrication in service.
- If a lubricant is used in the system, use turbine oil Class 1 (no additive), ISO VG32. Once lubricant is used in the system, lubrication must be continued because the original lubricant applied during manufacturing will be washed away.

5 Wiring

5.1 Wiring connections

- Connections should be made with the power supply turned OFF.
- Use a separate route for the product wiring and any power or high voltage wiring. Otherwise, malfunction may result due to noise.
- If a commercially available switching power supply is used, be sure to ground the frame ground (FG) terminal. If the switching power supply is connected for use, switching noise will be superimposed and it will not be able to meet the product specifications. In that case, insert a noise filter such as a line noise filter/ferrite between the switching power supplies or change the switching power supply to a series power supply.
- Incorrect wiring will lead to digital pressure switch damage, failure or malfunction. Be sure to confirm the wire colour and terminal number before wiring.

5.2 Connector attaching / detaching

- When assembling the connector, push it straight onto the pins until the lever locks into the housing.
- To remove the connector, push the lever down to unlock the hook from the groove, and withdraw the connector straight out.

Mating connector wiring details:

Wire size: 0.2 to 0.33 mm² max.

Wire sheath diameter 1.7 mm max.

Strip 3.2 to 3.7 mm of lead wire and fit crimp SMC Part No. DXT170-71-1.

Crimping tool: SMC Part No. DXT170-75-1.

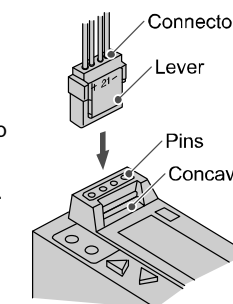

5 Wiring (continued)

5.3 Wiring diagram

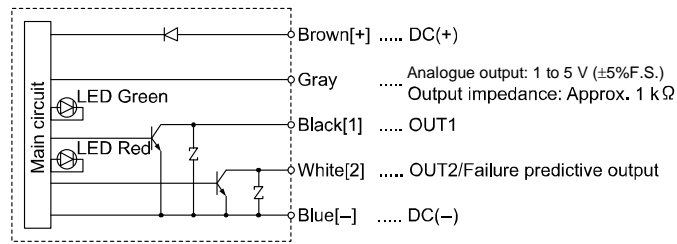

5.4 Internal circuit and wiring

ZSE3 / ISE3(L)-#21

Switch output, NPN open collector output, 2 outputs, Max. 30 V, 80 mA

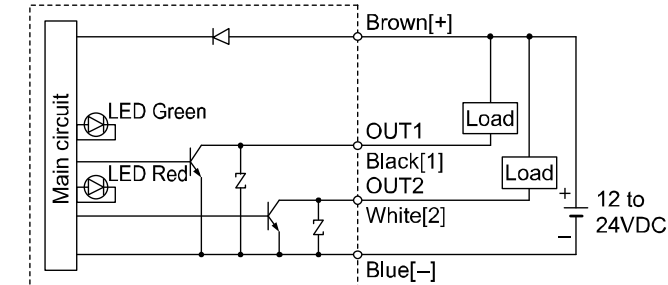

ZSE3 / ISE3(L)-#22

Switch output, NPN open collector output, 2 outputs, Max. 30 V, 80 mA
Analogue output: 1 to 5 V, Output impedance: Approx. 1 kΩ

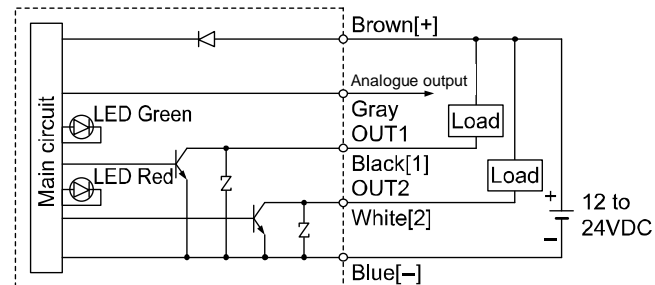

ZSE3 / ISE3(L)-#23

Switch output, NPN open collector output, 1 output, Max. 30 V, 80 mA
Failure predictive output, NPN open collector output, 1 output.

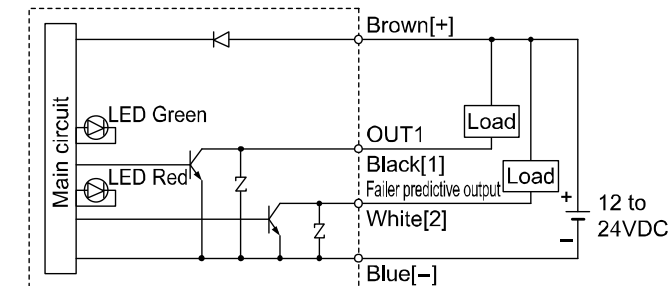

ZSE3 / ISE3(L)-#24

Switch output, NPN open collector output, 1 output, Max. 30 V, 80 mA
Failure predictive output, NPN open collector output, 1 output.
Analogue output: 1 to 5 V, Output impedance: Approx. 1 kΩ

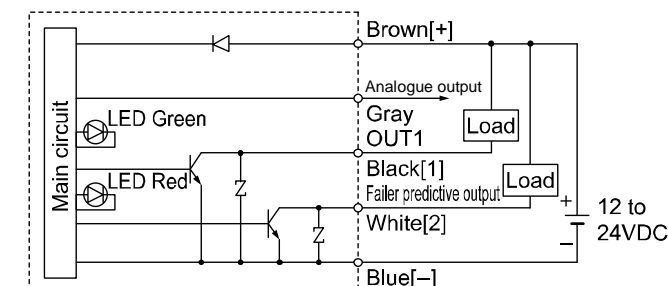

6 Pressure Setting

6.1 2 output type

1. Set value input mode

Press the "SET" button to display "P1-20" *1.
The output OUT1(1) set value input mode is selected.
*1: If the set value of P1 is -20.



2. OUT1(1) set value input

Pressing the \blacktriangle button increases the set value.
Pressing the \blacktriangledown button decreases the set value.
Press the "SET" button to save the set value and select the output OUT1(2) set value input mode.
The set value of P2 is displayed.

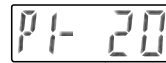

3. OUT1(2) set value input

Pressing the \blacktriangle button increases the set value.
Pressing the \blacktriangledown button decreases the set value.
Press the "SET" button to save the set value and select the output OUT1(1) set value input mode.
The set value of P3 is displayed.



4. OUT2(1) set value input

Pressing the \blacktriangle button increases the set value.
Pressing the \blacktriangledown button decreases the set value.
Press the "SET" button to save the set value and select the output OUT2(2) set value input mode.
The set value of P4 is displayed.

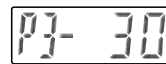

5. OUT2(2) set value input

Pressing the \blacktriangle button increases the set value.
Pressing the \blacktriangledown button decreases the set value.
Press the "SET" button to save the set value and exit this mode.

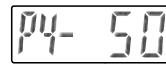

P1: Set value for OUT1(1)
P2: Set value for OUT1(2)
P3: Set value for OUT2(1)
P4: Set value for OUT2(2)

6.2 Output method

• Hysteresis mode (P1 ≥ P2, P3 ≥ P4)

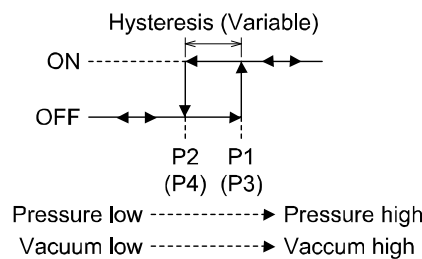

• Window comparator mode (P1 < P2, P3 < P4)

(Hysteresis = 3 digits fixed)

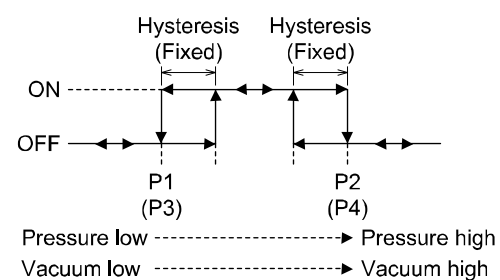

- Hysteresis mode (same as for positive pressure use) When the value of hysteresis is set to 2 digits or less, the switching output might chatter due to fluctuation of the input pressure around its set point.
- Window comparator mode (same as for positive pressure use) since the hysteresis will be 3 digits, separate P1 from P2 (in case of 2-output type, same as for P3 and P4) by 7 digits or more.
* 1 digit is the minimum pressure display unit.

6 Pressure Setting (continued)

6.3 1 Output type with Failure Predictive function

1. Set value input mode

Press the "SET" button to display "P1-50" *1.
The output OUT1(1) set value input mode is selected.
*1: If the set value of P1 is -50.



2. OUT1(1) set value input

Pressing the \blacktriangle button increases the set value.
Pressing the \blacktriangledown button decreases the set value.
Press the "SET" button to save the set value and select the output OUT1(2) set value input mode.
The set value of P2 is displayed.

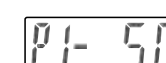

3. OUT1(2) set value input

Pressing the \blacktriangle button increases the set value.
Pressing the \blacktriangledown button decreases the set value.
Press the "SET" button to save the set value and select the failure predictive pressure set value input mode.
The failure predictive set value is displayed.

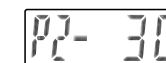

4. Failure predictive pressure set value input

Pressing the \blacktriangle button increases the set value.
Pressing the \blacktriangledown button decreases the set value.
Press the "SET" button to save the set value and select the failure predictive count set value input mode.
The failure predictive count set value is displayed.

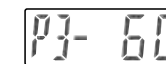

5. Failure predictive count set value input

Pressing the \blacktriangle button increases the set value.
Pressing the \blacktriangledown button decreases the set value.
Press the "SET" button to save the set value and exit this mode.

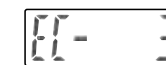

P1: Set value for OUT1(1)

P2: Set value for OUT1(2)

P3: Set value for failure predictive pressure.

EC: Set value for failure predictive count.

6.4 Failure Predictive function

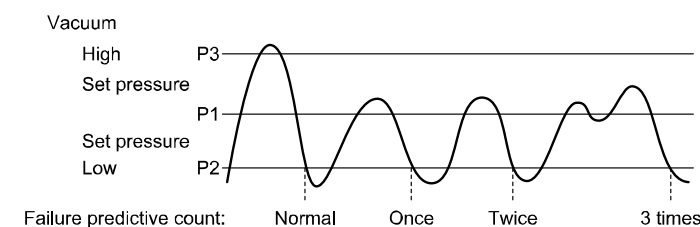

The failure predictive detection counter is incremented when the switch is turned on then is turned off, without the pressure (exceeding P1) not reaching the failure predictive pressure (P3).

The failure predictive detection output is energized when the set failure predictive counter (EC) is incremented consecutively. When the switch is turned ON and the pressure (exceeding P1) exceeds the failure predictive pressure (P3), the failure predictive counter is reset.
(This example shows a case in the hysteresis mode).

7 Other Settings

- Peak Hold mode
- Bottom Hold mode
- RESET button function
- Zero clear function

Refer to the operation manual available on the SMC website (URL: <https://www.smcworld.com>)

8 Error Indication

Error Display	Error Type	Troubleshooting Method
E1 dE	The set data has been changed under some influences.	Press the RESET button and set all data again.
E2 cE1	Load of OUT1 has short-circuited and overcurrent is flowing.	Turn off the power supply and replace the load connected to the OUT1 (black wire).
E2 cE2	Load of OUT2 has short-circuited and overcurrent is flowing.	Turn off the power supply and replace the load connected to the OUT2 (white wire).
E3 PE	Pressure exceeding 0.5 MPa has been applied. (In case of positive pressure, pressure exceeding the rated pressure has been applied.)	Lower the pressure to 0.5 MPa or less. (In case of positive pressure, lower the pressure to the rated pressure or less.)
E4 HP	Compared with the ambient pressure -0.07 MPa (in case of 1 MPa use) or -7 kPa or more (in case of vacuum use or 100 kPa use) has been applied during zero clear.	After adjusting the pressure to the ambient pressure, perform RESET operation.

If the error cannot be reset after the above measures are taken, then please contact SMC.

9 How to Order

Refer to the operation manual on the SMC website (URL: <https://www.smcworld.com>) for How to order information.

10 Outline Dimensions

Refer to the operation manual or catalogue on the SMC website (URL: <https://www.smcworld.com>) for Outline Dimensions.

11 Maintenance

11.1 General Maintenance

⚠ Caution

- Not following proper maintenance procedures could cause the product to malfunction and lead to equipment damage.
- If handled improperly, compressed air can be dangerous.
- Maintenance of pneumatic systems should be performed only by qualified personnel.
- Before performing maintenance, turn off the power supply and be sure to cut off the supply pressure. Confirm that the air is released to atmosphere.
- After installation and maintenance, apply operating pressure and power to the equipment and perform appropriate functional and leakage tests to make sure the equipment is installed correctly.
- If any electrical connections are disturbed during maintenance, ensure they are reconnected correctly and safety checks are carried out as required to ensure continued compliance with applicable national regulations.
- Do not make any modification to the product.
- Do not disassemble the product, unless required by installation or maintenance instructions.

How to reset the product after power cut or forcible de-energizing

The setting of the product is remained as that before power cut or de-energizing. The output condition is also basically recovered to that before power cut or de-energizing, but may change depending on the operating environment. Therefore, check the safety of whole facility before operating the product. If the facility is under accurate control, wait until the product has warmed up (approx. 10 minutes).

11 Maintenance (continued)

• Replacement of filter elements

If element clogging causes deterioration of the adsorption force or slows the response time, stop operation and replace the element.

Filter element part no.: ZX1-FE

Confirm that the filter gasket is seated in the groove before reassembling the parts.

Filter gasket part no.: ZX1-FG

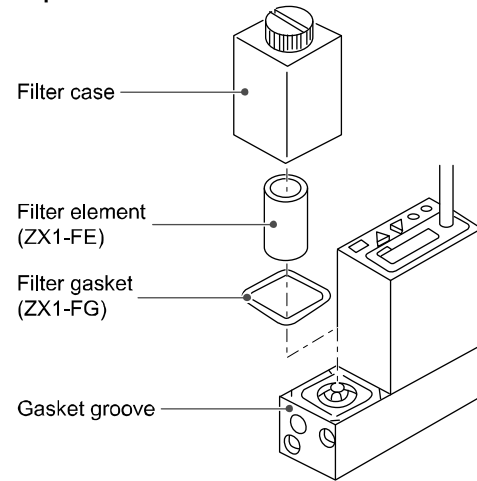

• Filter cases

The case is made of polycarbonate. Therefore, do not use the product in an environment that is exposed to chemicals such as thinners, carbon tetrachloride, chloroform, acetic ester, aniline, cyclohexane, trichloroethylene, sulfuric acid, lactic acid, or water-soluble cutting oil (alkalinic).

12 Limitations of Use

12.1 Limited warranty and Disclaimer/Compliance Requirements

Refer to Handling Precautions for SMC Products.

⚠ Caution

• SMC products are not intended for use as instruments for legal metrology.

Measurement instruments that SMC manufactures or sells have not been qualified by type approval tests relevant to the metrology (measurement) laws of each country.

Therefore, SMC products cannot be used for business or certification ordained by the metrology (measurement) laws of each country.

13 Product Disposal

This product shall not be disposed of as municipal waste. Check your local regulations and guidelines to dispose of this product correctly, in order to reduce the impact on human health and the environment.

14 Contacts

Refer to www.smcworld.com or www.smc.eu for your local distributor / importer.

SMC Corporation

URL: <https://www.smcworld.com> (Global) <https://www.smc.eu> (Europe)
 SMC Corporation, 4-14-1, Sotokanda, Chiyoda-ku, Tokyo 101-0021, Japan
 Specifications are subject to change without prior notice from the manufacturer.
 © 2021 SMC Corporation All Rights Reserved.
 Template DKP50047-F-085M