

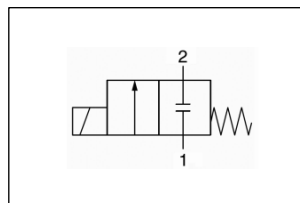

ORIGINAL INSTRUCTIONS

Instruction Manual

Direct operated 2 Port Solenoid Valve
JSXM series (Modular Mounting)

The intended use of this product is to control the downstream fluid supply.

1 Safety Instructions

These safety instructions are intended to prevent hazardous situations and/or equipment damage. These instructions indicate the level of potential hazard with the labels of "Caution," "Warning" or "Danger." They are all important notes for safety and must be followed in addition to International Standards (ISO/IEC)⁽¹⁾, and other safety regulations.

⁽¹⁾ ISO 4414: Pneumatic fluid power - General rules relating to systems.
ISO 4413: Hydraulic fluid power - General rules relating to systems.
IEC 60204-1: Safety of machinery - Electrical equipment of machines. (Part 1: General requirements)
ISO 10218-1: Robots and robotic devices - Safety requirements for industrial robots - Part 1: Robots.

- Refer to product catalogue, Operation Manual and Handling Precautions for SMC Products for additional information.
- Keep this manual in a safe place for future reference.

Caution	Caution indicates a hazard with a low level of risk which, if not avoided, could result in minor or moderate injury.
Warning	Warning indicates a hazard with a medium level of risk which, if not avoided, could result in death or serious injury.
Danger	Danger indicates a hazard with a high level of risk which, if not avoided, will result in death or serious injury.

Warning

- Always ensure compliance with relevant safety laws and standards.
- All work must be carried out in a safe manner by a qualified person in compliance with applicable national regulations.
- If this equipment is used in a manner not specified by the manufacturer, the protection provided by the equipment may be impaired.

Caution

- The product is provided for use in manufacturing industries only. Do not use in residential premises.

2 Specifications

2.1 Valve specifications

Size	20	30	40
Valve construction	Direct operated poppet		
Valve type	Normally closed (N.C.)		
Fluid and fluid temperature [°C]	Air	-10 to 60 (Dew point temperature -10 or less)	
Withstand pressure [MPa]	2.0		
Max. system pressure [MPa]	1.0		
Ambient temperature [°C]	-20 to 60		
Max. operating pressure differential [MPa]	0.7	1.0	
Flow characteristics	Refer to catalogue		
Response time [ms] ^{Note 1)}	Contact SMC		
Duty cycle	100%		
Minimum operating frequency	Once every 30 days		
Maximum operating frequency [Hz] ^{Note 2)}	10		
Lubrication	Not required		

2 Specifications - continued

Impact/Vibration resistance [m/s ²] ^{Note 3)}	150 / 30	
Valve/External leakage [cm ³ /min] (ANR) ^{Note 4)}	Air	1 or less
Enclosure (based on IEC60529)	IP67 (IP65 with DIN connector)	
Mounting orientation	Unrestricted	
Body Material	Aluminium	
Seal Material	NBR, FKM	
Weight [g]	Refer to catalogue	

Table 1.

Note 1) Variable dependent on pressure, voltage fluctuation, piping conditions, etc.
Note 2) Reference value only. Based on a reference value of response time; ON 50 ms, OFF 50 ms. Test in actual application.

Note 3) Impact resistance: No malfunction occurred when it was tested with a drop tester in the axial direction and at right angles to the main valve and armature; in both energized and de-energized states and for every time in each condition. (Values quoted are for a new valve)
Vibration resistance: No malfunction occurred in a one-sweep test between 45 and 2000 Hz. Tests are performed at both energized and de-energized states in the axial direction and at right angles to the main valve and armature. (Values quoted are for a new valve)

Note 4) At 20°C ambient temperature and a pressure differential ≥ 0.01 MPa for air.

2.2 Coil specifications

Size		20	30	40
Rated voltage [V] ^{Note 1)}	AC	24, 48, 100, 110, 120, 200, 220, 230, 240		
	DC		12, 24	
Electrical entry	Grommet, Conduit, DIN, DIN terminal, M12 connector			
Coil insulation type	Class B			
Allowable voltage fluctuation	$\pm 10\%$ of rated voltage			
Allowable leakage voltage	AC	5% or less of rated voltage		
	DC	2% or less of rated voltage		
Apparent power [VA] ^{Note 2), 3)}	AC	8	9.5	
Power consumption [W] ^{Note 2)}	DC	6	8	
Temperature rise [°C] ^{Note 4)}	AC	70		
	DC	65		

Table 2.

Note 1) Grommet with PCB, voltage AC110V or higher is not compatible with CE.
Note 2) Apparent power/Power consumption: The value at ambient temperature of

20°C and when rated voltage is applied (Variation: $\pm 10\%$).

Note 3) There is no difference in the frequency and the inrush and energised apparent power, since a rectifying circuit is used in the AC.

Note 4) Temperature rise is the increase when rated voltage is applied to a valve with an ambient temperature of 20°C. However, it is a reference value because it varies depending on the surrounding environment.

2.3 Special products

Warning

Special products (-X) might have specifications different from those shown in this section. Contact SMC for specific drawings.

3 Installation

3.1 Installation

Warning

- Do not install the product unless the safety instructions have been read and understood.

3.2 Environment

Warning

- Do not use in an environment where corrosive gases, chemicals, salt water or steam are present.
- Do not use in an explosive atmosphere.
- Do not expose to direct sunlight. Use a suitable protective cover.
- Do not install in a location subject to vibration or impact in excess of the product's specifications.
- Do not mount in a location exposed to radiant heat that would result in temperatures in excess of the product's specifications.
- Products compliant with IP65 and IP67 enclosures are protected against dust and water, however, these products cannot be used in water.
- Products compliant with IP65 and IP67 enclosures satisfy the specifications by mounting each product properly. Be sure to read the Specific Product Precautions for each product.
- This valve is for indoor use only.
- For low temperature operation, take appropriate measures to prevent solidification or freezing of drainage and moisture, etc.

3 Installation - continued

- In case of use in environments such as cold regions, high dew point temperature with low ambient temperature and high flow rates:
 - Drain water from pipeline when equipment is off.
 - Apply thermal insulating material or use a heater, etc (avoid on coil portion).
 - Installation of a dryer on the inlet.
- Employ suitable protective measures in locations where there is contact with oil or welding spatter, etc.

3.3 Piping

Caution

- For the handling of our fittings, please refer to Fittings and Tubing Precautions in the Handling Precautions for SMC products.
- When using fittings other than SMC fittings, follow the instructions given by the fitting manufacturer.
- Tightening torque for steel pipe piping. When piping to the valve, tighten with the following appropriate torque.

Port size (Rc, NPT)	Tightening torque [N·m]
1/8	7 to 9
1/4	12 to 14
3/8	22 to 24
1/2	28 to 30

Table 3.

- Before connecting piping make sure to clean up chips, cutting oil, dust etc.
- When installing piping or fittings, ensure sealant material does not enter inside the port. When using seal tape, leave 1.5 to 2 threads exposed on the end of the pipe/fitting.
- Avoid connecting ground lines to piping, as this may cause electric corrosion of the system.
- When connecting piping to the product, avoid mistakes regarding the supply ports etc
- When connecting tubes using the one-touch fitting, provide tube length with sufficient margin. Refer to Specific Precautions in the catalogue for more details.
- When connecting piping/fitting to the valve, clamp the metal part of the body with a vise, etc. See figure 1.

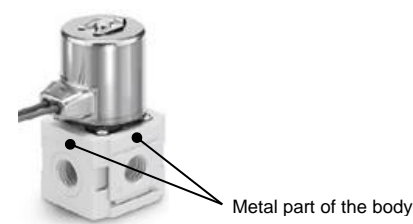

Figure 1. Clamp area of valve

Warning

- To prevent uncontrolled tube movement, install protective covers or fasten tubes securely in place.
- If using tube piping, secure the product to a permanent fixture. Do not suspend it by the tubing.

3.4 Fluid supply

Warning

- Use clean air. If the compressed air supply includes chemicals, synthetic materials (including organic solvents), salinity, corrosive gas etc., it can lead to damage or malfunction.
- If there is a possibility of back pressure being applied to the valve, take countermeasures such as mounting a check valve on the downstream side of the valve.

Caution

- Compressed air that includes excessive drainage may cause malfunction of valves and other pneumatic equipment. To prevent this, install an air dryer or after cooler, etc.
- The use of a fluid that contains foreign objects can cause problems such as malfunction and seal failure by promoting wear of the valve seat and armature and by sticking to the sliding parts of the armature etc. Install a suitable filter (5 μ m or less) immediately upstream from the valve.
- If excessive carbon powder is generated by the compressor, it may adhere to the inside of the valves and cause a malfunction. Install mesh separators upstream of the valves to eliminate it.

3 Installation - continued

3.5 Mounting - General

Warning

- Ensure sufficient space for maintenance activities. Avoid sources of vibration or adjust the distance from the body to a minimum length so that resonance will not occur.
- Do not apply external force to the coil section: When tightening fittings, apply a wrench or other tool to the outside of the piping connection parts.
- Do not warm the coil assembly with a heat insulator, etc. Use tape, heaters, etc, for freeze prevention on the piping and body only. They can cause the coil to burn out.
- Valve becomes hot during and after energization. Do not touch it with bare hands as it may cause burns.

Caution

- Painting and coating: Warnings or specifications printed or labelled on the product should not be erased, removed or covered up.

3.5.1 Modular mounting

The JSXM valves can be individually mounted (figure 1) or assembled in a modular form (figure 2) using the connection spacers (figure 3).

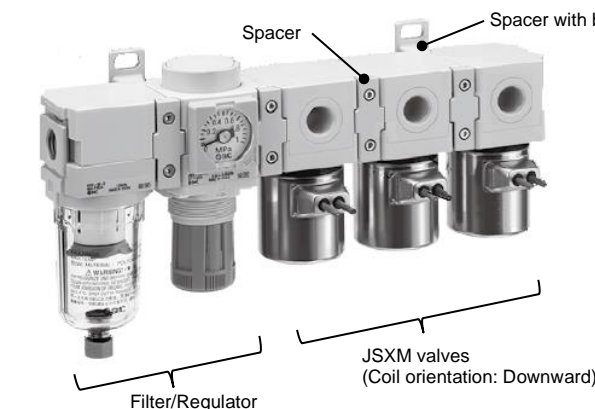

Figure 2. Modular assembly example

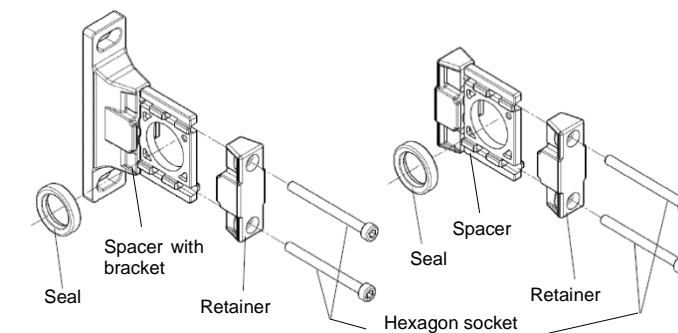

Figure 3. Spacer with bracket and spacer

- Assembly
 - A spacer or spacer with bracket is used to combine 2 modules, see figure 2 and Table 4.
 - Ensure seal is located correctly in the spacer, then, one at a time, slide the recessed parts of the 2 modules onto the raised parts of the spacer. Seals are available as spare parts, see Table 5.
 - Once the 2 modules are correctly mounted onto the spacer, install the retainer and secure it with the 2 hexagon socket head cap screws to the correct torque, see Table 6.

- Disassembly is the reverse of the assembly.

Warning

- Before disassembly, ensure any residual pressure is released from the system.
- After replacement, confirm that the product satisfies specific functions and check for external leakage before operation.

3 Installation - continued

Spacer (bracket) part numbers

Size	Spacer	Spacer with bracket
200 (JSXM20)	Y200-D	Y200T-D
300 (JSXM30)	Y300-D	Y300T-D
400 (JSXM30)	Y400-D	Y400T-D

Table 4.

Spacer seals (HNBR)

Size	Seal part number
Y200(T)-D	Y220P-050S
Y300(T)-D	Y320P-050S
Y400(T)-D	Y420P-050S

Table 5.

Retainer tightening torque

Size	Tightening torque [N·m]
Y200#-D	0.36 ±0.036
Y300#-D, Y400#-D	1.2 ±0.05

Table 6.

3.6 Lubrication

Caution

This product does not require lubrication in service.

3.7 Electrical connection

Warning

- The solenoid valve is an electrical product. For safety, install an appropriate fuse and circuit breaker before use according to local regulations. When using a number of solenoid valves, installing one fuse on the primary side is not enough. To protect the device more safely, select and install a fuse for each circuit.

Caution

- Avoid mis-wiring, as this can cause malfunction and damage to the product.
- Use electrical wire with cross sectional area 0.5 to 1.25 mm².
- Use electrical circuits that do not generate chattering in their contacts.
- When a surge from the solenoid affects the electrical circuitry, install a surge absorber, etc., in parallel with the solenoid or use the product with a surge voltage suppressor.

- Use voltage that is within ±10% of the rated voltage. In case of direct current, if the response time is important, ensure that voltage is within ±5% of the rated value. (The voltage drop is the value in the lead wire section connecting the coil.)
- Do not bend or pull lead wires and cables repeatedly.
- Do not apply more than 10 N of force to the lead wires or damage may occur.
- Do not bend the lead wires beyond 90° with a radius of less than 20mm or damage may occur. See figure 4.

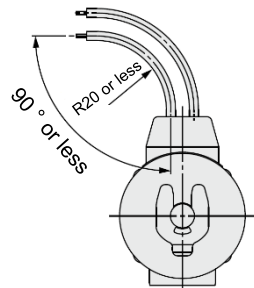

Figure 4. Lead wire bending

3.7.1 Grommet

Lead wire AWG20, outer diameter 2.6mm.

Voltage type	Lead wire colour	
	1	2
Grommet	DC (12,24 V)	Black
	DC (12, 24 V)	Red
Grommet with PCB	AC (100 V)	Blue
	AC (24,48 V)	Grey

Table 7.

Note: There is no polarity.

3 Installation - continued

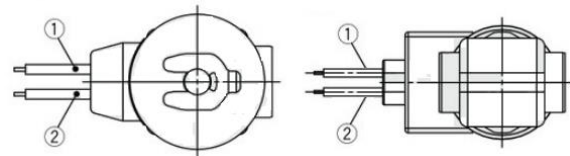

Figure 5. Grommet and Grommet with PCB

3.7.2 Conduit

Lead wire AWG18, outer diameter 2.8mm.

Voltage type	Conduit wire colour		
	1	2	3 (ground wire)
DC	Black	Red	Green / Yellow
AC 100V	Blue	Blue	Green / Yellow
AC 200V	Red	Red	Green / Yellow
Other AC	Grey	Grey	Green / Yellow

Table 8.

Note: There is no polarity.

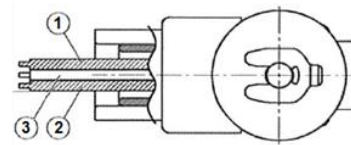

Figure 6. Conduit

3.7.3 DIN terminal

- Use a cord with an outside cable diameter of Ø6 to Ø12 mm.
- Tighten screws and fittings according to Figure 7.
- If an outside cable diameter of Ø9 to Ø12 mm is used, remove the internal parts of the rubber seal before using.

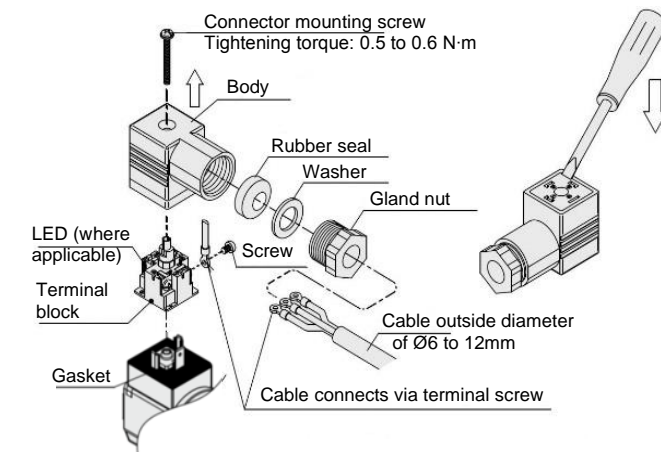

Figure 7. DIN connector construction

- Conforms to DIN EN 175301-803, 18 mm, Form A.

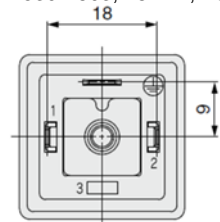

Figure 8. DIN terminal - Form A

3 Installation - continued

Caution

Internal connections are shown below. Make connections to the power supply accordingly.

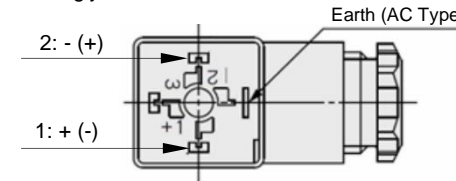

Figure 9. DIN connector pins

Note: There is no polarity.

Contact	1	2
DIN Terminal	+ (-)	- (+)

Table 9.

3.7.4 M12 connector

Valve side			
DC (non-polar)		AC	
2. Unused	1. Unused	2. Unused	1. Earth
3. Power	4. Power	3. Power	4. Power
Cable side			
DC (non-polar)		AC	
1. Unused	2. Unused	1. Earth	2. Unused
4. Power	3. Power	4. Power	3. Power

Table 10.

Caution

- The valve achieves IP67 rating when used with IP67 rated female connector (with cable). Note that the valve shouldn't be used in water.
- Tighten the connector by hand (at 0.39 to 0.49 N·m), not with a tool which may damage the connector.
- Do not apply repeated bending force, tensile force or heavy load to the cable.
- Do not pull the connector or cable unnecessarily.
- When installing the valve, do not bend the cable at the root from the connector body.

3.8 Electrical circuits

3.8.1 DC circuits

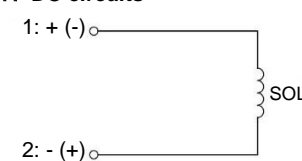

Figure 10. Grommet without electrical option

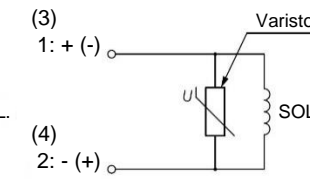

Figure 11. Grommet / DIN terminal / Conduit with surge voltage suppressor / M12 connector (3,4)

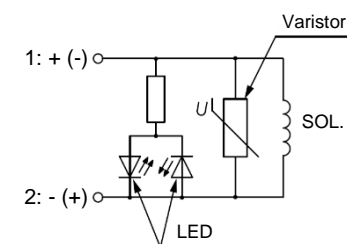

Figure 12. DIN terminal with LED and surge voltage suppressor

3 Installation - continued

3.8.2 AC circuits

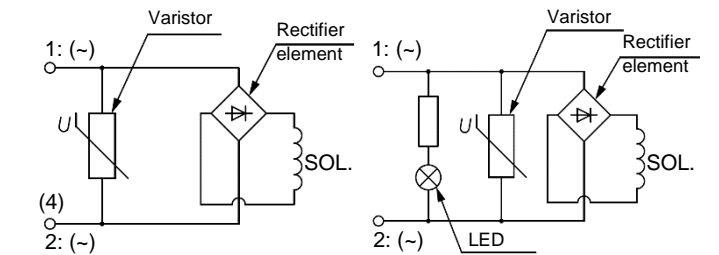

Figure 13. Grommet / DIN terminal / Conduit with surge voltage suppressor / M12 connector (3,4)

3.9 Residual voltage

Caution

- If a varistor or diode surge voltage suppressor is used, the suppressor arrests the back EMF voltage from the coil to approximately 1 V (AC type) or 60 V (DC type).
- Ensure the transient voltage is within the specification of the host controller.
- Valve response time is dependent on surge suppression method selected.

3.10 Countermeasure for external surge voltage

Caution

- At times of sudden interruption of the power supply, the energy stored in a large inductive device may cause non-polar type valves in a de-energised state to switch.
- When installing a breaker circuit to isolate the power, install a surge absorption diode across the output of the breaker.

3.11 Extended period of continuous energization

Warning

- The solenoid coil will generate heat when continuously energized, so

- avoid installing in an enclosed space. Install in a well-ventilated area.
- Do not touch the coil while it is being energized or immediately after energization.

4 How to Order

Refer to catalogue for 'How to Order' or to product drawings for special products.

5 Outline Dimensions

Refer to catalogue and special drawings for outline dimensions.

6 Maintenance

6.1 General maintenance

Caution

- Not following proper maintenance procedures could cause the product to malfunction and lead to equipment damage.
- If handled improperly, compressed fluids can be dangerous. Shut off the fluid supply and release the fluid pressure in the system.
- Make sure that temperature of the valve has reduced sufficiently before removing the valve.
- After installation and maintenance, apply operating pressure and power to the equipment and perform appropriate functional and leakage tests to make sure the equipment is installed correctly. If leakage increases or equipment does not operate properly, stop operation.
- If any electrical connections are disturbed during maintenance, ensure they are reconnected correctly and safety checks are carried out as required to ensure continued compliance with applicable national regulations.
- Do not make any modification to the product.
- Do not disassemble the product, unless required by installation or maintenance instructions.
- Periodic maintenance of filter and strainer:
 - Replace filter element every 1 year or when the pressure drop becomes 0.1 MPa, whichever comes first.
 - Wash strainer when the pressure drop becomes 0.1 MPa.

6 Maintenance - continued

- Exhaust the drainage from the air filters periodically.
If the drainage overflows and enters the air line, this may cause malfunction of pneumatic equipment.
- Switch valves at least once every 30 days to prevent malfunction. Also, in order to use it under the optimum state, conduct a regular inspection once every 6 months.
- In the case of long-term storage after use, thoroughly remove all moisture to prevent rust and deterioration of rubber materials, etc.

7 Limitations of Use

7.1 Limited warranty and disclaimer/compliance requirements

Refer to Handling Precautions for SMC Products.

7.2 Low temperature operation

Warning

- The valve can be used in an ambient temperature of -20°C. However, take measures to prevent freezing or solidification of impurities, etc.
- A high dew point in low ambient temperature or a high flow rate may cause freezing. In such cases, take measures to prevent freezing by, for example, installing an air dryer or keeping the body warm.

7.3 Holding of pressure

Warning

Since valves are subject to air leakage, they cannot be used for applications such as holding pressure (including vacuum) in a system.

7.4 Cannot be used as an emergency shut-off valve

Warning

This product is not designed for safety applications such as an emergency shut-off valve. If the valves are used in this type of system, other reliable safety assurance measures should be adopted.

7.5 Normally closed valves

Warning

Although the valves are normally closed (IN and OUT port blocked), and flow is blocked from Port 1 to Port 2, the fluid will not be blocked if Port 2

pressure is greater than Port 1 pressure, and fluid will flow from Port 2 to Port 1.

7.6 Leakage voltage

Caution

Ensure that any leakage voltage caused by the leakage current when the switching element is OFF causes $\leq 2\%$ of the rated voltage across the valve for DC coil and $\leq 5\%$ for AC coils.

8 Product Disposal

This product shall not be disposed of as municipal waste. Check your local regulations and guidelines to dispose this product correctly, in order to reduce the impact on human health and the environment.

9 Contacts

Refer to www.smcworld.com or www.smc.eu for your local distributor/importer.

SMC Corporation

URL : <https://www.smcworld.com> (Global) <https://www.smc.eu> (Europe)
SMC Corporation, 4-14-1, Sotokanda, Chiyoda-ku, Tokyo 101-0021, Japan
Specifications are subject to change without prior notice from the manufacturer.
© 2021 SMC Corporation All Rights Reserved.
Template DKP50047-F-085M