



ORIGINAL INSTRUCTIONS

Instruction Manual

Auto switch (Solid state) – Direct mounting  
Series D-M9#A#

(Complies with the basic safety principles in accordance with ISO13849).



The intended use of the auto switch is to detect and control the position of an actuator using magnetic detection.

Validated D-M9#A# components according to ISO13849:

For the part numbers of validated D-M9#A# products refer to Document No. D-\*S-URA1001.

1 Safety Instructions

These safety instructions are intended to prevent hazardous situations and/or equipment damage. These instructions indicate the level of potential hazard with the labels of "Caution," "Warning" or "Danger." They are all important notes for safety and must be followed in addition to International Standards (ISO/IEC) <sup>1)</sup>, and other safety regulations.

- <sup>1)</sup> ISO 4414: Pneumatic fluid power - General rules relating to systems.
- ISO 4413: Hydraulic fluid power - General rules relating to systems.
- IEC 60204-1: Safety of machinery - Electrical equipment of machines. (Part 1: General requirements)
- ISO 10218-1: Manipulating industrial robots -Safety. etc.

- Refer to product catalogue, Operation Manual and Handling Precautions for SMC Products for additional information.
- Keep this manual in a safe place for future reference.

	<b>Caution</b>	Caution indicates a hazard with a low level of risk which, if not avoided, could result in minor or moderate injury.
	<b>Warning</b>	Warning indicates a hazard with a medium level of risk which, if not avoided, could result in death or serious injury.
	<b>Danger</b>	Danger indicates a hazard with a high level of risk which, if not avoided, will result in death or serious injury.

**Warning**

- Always ensure compliance with relevant safety laws and standards.
- All work must be carried out in a safe manner by a qualified person in compliance with applicable national regulations.
- This product is class A equipment intended for use in an industrial environment. There may be potential difficulties in ensuring electromagnetic compatibility in other environments due to conducted or radiated disturbances.
- Refer to the operation manual on the SMC website (URL: <https://www.smcworld.com>) for more Safety Instructions.

2 Specifications

Model	D-M9NA(V)	D-M9PA(V)	D-M9BA(V)
Wiring	3-wire		2-wire
Output	NPN	PNP	-
Supply voltage	4.5 to 28 VDC		-
Current consumption	10 mA max.		-
Load voltage	28 VDC max.	-	10 to 28 VDC
Load current	40 mA max.		2.5 to 40 mA
Internal volt drop	0.8 V max. (at 10 mA) 2.0 V max. (at 40 mA)		4.0 V max.
Current leakage	100 µA max. (at 24 VDC)		0.8 mA max.
Operation time	1.0 ms max.		
Indication light	LED ON: Red (operating position) LED ON: Green (optimum position)		
Lead wire	φ2.6 oilproof vinyl cable, 0.15 mm <sup>2</sup>		
Impact resistance	1000 m/s <sup>2</sup>		
Insulation resistance	50 MΩ or more at 500 VDC mega		
Withstand voltage	1000 VAC for 1 minute (between case and cable)		
Ambient temperature	-10 to 60°C		
Protection structure	IP67 to IEC 60529, JISC 0920		

3 Names of Individual parts

- D-M9BA / D-M9NA / D-M9PA

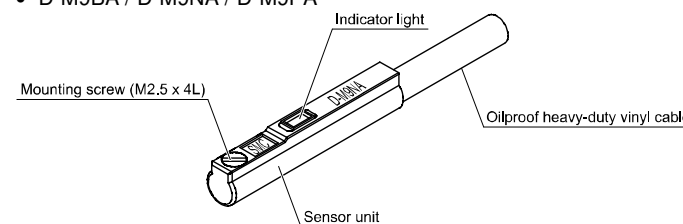

- D-M9BAV  
D-M9NAV  
D-M9PAV

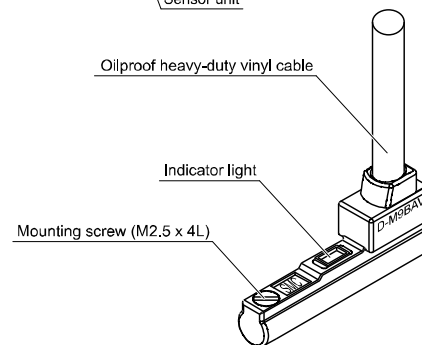

4 Installation

4.1 Installation

**Warning**

- Do not install the product unless the safety instructions have been read and understood.

4.2 Design and Selection

- 1) Confirm the specifications.  
Read the specifications carefully and use the product correctly. The product may be damaged or malfunction if it is used outside of the specification range.
- 2) Take precautions when multiple actuators are used close together.  
When multiple auto switch actuators are used in close proximity, magnetic field interference may cause the switches to malfunction. Maintain a minimum actuator separation of 40 mm.
- 3) Pay attention to the length of time that a switch is ON at an intermediate stroke position.  
When an auto switch is placed at an intermediate position of the stroke and a load is driven at the time the piston passes, the auto switch will operate, but if the speed is too great the operating time will be short and the load may not operate correctly. The maximum detectable piston speed is:

$$V \text{ (mm/s)} = \frac{\text{Auto switch operating range (mm)}}{\text{Load operating time (ms)}} \times 1000$$

4 Installation (continued)

- 4) Keep wiring as short as possible  
Although long wire length does not affect the switch function, it is recommended to keep it to 100 m or less.
- 5) Do not use a load that generates surge voltage.  
Although a zener diode for surge protection is connected at the output side of a solid state auto switch, damage may still occur if the surge is applied repeatedly. When a load such as a relay or solenoid which generates surge is directly driven, use a type of switch with built in surge protection.
- 6) Caution for use in an interlock circuit  
When an auto switch is used for an interlock signal requiring high reliability, devise a double interlock system by providing a mechanical protection function, or by using another switch (sensor) together with the auto switch.  
Perform periodic maintenance and confirm proper operation.
- 7) Ensure sufficient clearance for maintenance activities.  
When designing an application, be sure to allow sufficient clearance for maintenance and inspections.

4.3 Mounting and Adjustment

- 1) Do not drop or bump the product.  
Do not drop, bump or apply excessive impact (1000 m/s<sup>2</sup> or more) while handling. Although the body of the switch may not appear damaged, the inside of the switch could be damaged and cause a malfunction.
- 2) Do not carry an actuator by the auto switch lead wires.  
This may not only cause broken lead wires, but it may cause internal elements of the switch to be damaged by the stress.
- 3) Mount switches using the correct tightening torque.  
The tightening torque of the mounting screw is 0.05 to 0.15 N·m. If a switch is tightened beyond the tightening torque range, the mounting screw, mounting bracket or switch may be damaged. On the other hand, tightening below the tightening torque range may allow the switch to slip out of position.
- 4) Mount a switch at the centre of the operating range.  
Adjust the auto switch mounting position so that the piston stops at the centre of the operating range (the range in which the switch is

- ON).  
The mounting position shown in the catalogue indicates the optimum position at the end of stroke. If mounted at the end of the operating range (around the borderline of ON and OFF) operation may be unstable.
- 5) The auto switch ON and OFF position operates with a hysteresis. If the hysteresis causes a problem, please consult with SMC.

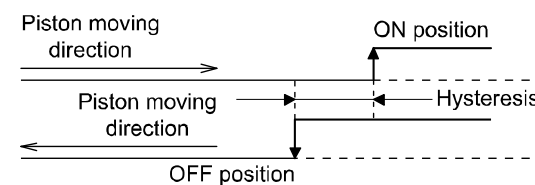

4.4 Mounting

Each actuator has a specified mounting bracket type. Mounting depends on the actuator type and tube I.D. Please refer to the actuator catalogue.  
When an auto switch is mounted for the first time, ensure that the actuator is the type with a magnet built-in, and prepare a mounting bracket corresponding to the actuator.  
M2.5 mounting screw tightening torque 0.05 to 0.1 N·m.

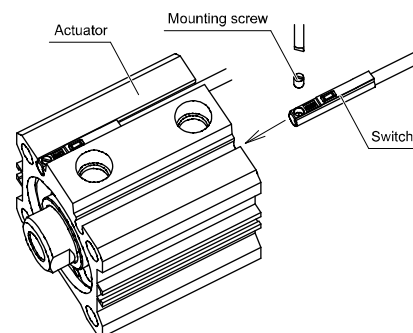

4 Installation (continued)

4.5 Setting the Detecting position

Set the actuator at the stroke end. Set the switch in the area where the auto switch Red LED is ON (Detecting actuator end position). For 2 colour type auto switches the Green LED turns ON to indicate the optimum position.  
Based on dimensions A and B in the actuator catalogue, set the switch. Tighten the mounting screw to the required torque.

4.6 Wiring

- 1) Avoid repeatedly bending or stressing lead wires.  
Broken lead wires can result from wiring layouts which repeatedly apply bending stress or stretching force to the lead wires.
- 2) Confirm proper insulation of wiring.  
Check that there is no faulty wiring insulation (contact with other circuits, ground fault, improper insulation between terminals, etc.) Damage may occur due to excess current flow into a switch.
- 3) Do not route wiring with power lines or high voltage lines.  
Avoid parallel wiring or wiring in the same conduit with these lines. Control circuits containing auto switches may malfunction due to noise.
- 4) Do not allow short circuit of loads.  
The auto switch does not have built-in short circuit protection. Note that if a load is short circuited, the switch will be instantly damaged because of excess current flow into the switch.
- 5) Avoid incorrect wiring.  
If wiring is incorrect the switch will be damaged.

4.7 Wiring diagram

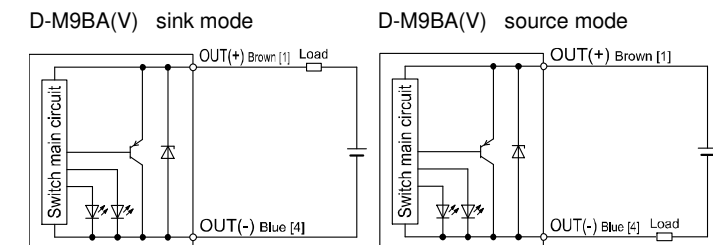
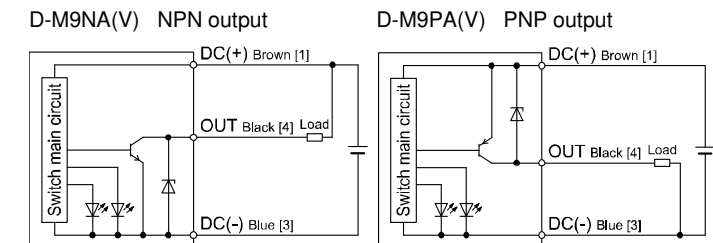

The number shown in brackets [ ] in the wiring diagram indicates the pin number of a pre-wired connector.

4.8 Connector pin assignment

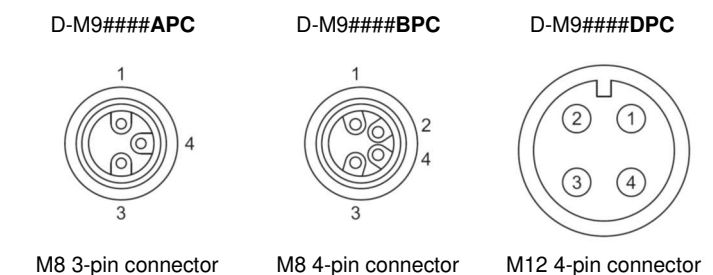

## 4 Installation (continued)

### 4.9 Environment

#### Warning

- Do not use in an environment where oil, corrosive gases, chemicals, salt water or steam are present.
- Do not install in a location subject to vibration or impact in excess of the product specifications.
- Do not mount in a location exposed to radiant heat that would result in temperatures in excess of the product specification.
- Do not use in an area where a magnetic field is generated. Auto switches can malfunction or magnets inside actuators can become demagnetized.
- Do not use in an environment where the auto switch will be continually exposed to water.
- Do not use in an environment with temperature cycles.
- Avoid accumulation of iron waste or close contact with magnetic substances. A large amount of accumulated iron waste such as machining chips or spatter may cause the auto switch to malfunction.

## 5 Maintenance

### 5.1 General Maintenance

#### Caution

- Not following proper maintenance procedures could cause the product to malfunction and lead to equipment damage.
- If handled improperly, compressed air can be dangerous.
- Maintenance of pneumatic systems should be performed only by qualified personnel.
- Before performing maintenance, turn off the power supply and be sure to cut off the supply pressure. Confirm that the air is released to atmosphere.
- After installation and maintenance, apply operating pressure and power to the equipment and perform appropriate functional and leakage tests to make sure the equipment is installed correctly.
- If any electrical connections are disturbed during maintenance, ensure they are reconnected correctly and safety checks are carried out as required to ensure continued compliance with applicable national regulations.

- Do not make any modification to the product.
- Do not disassemble the product, unless required by installation or maintenance instructions.
- Perform the following maintenance periodically in order to prevent possible danger due to unexpected auto switch malfunction.
  - Securely tighten switch mounting screws. If screws become loose or the mounting position is dislocated, re-tighten them after readjusting the mounting position.
  - Confirm that there is no damage to lead wires. To prevent faulty insulation, replace switches or repair lead wires, etc., if damage is discovered.

## 6 How to Order

Refer to the operation manual or catalogue on the SMC website (URL: <https://www.smcworld.com>) for How to order information.

## 7 Outline dimensions

Refer to the operation manual or catalogue on the SMC website (URL: <https://www.smcworld.com>) for outline dimensions.

## 8 Limitations of Use

**8.1 Limited warranty and Disclaimer/Compliance Requirements**  
Refer to Handling Precautions for SMC Products.

## 9 Product disposal

This product should not be disposed of as municipal waste. Check your local regulations and guidelines to dispose of this product correctly, in order to reduce the impact on human health and the environment.

## 10 Troubleshooting

When detection failure occurs check the switch based on the flow chart.

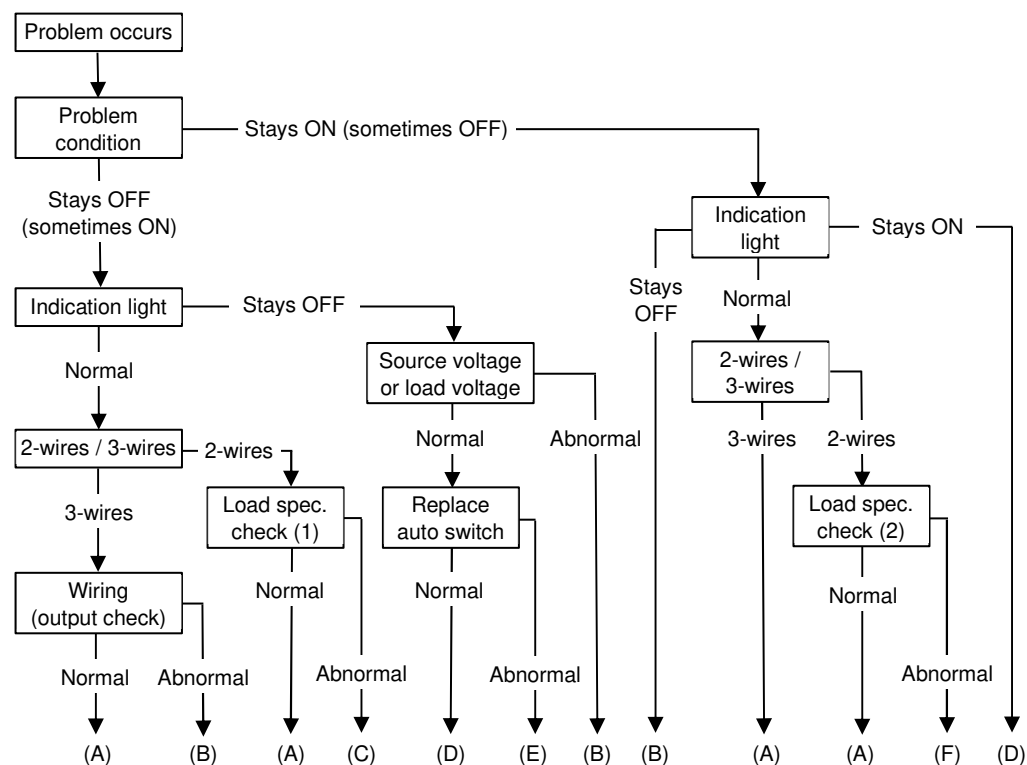

- (A) = Auto switch output failure (replace)
- (B) = Check wiring and correct fault
- (C) = Replace auto switch 2 wires -> 3 wires.
- (D) = Auto switch failure.
- (E) = Replace actuator. Detectable magnetic field inadequate (or no magnet)
- (F) = Replace PLC input board or replace auto switch 2 wires -> 3 wires.

Load spec. check (1): ON voltage > Load voltage – internal volt drop  
Load spec. check (2): OFF current > Leak current

## 11 Contacts

Refer to [www.smcworld.com](https://www.smcworld.com) or [www.smc.eu](https://www.smc.eu) for your local distributor / importer.

# SMC Corporation

URL: <https://www.smcworld.com> (Global) <https://www.smc.eu> (Europe)  
SMC Corporation, 4-14-1, Sotokanda, Chiyoda-ku, Tokyo 101-0021, Japan  
Specifications are subject to change without prior notice from the manufacturer.  
© 2022 SMC Corporation All Rights Reserved.  
Template DKP50047-F-085M