

All Stainless Steel Vacuum Ejector

ZH□□-X267

RoHS

- All stainless steel (SCS13: Equivalent to stainless steel 304)
- Sealant not required
- Maximum operating temperature: 260°C
- Grease-free

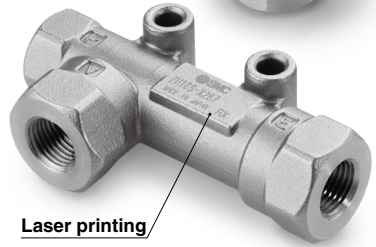
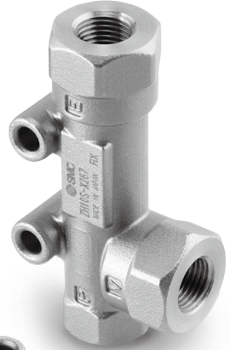

Adsorption of wet workpieces

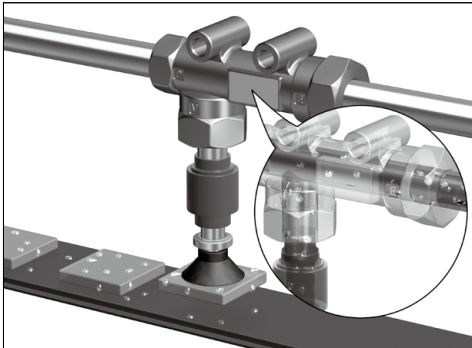

Mixing 2 types of inert gas

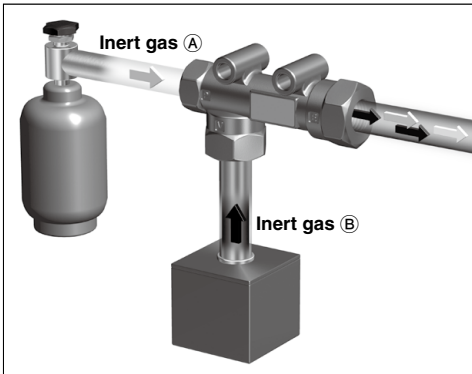

An environment where it is exposed to water

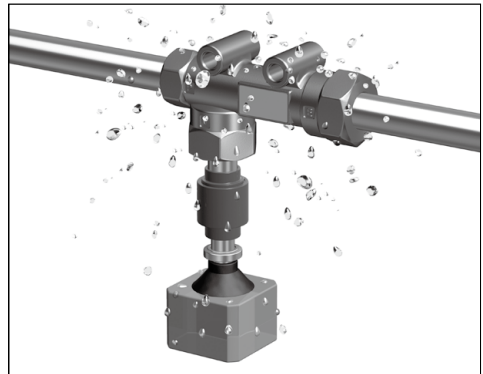

All Stainless Steel Vacuum Ejector ZH□□-X267



How to Order

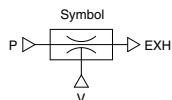

ZH 05 S - X267

● Nozzle nominal size

05	ø0.5
07	ø0.7
10	ø1.0

● Vacuum pressure

S	-88 kPa
L	-48 kPa

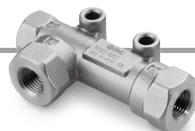

Specifications

Model	ZH05S-X267	ZH05L-X267	ZH07S-X267	ZH07L-X267	ZH10S-X267	ZH10L-X267
Nozzle nominal size [mm]	0.5		0.7		1.0	
Vacuum pressure [kPa] ^{Note)}	-88	-48	-88	-48	-88	-48
Suction flow rate [L/min (ANR)] ^{Note)}	5	8	12	20	24	34
Air consumption [L/min (ANR)] ^{Note)}	13		23		46	
Standard supply pressure [MPa]	0.45					
Body material	SCS13					
Nozzle material	Stainless steel 304					
Diffuser material	Stainless steel 304					
Maximum operating pressure [MPa]	0.6					
Ambient and fluid temperature [°C]	-5 to 260 (with no freezing or condensation)					
Fluid	Air, Inert gas					
Weight [g]	85		87		89	

Note) Values are measured at ambient temperature of 20°C and the standard supply pressure based on SMC's measurement conditions. They may change depending on the operating ambient temperature, atmospheric pressure during use and measurement method.

Exhaust Characteristics/Flow Rate Characteristics (Representative value)

The flow rate characteristics correspond to a supply pressure of 0.45 MPa.

ZH05S-X267

Exhaust characteristics

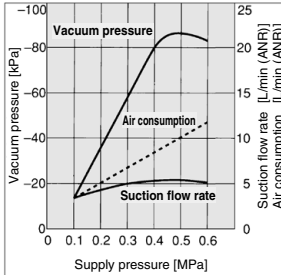

Flow rate characteristics

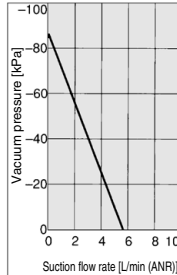

ZH05L-X267

Exhaust characteristics

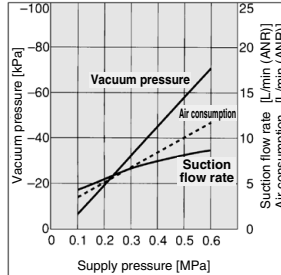

Flow rate characteristics

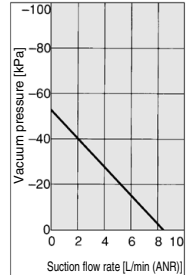

ZH07S-X267

Exhaust characteristics

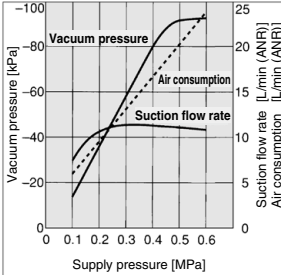

Flow rate characteristics

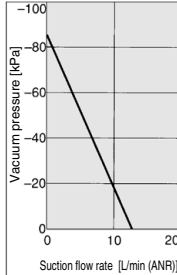

ZH07L-X267

Exhaust characteristics

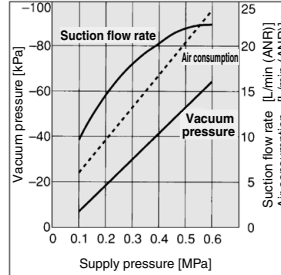

Flow rate characteristics

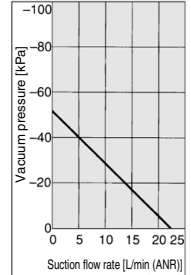

ZH10S-X267

Exhaust characteristics

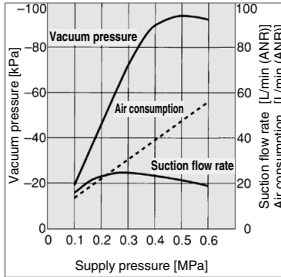

Flow rate characteristics

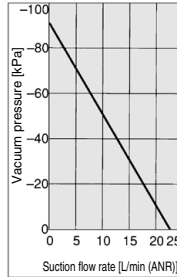

ZH10L-X267

Exhaust characteristics

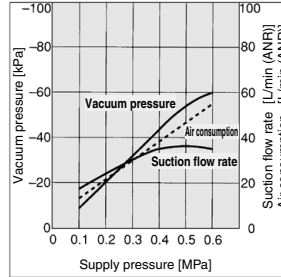

Flow rate characteristics

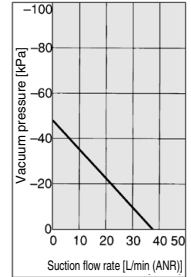

How to Read Flow Rate Characteristics Graph

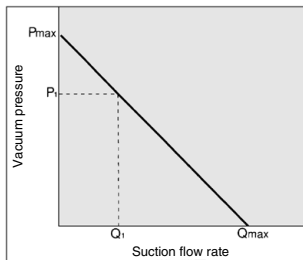

Flow rate characteristics are expressed in ejector vacuum pressure and suction flow rate. If suction flow rate changes, a change in vacuum pressure will also be expressed. Normally this relationship is expressed in ejector standard use.

In graph, P_{max} is maximum vacuum pressure and Q_{max} is maximum suction flow rate. The valves are specified according to catalog use. Changes in vacuum pressure are expressed in the order below.

1. When ejector suction port is covered and made airtight, suction flow rate becomes 0 and vacuum pressure is at maximum value (P_{max}).
2. When suction port is opened gradually, air can flow (leak) through, suction flow rate

increases, but vacuum pressure decreases. (condition P_1 and Q_1)

3. When suction port is opened further, suction flow rate moves to maximum value (Q_{max}), but vacuum pressure is near 0. (atmospheric pressure).

When vacuum port (vacuum piping) has no leakage, vacuum pressure becomes maximum, and vacuum pressure decreases as leakage increases. When leakage value is the same as maximum suction flow rate, vacuum pressure is near 0.

When permeable or leaky workpiece must be adsorbed, please note that vacuum pressure will not be high.

Dimensions

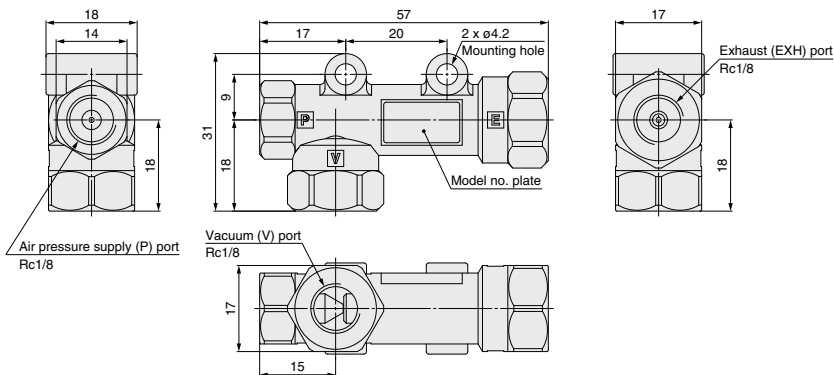

Example of Application Circuit

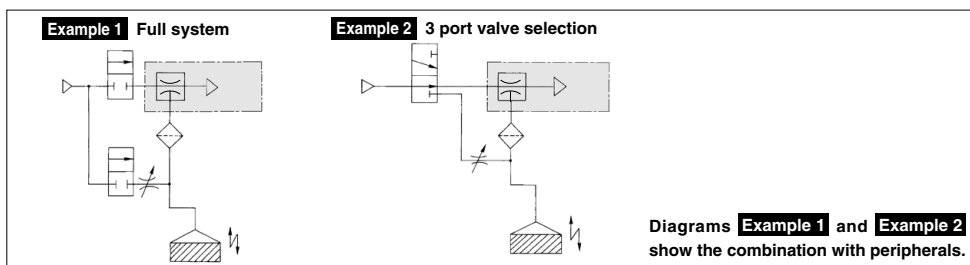

⚠ Caution

Handling of Application Circuits

- Countermeasures for power outages**
Select a supply valve for the ejector that is normally open or one that is equipped with a self-holding function.
- Using a small-diameter picking nozzle**
For picking electronic parts or small precision parts, if the picking nozzle is approximately $\phi 1$ mm in diameter, the vacuum remains high by being restricted by the nozzle. As a result, it will not be possible to verify it with the vacuum switch. In such a case, it is necessary to use an ejector that is suited to the nozzle and to select a vacuum switch with a favorable hysteresis and precision.
- Considerable leakage from the suction surface**
If a workpiece is made of porous material or if

there is air leakage from the area between the pad and the workpiece, use a nozzle with a large diameter and a large suction flow rate. If the amount of leakage is known based on the effective sectional area of the side with the leakage, the vacuum pressure can be estimated in accordance with the ejector's flow rate characteristics.

- Suction filter**
To protect the ejectors and valves from dust, the use of a suction filter (ZFA, ZFB, ZFC series) is recommended.
- Use of a vacuum switch**
It is recommended that verification be made with a vacuum switch as much as possible.
- Vacuum release valve**
To serve as a vacuum release valve, use a 2

port or 3 port valve that can be used under vacuum condition. For 3 port valves, the exhaust port should be plugged. In addition, add a needle valve that can regulate the flow rate of the vacuum releasing air. Use the atmospheric pressure or a positive pressure for the vacuum releasing pressure.

- Common exhaust** **Exhaust pipe with enough capability**
For common exhaust as shown right, use an exhaust pipe big enough to prevent exhaust resistance.

