

# Angular Type Air Gripper

## MHC2/MHCA2/MHCM2 Series

ø6, ø7

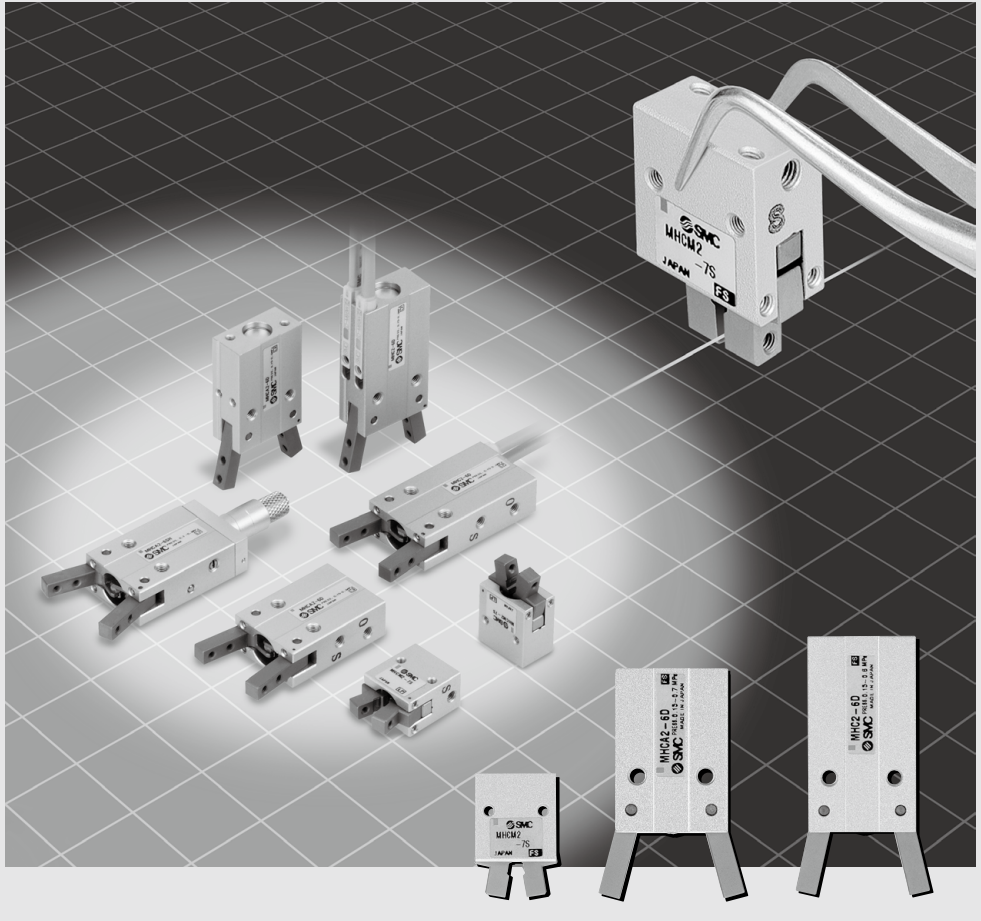

- MHZ
- MHF
- MHL
- MHR
- MHK
- MHS
- MHC**
- MHT
- MHY
- MHW
- X□
- MRHQ
- MA
- D-□

# Angular type air gripper

## MHC2/MHCA2/MHCM2 Series

### MHC2-6□

Auto switch is attachable.

48 mm x 20 mm x 10 mm 22 g

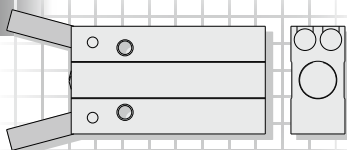

### MHCA2-6□

Short body.

41 mm x 20 mm x 10 mm 19 g

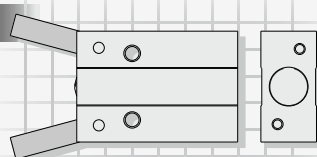

### MHCM2-7S

Smallest size and lightest weight in MHC series.

23 mm x 15 mm x 10 mm 9.5 g

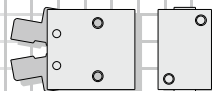

### Body option (Only for MHCA2-6)

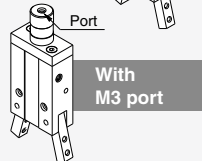
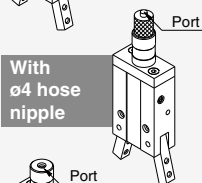
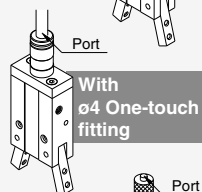
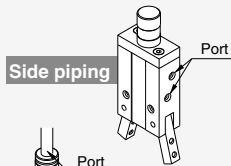

### Variations



Model	MHC2-6□	MHCA2-6□	MHCM2-7S
Cylinder bore	ø6	ø6	ø7
Action	Double acting Single acting (Normally open)		Single acting (Normally open)
Opening/Closing angle (Both sides)	30° to -10°		20° to -7°
Holding moment (at 0.5 MPa)	0.038 N·m (Double acting) 0.024 N·m (Single acting)		0.017 N·m
Repeat ability	±0.02 mm		
Maximum operating frequency	180 c. p.m		
Weight	22 g (Note)	19 g	9.5 g
Auto switch	Solid state auto switch (2-wire, 3-wire)	—	—
Body option	—	End boss type	—

Note) Not including auto switch weight.



# MHC2/MHCA2/MHCM2 Series Specific Product Precautions

Be sure to read this before handling the products.

## Mounting

### Warning

1. **Tighten the screw within the specified torque range when mounting the air gripper.**  
Tightening with a torque above the limit can cause malfunction, while insufficient tightening can cause slippage and dropping.

### How to Mount Air Grippers

#### Axial Mounting (Body tapped)

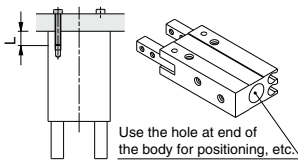

Model	Bolt	Max. tightening torque N·m	Max. screw-in depth L mm
MHCA2-6	M2 x 0.4	0.15	6
MHCM2-7S	M2 x 0.4	0.15	4

Note) MHC2-6 is not compatible with axial mounting.

Model	Hole dia. mm	Hole depth mm
MHCA2-6	$\phi 7H_8^{+0.022}$	1.5

#### Vertical mounting (Body tapped)

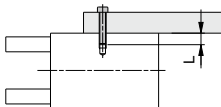

Model	Bolt	Max. tightening torque N·m	Max. screw-in depth L mm
MHCA2-6	M2 x 0.4	0.15	4

Note) MHC2-6 and MHCM2-7S are not compatible with vertical mounting.

#### Lateral mounting (Body tapped, body through-hole)

##### ● Body tapped

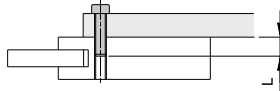

Model	Bolt	Max. tightening torque N·m	Max. screw-in depth L mm
MHC2-6	M3 x 0.5	0.88	10
MHCA2-6	M3 x 0.5	0.88	10
MHCM2-7S	M2 x 0.4	0.15	10

##### ● Body through-hole

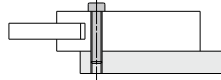

Model	Bolt	Max. tightening torque N·m
MHC2-6	M2.5 x 0.45	0.49
MHCA2-6	M2.5 x 0.45	0.49

Note) MHCM2-7S is not compatible with body through-hole mounting.

### Warning

2. **Do not scratch or dent the air gripper by dropping or bumping it when mounting.**  
Slight deformation can cause inaccuracy or a malfunction.
3. **Tighten the screw within the specified torque range when mounting the attachment.**  
Tightening with a torque above the limit can cause malfunction, while insufficient tightening can cause slippage and dropping.

### How to Mount Attachment to the Finger

Make sure to mount the attachments on fingers with the tightening torque in the table below by using bolts, etc., for the female threads on fingers.

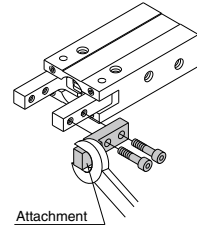

Attachment

Model	Bolt	Max. tightening torque N·m
MHC□2-6	M2 x 0.4	0.15
MHCM2-7S	M2 x 0.4	0.15

## Operating Environment

### Caution

#### Use caution for the anti-corrosiveness of finger guide section.

Except for some models, martensitic stainless steel is used for the finger. However, be aware that its anti-corrosion performance is inferior to austenitic stainless steel. In particular, the finger might be rusted in an environment where water droplets are adhered to it due to dew condensation.

MHZ

MHF

MHL

MHR

MHK

MHS

MHC

MHT

MHY

MHW

-X□

MRHQ

MA

D-□

# MHC2/MHCA2/MHCM2 Series

## Model Selection

### Model Selection

#### Selection Procedure



#### Step 1 Confirmation of Gripping Force

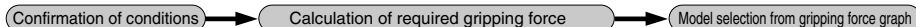

Example Workpiece mass: **0.01 kg**

Gripping method: External gripping

**Model selection criteria with respect to workpiece mass**

- Although differences will exist depending on factors such as shape and the coefficient of friction between the attachments and workpieces, select a model which will provide a gripping force 10 to 20 times the <sup>(Note 1)</sup> weight of the workpiece.
- (Note 1) Refer to the model selection illustration for more information.
- Furthermore, in cases with high acceleration or impact, etc., it is necessary to allow an even greater margin of safety.

**Example:** When it is desired to set the gripping force at 10 times or more the workpiece weight.  
 Required gripping force =  $0.01 \text{ kg} \times 10 \times 9.8 \text{ m/s}^2$   
 = Approx. 0.98 N or more

Length of gripping point: **25mm**

Operating pressure: **0.4MPa**

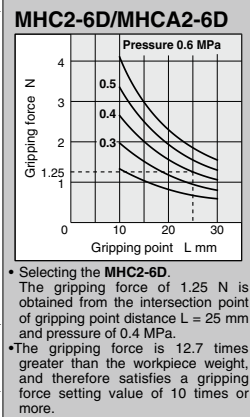

#### Model Selection Illustration

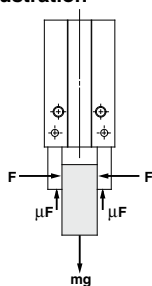

When gripping a workpiece as in the figure to the left and with the following definitions,  
**F:** Gripping force (N)  
**μ:** Coefficient of friction between attachments and workpiece  
**m:** Workpiece mass (kg)  
**g:** Gravitational acceleration (= 9.8 m/s<sup>2</sup>)  
**mg:** Workpiece weight (N)

the conditions under which the workpiece will not drop are

$$2 \times \mu F > mg$$

↑  
Number of fingers

and therefore,

$$F > \frac{mg}{2 \times \mu}$$

With "a" as the safety margin, F is determined as follows:

$$F = \frac{mg}{2 \times \mu} \times a$$

#### Gripping force at least 10 to 20 times the workpiece weight

The "10 to 20 times or more of the workpiece weight" recommended by SMC is calculated with the safety margin of a = 4, which allows for impacts that occur during normal transportation, etc.

When $\mu = 0.2$	When $\mu = 0.1$
$F = \frac{mg}{2 \times 0.2} \times 4$	$F = \frac{mg}{2 \times 0.1} \times 4$
$= 10 \times mg$	$= 20 \times mg$

10 x workpiece weight

20 x workpiece weight

(Note) - Even in cases where the coefficient of friction is greater than  $\mu = 0.2$ , for safety reasons, SMC recommends selecting a gripping force which is at least 10 to 20 times the workpiece weight.  
 - It is necessary to allow a greater safety margin for high accelerations and strong impacts, etc.

## Step 1 Effective Gripping Force: MHC□2 Series External Gripping Force

- Expressing the effective gripping force  
The effective gripping force shown in the graphs to the right is expressed as F, which is the thrust of one finger when both fingers and attachments are in full contact with the workpiece as shown in the figure below.

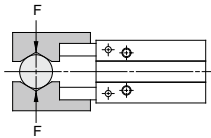

### External Gripping

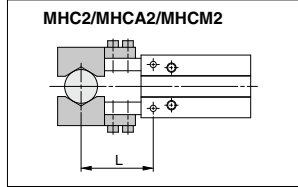

- If there is an overhang, please consult with SMC.

### MHC2-6D/MHCA2-6D

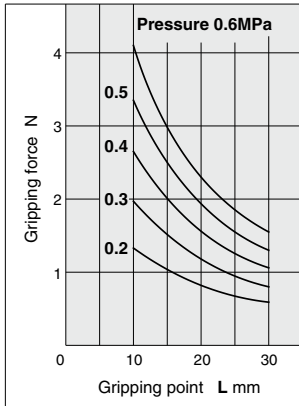

### MHC2-6S/MHCA2-6S

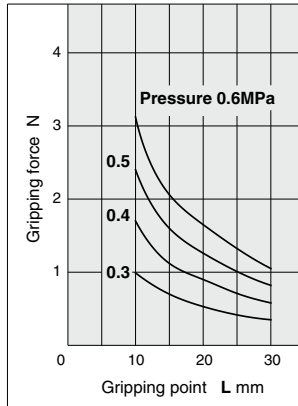

### MHCM2-7S

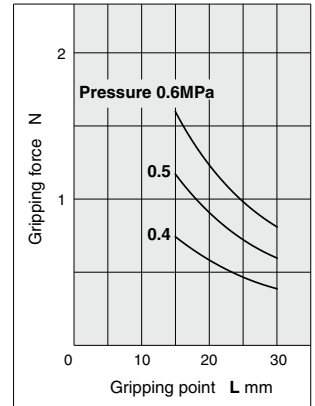

MHZ

MHF

MHL

MHR

MHK

MHS

**MHC**

MHT

MHY

MHW

-X□

MRHQ

MA

D-□

# MHC2/MHCA2/MHCM2 Series

## Step 2 Confirmation of Inertial Moment of Attachment

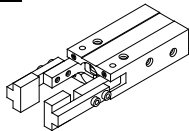

Confirm the inertial moment of one of the two attachments.  
For example, in calculating the inertial moment of an attachment in the picture on the left, divide it into 2 rectangular parallelepipeds, A part and B part.

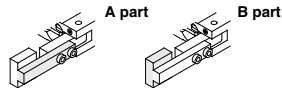

Procedure	Formula	Example						
<p><b>1. Calculate the operating conditions and attachment dimensions.</b></p>	<p><b>A part</b></p> <p><b>B part</b></p>	<p>Operating equipment: MHC2-6D  <b>a</b> = 20 (mm)  <b>b</b> = 3 (mm)  <b>c</b> = 4 (mm)  <b>d</b> = 4 (mm)  <b>e</b> = 5 (mm)  <b>f</b> = 6 (mm)</p>						
<p><b>2. Calculate the inertial moment of the attachment.</b></p>	<p><b>A part</b></p> <p>Weight calculation  <math>m_1 = a \times b \times c \times \text{Relative density}</math></p> <p>Inertial moment around Z1 axis  <math>I_{z1} = \{m_1 (a^2 + b^2) / 12\} \times 10^{-6}</math></p> <p>Inertial moment around Z axis  <math>I_A = I_{z1} + m_1 f_1^2 \times 10^{-6}</math></p> <p><b>B part</b></p> <p>Weight calculation  <math>m_2 = d \times e \times f \times \text{Relative density}</math></p> <p>Inertial moment around Z2 axis  <math>I_{z2} = \{m_2 (d^2 + e^2) / 12\} \times 10^{-6}</math></p> <p>Inertial moment around Z axis  <math>I_B = I_{z2} + m_2 f_2^2 \times 10^{-6}</math></p> <p>Thus, the total inertial moment is <math>I = I_A + I_B</math>  <small>(*: Unit conversion constant)</small></p>	<p>Assuming the attachment material is aluminium alloy (relative density=2.7),  <math>r_1 = 16.4</math> (mm).</p> <p><math>m_1 = 20 \times 3 \times 4 \times 2.7 \times 10^{-6}</math>  <math>= 6.48 \times 10^{-4}</math> (kg)</p> <p><math>I_{z1} = \{6.48 \times 10^{-4} \times (20^2 + 3^2) / 12\} \times 10^{-6}</math>  <math>= 2.21 \times 10^{-8}</math> (kg·m<sup>2</sup>)</p> <p><math>I_A = 2.21 \times 10^{-8} + 6.48 \times 10^{-4} \times 16.4^2 \times 10^{-6}</math>  <math>= 0.20 \times 10^{-6}</math> (kg·m<sup>2</sup>)</p> <p><math>r_2 = 23.5</math>(mm)</p> <p><math>m_2 = 4 \times 5 \times 6 \times 2.7 \times 10^{-6}</math>  <math>= 3.24 \times 10^{-4}</math> (kg)</p> <p><math>I_{z2} = \{3.24 \times 10^{-4} \times (4^2 + 5^2) / 12\} \times 10^{-6}</math>  <math>= 1.11 \times 10^{-9}</math> (kg·m<sup>2</sup>)</p> <p><math>I_B = 1.11 \times 10^{-9} + 3.24 \times 10^{-4} \times 23.5^2 \times 10^{-6}</math>  <math>= 0.18 \times 10^{-6}</math> (kg·m<sup>2</sup>)</p> <p><math>I = 0.20 \times 10^{-6} + 0.18 \times 10^{-6}</math>  <math>= 0.38 \times 10^{-6}</math> (kg·m<sup>2</sup>)</p>						
<p><b>3. Confirm from the table that the inertial moment of one attachment is within the allowable range.</b></p>	<p><b>MHC2-6D/MHCA2-6D</b></p> <table border="1"> <tr> <td>Finger opening and closing speed</td> <td>Allowable inertial moment of attachment</td> </tr> <tr> <td>Without speed controller</td> <td><math>0.5 \times 10^{-6}</math> Kg·m<sup>2</sup></td> </tr> <tr> <td>With speed controller 3/4 to 1 and 1/2 reverse rotation from fully close state</td> <td><math>1.5 \times 10^{-6}</math> Kg·m<sup>2</sup></td> </tr> </table> <p>Attachment inertial moment &gt; Allowable inertial moment</p>	Finger opening and closing speed	Allowable inertial moment of attachment	Without speed controller	$0.5 \times 10^{-6}$ Kg·m <sup>2</sup>	With speed controller 3/4 to 1 and 1/2 reverse rotation from fully close state	$1.5 \times 10^{-6}$ Kg·m <sup>2</sup>	<p>Attachment inertial moment <math>0.38 \times 10^{-6}</math> (kg·m<sup>2</sup>)          &lt; Allowable inertial moment without speed controller <math>0.5 \times 10^{-6}</math> (kg·m<sup>2</sup>)</p> <p>Therefore, the attachment can be used without a speed controller.</p>
Finger opening and closing speed	Allowable inertial moment of attachment							
Without speed controller	$0.5 \times 10^{-6}$ Kg·m <sup>2</sup>							
With speed controller 3/4 to 1 and 1/2 reverse rotation from fully close state	$1.5 \times 10^{-6}$ Kg·m <sup>2</sup>							

### Symbol

Symbol	Definition	Unit
Z	Central axis of finger rotation	—
Z1	Axis which contains center of gravity of attachment A part and is parallel to Z	—
Z2	Axis which contains center of gravity of attachment B part and is parallel to Z	—
I	Total inertial moment of attachment	kg·m <sup>2</sup>
Iz1	Inertial moment around Z1 axis of attachment A part	kg·m <sup>2</sup>
Iz2	Inertial moment around Z2 axis of attachment B part	kg·m <sup>2</sup>
IA	Inertial moment around Z axis of attachment A part	kg·m <sup>2</sup>
IB	Inertial moment around Z axis of attachment B part	kg·m <sup>2</sup>
m1	Weight of attachment A part	kg
m2	Weight of attachment B part	kg
r1	Distance between axes Z and Z1	mm
r2	Distance between axes Z and Z2	mm

### Limiting Range of Attachment Inertial Moment

#### MHC2-6D/MHCA2-6D

Finger opening and closing speed	Allowable inertial moment of attachment	Weight (Guide)
Without speed controller <sup>Note)</sup>	0.5 x 10 <sup>-6</sup> kg·m <sup>2</sup>	2 g or less
With speed controller 3/4 to 1 and 1/2 reverse rotation from fully close state	1.5 x 10 <sup>-6</sup> kg·m <sup>2</sup>	3.5 g or less

#### MHC2-6S/MHCA2-6S

Finger opening and closing speed	Allowable inertial moment of attachment	Weight (Guide)
Without speed controller <sup>Note)</sup>	0.5 x 10 <sup>-6</sup> kg·m <sup>2</sup>	2 g or less
With speed controller 3/4 to 2 reverse rotation from fully close state	1.5 x 10 <sup>-6</sup> kg·m <sup>2</sup>	3.5 g or less

#### MHCM2-7S

Finger opening and closing speed	Allowable inertial moment of attachment	Weight (Guide)
Without speed controller <sup>Note)</sup>	0.3 x 10 <sup>-6</sup> kg·m <sup>2</sup>	2 g or less
With speed controller 1/2 to 1 3/4 reverse rotation from fully close state	1.0 x 10 <sup>-6</sup> kg·m <sup>2</sup>	3.3 g or less

\* Applicable speed controller ——— Air gripper direct connection type AS1211F-M3  
 Use a meter-in type.  
 Note) In the case of MHCM2-7S, provide a run off space because the speed controller protrudes from the body top surface by 0.6 mm.

Note) Sometimes the workpiece may not be gripped precisely because of excessive speed in finger opening and closing. Therefore, use a meter-in type speed controller to adjust the finger opening and closing speed.

MHZ
MHF
MHL
MHR
MHK
MHS
MHC
MHT
MHY
MHW
-X□
MRHQ
MA
D-□

# Angular Type Air Gripper

## MHC2-6/MHCA2-6 Series

ø6

### How to Order

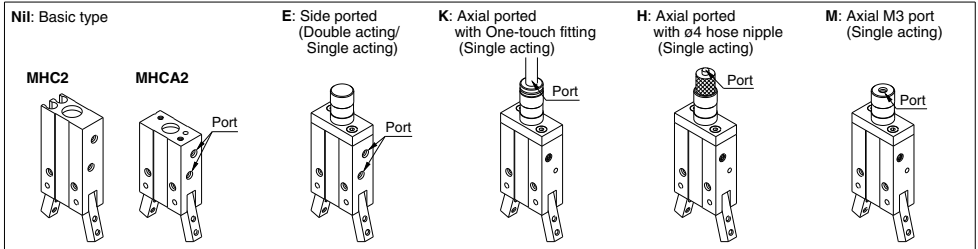
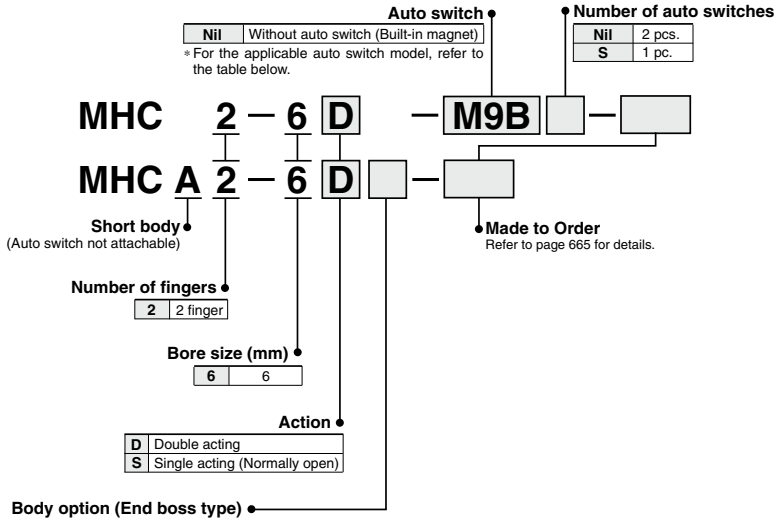

### Applicable Auto Switches

Refer to pages 797 to 850 for further information on auto switches.

Type	Special function	Electrical entry	Indicator light	Wiring (Output)	Load voltage		Auto switch model		Lead wire length (m)*			Pre-wired connector	Applicable load
					DC	AC	Perpendicular	In-line	0.5 (Nil)	1 (M)	3 (L)		
Solid state auto switch	—	Grommet	Yes	3-wire (NPN)	5 V,	—	<b>M9NV</b>	<b>M9N</b>	●	●	○	○	IC circuit
				3-wire (PNP)	12 V		<b>M9PV</b>	<b>M9P</b>	●	●	○	○	
				2-wire	12 V		<b>M9BV</b>	<b>M9B</b>	●	●	○	○	
				3-wire (NPN)	5 V,		<b>M9NWV</b>	<b>M9NW</b>	●	●	○	○	
				3-wire (PNP)	12 V		<b>M9PWV</b>	<b>M9PW</b>	●	●	○	○	
				2-wire	12 V		<b>M9BWW</b>	<b>M9BW</b>	●	●	○	○	
	Diagnosis (2-color indicator)	Grommet	Yes	Yes	3-wire (NPN)	5 V,	<b>M9NAV**</b>	<b>M9NA**</b>	○	○	●	○	IC circuit
					3-wire (PNP)	12 V	<b>M9PAV**</b>	<b>M9PA**</b>	○	○	○	●	
					2-wire	12 V	<b>M9BAV**</b>	<b>M9BA**</b>	○	○	○	●	
					3-wire (NPN)	5 V,			○	○	○	○	
					3-wire (PNP)	12 V			○	○	○	○	
					2-wire	12 V			○	○	○	○	

\*\* Water resistant type auto switches can be mounted on the above models, but in such case SMC cannot guarantee water resistance.

\* Lead wire length symbols: 0.5 m ..... Nil (Example) M9N

\* Auto switches marked with "○" are made to order specification.

1 m ..... M (Example) M9NM

3 m ..... L (Example) M9NL

5 m ..... Z (Example) M9NZ

Note) When using the 2-color indicator type, please make the setting so that the indicator is lit in red to ensure the detection at the proper position of the air gripper.



# Angular Type Air Gripper **MHC2-6/MHCA2-6 Series**



## Symbol

Double acting:  
External grip

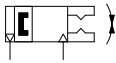

Single acting/ Normally open:  
External grip



**Made to Order**  
[Click here for details](#)

Symbol	Specifications/Description
-X4	Heat resistance (100°C)
-X5	Fluororubber seal
-X53	EPDM seal/Fluorine grease
-X56	Axial piping type
-X63	Fluorine grease
-X64	Finger: Side Tapped Mounting
-X65	Finger: Through-hole mounting
-X79	Grease for food processing machines, Fluorine grease
-X79A	Grease for food processing machines
-X81A	Anti-corrosive treatment of finger

## Moisture Control Tube IDK Series



When operating an actuator with a small diameter and a short stroke at a high frequency, the dew condensation (water droplet) may occur inside the piping depending on the conditions.

Simply connecting the moisture control tube to the actuator will prevent dew condensation from occurring. For details, refer to [the IDK series in the Best Pneumatics No.6.](#)

## Specifications

Fluid		Air
Operating pressure	Double acting	0.15 to 0.6 MPa
	Single acting: Normally open	0.3 to 0.6 MPa
Ambient and fluid temperature		-10 to 60°C
Repeatability		±0.02 mm
Maximum operating frequency		180 c.p.m
Lubrication		Non-lube
Action		Double acting, Single acting (Normally open)
Auto switch (Option) <sup>Note)</sup>		Solid state auto switch (3-wire, 2-wire)

Note) Refer to pages 797 to 850 for further information on auto switches.

## Model

Action	Model	Cylinder bore (mm)	Gripping moment <sup>(1)</sup> (Effective value) N-m	Opening/Closing angle (Both sides)	Weight <sup>(2)</sup> (g)
Double acting	MHC2-6D	6	0.038	30° to -10°	22
	MHCA2-6D	6			19
Single acting (Normally open)	MHC2-6S	6	0.024	30° to -10°	22
	MHCA2-6S	6			19

Note 1) At the pressure of 0.5 MPa

Note 2) Excluding the auto switch weight.

## Option

### ●Body Option/End Boss Type

Symbol	Piping port location	Type of piping port	Applicable model	
		MHCA2-6	Double acting	Single acting
Nil	Basic type	M3 x 0.5	●	●
E	Side ported	M3 x 0.5	●	●
K	Axial ported	With ø4 One-touch fitting	—	●
H		With ø4 hose nipple	—	●
M		M3 x 0.5	—	●

MHZ

MHF

MHL

MHR

MHK

MHS

MHC

MHT

MHY

MHW

-X□

MRHQ

MA

D-□

# MHC2-6/MHCA2-6 Series

## Construction

### MHC2-6

#### Double acting/With fingers open

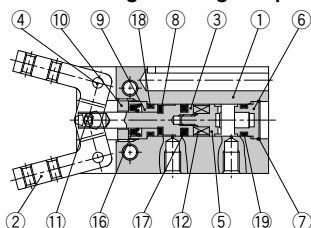

#### Double acting/With fingers closed    Single acting

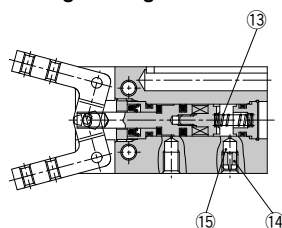
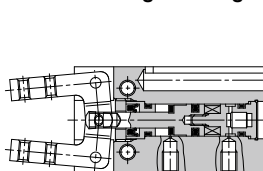

### Component Parts

No.	Description	Material	Note
1	<b>Body</b>	Aluminum alloy	Hard anodized
2	<b>Finger</b>	Stainless steel	Heat treatment
3	<b>Piston</b>	Stainless steel	
4	<b>Lever shaft</b>	Stainless steel	Nitriding
5	<b>Magnet holder</b>	Stainless steel	
6	<b>Cap</b>	Aluminum alloy	Hard anodized
7	<b>Clip</b>	Stainless steel	
8	<b>Bumper</b>	Urethane rubber	
9	<b>Holder</b>	Brass	Electroless nickel plated
10	<b>Holder lock</b>	Stainless steel	

No.	Description	Material	Note
11	<b>Needle roller</b>	High carbon chromium bearing steel	
12	<b>Magnet</b>	—	Nickel plated
13	<b>N.O. spring</b>	Piano wire	Zinc chromated
14	<b>Exhaust plug</b>	Brass	Electroless nickel plated
15	<b>Exhaust filter</b>	Resin	
16	<b>Rod seal</b>	NBR	
17	<b>Piston seal</b>	NBR	
18	<b>Gasket</b>	NBR	
19	<b>Gasket</b>	NBR	

### Replacement Parts

Description	Kit no.	Main parts	Note
<b>Seal kit</b>		Please contact SMC to replace seal kit	

Replacement part/Grease pack part no.: GR-S-005 (5 g)

### MHCA2-6 (Short body type)

#### Double acting/With fingers open

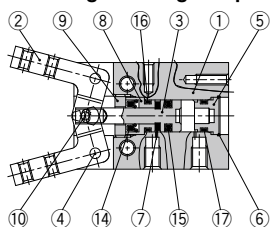

#### Double acting/With fingers closed    Single acting

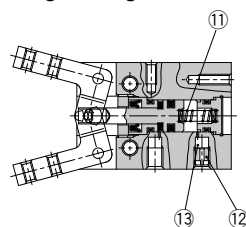
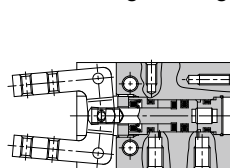

### Component Parts

No.	Description	Material	Note
1	<b>Body</b>	Aluminum alloy	Hard anodized
2	<b>Finger</b>	Stainless steel	Heat treatment
3	<b>Piston</b>	Stainless steel	
4	<b>Lever shaft</b>	Stainless steel	Nitriding
5	<b>Cap</b>	Aluminum alloy	Hard anodized
6	<b>Clip</b>	Stainless steel	
7	<b>Bumper</b>	Urethane rubber	
8	<b>Holder</b>	Brass	Electroless nickel plated
9	<b>Holder lock</b>	Stainless steel	

No.	Description	Material	Note
10	<b>Needle roller</b>	High carbon chromium bearing steel	
11	<b>N.O. spring</b>	Piano wire	Zinc chromated
12	<b>Exhaust plug</b>	Brass	Electroless nickel plated
13	<b>Exhaust filter</b>	Resin	
14	<b>Rod seal</b>	NBR	
15	<b>Piston seal</b>	NBR	
16	<b>Gasket</b>	NBR	
17	<b>Gasket</b>	NBR	

### Replacement Parts

Description	Kit no.	Main parts	Note
<b>Seal kit</b>		Please contact SMC to replace seal kit	

Replacement part/Grease pack part no.: GR-S-010 (10 g)

## Dimensions

### MHC2-6□

4 x M2 x 0.4 through  
Thread for attachment  
mounting

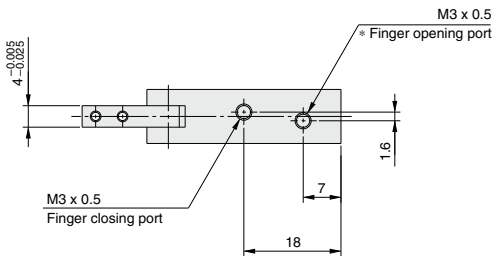
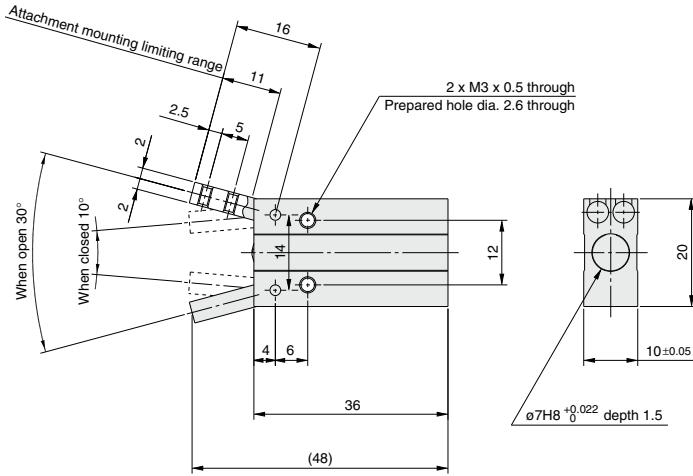
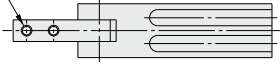

\* In the case of MHC2-6S, finger opening port is a breathing hole.

MHZ
MHF
MHL
MHR
MHK
MHS
<b>MHC</b>
MHT
MHY
MHW
-X□
MRHQ
MA
D-□

# MHC2-6/MHCA2-6 Series

## Dimensions

### MHCA2-6□ (Short body type)

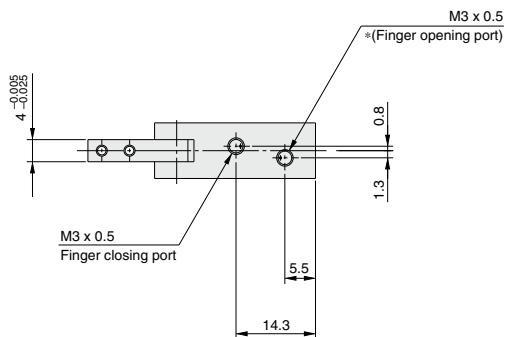
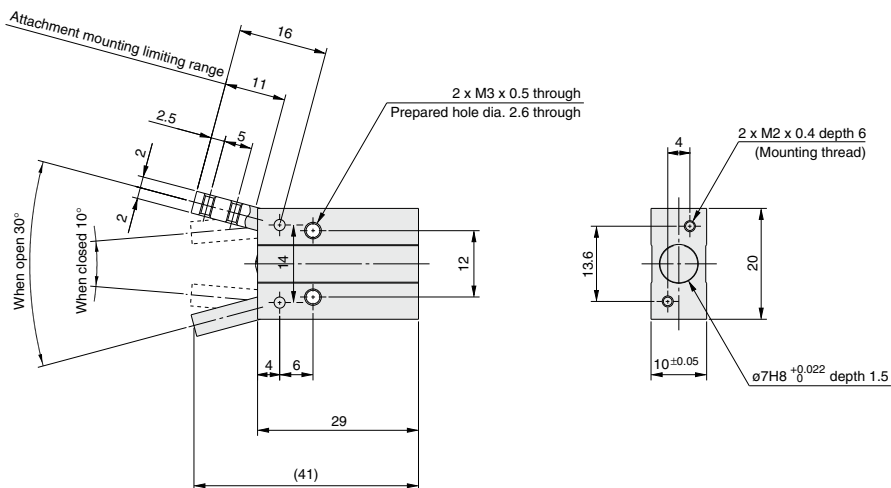
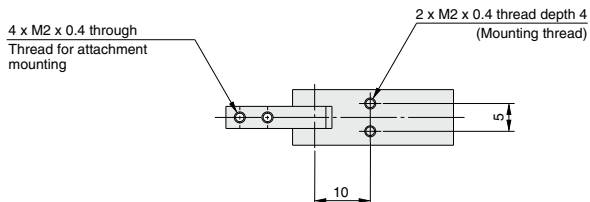

\* In the case of MHCA2-6S, finger opening port is a breathing hole.

# MHCA2 Series

# Body Option: End Boss Type

## Applicable Model

Symbol	Piping port location	Type of piping port	Applicable model	
			Double acting	Single acting
E	Side ported	M3 x 0.5	●	●
H	Axial ported	With ø4 hose nipple	—	●
K		With ø4 One-touch fitting	—	●
M		M3 x 0.5	—	●

## Side Ported [E]

### MHCA2-6□E

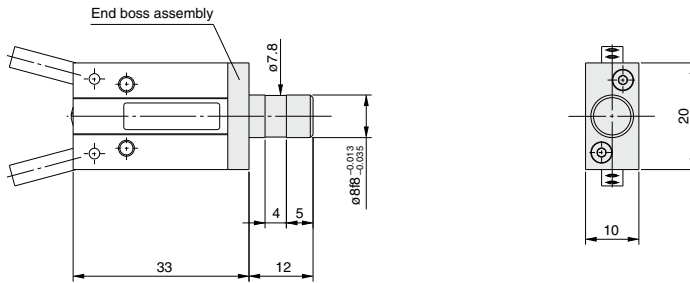

\* The specifications and dimensions not given above are identical with those of the standard type.

## Axial Ported (With hose nipple) [H]

### MHCA2-6SH

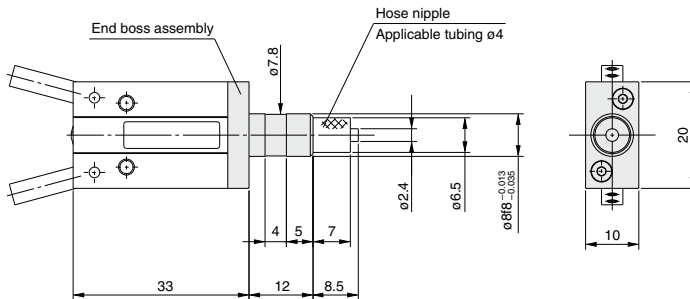

\* The specifications and dimensions not given above are identical with those of the standard type.

## Applicable Tubing

Description/Model	Nylon tubing	Soft nylon tubing	Polyurethane tubing	Polyurethane coil tubing
Specifications	<b>T0425</b>	<b>TS0425</b>	<b>TU0425</b>	<b>TCU0425B-1</b>
Outside diameter mm	4	4	4	4
Max. operating pressure MPa	1.0	0.8	0.5	0.5
Min. bending radius mm	13	12	10	—
Operating temperature °C	-20 to 60	-20 to 60	-20 to 60	-20 to 60
Material	Nylon 12	Nylon 12	Polyurethane	Polyurethane

Refer to "Best Pneumatics No. 7" regarding One-touch fittings and tubing.

# MHC2-6/MHCA2-6 Series

## Axial Ported (With One-touch fitting) [K]

### MHCA2-6SK

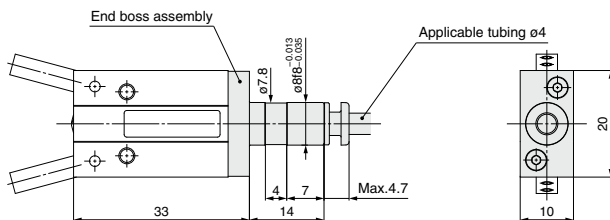

\* The specifications and dimensions not given above are identical with those of the standard type.

### Applicable Tubing

Description/Model	Nylon tubing	Soft nylon tubing	Polyurethane tubing	Polyurethane coil tubing
Specifications	T0425	TS0425	TU0425	TCU0425B-1
Outside diameter mm	4	4	4	4
Max. operating pressure MPa	1.0	0.8	0.5	0.5
Min. bending radius mm	13	12	10	—
Operating temperature °C	-20 to 60	-20 to 60	-20 to 60	-20 to 60
Material	Nylon12	Nylon12	Polyurethane	Polyurethane

Refer to "Pneumatics Piping Equipment (CAT.E50)" regarding One-touch fittings and tubing.

## Axial Ported (With M3 port) [M]

### MHCA2-6SM

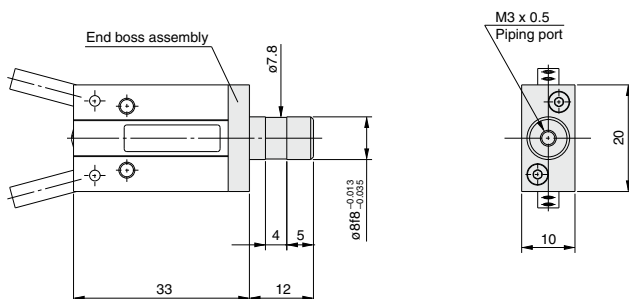

\* The specifications and dimensions not given above are identical with those of the standard type.

### Weight

Unit: g

Model	End boss type (Symbol)			
	E	H	K	M
MHCA2-6□□	23	23	23	23

# MHC2-6/MHCA2-6 Series

## Auto Switch Installation Examples and Mounting Positions

Various auto switch applications are possible through different combinations of auto switch quantities and detecting positions.

### 1) Detection when Gripping Exterior of Workpiece

Detection example		1. Confirmation of fingers in reset position	2. Confirmation of workpiece held	3. Confirmation of workpiece released
Position to be detected	Position of fingers fully opened		Position when gripping workpiece	Position of fingers fully closed
Operation of auto switch	Auto switch turned on when fingers return. (Light ON)		Auto switch turned on when gripping a workpiece. (Light ON)	When a workpiece is not held (Abnormal operation): Auto switch to turn ON (Light ON)
Detection combinations	One auto switch + One position, any of ①, ② and ③ can be detected.	●	●	●
	Two auto switches + Two positions of ①, ② and ③ can be detected.	A	●	—
		B	—	●
C	●	—	●	
How to determine auto switch installation position	Step 1) Fully open the fingers.		Step 1) Position fingers for gripping a workpiece.	Step 1) Fully close the fingers.
At no pressure or low pressure, connect the auto switch to a power supply, and follow the directions.	Step 2) Insert the auto switch into the auto switch installation groove in the direction shown in the drawing.			
	Step 3) Slide the auto switch in the direction of the arrow until the indicator light illuminates.	Step 3) Slide the auto switch in the direction of the arrow until the light illuminates and fasten it at a position 0.3 to 0.5 mm in the direction of the arrow beyond the position where the indicator light illuminates.		
	Step 4) Slide the auto switch further in the direction of the arrow until the indicator light goes out.	<p>Position where light turns ON</p>		
	Step 5) Move the auto switch in the opposite direction and fasten it at a position 0.3 to 0.5 mm beyond the position where the indicator light illuminates.	<p>Position to be secured</p>		
	Position where light turns ON	<p>Fitting position</p>		

Note 1) It is recommended to grip a workpiece when the fingers are in parallel with each other.

Note 2) When holding a workpiece close at the end of open/close stroke of fingers, detecting performance of the combinations listed in the above table may be limited, depending on the hysteresis of an auto switch, etc.

- MHZ
- MHF
- MHL
- MHR
- MHK
- MHS
- MHC
- MHT
- MHY
- MHW
- X□
- MRHQ
- MA
- D-□

# MHC2-6/MHCA2-6 Series

## Auto Switch Hysteresis

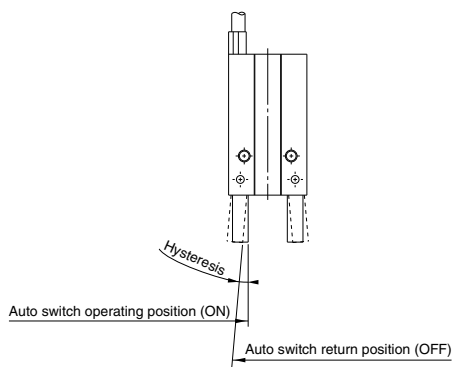

### Hysteresis

Model	D-M9□(V), M9□A(V)
MHC2-6□	4°

## Auto Switch Mounting

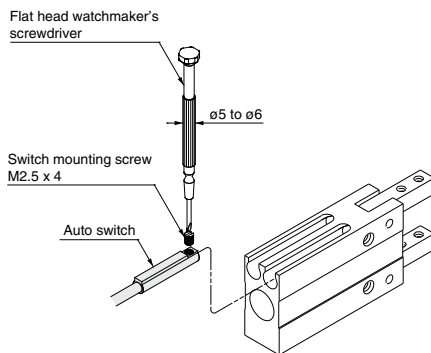

Note) Use a watchmaker's screwdriver with a grip diameter of 5 to 6 mm to tighten the auto switch mounting screw. Also, tighten with a torque of about 0.05 to 0.15 N·m, or about 0.05 to 0.10 N·m for D-M9□A(V).

## Protrusion of Auto Switch from Edge of Body

- The amount of auto switch protrusion from the body end surface is shown in the table below.
- Use this as a standard when mounting, etc.

Lead wire type	In-line entry		Perpendicular entry		
	D-M9□ M9□W	D-M9□A	D-M9□V M9□WV	D-M9□AV	
Illustration Auto switch model Finger position Air gripper model					
MHC2-6□	Open Close	6.5 mm 9 mm	8.5 mm 11 mm	4.5 mm 7 mm	6.5 mm 9 mm



# Angular Type Air Gripper/Compact Type MHCM2-7S Series

ø7

## How to Order

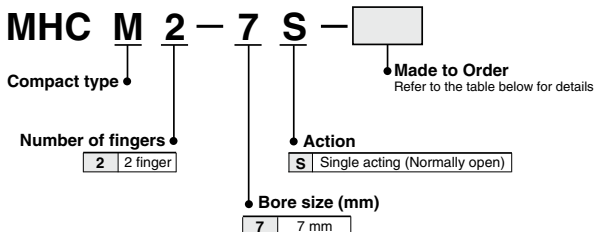

### Symbol

Single acting/ Normally open: External grip

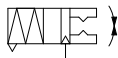

## Specifications

Fluid	Air
Operating pressure	0.4 to 0.6 MPa
Ambient and fluid temperature	-10 to 60°C
Repeatability	±0.02 mm
Maximum operating frequency	180 c.p.m.
Lubrication	Non-lube
Action	Single acting (Normally open)

## Model

Action	Model	Cylinder bore (mm)	Gripping moment <sup>(Note)</sup> (Effective value) N·m	Opening/Closing angle (Both sides)	Weight (g)
Single acting (Normally open)	MHCM2-7S	7	0.017	20° to -7°	9.5

Note) At the pressure of 0.5 MPa



**Made to Order**  
[Click here for details](#)

Symbol	Specifications/Description
-X4	Heat resistance (100°C)
-X5	Fluororubber seal
-X56	Axial piping type
-X63	Fluorine grease
-X79	Grease for food processing machines, Fluorine grease
-X79A	Grease for food processing machines
-X81A	Anti-corrosive treatment of finger

### Moisture Control Tube IDK Series



When operating an actuator with a small diameter and a short stroke at a high frequency, the dew condensation (water droplet) may occur inside the piping depending on the conditions.

Simply connecting the moisture control tube to the actuator will prevent dew condensation from occurring. For details, refer to [the IDK series in the Best Pneumatics No.6](#).

MHZ

MHF

MHL

MHR

MHK

MHS

MHC

MHT

MHY

MHW

-X□

MRHQ

MA

D-□

# MHCM2-7S Series

## Construction/MHCM2-7S (Compact type)

Single acting/With fingers open

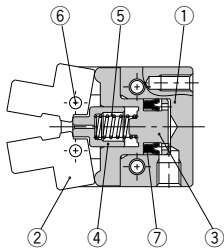

With fingers closed

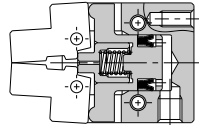

### Component Parts

No.	Description	Material	Note	Replacement parts order no.
1	Body	Aluminium alloy	Hard anodized	
2	Finger	Stainless steel	Heat treatment	
3	Piston	Stainless steel	Heat treatment	
4	Pusher	Stainless steel		
5	Spring	Piano wire	Zinc chromated	
6	Needle roller	High carbon chromium bearing steel		
7	Piston seal	NBR		MYN-4

## Dimensions

### MHCM2-7S

