

# Compact Direct Operated 2 Port Solenoid Valve

## VDW Series



Air



Medium vacuum



Water



**Lightweight**

**80g** ← **100g**

Aluminum/Resin (PPS) body (VDW2)

Current Brass body (VDW2)

**Compact**

15 mm



42.5 mm

Current model

17 mm

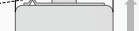

48 mm

(Compared with VDW1, Brass/Stainless steel body)

**Environmental performance** **IP65**

**Power consumption** **2.5w** **3w**

(VDW1)

(VDW2)

Body material

**Aluminum • Resin(PPS)**



Air



Water

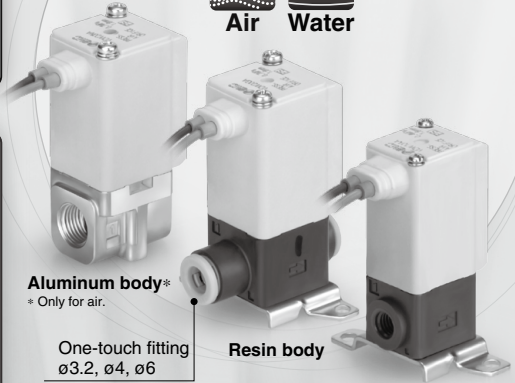

Aluminum body\*  
\* Only for air.

One-touch fitting  
ø3.2, ø4, ø6

Resin body

Body material

**Brass • Stainless Steel**



Medium vacuum



Water

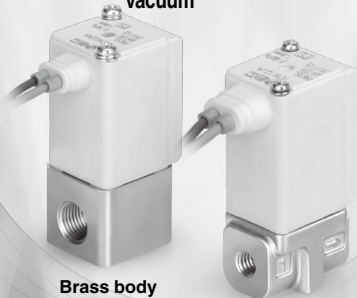

Brass body

Stainless steel body

VCH □

VDW

SX10

VQ

LVM

# Compact Direct Operated 2 Port Solenoid Valve *VDW Series*

**Air** **Medium vacuum** **Water**

**Enclosure IP65**

**Flame resistance UL94V-0 conformed**  
Flame resistant mold coil material

**Improved armature durability**

**Low-noise construction**  
Metal noise reduced by the rubber damper

**Piping variations**  
Screw piping, One-touch fitting

**Power consumption**  
2.5w (VDW1)  
3w (VDW2)

**Seal material**  
NBR (Air, Water)  
FKM (Medium vacuum)

**Body material**  
Air Aluminum  
Air · Water Resin(PPS)  
Water · Medium vacuum Brass, Stainless steel

IN (1) OUT (2)

Body material	Fluid			Size	Orifice diameter				Port size					Other special options	
	Air	Medium vacuum	Water		1	1.6	2.3	3.2	M5	1/8	ø3.2	ø4	ø6		
Aluminum	● (NBR)			Size 2 (VDW2)	—	●	●	●	●	●					· Special voltage 48 VAC 220 VAC 240 VAC 24 VAC 12 VDC · G thread, NPT thread · Oil-free <sup>Note 1)</sup> · Low concentration ozone resistant, Deionized water (Seal material: FKM) <sup>Note 2)</sup> · With bracket
Resin(PPS)	● (NBR)		● (NBR)	Size 1 (VDW1)	●	●	—	—	●		●	●			
				Size 2 (VDW2)	—	●	●	●				●	●		
Brass/ Stainless steel				Size 1 (VDW1)	●	●	—	—	●						
				Size 2 (VDW2)	—	●	●	●	●	●					

The materials in ( ) are the seal materials.

Note 1) As standard for medium vacuum type.  
Note 2) For air, water.

# Compact Direct Operated 2 Port Solenoid Valve

## VDW Series

For Air · Medium Vacuum · Water

### Standard Specifications

Valve specifications	Valve construction		Direct operated poppet
	Withstand pressure	MPa	2.0 (resin body type 1.5)
	Max. system pressure <small>Note 3)</small>	MPa	1.0
	Body material		Aluminum, Resin, Brass, Stainless steel
	Seal material		NBR, FKM
Enclosure		Dusttight, Low jetproof (IP65) <small>Note 2)</small>	
Environment		Location without corrosive or explosive gases	
Coil specifications	Rated voltage	AC	100 VAC, 200 VAC, 110 VAC, 230 VAC, (220 VAC, 240 VAC, 48 VAC, 24 VAC) <small>Note 1)</small>
		DC	24 VDC, (12 VDC) <small>Note 1)</small>
	Allowable voltage fluctuation		±10% of rated voltage
	Allowable leakage voltage	AC (With a full wave rectifier)	5% or less of rated voltage
		DC	2% or less of rated voltage
Coil insulation type		Class B	

⚠ Be sure to read "Specific Product Precautions" before handling.

Note 1) Voltage in ( ) indicates special voltage. (Refer to page 462.)

Note 2) For enclosure, refer to "Glossary of Terms" on page 466.

When using the product in a place which requires water resistance, please contact SMC.

Note 3) Refer to "Glossary of Terms" on page 466 for details on the maximum system pressure.

### Solenoid Coil Specifications

#### Normally Closed (N.C.)

##### DC Specification

Size	Power consumption (W) <small>Note 1)</small>	Temperature rise (°C) <small>Note 2)</small>
Size 1	2.5	60
Size 2	3	60

Note 1) Power consumption, Apparent power: The value at ambient temperature of 20°C and when the rated voltage is applied. (Variation: ±10%)

Note 2) The value at ambient temperature of 20°C and when the rated voltage is applied. The value depends on the ambient environment. This is for reference.

##### AC Specification (With a full wave rectifier)

Size	Apparent power (VA) <small>Note 1) 2)</small>	Temperature rise (°C) <small>Note 3)</small>
Size 1	2.5	60
Size 2	3	60

Note 1) Power consumption, Apparent power: The value at ambient temperature of 20°C and when the rated voltage is applied. (Variation: ±10%)

Note 2) There is no difference in the frequency and the inrush and energized apparent power, since a rectifying circuit is used in the AC (with a full wave rectifier).

Note 3) The value at ambient temperature of 20°C and when the rated voltage is applied. The value depends on the ambient environment. This is for reference.

### Selection Steps

**Step 1** Select the fluid.

Item	Selection item	Page	Symbol
Select the fluid.	Air	Page 456	0
	Water	Page 460	2
	Medium vacuum	Page 458	4

VDW <sup>1</sup>/<sub>2</sub> 0 A A

**Step 2** Select "Body material", "Port size" and "Orifice diameter" from "Flow rate — Pressure" of each fluid.

Item	Selection item	Symbol
Select from "Flow rate — Pressure." • Body material • Port size • Orifice diameter	Size Size 1	1
	Body material Resin	A
	Port size M5	A
	Orifice diameter 1	1

VDW 1 0 A A

**Step 3** Select electric specifications.

Item	Selection item	Symbol
Select electric specifications.	Voltage 24 VDC	A
	Electrical entry Grommet	A

VDW 1 0 A A

**Step 4** For other special options, refer to page 462.

VCH □

VDW

SX10

VQ

LVM



## For Air Single Unit

### Model/Valve Specifications

N.C.

#### Symbol

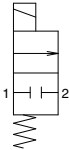

Note) The symbol shows ports 1 and 2 as blocked, but there is actually a limit to the blocking capability when the pressure of port 2 is greater than the pressure of port 1. Please contact SMC when low leakage performance is required.

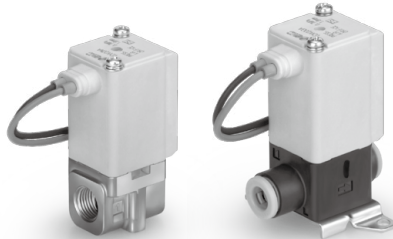

#### Normally Closed (N.C.)

##### Aluminum Body Type

\* Flow rate characteristics show those when the port size is 1/8 (size 2).

Size	Port size	Orifice diameter (mm)	Model	Flow rate characteristics <sup>Note 1)</sup>			Maximum operating <sup>Note 2)</sup> pressure differential (MPa)	Weight (g)
				C [dm <sup>3</sup> /(s·bar)]	b	Cv	Pressurized port 1	
2	M5, 1/8	1.6	VDW20	0.30	0.45	0.07	0.7	80
		2.3		0.58	0.45	0.18	0.4	
		3.2		1.10	0.38	0.30	0.2	

##### Resin Body Type (Built-in One-touch Fittings)

\* Flow rate characteristics show those when the One-touch fitting with a port size of ø4 (size 1 or 2) is used.

Size	Port size	Orifice diameter (mm)	Model	Flow rate characteristics <sup>Note 1)</sup>			Maximum operating <sup>Note 2)</sup> pressure differential (MPa)	Weight (g)
				C [dm <sup>3</sup> /(s·bar)]	b	Cv	Pressurized port 1	
1	M5	1.0	VDW10	0.14	0.40	0.04	0.9	45
	ø3.2 One-touch fitting ø4 One-touch fitting	1.6		0.30	0.25	0.07	0.4	
2	M5 ø4 One-touch fitting ø6 One-touch fitting	1.6	VDW20	0.30	0.45	0.07	0.7	80
		2.3		0.42	0.45	0.12	0.4	
		3.2		0.56	0.40	0.16	0.2	

Note 1) The flow rate characteristics of this product have variations.

When the highly precise flow control is required according to the system to be used, select an orifice diameter 1.3 times larger than that shown above and install a restrictor on the downstream side of the solenoid valve to make the adjustment.

Note 2) Refer to "Glossary of Terms" on page 466 for details on the maximum operating pressure differential.

### Fluid and Ambient Temperature

Fluid temperature (°C)	Ambient temperature (°C)
-10 <sup>Note)</sup> to 50	-10 to 50

Note) Dew point temperature: -10°C or less

### Valve Leakage

#### Internal Leakage

Seal material	Leakage rate (Air) <sup>Note)</sup>
NBR	1 cm <sup>3</sup> /min or less (Aluminum body type) 15 cm <sup>3</sup> /min or less (Resin body type)

#### External Leakage

Seal material	Leakage rate (Air) <sup>Note)</sup>
NBR	1 cm <sup>3</sup> /min or less (Aluminum body type) 15 cm <sup>3</sup> /min or less (Resin body type)

Note) Leakage is the value at ambient temperature 20°C.

# Compact Direct Operated 2 Port Solenoid Valve **VDW Series**



**For Air Single Unit**



## How to Order (Single Unit)

**VDW 1 0 A A**

**Fluid**  
0 For air

### Common Specifications

Valve type	N.C.
Seal material	NBR
Coil insulation type	Class B
Thread type	Rc*

\* One-touch fittings are attached to the resin body type.

### Size/Valve type

Symbol	Size	Valve type
1	Size 1 (VDW1)	Single unit N.C.

### Body material/Port size/Orifice diameter

Symbol	Body material	Port size	Orifice diameter
A	Resin (PPS) With bracket	M5	1.0
B			1.6
C		ø3.2 One-touch fitting	1.0
D			1.6
E		ø4 One-touch fitting	1.0
F			1.6

### Voltage/Electrical entry

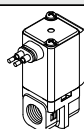
Symbol	Voltage	Electrical entry
A	24 VDC	Grommet 
B	100 VAC	
C	110 VAC	
D	200 VAC	
E	230 VAC	
Z	Other voltages	

Symbol	Body material	Port size	Orifice diameter	
A	Resin (PPS) With bracket	M5	1.6	
B			2.3	
C		ø4 One-touch fitting	3.2	
D			1.6	
E		ø6 One-touch fitting	2.3	
F			3.2	
G		Aluminum	M5	1.6
H				2.3
J	ø4 One-touch fitting		3.2	
K			1.6	
L	1/8		2.3	
M			3.2	
N	1/8	1.6		
P		2.3		
Q	3.2			

For other special options, refer to page 462.

Special voltage	
	48 VAC
	220 VAC
	240 VAC
	24 VAC
	12 VDC
Low concentration ozone resistant (Seal material: FKM)	
Oil-free	
G thread	
NPT thread	
With bracket (Aluminum body only)	

Dimensions→Page 463 (Single unit)

VCH

VDW

SX10

VQ

LVM



## For Medium Vacuum Single Unit

\* This valve can also be used with air.  
(Refer to the valve specifications on page 456 for air.)

### Model/Valve Specifications

N.C.

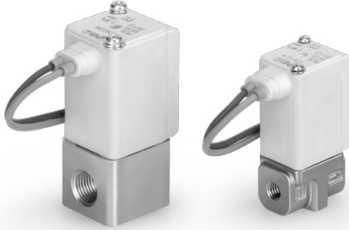

#### Symbol (Application example)

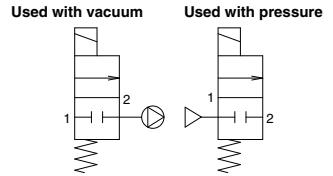

Note) The symbol shows ports 1 and 2 as blocked, but there is actually a limit to the blocking capability when the pressure of port 2 is greater than the pressure of port 1. Please contact SMC when low leakage performance is required.

#### Normally Closed (N.C.)

\* Flow rate characteristics show those when the port size is M5 (size 1) or 1/8 (size 2).

Size	Port size	Orifice diameter (mm)	Model	Flow rate characteristics <sup>Note 1)</sup>			Maximum operating pressure differential (MPa) <sup>Note 2)</sup>	Weight (g)
				C [dm <sup>3</sup> /(s·bar)]	b	Cv		
1	M5	1.0	VDW14	0.14	0.40	0.04	0.9	Brass: 65 Stainless steel: 60
		1.6		0.30	0.25	0.07		
2	M5, 1/8	1.6	VDW24	0.30	0.45	0.07	0.7	Brass: 115 Stainless steel: 100
		2.3		0.58	0.45	0.18		
		3.2		1.10	0.38	0.30		

Note 1) The flow rate characteristics of this product have variations.

When the highly precise flow control is required according to the system to be used, select an orifice diameter 1.3 times larger than that shown above and install a restrictor on the downstream side of the solenoid valve to make the adjustment.

Note 2) Refer to "Glossary of Terms" on page 466 for details on the maximum operating pressure differential.

### Fluid and Ambient Temperature

Fluid temperature (°C)	Ambient temperature (°C)
1 to 50	-10 to 50

Note) With no freezing

### Valve Leakage

#### Internal Leakage

Seal material	Leakage rate <sup>Note)</sup>
FKM	10 <sup>-6</sup> Pa·m <sup>3</sup> /sec or less

#### External Leakage

Seal material	Leakage rate <sup>Note)</sup>
FKM	10 <sup>-6</sup> Pa·m <sup>3</sup> /sec or less

Note) Leakage (10<sup>-6</sup> Pa·m<sup>3</sup>/sec) is the value at 0.1 Pa-abs and ambient temperature 20°C.

# Compact Direct Operated 2 Port Solenoid Valve **VDW Series**

**For Medium Vacuum Single Unit**



## How to Order (Single Unit)

**VDW 1 4 A A**

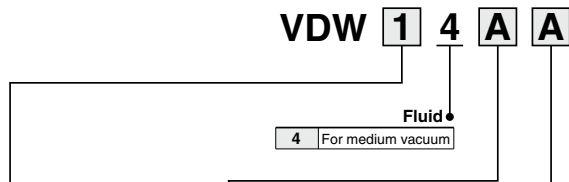

### Common Specifications

Valve type	N.C.
Seal material	FKM
Coil insulation type	Class B
Thread type	Rc
Oil-free	

### Size/Valve type

Symbol	Size	Valve type
<b>1</b>	Size 1 (VDW1)	Single unit N.C.

### Body material/Port size/Orifice diameter

Symbol	Body material	Port size	Orifice diameter
<b>G</b>	Brass	M5	1.0
<b>H</b>			1.6
<b>J</b>	Stainless steel	M5	1.0
<b>K</b>			1.6

### Voltage/Electrical entry

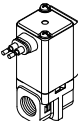
Symbol	Voltage	Electrical entry
<b>A</b>	24 VDC	Grommet 
<b>B</b>	100 VAC	
<b>C</b>	110 VAC	
<b>D</b>	200 VAC	
<b>E</b>	230 VAC	
<b>Z</b>	Other voltages	

Symbol	Size	Valve type
<b>2</b>	Size 2 (VDW2)	Single unit N.C.

Symbol	Body material	Port size	Orifice diameter
<b>K</b>	Brass	M5	1.6
<b>L</b>			2.3
<b>M</b>			3.2
<b>N</b>			1.6
<b>P</b>	Stainless steel	1/8	2.3
<b>Q</b>			3.2
<b>R</b>			1.6
<b>S</b>			2.3
<b>T</b>	Stainless steel	M5	3.2
<b>U</b>			1.6
<b>V</b>			2.3
<b>W</b>			3.2

For other special options, refer to page 462.

Special voltage	
	48 VAC
	220 VAC
	240 VAC
	24 VAC
	12 VDC
G thread	
NPT thread	
With bracket	

Dimensions→Page 463 (Single unit)

VCH

VDW

SX10

VQ

LVM



## For Water Single Unit

\* This valve can also be used with air.  
(Refer to the valve specifications on page 456 for air.)

### Model/Valve Specifications

N.C.

#### Symbol

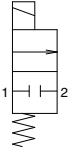

Note) The symbol shows ports 1 and 2 as blocked, but there is actually a limit to the blocking capability when the pressure of port 2 is greater than the pressure of port 1. Please contact SMC when low leakage performance is required.

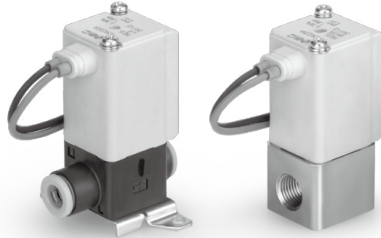

#### Normally Closed (N.C.)

##### C37, Stainless Steel Body Type

\* Flow rate characteristics show those when the port size is M5 (size 1) or 1/8 (size 2).

Size	Port size	Orifice diameter (mmø)	Model	Flow rate characteristics <sup>Note 1)</sup>		Maximum operating <sup>Note 2)</sup> pressure differential (MPa)	Weight (g)
				Kv	Conversion Cv	Pressurized port 1	
1	M5	1.0	VDW12	0.034	0.04	0.9	Brass: 65 Stainless steel: 60
		1.6		0.06	0.07	0.4	
2	M5, 1/8	1.6	VDW22	0.06	0.07	0.7	Brass: 115 Stainless steel: 100
		2.3		0.15	0.18	0.4	
		3.2	0.26	0.30	0.2		

##### Resin Body Type

\* Flow rate characteristics show those when the One-touch fitting with a port size of ø4 (size 1 or 2) is used.

Size	Port size	Orifice diameter (mmø)	Model	Flow rate characteristics <sup>Note 1)</sup>		Maximum operating <sup>Note 2)</sup> pressure differential (MPa)	Weight (g)
				Kv	Conversion Cv	Pressurized port 1	
1	M5 ø3.2 One-touch fitting ø4 One-touch fitting	1.0	VDW12	0.034	0.04	0.9	45
		1.6		0.06	0.07	0.4	
2	M5 ø4 One-touch fitting ø6 One-touch fitting	1.6	VDW22	0.06	0.07	0.7	80
		2.3		0.10	0.12	0.4	
		3.2	0.14	0.16	0.2		

Note 1) The flow rate characteristics of this product have variations.

When the highly precise flow control is required according to the system to be used, select an orifice diameter 1.3 times larger than that shown above and install a restrictor on the downstream side of the solenoid valve to make the adjustment.

Note 2) Refer to "Glossary of Terms" on page 466 for details on the maximum operating pressure differential.

### Fluid and Ambient Temperature

Fluid temperature (°C)	Ambient temperature (°C)
1 to 50	-10 to 50

Note) With no freezing

### Valve Leakage

**Internal Leakage** <sup>Note 1)</sup> Internal leakage when pressure is supplied to Port 1 (IN).

Seal material	Leakage rate (Water) <sup>Note 2)</sup>
NBR	0.1 cm <sup>3</sup> /min or less (C37, Stainless steel body type)
	1 cm <sup>3</sup> /min or less (Resin body type)

#### External Leakage

Seal material	Leakage rate (Water) <sup>Note 2)</sup>
NBR	0.1 cm <sup>3</sup> /min or less (C37, Stainless steel body type)
	1 cm <sup>3</sup> /min or less (Resin body type)

Note 2) Leakage is the value at ambient temperature 20°C.



# Compact Direct Operated 2 Port Solenoid Valve **VDW Series**

 **For Water Single Unit**



## How to Order (Single Unit)

**VDW 1 2 A A**

**Fluid**  
2 For water

### Common Specifications

Valve type	N.C.
Seal material	NBR
Coil insulation type	Class B
Thread type	Rc

\* One-touch fittings are attached to the resin body type.

### Size/Valve type

Symbol	Size	Valve type
1	Size 1 (VDW1)	Single unit N.C.

### Body material/Port size/Orifice diameter

Symbol	Body material	Port size	Orifice diameter
A	Resin (PPS) (With bracket)	M5	1.0
B			1.6
C		ø3.2 One-touch fitting	1.0
D			1.6
E		ø4 One-touch fitting	1.0
F			1.6
G	Brass	M5	1.0
H			1.6
J	Stainless steel	M5	1.0
K			1.6

### Voltage/Electrical entry

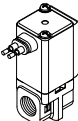
Symbol	Voltage	Electrical entry
A	24 VDC	Grommet 
B	100 VAC	
C	110 VAC	
D	200 VAC	
E	230 VAC	
Z	Other voltages	

Symbol	Size	Valve type
2	Size 2 (VDW2)	Single unit N.C.

Symbol	Body material	Port size	Orifice diameter
A	Resin (PPS) (With bracket)	M5	1.6
B			2.3
C		ø4 One-touch fitting	3.2
D			1.6
E		ø6 One-touch fitting	2.3
F			3.2
G	Brass	M5	1.6
H			2.3
J	Stainless steel	1/8	3.2
K			1.6
L	Brass	M5	2.3
M			3.2
N	Stainless steel	1/8	1.6
P			2.3
Q	Brass	M5	3.2
R			1.6
S	Stainless steel	1/8	2.3
T			3.2
U	Brass	M5	1.6
V			2.3
W	Stainless steel	1/8	3.2
X			1.6

For other special options, refer to page 462.

Special voltage	Voltage
	48 VAC
	220 VAC
	240 VAC
	24 VAC
	12 VDC
Deionized water (Seal material: FKM)	
Oil-free	
G thread	
NPT thread	
Bracket interchangeable with old type	
With bracket (Brass, Stainless steel body only)	

Dimensions → Page 463 (Single unit)

VCH

**VDW**

**SX10**

**VQ**

**LVM**

# VDW Series

## Other Special Options

### Electrical options (Special voltage)

VDW 1 0 A Z 1A

Enter standard product number.

Electrical option

#### Electrical option (Special voltage)

Special voltage	Symbol	Voltage	Electrical entry
Special voltage	1A	48 VAC	Grommet
	1B	220 VAC	
	1C	240 VAC	
	1U	24 VAC	
	1D	12 VDC	

### Other options

(Low concentration ozone resistant, Deionized water, oil-free, special thread)

VDW 1 0 A A Z

Enter standard product number.

Other option (Low concentration ozone resistant, Deionized water, oil-free, special thread)

Symbol	Low concentration ozone <sup>*1, *4</sup> resistant, Deionized water (Seal material: FKM)	Oil-free <sup>*1</sup>	Special <sup>*2, *3</sup> thread
Nil	—	—	— (Standard)
A	—	—	G1/8 <sup>*5</sup>
B	—	—	NPT1/8
C	—	—	M6
Z	—	—	— (Standard)
D	—	—	G1/8 <sup>*5</sup>
E	—	○	NPT1/8
F	—	—	M6
G	—	—	— (Standard)
H	○	—	G1/8 <sup>*5</sup>
J	—	—	NPT1/8
K	—	—	M6
L	—	—	— (Standard)
M	○	○	G1/8 <sup>*5</sup>
N	—	—	NPT1/8
P	—	—	M6

\*1 Applicable for air type (VDW□□) and water type (VDW□2).

\*2 When G or NPT is selected, choose the 1/8 port size standard model.

\*3 When M6 is selected, choose the M5 port size standard model.

\*4 When using deionized water or any other fluid that may corrode C37 (brass), select a stainless steel body.

\*5 For connection, prepare a fitting compliant with ISO 16030 and JIS B 8674.

### Special electrical entry direction

VDW         XC A

Enter standard product number.

#### Special electrical entry direction

Symbol	Electrical entry direction	
	VDW1	VDW2
A	Not possible	
B		
C	Not possible	

### With bracket/Special electrical entry direction

VDW         XD A

Enter standard product number.

#### With bracket (Shipped together)/Special electrical entry direction

Symbol	Electrical entry direction	
	VDW1	VDW2
A	Not possible	
B		
C	Not possible	

### Bracket interchangeable with old type

The brackets are interchangeable with brackets of old VDW10/20 series. For details of exterior dimensions, please contact SMC.

VDW         XB

Enter standard product number.

Bracket interchangeable with old type (Shipped together)

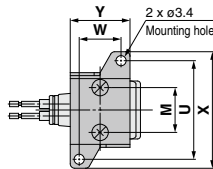

Size	M	U	W	X	Y
VDW1	11	28	11	34	17
VDW2	15	33	14	39	20

\* Bracket part no.  
Size 1: VDW10S-12A-1  
Size 2: VDW20S-12A-1

\* Enter symbols in the order to the right when ordering a combination of electrical option, other options, and bracket interchangeable with old type.

Example VDW 2 0 A Z 1A Z XB

Electrical option  
Other option  
Bracket interchangeable with old type

## Construction

### Normally closed (N.C.)

Body material: Aluminum, PPS resin, Brass, Stainless steel

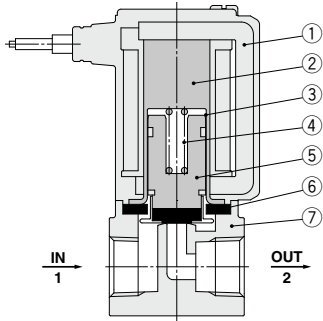

### Component Parts

No.	Description	Material
1	Solenoid coil	Cu + Fe + Resin
2	Fixed armature	Fe
3	Tube	Stainless steel
4	Return spring	Stainless steel
5	Armature assembly	NBR, FKM, Stainless steel, PPS resin
6	Seal	NBR, FKM
7	Body	Aluminum, PPS resin, Brass, Stainless steel

### Body material: PPS resin (One-touch fitting type)

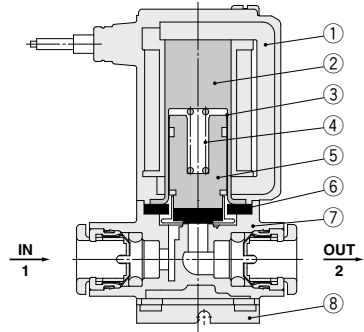

### Component Parts

No.	Description	Material
1	Solenoid coil	Cu + Fe + Resin
2	Fixed armature	Fe
3	Tube	Stainless steel
4	Return spring	Stainless steel
5	Armature assembly	NBR, FKM, Stainless steel, PPS resin
6	Seal	NBR, FKM
7	Body	PPS resin
8	Bracket	SPCC

VCH □

VDW

SX10

VQ

LVM



# Compact Direct Operated 2 Port Solenoid Valve **VDW Series**



## Dimensions/Single Unit

**Body material** Aluminum

Grommet

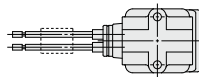
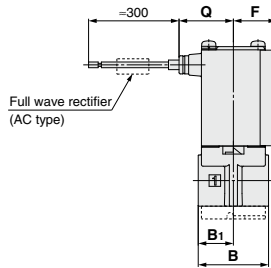
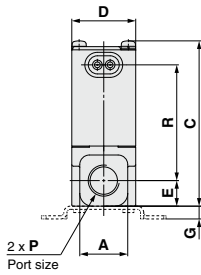
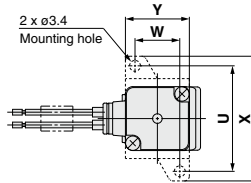

- VCH
- VDW**
- SX10
- VQ
- LVM

Model	Port size P	A	B	B <sub>1</sub>	C	D	E	F	Mounting bracket dimensions (XD)					Electrical entry	
									G	U	W	X	Y	Grommet	
														Q	R
<b>VDW2</b>	M5, 1/8	15	22	11	51.7	20	8	13.5	4	33	14	39	20	17	36.2

**Made to Order**

<Special lead wire length>

Produced upon receipt of order. Please contact SMC for lead times.

**VDW**     **XL**

◆ Lead wire length

<b>XL1</b>	600 mm
<b>XL2</b>	1000 mm
<b>XL3</b>	1500 mm
<b>XL4</b>	3000 mm

# VDW Series



Air, Medium Vacuum, Water

## Dimensions/Single Unit

### Body material Resin

With One-touch fittings  
Grommet

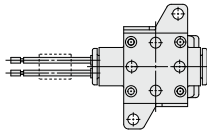
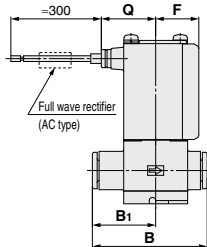
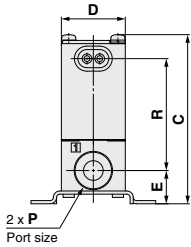
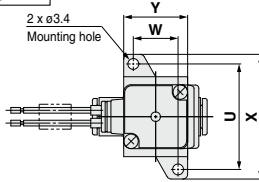

For information on handling One-touch fittings and on appropriate tubing, refer to page 469 and the Fittings & Tubing section of the "Handling Precautions for SMC Products" on the SMC website.

[mm]							
Model	One-touch fitting P	B	B <sub>1</sub>	C	D	E	F
VDW1	ø3.2, ø4	31.7	17.1	46.1	15	9.5	11
VDW2	ø4, ø6	35.9	19.8	52.9	20	10.4	13.5

Model	One-touch fitting P	Mounting bracket dimensions				Electrical entry Grommet	
		U	W	X	Y	Q	R
VDW1	ø3.2, ø4	28	11	34	17	15.5	30.35
VDW2	ø4, ø6	33	14	39	20	17	35

Port size M5/M6  
Grommet

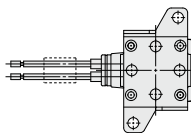
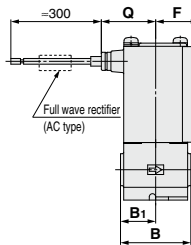
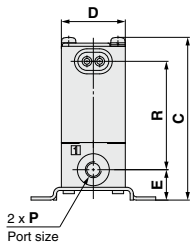
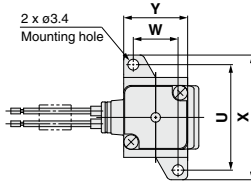

[mm]							
Model	Port size P	B	B <sub>1</sub>	C	D	E	F
VDW1	M5(M6)	20	10	46.1	15	9.5	11
VDW2	M5(M6)	22	11	50.9	20	9.5	13.5

Model	Port size P	Mounting bracket dimensions				Electrical entry Grommet	
		U	W	X	Y	Q	R
VDW1	M5(M6)	28	11	34	17	15.5	30.35
VDW2	M5(M6)	33	14	39	20	17	33.9

# Compact Direct Operated 2 Port Solenoid Valve **VDW Series**



## Dimensions/Single Unit

### Body material **Brass**

Grommet

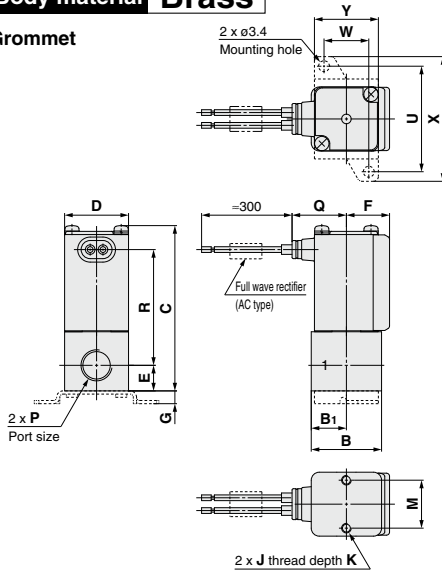

Model	Port size P	B	B <sub>1</sub>	C	D	E	F	Mounting method		
								J	K	M
VDW1	M5	20	10	42.4	15	6	11	M2.5	4	11
VDW2	M5, 1/8	22	11	51.7	20	8	13.5	M3	5	15

Model	Port size P	Mounting bracket dimensions (XD)					Electrical entry Grommet	
		G	U	W	X	Y	Q	R
VDW1	M5	4	28	11	34	17	15.5	30.15
VDW2	M5, 1/8	4	33	14	39	20	17	36.2

### Body material **Stainless Steel**

Grommet

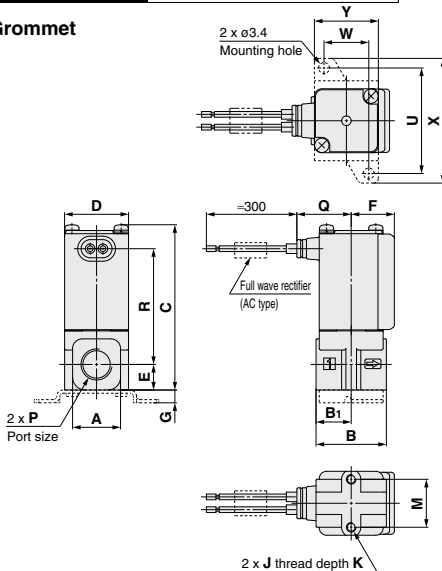

Model	Port size P	A	B	B <sub>1</sub>	C	D	E	F	Mounting method		
									J	K	M
VDW1	M5	12	20	10	42.4	15	6	11	M2.5	4	11
VDW2	M5, 1/8	15	22	11	51.7	20	8	13.5	M3	5	15

Model	Port size P	Mounting bracket dimensions (XD)					Electrical entry Grommet	
		G	U	W	X	Y	Q	R
VDW1	M5	4	28	11	34	17	15.5	30.15
VDW2	M5, 1/8	4	33	14	39	20	17	36.2

VCH □

VDW

SX10

VQ

LVM

# VDW Series

## Glossary of Terms

### Pressure Terminology

#### 1. Maximum operating pressure differential

The maximum pressure differential (the difference between the inlet and outlet pressure) which is allowed for operation. When the outlet pressure is 0 MPa, this becomes the maximum operating pressure.

#### 2. Maximum system pressure

The maximum pressure that can be applied inside the pipelines (line pressure).

[The pressure differential in the solenoid valve portion must be less than the maximum operating pressure differential.]

#### 3. Withstand pressure

The pressure in which the valve must be withstood without a drop in performance after holding for one minute under prescribed (static) pressure and returning to the operating pressure range. [value under the prescribed conditions]

### Electrical Terminology

#### 1. Surge voltage

A high voltage which is momentarily generated by shutting off the power in the shut-off area.

#### 2. Enclosure

A degree of protection defined in the "JIS C 0920: Waterproof test of electric machinery/appliance and the degree of protection against the intrusion of solid foreign objects".

Verify the degree of protection for each product.

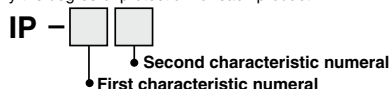

#### ● First Characteristics: Degrees of protection against solid foreign objects

0	Non-protected
1	Protected against solid foreign objects of ø50 mm and greater
2	Protected against solid foreign objects of ø12 mm and greater
3	Protected against solid foreign objects of ø2.5 mm and greater
4	Protected against solid foreign objects of ø1.0 mm and greater
5	Dust-protected
6	Dusttight

#### ● Second Characteristics: Degrees of protection against water

0	Non-protected	—
1	Protected against vertically falling water drops	Dripproof type 1
2	Protected against vertically falling water drops when enclosure tilted up to 15°	Dripproof type 2
3	Protected against rainfall when enclosure tilted up to 60°	Rainproof type
4	Protected against splashing water	Splashproof type
5	Protected against water jets	Low jetproof type
6	Protected against powerful water jets	Strong jetproof type
7	Protected against the effects of temporary immersion in water	Immersible type
8	Protected against the effects of continuous immersion in water	Submersible type

Example) IP65: Dusttight, Low jetproof type

"Low jetproof type" means that no water intrudes inside an equipment that could hinder from operating normally by means of applying water for 3 minutes in the prescribed manner. Take appropriate protection measures, since a device is not usable in an environment where a droplet of water is splashed constantly.

### Others

#### 1. Material

NBR: Nitrile rubber

FKM: Fluororubber

#### 2. Oil-free treatment

The degreasing and washing of wetted parts

#### 3. Symbol

Symbol (☞☞☞☞) IN and OUT are in a blocked condition (±), but actually in the case of reverse pressure (OUT> IN), there is a limit to the blocking.

Product with flow direction 2 → 1 with pressure supplied to port 2 and universal specification product are available as specials.





# VDW Series

## Specific Product Precautions 1

Be sure to read this before handling the products.

Refer to back page 50 for Safety Instructions and pages 17 to 19 for 2 Port Solenoid Valve for Fluid Control Precautions.

### Design

#### ⚠ Warning

##### 1. Cannot be used as an emergency shutoff valve, etc.

The valves presented in this catalog are not designed for safety applications such as an emergency shutoff valve. If the valves are used in this type of system, other reliable safety assurance measures should also be adopted.

##### 2. Extended periods of continuous energization

The solenoid coil will generate heat when continuously energized. Avoid using in a tightly shut container. Install it in a well-ventilated area. Furthermore, do not touch it while it is being energized or right after it is energized.

##### 3. Closed liquid circuit

In a closed circuit, when liquid is static, pressure could rise due to changes in temperature. This pressure rise could cause malfunction and damage to components such as valves. To prevent this, install a relief valve in the system.

##### 4. Actuator drive

When an actuator, such as a cylinder, is to be driven using a valve, take appropriate measures to prevent potential danger caused by actuator operation.

##### 5. Pressure (including vacuum) holding

It is not usable for an application such as holding the pressure (including vacuum) inside of a pressure vessel because air leakage is entailed in a valve.

##### 6. When an impact, such as water hammer, etc., caused by the rapid pressure fluctuation is applied, the solenoid valve may be damaged. Give an attention to it.

### Selection

#### ⚠ Warning

##### 1. Fluid

###### 1) Type of fluid

Before using a fluid, check whether it is compatible with the materials of each model by referring to the fluids listed in this catalog. Use a fluid with a kinematic viscosity of 50 mm<sup>2</sup>/s or less. If there is something you do not know, please contact SMC.

###### 2) Flammable oil, Gas

Confirm the specification for leakage in the interior and/or exterior area.

###### 3) Corrosive gas

Cannot be used since it will lead to cracks by stress corrosion or result in other incidents.

4) Depending on water quality, a brass body can cause corrosion and internal leakage may occur. If such abnormalities occur, exchange the product for a stainless steel body.

5) Use an oil-free specification when any oily particle must not enter the passage.

6) Applicable fluid on the list may not be used depending on the operating condition. Give adequate confirmation, and then determine a model, just because the compatibility list shows the general case.

### Selection

#### ⚠ Warning

##### 2. Fluid quality

###### <Air>

###### 1) Use clean air.

Do not use compressed air that contains chemicals, synthetic oils including organic solvents, salt or corrosive gases, etc., as it can cause damage or malfunction.

###### 2) Install an air filter.

Install air filters close to the valves on the upstream side. A filtration degree of 5 μm or less should be selected.

###### 3) Install an aftercooler or air dryer, etc.

Compressed air that contains excessive drainage may cause malfunction of valves and other pneumatic equipment. To prevent this, install an aftercooler or air dryer, etc.

###### 4) If excessive carbon powder is generated, eliminate it by installing mist separators at the upstream side of valves.

If excessive carbon powder is generated by the compressor, it may adhere to the inside of the valves and cause a malfunction.

Refer to Best Pneumatics No.7 for further details on compressed air quality.

###### <Vacuum>

Please be aware that there is a range of pressure that can be used.

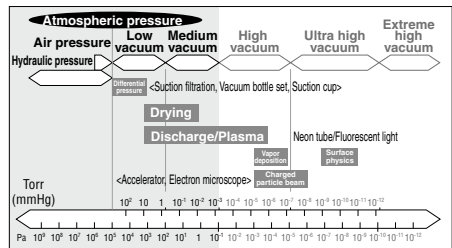

Vacuum piping direction: if the system uses a vacuum pump, we ask that you install the vacuum pump on the secondary side (Port 2).

Also, install a filter on the primary side (Port 1), and be careful that no foreign object is picked up.

Please replace the valve after operating the device approximately 300,000 times.

VCH □

VDW

SX10

VQ

LVM



## VDW Series

# Specific Product Precautions 2

Be sure to read this before handling the products.

Refer to back page 50 for Safety Instructions and pages 17 to 19 for 2 Port Solenoid Valve for Fluid Control Precautions.

### Selection

## ⚠ Warning

### <Water>

The use of a fluid that contains foreign objects can cause problems such as malfunction and seal failure by promoting wear of the valve seat and armature and by sticking to the sliding parts of the armature etc. Install a suitable filter (strainer) immediately upstream from the valve. As a general rule, use 100 mesh.

The supply water includes materials that create a hard sediment or sludge such as calcium and magnesium. Since this scale and sludge can cause the valve to malfunction, install water softening equipment, and a filter (strainer) directly upstream from the valve to remove these substances.

### Tap water pressure:

The water pressure for tap water is normally 0.4 MPa or less. However, in places like a high-rise building, the pressure may be 1.0 MPa. When selecting tap water, be careful of the maximum operating pressure differential.

When using water or heated water, poor operation or leaks may be caused by dezincification, erosion, corrosion, etc. The brass (Brass) body of this product uses dezincification resistant material as a standard. We also offer a stainless steel body type with improved corrosion resistance. Please use the one that fits your needs.

### 3. Ambient environment

Use within the operable ambient temperature range. Check the compatibility between the product's composition materials and the ambient atmosphere. Be certain that the fluid used does not touch the external surface of the product.

### 4. Countermeasures against static electricity

Take measures to prevent static electricity since some fluids can cause static electricity.

### 5. Low temperature operation

- 1) The valve can be used in an ambient temperature of between  $-10$  to  $-20^{\circ}\text{C}$ . However, take measures to prevent freezing or solidification of impurities, etc.
- 2) When using valves for water application in cold climates, take appropriate countermeasures to prevent the water from freezing in tubing after cutting the water supply from the pump, by draining the water etc. When warming by a heater etc., be careful not to expose the coil portion to a heater. Installation of a dryer, heat retaining of the body is recommended to prevent a freezing condition in which the dew point temperature is high and the ambient temperature is low, and the high flow runs.

### Selection

## ⚠ Caution

### 1. Leakage voltage

When the solenoid valve is operated using the controller, etc., the leakage voltage should be the product allowable leakage voltage or less. Particularly when using a resistor in parallel with a switching element and using a C-R element (surge voltage suppressor) to protect the switching element, take note that leakage current will flow through the resistor, C-R element, etc., creating a possible danger that the valve may not turn off.

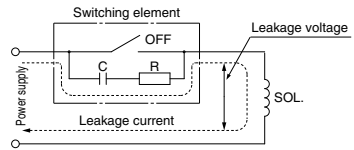

AC/Class B built-in full wave rectifier coil: 5% or less of rated voltage  
DC coil: 2% or less of rated voltage

### 2. Selecting model

Material depends on fluid. Select optimal models for the fluid.

### Mounting

## ⚠ Warning

### 1. If air leakage increases or equipment does not operate properly, stop operation.

After mounting is completed, confirm that it has been done correctly by performing a suitable function test.

### 2. Do not apply external force to the coil section.

When tightening is performed, apply a wrench or other tool to the outside of the piping connection parts.

### 3. Mount a valve with its coil position upwards, not downwards.

When mounting a valve with its coil positioned downwards, foreign objects in the fluid will adhere to the iron core leading to a malfunction. Especially for strict leakage control, such as with vacuum applications and non-leak specifications, the coil must be positioned upwards.

### 4. Do not warm the coil assembly with a heat insulator, etc.

Use tape, heaters, etc., for freeze prevention on the piping and body only. They can cause the coil to burn out.

### 5. Secure with brackets, except in the case of steel piping and copper fittings.

### 6. Avoid sources of vibration, or adjust the arm from the body to the minimum length so that resonance will not occur.

### 7. Painting and coating

Warnings or specifications printed or labeled on the product should not be erased, removed or covered up.



# VDW Series

## Specific Product Precautions 3

Be sure to read this before handling the products.

Refer to back page 50 for Safety Instructions and pages 17 to 19 for 2 Port Solenoid Valve for Fluid Control Precautions.

### Piping

#### Warning

1. During use, deterioration of the tube or damage to the fittings could cause tubes to come loose from their fittings and thrash about.

To prevent uncontrolled tube movement, install protective covers or fasten tubes securely in place.

2. For piping the tube, fix the product securely using the mounting holes so that the product is not in the air.

#### Caution

##### 1. Preparation before piping

Before piping is connected, it should be thoroughly blown out with air (flushing) or washed to remove chips, cutting oil and other debris from inside the pipe.

Install piping so that it does not apply pulling, pressing, bending or other forces on the valve body.

2. Avoid connecting ground lines to piping, as this may cause electric corrosion of the system.

##### 3. Connection of piping and fittings

When screwing piping or fittings into the valve, tighten them as follows.

- When using SMC's fittings, follow the procedures below to tighten them.

###### • Connection thread: M5

First, tighten by hand, then use a suitable wrench to tighten the hexagonal portion of the body an additional 1/6 to 1/4 turn. The reference value for the tightening torque is 1 to 1.5 N·m.

\* For resin bodies, the proper tightening torque is 0.4 to 0.6 N·m (reference value).

###### • Connection thread: M6

First, tighten by hand, then use a suitable wrench to tighten the hexagonal portion of the body an additional 1/6 to 1/4 turn.

\* Excessive tightening may damage the thread portion or deform the gasket and cause air leakage.

Insufficient tightening may loosen the threads or cause air leakage.

###### • Fittings with sealant: R, NPT

First, tighten the fitting by hand, then use a suitable wrench to tighten the hexagonal portion of the body a further two or three turns.

For the tightening torque, refer to the table below.

Connection thread size (R, NPT)	Proper tightening torque (N·m)
1/8	3 to 5

- When using a fitting other than an SMC fitting, follow the instructions given by the fitting manufacturer.

##### 4. Connection of piping to products

When connecting piping to a product, refer to its operation manual to avoid mistakes regarding the supply port, etc.

##### 5. Winding of sealant tape

When connecting pipes, fittings, etc., be sure that chips from the pipe threads and sealing material do not enter the valve. Furthermore, when sealant tape is used, leave 1.5 to 2 thread ridges exposed at the end of the threads.

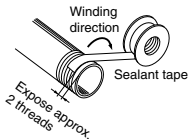

6. In applications such as vacuum and non-leak specifications, use caution specifically against the contamination of foreign objects or airtightness of the fittings.

### Recommended Piping Conditions

1. When connecting tubes using one-touch fittings, provide some spare tube length shown in Fig. 1, recommended piping configuration.

Also, do not apply external force to the fittings when binding tubes with bands, etc. (see Fig. 2.)

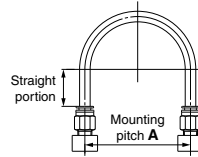

Fig. 1 Recommended piping configuration

Unit: mm

Tube size	Mounting pitch A			Straight portion length
	Nylon tube	Soft nylon tube	Polyurethane tube	
ø3.2	44 or more	29 or more	25 or more	16 or more
ø4	56 or more	30 or more	26 or more	20 or more
ø6	84 or more	39 or more	39 or more	30 or more

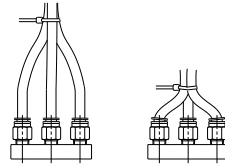

Fig. 2 Binding tubes with bands

### Wiring

#### Caution

1. As a rule, use electric wire with a cross sectional area of 0.5 to 1.25 mm<sup>2</sup> for wiring. Furthermore, do not allow excessive force to be applied to the lines.
2. Use electric circuits which do not generate chattering in their contacts.
3. Use voltage which is within ±10% of the rated voltage. In cases with a DC power supply where importance is placed on responsiveness, stay within ±5% of the rated value. The voltage drop is the value in the lead wire section connecting the coil.

VCH □

VDW

SX10

VQ

LVM



## VDW Series

# Specific Product Precautions 4

Be sure to read this before handling the products.

Refer to back page 50 for Safety Instructions and pages 17 to 19 for 2 Port Solenoid Valve for Fluid Control Precautions.

### Operating Environment

#### Warning

1. Do not use in an atmosphere having corrosive gases, chemicals, sea water, water, water steam, or where there is direct contact with any of these.
2. Do not use in explosive atmospheres.
3. Do not use in locations subject to vibration or impact.
4. Do not use in locations where radiated heat will be received from nearby heat sources.
5. Employ suitable protective measures in locations where there is contact with water droplets, oil or welding spatter, etc.

### Maintenance

#### Warning

##### 1. Removing the product

The valve will reach a high temperature when used with high temperature fluids. Confirm that the valve temperature has dropped sufficiently before performing work. If touched inadvertently, there is a danger of being burned.

- 1) Shut off the fluid supply and release the fluid pressure in the system.
- 2) Shut off the power supply.
- 3) Remove the product.

##### 2. Low frequency operation

Switch valves at least once every 30 days to prevent malfunction. Also, in order to use it under the optimum state, conduct a regular inspection once a half year.

#### Caution

##### 1. Filters and strainers

- 1) Be careful regarding clogging of filters and strainers.
- 2) Replace filter elements after one year of use, or earlier if the pressure drop reaches 0.1 MPa.
- 3) Clean strainers when the pressure drop reaches 0.1 MPa.

##### 2. Lubrication

When using after lubricating, never forget to lubricate continuously.

##### 3. Storage

In case of long term storage after use with heated water, thoroughly remove all moisture to prevent rust and deterioration of rubber materials, etc.

##### 4. Exhaust the drainage from an air filter periodically.

### Operating Precautions

#### Warning

When problems are caused by a water hammer, install water hammer relief equipment (accumulator, etc.), or use an SMC water hammer relief valve (VXR series). For details, please consult with SMC.

### Operating Precautions

#### Caution

When operating the product with flow direction 2 → 1 with pressure supplied to port 2, there is a risk of the valve opening momentarily and fluid leaking to the downstream side due to a rapid increase of the upstream pressure.

A special product will be available when holding pressure supplied from port 2 in the flow direction 2 → 1 with low leakage performance is required.

##### Universal specification

A special can be available for Universal Specification, where product operation can be both flow from port 1 to port 2 (1 → 2) and from port 2 to port 1 (2 → 1).

### Electric Connections

#### Caution

##### ■ Grommet

Class B coil: AWG20 Outside insulator diameter of 1.8 mm

##### 2 port

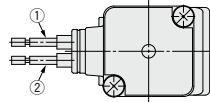

Rated voltage	Lead wire color	
	(1)	(2)
DC	Black	Red
100 VAC	Blue	Blue
200 VAC	Red	Red
Other AC	Gray	Gray

\* There is no polarity.

### Electric Circuits

#### Caution

##### [DC circuit]

##### Grommet

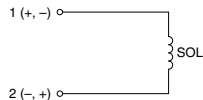

##### [AC circuit]

\* For AC (Class B), the standard product is equipped with surge voltage suppressor.

##### Grommet

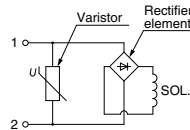

### One-touch Fitting

#### Caution

For information on handling One-touch fittings and on appropriate tubing, refer to page 469 and the Fittings & Tubing section of the "Handling Precautions for SMC Products" on the SMC website.