

Industrial Filters

FGD/FGE/FGG/FGA/FGC Series

Vessel/Elements

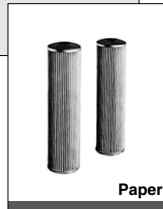
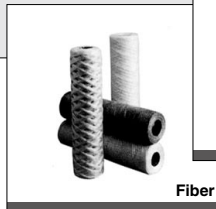
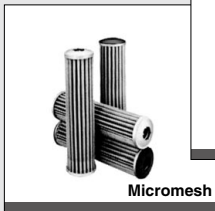
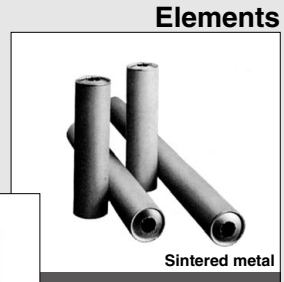
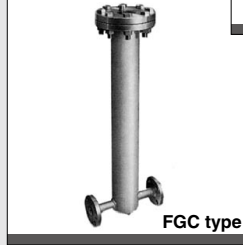
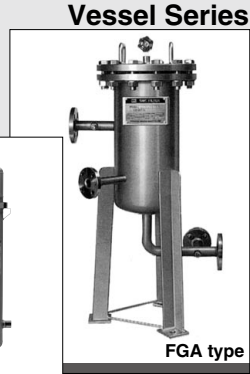
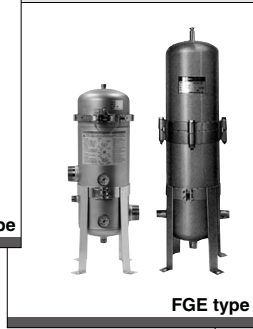

FGD

FGE

FGG

FGA

FGC

FGF

FGH

FQ1

FN

EB

ES





SMC industrial filters are

SMC

Elements can be incorporated
Please use by setting an element



Industrial Filters (FG□ Series)





Series	Application/Specifications	Page
<p>FGD Series</p> <ul style="list-style-type: none"> ● Suitable for low flow rate, low pressure "filtration". ● Can be used with a wide range of fluids. ● Antistatic specifications (FGDE, FGDF) 	<ul style="list-style-type: none"> • Application: Low flow rate filtration (Max. 60 L/min) • Specifications: Maximum operating pressure: 0.7, 1 MPa Port size: Rc3/8, 1/2, 3/4 Body materials: Cover: Aluminum, SCS14 Case: SPCD, Stainless steel 316 	P.24
<p>FGE Series</p> <ul style="list-style-type: none"> ● Suitable for medium flow rate, low pressure "filtration". ● Element replacement is easy with the V-band type. (with cover anti-scattering mechanism) ● Can be used with a wide range of fluids. 	<ul style="list-style-type: none"> • Application: Medium flow rate filtration (Max. 230 L/min) • Specifications: Maximum operating pressure: 0.7 MPa Port size: R1, 2 Body material: Stainless steel 304 	P.29
<p>FGG Series</p> <ul style="list-style-type: none"> ● Suitable for high flow rate, low pressure "filtration". ● Element replacement is easy with the V-band type. (with cover anti-scattering mechanism) 	<ul style="list-style-type: none"> • Application: High flow rate filtration (Max. 350 L/min) • Specifications: Maximum operating pressure: 0.7 MPa Port size: Rc2 (female) Body material: Stainless steel 304 	P.32
<p>FGA Series (Made to Order)</p> <ul style="list-style-type: none"> ● Various types of elements can be selected according to the "filtration conditions", and the unit can be used for a wide range of applications. ● This type has a vertical structure, so there is little loss of "filtrate". ● Maintenance and inspection—element replacement in particular is easy. ● When used for a gas, the product is handled as a class 2 pressure vessel compliant special order product. (Except for products with an internal capacity of less than 40 L) 	<ul style="list-style-type: none"> • Application: High flow rate filtration (Max. 3200 L/min) • Specifications: Maximum operating pressure: 1 MPa Port size: Flange JIS 10KFF 25 to 150 (1^B to 6^B) Body materials: SS400, Stainless steel 304 (wetted parts) 	P.35
<p>FGC Series (Made to Order)</p> <ul style="list-style-type: none"> ● Various types of elements can be selected according to the "filtration conditions", and the unit can be used for a wide range of applications. ● This type has a vertical structure, so there is little loss of "filtrate". ● Maintenance and inspection—element replacement in particular is easy. 	<ul style="list-style-type: none"> • Application: Low flow rate filtration (Max. 80 L/min) Filtration of high-pressure fluid • Specifications: Maximum operating pressure: 1, 2, 4 MPa Port size: Flange JIS 10KFF (FGC1) 15 to 25 (1/2^B to 1^B) JPI300^{LB}RF (FGC2) JPI600^{LB}RF (FGC4) Body materials: SS400, Stainless steel 304 (wetted parts) 	P.38

active in all fields of industry.

Filters

into any type of vessel for SMC filters.
suited to the application in the vessel.

Elements

Element	Series	Material	Nominal filtration accuracy (µm)	Main applications	Page
● Sintered metal 	EB	Bronze	1, 2, 5, 10 20, 40, 70 100, 120	All types of gases/liquids, General solvents, High-temperature fluids	P.41
	ES	Stainless steel 316	1, 2, 5, 10 20, 40, 70 100, 120		
● Fiber (Honeycomb) 	EH	Cotton	0.5, 1, 5, 10 20, 50, 75, 100	General solvents, General neutral fluids	P.41
	EHM	Polypropylene	0.5, 1, 5, 10 20, 50, 75, 100	Plating fluids, General acids, Alkali fluids, Industrial water, Cooling water	
	EHK	Glass fiber	1, 5, 10, 20	General acids, High-temperature fluids	
● Paper 	EP	Cotton, Phenol impregnated, (Epoxy adhesion)	5, 10, 20	Hydraulic oil, Lubricating oil, Fuel oil	P.42
● Micromesh 	EM100	Stainless steel 304 (Epoxy adhesion)	5, 10, 20, 40 74, 105	All types of gases/liquids, High-temperature fluids	P.42
	EM500	Stainless steel 316	5, 10, 20, 40 74, 105		

FGD

FGE

FGG

FGA

FGC

FGF

FGH

FQ1

FN

EB

ES

Filter Selection by Main Application

FGD/FGE/FGG type

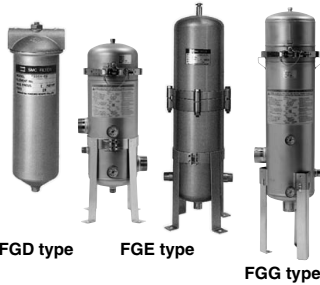

Applications and Applicable Element

●: Recommended ○: Can be used ×: Cannot be used

Fluid name	Applicable element type, material	Nominal filtration accuracy (μm)	Applicable filter model								
			FGDC	FGDE	FGDT	FGDF	FGES	FGE L	FGET	FGGS	FGGL
Industrial water	Fiber element Polypropylene	10	×	×	●	○	●	○	○	●	○
Water for cleaning	Fiber element Polypropylene	20	×	×	●	○	●	○	○	●	○
Water	Fiber element Polypropylene	20	×	×	●	○	●	○	○	●	○
Fragrances	Fiber element Cotton	10	×	×	●	○	●	○	○	●	○
Hot water	Micromesh element Stainless steel 316	10	×	×	●	○	●	○	○	●	○
General solvents	Micromesh element Stainless steel 316	40	×	×	○	●	×	×	●	×	×
Grinding fluid (Grinding machines)	Fiber element Polypropylene	10	○	●	○	●	●	○	○	●	○
Grinding fluid (Oilstone)	Fiber element Polypropylene	10	○	●	○	●	●	○	○	●	○
Lubricating oil	Fiber element Polypropylene	10	○	●	○	●	●	○	○	●	○
Cooling water	Fiber element Polypropylene	50	×	×	●	○	●	○	○	●	○
Cleaning water	Fiber element Polypropylene	10	×	×	●	○	●	○	○	●	○
Developing fluid	Fiber element Polypropylene	10	×	×	●	○	●	○	○	●	○
Lacquer	Fiber element Cotton	50	×	×	○	●	×	×	●	×	×
Nitrogen gas	Fiber element Cotton	10	●	○	●	○	×	×	●	×	×
Carbon dioxide	Fiber element Cotton	10	●	○	●	○	×	×	●	×	×
Air (Dry)	Fiber element Cotton	0.5 to 10	●	○	●	○	×	×	●	×	×

Note) Please refer to "How to Order" for each series when a filter vessel is combined with an element.

Filter Selection by Main Application

●How to read the chart

Example)

- Application: Scale removal in water for cleaning
- Treatment flow rate: 170 L/min
- Nominal filtration accuracy: Left up to the manufacturer
- Port size: 2

For the above specifications, first see "Applications and Applicable Element". The applicable element for water for cleaning is polypropylene, with a nominal filtration accuracy of 20 µm, and the applicable filter model are all models except FGDC and DGDE.

Next, see "Applicable Filter and Treatment Flow Rate". Follow the item where the fluid name is water for cleaning to the bottom, and at the point where the specifications are 170 L/min or more, see the left. The filter models FGESA, FGELA and FGETA are the applicable filter models.

Therefore, the selected filter model and element are:

Filter model = FGESA-20

Element = Polypropylene 20 µm
(EHM15R10A)

FGD

FGE

FGG

FGA

FGC

FGF

FGH

FQ1

FN

EB
ES

Applicable Filter and Treatment Flow Rate

*Indicates the flow rate (L/min) when the initial pressure drop (including vessel resistance) is 0.0015 MPa (for gas) or 0.015 MPa (for fluid).

Fluid name Applicable element Nominal filtration accuracy (µm)		Air (Dry)		Industrial water				Lubricating oil (20 mm ² /s)	Fragrances (1 mm ² /s)
		Cotton		Polypropylene				Paper	Micromesh
Applicable filter model		0.5 ^{Note 1)}	10 ^{Note 1)}	1	5	10	20	10	5
FGDCA FGDEA FGDTA FGDFA	03	110	550	11	21	23	26	22	29
	04	110	750	12	27	30	36	28	42
	06	110	1000	13	32	36	46	32	57
	FGDCB FGDEB FGDTB FGDFB	03	200	600	17	25	26	28	26
	04	200	840	21	35	37	41	38	44
	06	210	1200	23	46	50	56	50	63
FGESA ^{Note 2)}	10	410	3000	45	90	120	140	100	160
FGELA ^{Note 2)}	20	410	3600	50	120	140	170	110	210
FGETA									
FGESB ^{Note 2)}	10	800	3300	70	140	150	160	120	170
FGELB ^{Note 2)}	20	800	4200	90	170	180	210	140	230
FGETB									
FGESC ^{Note 2)}	10	1100	3400	83	150	160	170	120	170
FGELC ^{Note 2)}	20	1200	4400	120	190	200	220	150	230
FGETC									
FGGSB FGGLB		—	—	160	270	300	320	290	360
FGGSC FGGLC		—	—	200	300	320	340	320	370
FGGSD FGGLD		—	—	230	320	330	350	330	370

Note 1) Indicates flow rate in L/min under atmospheric pressure (ANR) (at 0.5 MPa).

Note 2) Gases cannot be used.

Note 3) Please consult SMC for high flow rates other than the above.

Industrial Filter

FGD Series

How to Order

FGD **C** **A** - **03** - **B** **002** **N**

Element length

Symbol	Element length
A	L250
B	L500 (L250 x 2)

Port size

Symbol	Port size Rc
03	3/8
04	1/2
06	3/4

Accessory

Symbol	Accessory
Nil	None
-B	Bracket

Element category

Symbol	Element type	Material
B	Sintered metal	Bronze
		Stainless steel
T	Fiber (Honeycomb)	Polypropylene
G		Glass fiber
H		Cotton
P		Cotton
M	Micromesh	Stainless steel 304/Epoxy
L		Stainless steel 316
J	HEPO II	Polyester/Polypropylene

Element seal material ^{Note)}

Symbol	Element seal material
A	Non-asbestos
T	Fluororesin
N	NBR
V	FKM

Note) Refer to the below table for the element seal material types by the element category.

Material

Symbol	Cover	Case	Gasket/O-ring	Seal
C	Aluminum	SPCD	NBR	Nylon
E	Aluminum	SPCD	NBR	Nylon/Fluororesin (Antistatic specifications)
T	SCS14	Stainless steel 316	Fluororesin	Fluororesin
F	SCS14	Stainless steel 316	Fluororesin	Fluororesin (Antistatic specifications)

Note) If there is a static charge, select a product with an antistatic specification.

Nominal filtration accuracy (μm) ^{Note)}

Symbol	Nominal filtration accuracy (μm)
X50	0.5
001	1
002	2
005	5
010	10
020	20
040	40
050	50
070	70
074	74
075	75
100	100
105	105
120	120

Note) For a comparison with the nominal filtration accuracy according to the element category, refer to pages 41 and 42.

Element/Element Seal Material Combinations

Element material	Element seal material		PTFE	NBR	FKM
	Nil (Without seal)	Non-asbestos			
	A	T	N	V	
B Bronze		○	○	○	○
S Stainless steel		○	○	○	○
T Polypropylene	○				
G Glass fiber	○				
H Cotton (Fiber)	○				
P Cotton (Paper)				○	○
M Stainless steel 304/Epoxy				○	○
L Stainless steel 316		○	○	○	○
J Polyester/PP			○	○	○

Note 1) The industrial filter described in this catalog are products in which an element is incorporated into a vessel.

Note 2) To order only an element (replacement part), refer to "How to Order" on pages 41 and 42.

Note 3) When ordering only a vessel (replacement part), delete each symbol for "Element category", "Nominal filtration accuracy (μm)" and "Element seal material" from the above "How to Order."

Note 4) Please use industrial filters in combination with parts made by SMC (vessels, elements etc.)

FGDT, F



FGDC, E



- Suitable for low flow rate, low pressure "filtration."
- Can be used with a wide range of fluids.
- Antistatic specifications (FGDE, FGDF)

Specifications

Model	FGDCA	FGDCB	FGDEA	FGDEB	FGDTA	FGDTB	FGDFA	FGDFB
Port size (Rc)					3/8, 1/2, 3/4			
Max. operating pressure (MPa) ^{Note 1)}	0.7				1			
Operating temperature (°C)	0 to 80							
Number of elements	1	2 ^{Note 2)}	1	2 ^{Note 2)}	1	2 ^{Note 2)}	1	2 ^{Note 2)}
Element size	ø65 to 70 x L250	ø65 to 70 x L500 (L250 x 2)	ø65 to 70 x L250	ø65 to 70 x L500 (L250 x 2)	ø65 to 70 x L250	ø65 to 70 x L500 (L250 x 2)	ø65 to 70 x L250	ø65 to 70 x L500 (L250 x 2)
Main materials ^{Note 3)}	Cover	Aluminum			SCS14			
	Case	SPCE			Stainless steel 316			
	Gasket/O-ring	NBR			Fluororesin			
	Seal	Nylon		Nylon/Fluororesin		Fluororesin		
Weight (kg)	1.3	2.2	1.3	2.2	2.3	3.8	2.3	3.8
Internal capacity (L)	1.7	3.4	1.7	3.4	1.7	3.4	1.7	3.4

Note 1) For gases, 0.5 MPa.

Note 2) 1 element (ø65 x L500) in the case of a sintered metal element or paper element.

Note 3) The sealing performance of nylon and fluororesin seals may decrease over time. Periodically check the tightening torque specified in the operation manual.

Replacement Parts and Seal List

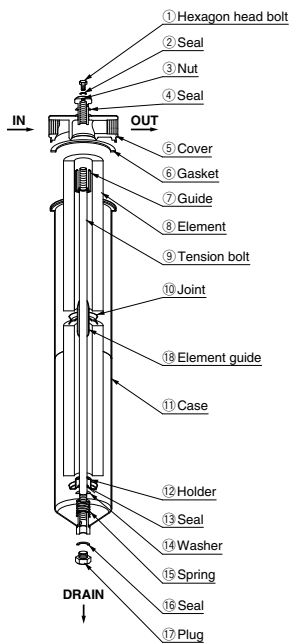

Parts descriptions and functions

(Figure shows the product with two FGD□B elements.)

Note) There is no compatibility between the FGDT/F and FGDC/E as the seal structure on the gasket portion is different. Use the cover and case of the same model.

Parts Descriptions and Functions

No.	Description	Material	Function
1	Hexagon head bolt	Stainless steel or iron	Plug to release air in the housing
2	Seal	Resin	
3	Nut	Stainless steel or iron	Tightens the cover.
4	Seal	Resin	
5	Cover	Stainless steel or Aluminum	The lid of the filter body
6	Gasket	Resin or rubber	
7	Guide	Stainless steel	Seals the gap between the element and tension bolt.
8	Element	Depends on the element type.	The mounted element collects residue.
9	Tension bolt	Stainless steel or iron	Connects the case and cover.
10	Joint	Stainless steel	Seals the area between elements. (when two FGD□B elements are used)
11	Case	Stainless steel or iron	Filter body
12	Holder	Stainless steel	Seals the elements.
13	Seal	Resin or rubber	
14	Washer	Stainless steel	
15	Spring	Stainless steel	Stabilizes the element.
16	Seal	Resin	
17	Plug	Stainless steel or iron	Drainage discharging plug
18	Element guide	Stainless steel or iron	

Replacement Parts

Description	Part no.	Applicable model	Part no. (Kit contents)
Nut kit	FGD-KT001	FGDC	①, ②, ③, ④: 1 pc. each
	FGD-KT002	FGDE	
	FGD-KT003	FGDT	
	FGD-KT004	FGDF	
Replacement cover	FGD-CV005- ⁰³ / ₀₄ / ₀₆	FGDT/F	⑤
	FGD-CV006- ⁰³ / ₀₄ / ₀₆	FGDC/E	
Joint	FGD-OP001	FGDI	⑩
Seal kit	KT-FGDC	FGDC	②, ④, ⑥, ⑬, ⑯: 1 pc. each
	KT-FGDE	FGDE	
	KT-FGDT	FGDT	
	KT-FGDF	FGDF	
Replacement case assembly	FGD-CA002	FGDT/F(L250)	⑦, ⑨, ⑪, ⑫, ⑬, ⑭, ⑮, ⑯, ⑰ : 1 pc. each Note) Only the FGD-CA003 and CA005 includes ⑱ element guide in the set.
	FGD-CA003	FGDT/F(L500)	
	FGD-CA004	FGDC/E(L250)	
	FGD-CA005	FGDC/E(L500)	

FGD

FGE

FGG

FGA

FGC

FGF

FGH

FQ1

FN

EB

ES

FGD Series

Dimensions

FGD□A (1 element)

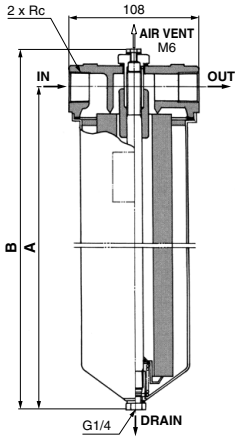

FGD□B (2 elements)

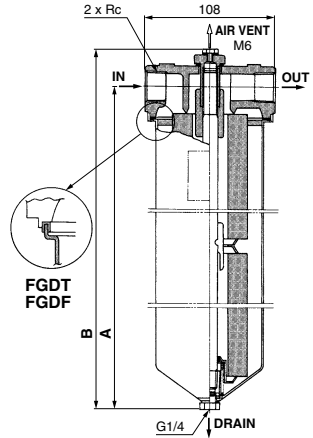

* Element removal dimension: 50 mm

Model	Element length	A	B	Port size Rc
FGDC	A (L250)	314	346	3/8, 1/2, 3/4
FGDE	B (L500)	574	606	
FGDT	A (L250)	314	349	
FGDF	B (L500)	574	608	

Accessory/Bracket

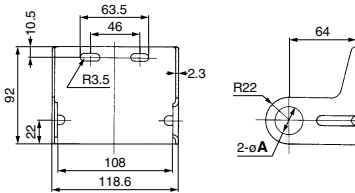

Part no.	φA	Port size Rc	Material	Surface treatment
BP-1S	17.5	3/8	SPCC	Zinc chromated
BP-2S	22	1/2		
BP-3S	27.5	3/4		

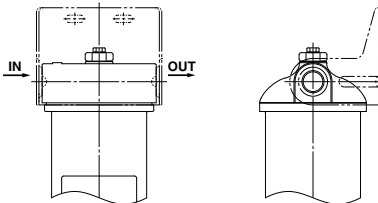

Mounting position

Note) Secure the filter with steel piping.
Use this bracket for piping support.
(Flexible piping cannot be used to secure the filter.)

FGD Series Made to Order

Consult with SMC for details.



Symbol

1 With Differential Pressure Indicator (X77), With Differential Pressure Indication Switch (X78) -X77, -X78

The replacement period due to clogging of the element can be checked visually (X77), and a built-in contact enables the output of an electrical signal (X78).

Applicable models

- FGDC, FGDE
- FGDT, FGDF

Note 1) A magnet is used on the wetted parts.

Note 2) For the FGDT and the FGDE, the material of the filter body and that of the O-ring differ.

Note 3) Be sure to check whether the fluid to be used is compatible with the product in advance.

How to Order

Standard model no.*

● Made to Order

Symbol	Description
Nil	None
X77	With differential pressure indicator
X78	With differential pressure indication switch

* Refer to How to Order of the standard specifications for the applicable models

FGD

FGE

FGG

FGA

FGC

FGF

FGH

FQ1

FN

EB

ES

Differential Pressure Indication

■ Differential pressure indicator

- Operation pressure—0.1±0.02 MPa
- Once a value is displayed, it will continue to be displayed until reset, even if the pump is stopped. (Reset type)
- Perform element replacement when the red ring floats up and covers the entire inspection window.

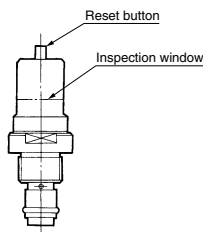

■ Differential pressure indication switch

- Operating pressure—0.1±0.02 MPa
- When a value has been displayed, it will be automatically reset when the pump is stopped. (Non-reset type)
- This is a visual dual-purpose. Perform element replacement when the switch has actuated (when the red ring floats up and covers the entire inspection window).
- N.C. and N.O. common

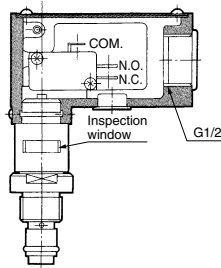

Microswitch Ratings

Rated voltage (V)	Noninductive load (A)				Inductive load (A)			
	Resistance load	Light load	Inductive load	Motor load	Normally closed	Normally open	Normally closed	Normally open
AC125	5	1.5	0.7	4	2.5	1.3		
AC250	5	1	0.5	4	1.5	0.8		
DC8	5	3		5	4	3		
DC14	5	3		4	3			
DC30	5	3		4	3			
DC125	0.4	0.1		0.4	0.1			
DC250	0.3	0.05		0.3	0.05			

Precautions

1. The figures in the above table indicate stationary current.
2. An inductive load has a power factor (AC) of 0.75 or more, and a time constant (DC) of 7 msec or less.
3. A light load has an inrush current 10 times greater.
4. Lead wires are connected using a soldering terminal.
5. The electrical entry is equipped with a conduit (G1/2) and grommet.
6. Please wire freely to the microswitch indication symbol 1(COM.), 2(N.C.) and 3(N.O.).
7. If a holding mechanism is necessary for the non-reset type, provide it using electric circuits.

Differential Pressure Indicator/Switch Part No.

Applicable model	Part no.	
	Differential pressure indicator	Differential pressure indication switch
FGDC, E	CB-62H	CB-63H
FGDT, F	CB-60H	CB-61H

FGD Series

Specifications

Model		FGDCA/FGDEA (X77, X78)	FGDCB/FGDEB (X77, X78)	FGDTA/FGDFA (X77, X78)	FGDTB/FGDFB (X77, X78)
Max. operating pressure (MPa)		0.7			1.0
Operating temperature (°C)		0 to 80			
Differential pressure indicator operating pressure Differential pressure indication switch operating pressure (MPa)		0.1±0.02			
Port size		Rc3/8, 1/2, 3/4			
Differential pressure indicator/ Differential pressure indication switch Material	Body	Aluminum		Stainless steel 303	
	Seal	NBR		FKM	
Weight (kg)	X77	1.3	2.2	2.3	3.8
	X78	1.5	2.4	2.5	4.0
Internal volume (L)		1.7	3.4	1.7	3.4

(Note) Refer to "Specifications" on page 25 for details on the materials of the cover, case, etc.

Dimensions

With differential pressure indicator (X77)

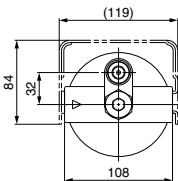

Replacement Cover Assembly (X77) One set each of cover and differential pressure indicator

Part no.	Applicable model
FGD-CV002- ⁰³ ₀₄ ₀₆	FGDT/F
FGD-CV003- ⁰³ ₀₄ ₀₆	FGDC/E

Note 1) Same as standard product except for cover assembly

Note 2) 03, 04, and 06 indicate the relevant port sizes (Rc3/8, 1/2, 3/4).

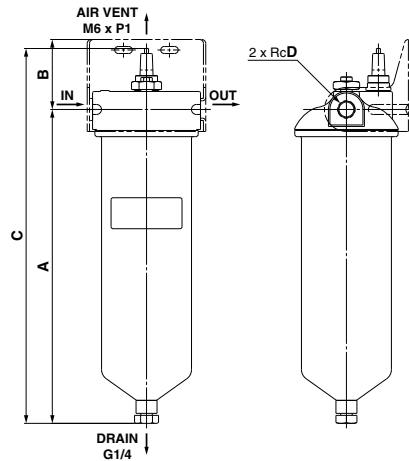

Model	Element length	A	B	C	D
FGDC	A (L250)	314	70	374	3/8, 1/2, 3/4
	B (L500)	574	70	634	
FGDT	A (L250)	315	70	375	
	B (L500)	574	70	636	

With differential pressure indication switch (X78)

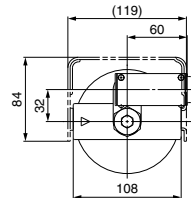

Replacement Cover Assembly (X78) One set each of cover and differential pressure indicator

Part no.	Applicable model
FGD-CV004- ⁰³ ₀₄ ₀₆	FGDT/F
FGD-CV001- ⁰³ ₀₄ ₀₆	FGDC/E

Note 1) Same as standard product except for cover assembly

Note 2) 03, 04, and 06 indicate the relevant port sizes (Rc3/8, 1/2, 3/4).

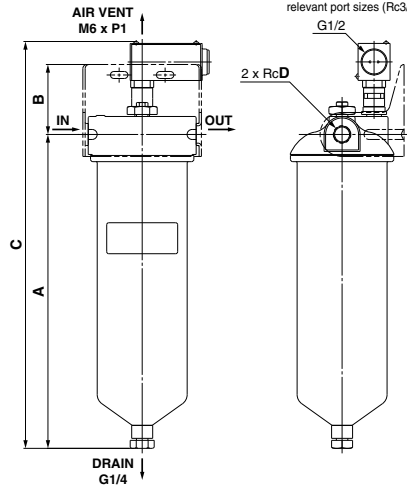

Model	Element length	A	B	C	D
FGDC	A (L250)	314	70	407	3/8, 1/2, 3/4
	B (L500)	574	70	665	
FGDT	A (L250)	315	70	408	
	B (L500)	574	70	665	

Industrial Filter

FGE Series

How to Order

FGES/FGEL type (V-band type) **FGE S A-10-B 002 N A-G1**

Symbol	Body	Gasket/O-ring
S	Stainless steel 304	NBR
L	Stainless steel 304	FKM

Symbol	Pressure gauge type
G1	G46-10-02M (Brass at wetted parts)
G2	G46-10-02-SRB (Stainless steel at wetted parts)
Nii	None (with plug)

* Please use the applicable pressure gauge depending on the fluid used.
Control the differential pressure even when none pressure gauge is selected.

FGET type (Bolt tightening type) **FGE T A-10-B 002 N**

Symbol	Body	Gasket/O-ring
T	Stainless steel 304	Fluororesin

Element length

Symbol	Element length
A	L250
B	L500 (L250 x 2)
C	L750 (L250 x 3)

Port size

Symbol	Port size R
10	1
20	2

Element category

Symbol	Element type	Material
B	Sintered metal	Bronze
S		Stainless steel
T	Fiber	Polypropylene
G		Glass fiber
H		Cotton
P	Paper	Cotton
M	Micromesh	Stainless steel 304/Epoxy
L		Stainless steel 316
J	HEPO II	Polyester/Polypropylene

Element seal material (Note)

Symbol	Element seal material
A	Non-asbestos
T	Fluororesin
N	NBR
V	FKM

Note) Refer to the below table for the element seal material types by the element category.

Nominal filtration accuracy (μm) (Note)

Symbol	Nominal filtration accuracy (μm)	Symbol	Nominal filtration accuracy (μm)
X50	0.5	050	50
001	1	070	70
002	2	074	74
005	5	075	75
010	10	100	100
020	20	105	105
040	40	120	120

Note) For a comparison with the nominal filtration accuracy according to the element category, refer to pages 41 and 42.

Element/Element Seal Material Combinations

Element seal material		Element material				
		Nii (Without seal)	Non-asbestos	PTFE	NBR	FKM
Element material		A	T	N	V	
B Bronze			○	○	○	
S Stainless steel		○	○	○	○	
T Polypropylene	○					
G Glass fiber	○					
H Cotton (Fiber)	○					
P Cotton (Paper)				○	○	
M Stainless steel 304/Epoxy				○	○	
L Stainless steel 316		○	○	○	○	
J Polyester/PP			○	○	○	



FGES/FGEL type
(V-band type)

FGET type
(Bolt tightening type)

- Suitable for medium flow rate, low pressure "filtration."
- Element replacement is easy with the V-band type. (with cover anti-scattering mechanism)
- Can be used with a wide range of fluids

Note 1) The industrial filter described in this catalog are products in which an element is incorporated into a vessel.

Note 2) To order only an element (replacement part), refer to "How to Order" on pages 41 and 42.

Note 3) When ordering only a vessel (replacement part), delete each symbol for "Element category", "Nominal filtration accuracy (μm)" and "Element seal material" from the above model indication method.

Note 4) Please use industrial filters in combination with parts made by SMC (vessels, elements etc.)

Note 5) Do not use the V-band type for gases.

Specifications

Model	FGESA ^{Note 1)}	FGESB ^{Note 1)}	FGESC ^{Note 1)}	FGELA ^{Note 1)}	FGELB ^{Note 1)}	FGELC ^{Note 1)}	FGETA	FGETB	FGETC	
Port size (R)	1, 2									
Max. operating pressure (MPa)	0.7									
Operating temperature (°C)	0 to 80 (60 with pressure gauge)									
Number of elements	4	4 ^{Note 2)}	8	4 ^{Note 2)}	12	4	4 ^{Note 2)}	8	4 ^{Note 2)}	
Element size	ø65 to 70 x L250	ø65 to 70 x L500	ø65 to 70 x L250	ø65 to 70 x L750	ø65 to 70 x L250	ø65 to 70 x L250	ø65 to 70 x L500	ø65 to 70 x L250	ø65 to 70 x L750	
Main materials	Cover	Stainless steel 304								
	Case	Stainless steel 304								
	Gasket	—	—	—	—	—	Fluororesin	Fluororesin	Fluororesin	
	O-ring	NBR			FKM			—		
	Legs	SS400 (Chromatic plating)								
Weight (kg)	10	13	18	10	13	18	12	15	20	
Internal capacity (L)	14	21	29	14	21	29	11.5	18.5	26	

Note 1) Cannot be used with gases.

Note 2) In the case of a sintered metal element or paper element.

Replacement Parts and Seal List

FGES/FGEL type (V-band type)

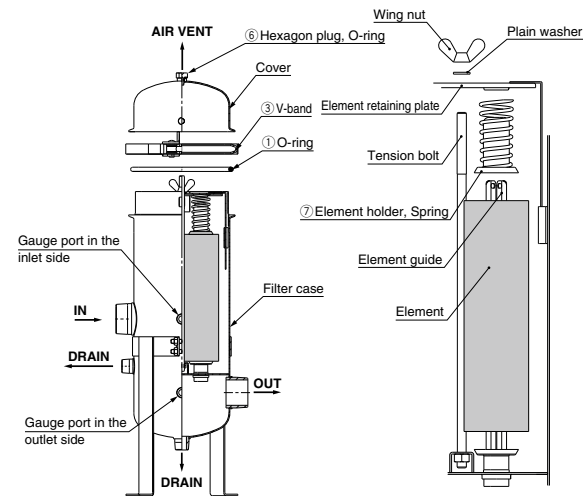

FGET type (Bolt tightening type)

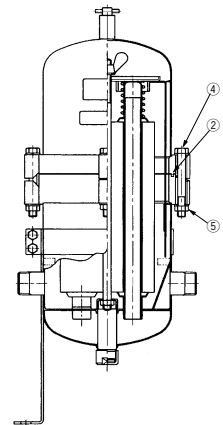

No.	Description	Qty.	Applicable model		
			FGES	FGEL	FGET
1	O-ring	1	FGE-KT001	FGE-KT002	—
2	Gasket	1	—	—	AL-19S
3	V-band	1	CY-24S		—
4	Hexagon head bolt	4	—	—	CB00021
5	Hexagon nut	4	—	—	DA00110
6	Hexagon plug	1	FGE-OP007	FGE-OP008	—
	O-ring	1			
7	Spring	4	FGE-OP005		
	Element holder	4			

Dimensions

FGES/FGEL type (V-band type)

FGET type (Bolt tightening type)

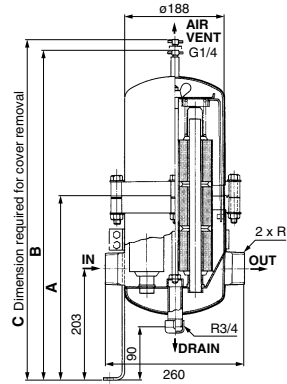
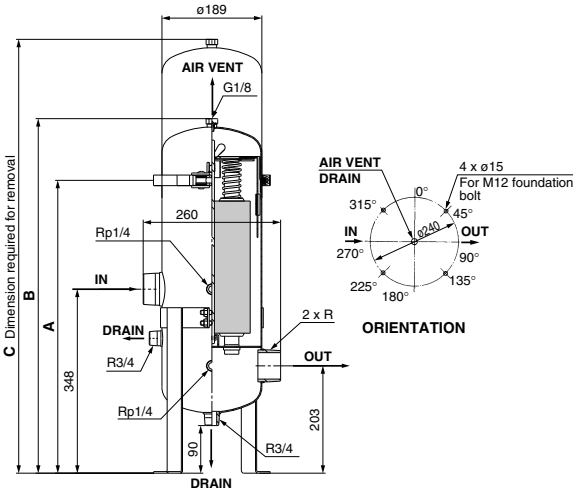

- FGD
- FGE**
- FGG
- FGA
- FGC
- FGF
- FGH
- FQ1
- FN
- EB
- ES

FGES type (V-band type) (mm)

Model	A	B	C	Port size R
FGESA		671	850	1, 2
FGESB	554	931	1350	
FGESC		1191	1860	

FGEL type (V-band type) (mm)

Model	A	B	C	Port size R
FGELA		671	850	1, 2
FGELB	554	931	1325	
FGELC		1191	1825	

FGET type (Bolt tightening type) (mm)

Model	A	B	C	Port size R
FGETA	366	612	910	1, 2
FGETB	516	871	1225	
FGETC	647	1133	1620	

Industrial Filter

FGG Series

How to Order

FGG S B - 20 - B 002 N A - G1

Material

Symbol	Body	O-ring
S	Stainless steel 304	NBR
L	Stainless steel 304	FKM

Element length

Symbol	Element length
B	L500 (L250 x 2)
C	L750 (L250 x 3)
D	L1000 (L250 x 4)

Port size

Symbol	Port size Rc
20	2

Element category

Symbol	Element type	Material
B	Sintered metal	Bronze
S		Stainless steel
T	Fiber (Honeycomb)	Polypropylene
G		Glass fiber
H		Cotton
P	Paper	Cotton
M	Micromesh	Stainless steel 304/Epoxy
L		Stainless steel 316

Nominal filtration accuracy (μm) ^{Note)}

Symbol	Nominal filtration accuracy (μm)
X50	0.5
001	1
002	2
005	5
010	10
020	20
040	40
050	50
070	70
074	74
075	75
100	100
105	105
120	120

Note) For a comparison with the nominal filtration accuracy according to the element category, refer to pages 41 and 42.



- Suitable for high flow rate, low pressure "filtration."
- Element replacement is easy with the V-band type. (with cover anti-scattering mechanism)

Option

Symbol	Pressure gauge type
G1	G46-10-02M (Brass at wetted parts)
G2	G46-10-02-SRB (Stainless steel at wetted parts)
Nil	None (with plug)

* Please use the applicable pressure gauge depending on the fluid used. Control the differential pressure even when none pressure gauge is selected.

Element seal material ^{Note)}

Symbol	Element seal material
A	Non-asbestos
T	Fluororesin
N	NBR
V	FKM

Note) Refer to the below table for the element seal material types by the element category.

Element/Element Seal Material Combinations

Element material	Element seal material (Without seal)	Element seal material				
		Nil (Without seal)	Non-asbestos	PTFE	NBR	FKM
		A	T	N	V	
B Bronze			○	○	○	
S Stainless steel		○	○	○	○	
T Polypropylene	○					
G Glass fiber	○					
H Cotton (Fiber)	○					
P Cotton (Paper)				○	○	
M Stainless steel 304/Epoxy				○	○	
L Stainless steel 316		○	○	○	○	

Note 1) The industrial filter described in this catalog are products in which an element is incorporated into a vessel.

Note 2) To order only an element (replacement part), refer to "How to Order" on pages 41 and 42.

Note 3) When ordering only a vessel (replacement part), delete each symbol for "Element category", "Nominal filtration accuracy (μm)" and "Element seal material" from the above "How to Order".

Note 4) Please use industrial filters in combination with parts made by SMC (vessels, elements etc.)

Note 5) Do not use this filter for gases.

Specifications

Model	FGGSB ^{Note 1)}		FGGSC ^{Note 1)}		FGGSD ^{Note 1)}		FGGLB ^{Note 1)}		FGGLC ^{Note 1)}		FGGLD ^{Note 1)}		
Port size (Rc)	2												
Max. operating pressure (MPa)	0.7												
Operating temperature (°C)	0 to 80 (60 with pressure gauge)												
Number of elements	7 ^{Note 2)}		14		7 ^{Note 2)}		21		7 ^{Note 2)}		28		
Element size	ø65 x L500	ø65 x L250	ø65 x L750	ø65 x L250	ø65 x L1000	ø65 x L250	ø65 x L500	ø65 x L250	ø65 x L750	ø65 x L250	ø65 x L1000	ø65 x L250	
Main materials	Cover	Stainless steel 304											
	Case	Stainless steel 304											
	O-ring	NBR						FKM					
	Legs	SS400 (Chromatic plating)											
Weight (kg)	19.5		23		30		19.5		23		30		
Internal volume (L)	27		43		52		27		43		52		

Note 1) Cannot be used with gases.

Note 2) In the case of a sintered metal element or paper element.

Replacement Parts and Seal List

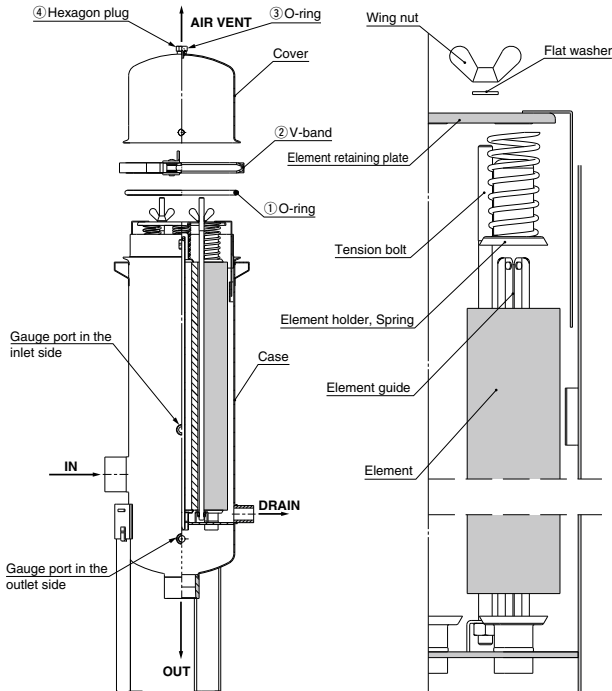

No.	Description	Qty.	Applicable model	
			FGGS	FGGL
1	O-ring	1	FGF-KT01	FGF-KT02
2	V-band	1	CY-27S	
3	O-ring	1	FGE-OP007	FGE-OP008
4	Hexagon plug	1		

FGD

FGE

FGG

FGA

FGC

FGF

FGH

FGI

FGJ

FGK

FGM

FGN

FGO

FGP

FGQ

FGR

FGS

FGT

FGU

FGV

FGW

FGX

FGY

FGZ

FGG Series

Dimensions

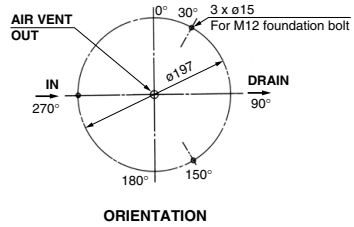
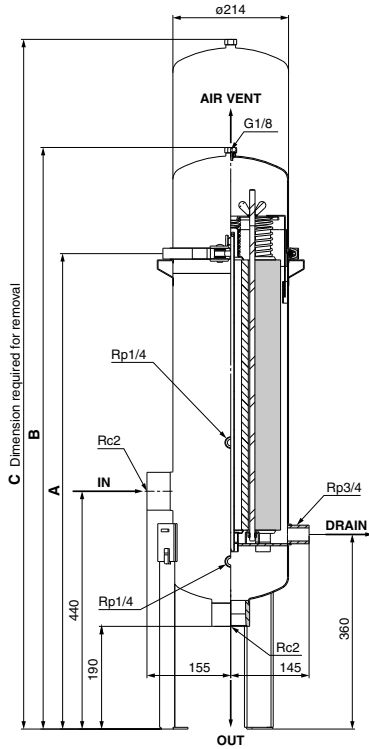

Model	A	B	C* (mm)
FGGSB FGGLB	880	1077	1180 to 1415
FGGSC FGGLC	1147	1344	1440 to 1930
FGGSD FGGLD	1417	1614	1710 to 2450

* The "C" dimension varies depending on the length of the incorporated element.

Industrial Filter

FGA Series

(Produced upon receipt of order)

How to Order

FGA C 04 A - 10 - B 002 N

Wetted parts material (Vessel)

Symbol	Wetted parts material
C	SS400
S	Stainless steel 304

Element seal material ^(Note)

Symbol	Element seal material
A	Non-asbestos
T	Fluororesin
N	NBR
V	FKM

(Note) Refer to the below table for the element seal material types by the element category.

Nominal filtration accuracy (μm) ^(Note)

Symbol	Nominal filtration accuracy (μm)
X50	0.5
001	1
002	2
005	5
010	10
020	20
040	40
050	50
070	70
074	74
075	75
100	100
105	105
120	120

(Note) For a comparison with the nominal filtration accuracy according to the element category, refer to pages 41 and 42.

Element/Element Seal Material Combinations

Element material	Element seal material	Element seal material				
		Nii (Without seal)	Non-asbestos	PTFE	NBR	FKM
		A	T	N	V	
B Bronze		○	○	○	○	
S Stainless steel		○	○	○	○	
T Polypropylene		○				
G Glass fiber	○					
H Cotton (Fiber)	○					
P Cotton (Paper)				○	○	
M Stainless steel 304/Epoxy				○	○	
L Stainless steel 316		○	○	○	○	

Number of arranged elements

Symbol	Number of arranged elements
04	4
07	7
09	9
18	18
22	22
29	29
34	34
37	37
53	53
83	83

Element length

Symbol	Element length
A	L250
B	L500 (L250 x 2)
C	L750 (L250 x 3)
D	L1000 (L250 x 4)

Port size

Symbol	Port size
10	25 (1 ^B)
14	40 (1 1/2 ^B)
20	50 (2 ^B)
24	65 (2 1/2 ^B)
30	80 (3 ^B)
40	100 (4 ^B)
60	150 (6 ^B)

(Note) The connection method is JIS 10KFF flange connection.

Element category

Symbol	Element type	Material
B	Sintered metal	Bronze
		Stainless steel
S	Fiber	Polypropylene
T		Glass fiber
G	Paper	Cotton
H		Cotton
P	Micromesh	Stainless steel 304/Epoxy
M		Stainless steel 316
L		



- Various types of elements can be selected according to the “filtration conditions,” and the unit can be used for a wide range of applications.
- This type has a vertical structure, so there is little loss of “filtrate.”
- Maintenance — element replacement in particular is easy.
- When used for a gas, the product is handled as a class 2 pressure vessel compliant special order product. (Except for products with an internal capacity of less than 40 L) ^(Note 7)
- Confirm the lead time with each order.

$$\text{Note 1) (Necessary number of elements)} = \left(\frac{\text{Number of arranged elements}}{\text{Element length}} \right) \times \left(\frac{\text{Element length}}{\text{Length per element}} \right)$$

Calculation example) If the number of arranged elements is 7, the element length is L500, and length per element is L250, then:
 (Necessary number of elements) = 7 × $\frac{500}{250}$ = 14

Note 2) The industrial filter/vessel series described in this catalog are products in which an element is incorporated into a vessel.

Note 3) To order only an element (replacement part), refer to “How to Order” on pages 41 and 42.

Note 4) When ordering only a vessel (replacement part), delete each symbol for “Element category”, “Nominal filtration accuracy (μm)” and “Element seal material” from the above “How to Order”.

Note 5) Please use industrial filters in combination with parts made by SMC (vessels, elements etc.)

Note 6) For the “FGAS” model, carbon steel is used and coated with silver in locations except for wetted parts material.

Note 7) For details about the internal capacity, refer to the dimensions on page 37.

FGA Series

Specifications

Standard Specifications

Model	FGA
Max. operating pressure (MPa)	1
Operating temperature (°C)	0 to 80
Port size	25 to 150 (1 ⁸ to 6 ⁹) <small>Note)</small>
Wetted parts material (Vessel)	SS400/Stainless steel 304
Gasket	Non-asbestos

Note) JIS 10KFF is used for this flange.

Applicable Element Specifications

Description	Material	Nominal filtration accuracy (μm)	Size
Sintered metal	Bronze	1, 2, 5, 10, 20, 40 70, 100, 120	ø65 x L250 ø65 x L500 ø65 x L750 ø65 x L1000
	Stainless steel 316		
Paper	Cotton (Phenol)	5, 10, 20	ø65 x L250 ø65 x L500 ø65 x L750 ø65 x L1000
Fiber	Cotton	0.5, 1, 5, 10, 20 50, 75, 100	ø65 x L250
	Polypropylene		
	Glass fiber		
Micromesh	Stainless steel 304	5, 10, 20, 40 74, 105	ø65 x L250
	Stainless steel 316		

Construction

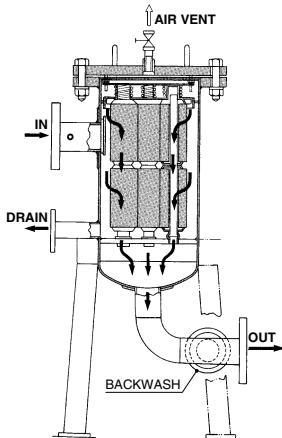

Element mounting figure

Dimensions

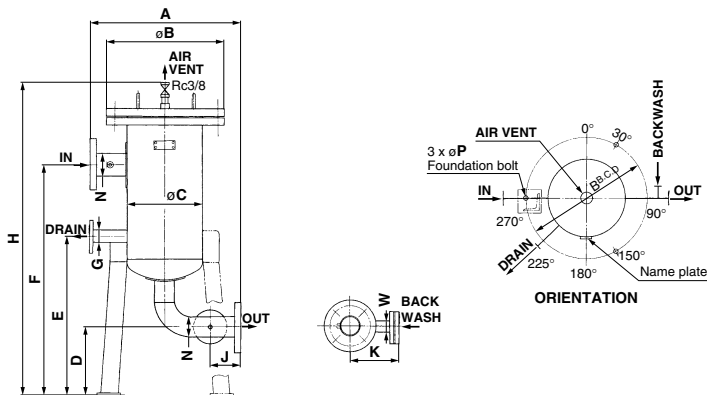

Standard Models

Model	Number of arranged elements	Element length (L)	N (Port size)			G	W	A	øB	øC	D	E	F	H	J	K	øP	Weight (kg)	(mm)		
			Internal volume (L)		ES														EB		
FGAC FGAS	4	250	25 (1 ^B)	40 (1 1/2 ^B)	50 (2 ^B)	20 (3/4 ^B)	20 (3/4 ^B)	500	330	216.3	230	490	660	965	80	120	20	70	15		
	4	500	25 (1 ^B)	40 (1 1/2 ^B)	50 (2 ^B)	20 (3/4 ^B)	20 (3/4 ^B)	500	330	216.3	230	490	905	1220	80	120	20	80	24		
	4	750	25 (1 ^B)	40 (1 1/2 ^B)	50 (2 ^B)	20 (3/4 ^B)	20 (3/4 ^B)	500	330	216.3	230	490	1160	1485	80	120	20	90	32		
	4	1000	25 (1 ^B)	40 (1 1/2 ^B)	50 (2 ^B)	20 (3/4 ^B)	20 (3/4 ^B)	500	330	216.3	230	490	1415	1750	80	120	20	105	41		
	7	500	25 (1 ^B)	40 (1 1/2 ^B)	50 (2 ^B)	25 (1 ^B)	20 (3/4 ^B)	570	400	267.4	230	510	915	1250	100	150	20	115	37		
	7	750	25 (1 ^B)	40 (1 1/2 ^B)	50 (2 ^B)	25 (1 ^B)	20 (3/4 ^B)	570	400	267.4	230	510	1175	1510	100	150	20	130	50		
	7	1000	25 (1 ^B)	40 (1 1/2 ^B)	50 (2 ^B)	25 (1 ^B)	20 (3/4 ^B)	570	400	267.4	230	510	1440	1775	100	150	20	150	64		
	9	500	40 (1 1/2 ^B)	50 (2 ^B)	65 (2 1/2 ^B)	40 (1 1/2 ^B)	25 (1 ^B)	620	445	318.5	240	560	935	1290	100	150	20	150	54		
	9	750	40 (1 1/2 ^B)	50 (2 ^B)	65 (2 1/2 ^B)	40 (1 1/2 ^B)	25 (1 ^B)	620	445	318.5	240	560	1195	1550	100	150	20	175	73		
	9	1000	40 (1 1/2 ^B)	50 (2 ^B)	65 (2 1/2 ^B)	40 (1 1/2 ^B)	25 (1 ^B)	620	445	318.5	240	560	1460	1815	100	150	20	200	92		
	18	500	65 (2 1/2 ^B)	80 (3 ^B)	100 (4 ^B)	40 (1 1/2 ^B)	40 (1 1/2 ^B)	720	560	400	270	710	1045	1445	100	150	24	260	103		
	18	750	65 (2 1/2 ^B)	80 (3 ^B)	100 (4 ^B)	40 (1 1/2 ^B)	40 (1 1/2 ^B)	720	560	400	270	710	1305	1705	100	150	24	295	137		
	18	1000	65 (2 1/2 ^B)	80 (3 ^B)	100 (4 ^B)	40 (1 1/2 ^B)	40 (1 1/2 ^B)	720	560	400	270	710	1570	1970	100	150	24	340	171		
	22	500	65 (2 1/2 ^B)	80 (3 ^B)	100 (4 ^B)	40 (1 1/2 ^B)	40 (1 1/2 ^B)	760	620	450	270	720	1055	1455	100	150	24	330	131		
	22	750	65 (2 1/2 ^B)	80 (3 ^B)	100 (4 ^B)	40 (1 1/2 ^B)	40 (1 1/2 ^B)	760	620	450	270	720	1315	1715	100	150	24	380	173		
	22	1000	65 (2 1/2 ^B)	80 (3 ^B)	100 (4 ^B)	40 (1 1/2 ^B)	40 (1 1/2 ^B)	760	620	450	270	720	1580	1980	100	150	24	430	217		
	29	500	80 (3 ^B)	100 (4 ^B)	150 (6 ^B)	65 (2 1/2 ^B)	65 (2 1/2 ^B)	820	675	500	300	850	1120	1575	120	250	24	375	163		
	29	750	80 (3 ^B)	100 (4 ^B)	150 (6 ^B)	65 (2 1/2 ^B)	65 (2 1/2 ^B)	820	675	500	300	850	1380	1835	120	250	24	435	216		
	29	1000	80 (3 ^B)	100 (4 ^B)	150 (6 ^B)	65 (2 1/2 ^B)	65 (2 1/2 ^B)	820	675	500	300	850	1640	2095	120	250	24	495	269		
	34	750	80 (3 ^B)	100 (4 ^B)	150 (6 ^B)	65 (2 1/2 ^B)	65 (2 1/2 ^B)	870	745	550	300	860	1390	1945	120	250	24	560	262		
34	1000	80 (3 ^B)	100 (4 ^B)	150 (6 ^B)	65 (2 1/2 ^B)	65 (2 1/2 ^B)	870	745	550	300	860	1650	2105	120	250	24	635	326			
37	750	80 (3 ^B)	100 (4 ^B)	150 (6 ^B)	65 (2 1/2 ^B)	65 (2 1/2 ^B)	920	795	600	300	860	1410	1865	120	250	24	630	317			
37	1000	80 (3 ^B)	100 (4 ^B)	150 (6 ^B)	65 (2 1/2 ^B)	65 (2 1/2 ^B)	970	795	600	300	880	1670	2125	120	250	24	710	394			
53	750	80 (3 ^B)	100 (4 ^B)	150 (6 ^B)	65 (2 1/2 ^B)	65 (2 1/2 ^B)	970	845	650	300	890	1420	1880	120	250	24	735	373			
53	1000	80 (3 ^B)	100 (4 ^B)	150 (6 ^B)	65 (2 1/2 ^B)	65 (2 1/2 ^B)	970	845	650	300	890	1680	2140	120	250	24	830	462			
83	750	80 (3 ^B)	100 (4 ^B)	150 (6 ^B)	65 (2 1/2 ^B)	65 (2 1/2 ^B)	1120	1020	800	300	950	1485	1950	120	250	24	1180	597			
83	1000	80 (3 ^B)	100 (4 ^B)	150 (6 ^B)	65 (2 1/2 ^B)	65 (2 1/2 ^B)	1120	1020	800	300	950	1745	2210	120	250	24	1330	733			

Note) For the filter body diameter (øC), values of ø400 or higher indicate the inner diameter.

- FGD
- FGE
- FGG
- FGA**
- FGC
- FGF
- FGH
- FQ1
- FN

EB
ES

Industrial Filter

FGC Series

(Produced upon receipt of order)

How to Order

FGC **1** **C** **A** - **04** - **B** **002** **N**

Maximum operating pressure

Symbol	Maximum operating pressure
1	1 MPa
2	2 MPa
4	4 MPa

Wetted parts material (Vessel)

Symbol	Wetted parts material
C	SGP
S	Stainless steel 304

Element length

Symbol	Element length
A	L250
B	L500 (L250 x 2)

Port size

Symbol	Port size
04	15 (1/2 ^B)
06	20 (3/4 ^B)
10	25 (1 ^B)

Note) The connection method is flange connection, as indicated below.
 FGC1: JIS 10KFF flange connection
 FGC2: JPI300¹⁵RF flange connection
 FGC4: JPI600¹⁵RF flange connection

Element category

Symbol	Element type	Material
B	Sintered metal	Bronze
S		Stainless steel
T	Fiber	Polypropylene
G		Glass fiber
H		Cotton
P	Paper	Cotton
M	Micromesh	Stainless steel 316/Epoxy
L		Stainless steel 316



Element seal material ^{Note)}

Symbol	Element seal material
A	Non-asbestos
T	Fluororesin
N	NBR
V	FKM

Note) Refer to the below table for the element seal material types by the element category.

Nominal filtration accuracy (μm) ^{Note)}

Symbol	Nominal filtration accuracy (μm)
X50	0.5
001	1
002	2
005	5
010	10
020	20
040	40
050	50
070	70
074	74
075	75
100	100
105	105
120	120

Note) For a comparison with the nominal filtration accuracy according to the element category, refer to pages 41 and 42.

Element/Element Seal Material Combinations

Element material	Element seal material (Without seal)	Element seal material				
		Nil (Without seal)	Non-asbestos	PTFE	NBR	FKM
		A	T	N	V	
B	Bronze		○	○	○	
S	Stainless steel	○	○	○	○	
T	Polypropylene	○				
G	Glass fiber	○				
H	Cotton (Fiber)	○				
P	Cotton (Paper)			○	○	
M	Stainless steel 304/Epoxy			○	○	
L	Stainless steel 316		○	○	○	

● Various types of elements can be selected according to the “filtration conditions,” and the unit can be used for a wide range of applications.

● This type has a vertical structure, so there is little loss of “filtrate.”

● Maintenance — element replacement in particular is easy.

● This product is not certified by Japan’s High Pressure Gas Safety Act.

● Confirm the lead time with each order.

Note 1) The industrial filter/vessel series described in this catalog are products in which an element is incorporated into a vessel.

Note 2) To order only an element (replacement part), refer to “How to Order” on pages 41 and 42.

Note 3) When ordering only a vessel (replacement part), delete each symbol for “Element category”, “Nominal filtration accuracy (μm)” and “Element seal material” from the above “How to Order”.

Note 4) Please use industrial filters in combination with parts made by SMC (vessels, elements etc.)

Note 5) For the “FGCS” model, carbon steel is used and plated or coated with silver in locations except for wetted parts material.

Specifications

Standard Specifications

Model	FGC
Max. operating pressure (MPa)	1, 2, 4
Max. operating temperature (°C)	80
Port size	15 (1/2 ^B), 20 (3/4 ^B), 25 (1 ^B) <small>Note)</small>
Wetted parts material (Vessel)	SGP/Stainless steel 304
Gasket	Non-asbestos

Note 1) JIS10KFF (FGC1), JPI300^LRF (FGC2) and JPI600^LRF (FGC4) are used for this flange.

Note 2) The FGC1 can only be used with gas.

Applicable Element Specifications

Description	Material	Nominal filtration accuracy (μm)	Size
Sintered metal	Bronze	1, 2, 5, 10, 20, 40	ø65 x L250
	Stainless steel 316	70, 100, 120	ø65 x L500
Paper	Cotton (Phenol)	5, 10, 20	ø65 x L250 ø65 x L500
Fiber	Cotton	0.5, 1, 5, 10, 20	ø65 x L250
	Polypropylene	50, 75, 100	
	Glass fiber	1, 5, 10, 20	
Micromesh	Stainless steel 304	5, 10, 20, 40	ø65 x L250
	Stainless steel 316	74, 105	

FGD

FGE

FGG

FGA

FGC

FGF

FGH

FQ1

FN

EB

ES

Construction

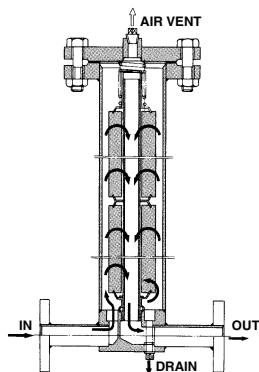

Element mounting figure

FGC Series

Dimensions

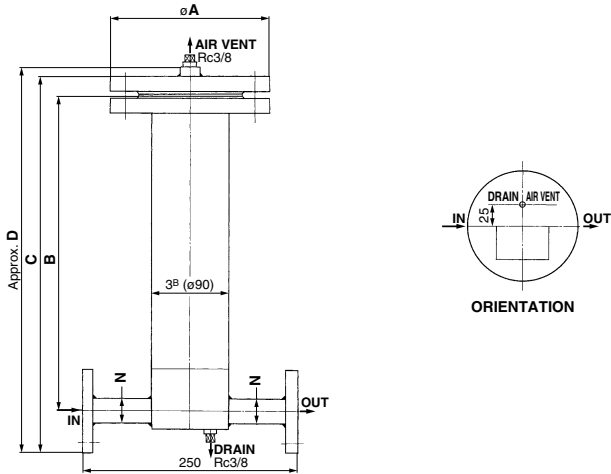

Standard Models

											(mm)
Model	Maximum operating pressure	Element length (L)	N (Port size)	ϕA	B	C	D	IN/OUT Flange standard	Weight (kg)	Internal volume (L)	
FGC1	1 MPa	250	15 (1/2 ^B)	185	380	447	467	JIS 10KFF	15	2	
			20 (3/4 ^B)	185	380	450	470		15		
			25 (1 ^B)	185	385	467	487		15		
		500	15 (1/2 ^B)	185	645	712	732		19	3	
			20 (3/4 ^B)	185	645	715	735		19		
			25 (1 ^B)	185	650	732	752		19		
FGC2	2 MPa	250	15 (1/2 ^B)	210	380	458	479	JPI 300 ^h SO,RF	23	2	
			20 (3/4 ^B)	210	380	474	490		23		
			25 (1 ^B)	210	385	477	499		23		
		500	15 (1/2 ^B)	210	645	723	744		27	3	
			20 (3/4 ^B)	210	645	734	755		27		
			25 (1 ^B)	210	650	742	764		27		
FGC4	4 MPa	250	15 (1/2 ^B)	210	375	465	488	JPI 600 ^h SO,RF	26	2	
			20 (3/4 ^B)	210	375	476	499		26		
			25 (1 ^B)	210	380	485	507		26		
		500	15 (1/2 ^B)	210	640	730	753		30	3	
			20 (3/4 ^B)	210	640	741	764		30		
			25 (1 ^B)	210	645	750	772		30		

Elements Sintered Metal/Fiber

Nonstandard elements of the FQ1 series can also be used commonly.
(For details, refer to Nonstandard Elements on page 84. Also, refer to page 3 for selection.)

Sintered Metal Filter Elements

- Outstanding mechanical strength, heat resistance and chemical resistance.
- Formed by sintering finely powdered metal, so a high filtration accuracy can be obtained.
- Even if clogging progresses, the element can be reused by cleaning.
- Main applications

Ideal as a check filter for keeping fluid clean.
All types of gases, fluids, general solvents and high-temperature fluids



Caution

The bronze element may be discolored by the moisture included in the atmosphere, but this does not affect the characteristics.

Specifications

Material	Bronze	Stainless steel 316	
Operating temperature (C°) ^{Note 2)}	0 to 150	0 to 150	
Nominal filtration accuracy (μm) ^{Note 3)}	1, 2, 5, 10, 20, 40, 70, 100, 120		
Max. differential pressure resistance	0.7 MPa		
Element replacement differential pressure	0.1 MPa		
Chemical resistance	Acid	Cannot be used.	Can be used. ^{Note 1)}
	Alkali	Cannot be used.	Can be used.
Element category of How to Order	B	S	

Note 1) Cannot be used with hydrochloric acid, hydrofluoric acid or phosphoric acid.

Note 2) Varies depending on the seal material used.

Note 3) The name is for distinguishing the raw material, and is different from the actual filtration rating.
(Refer to 11. Nominal filtration accuracy on page 118.)

How to Order Elements

E B 200 - 005 N

Element symbol

Element material

Symbol	Element material
B	Bronze
S	Stainless steel 316

Element size

Symbol	Element size
100	φ65 x L250
200	φ65 x L500
300	φ65 x L750
400	φ65 x L1000

Seal material/Operating temperature range

Symbol	Seal material	Operating temperature range (°C)
A ^{Note)}	Non-asbestos	0 to 150
T	Fluororesin	0 to 120
N	NBR	0 to 80
V	FKM	0 to 120

Note) Not possible with bronze elements.

Nominal filtration accuracy (μm)

Symbol	Nominal filtration accuracy (μm)
001	1
002	2
005	5
010	10
020	20
040	40
070	70
100	100
120	120

Fiber Elements

- Four types of materials with different characteristics are available so the filters are applicable to any application.
- Elements are economical because particle capturing capacity is excellent, and element life is long.
- Elements are disposable so maintenance and replacement are easy.
- Main applications

Cotton	Cleaning water, General neutral fluids, General solvents, Dry air
Polypropylene	Plating fluids, General acids, Alkali fluids, Industrial water, Cooling water
Glass fiber	Acid fluids, High-temperature fluids



Specifications

Material	Core material	Operating temperature (°C)	Nominal filtration accuracy (μm)	Differential pressure resistance (Max.)	Element replacement differential pressure
Cotton	Stainless steel 304	-20 to 100	0.5, 1, 5, 10, 20, 50, 75, 100	0.2 MPa	0.1 MPa
Polypropylene	Polypropylene	0 to 60	0.5, 1, 5, 10, 20, 50, 75, 100		
Glass fiber	Stainless steel 316	0 to 400	1, 5, 10, 20		

Note) Size for all is φ65 x L250. Different lengths are available as a special order up to 750 mm, only for cotton and polypropylene.

Elements Part No. List

Element material	Cotton	Polypropylene	Glass fiber	
Nominal filtration accuracy (μm)	Core material	Stainless steel 304	Polypropylene	Stainless steel 316
	0.5	EH10G	EHM10A	—
	1	EH39R10GV	EHM39R10AY	EHK27R10S
	5	EH23R10GV	EHM23R10AY	EHK19R10S
	10	EH19R10GV	EHM19R10AY	EHK15R10S
	20	EH15R10G	EHM15R10A	EHK10R10S
	50	EH11R10G	EHM11R10A	—
	75	EH10R10G	EHM10R10A	—
100	EH8R10G	EHM8R10A	—	
Element category of How to Order	H	T	G	

Note) Element seals are not used for fiber elements.

Standard Elements

Paper / Micromesh

Paper Elements

- Cartridges are pleated for a large filtration area, and elements are economical due to their long service life.

Main applications

Ideal for filtration of hydraulic oil, lubricating oil, fuel oil, oils for the liquid gas industry, dry inert gases, and dry air.

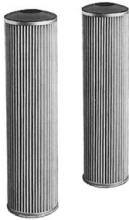

Specifications

Material	Filter paper (Cotton, Phenol resin impregnated paper)
Operating temperature (C°)	0 to 80
Nominal filtration accuracy (µm)	5, 10, 20
Max. differential pressure resistance	0.6 MPa
Joining material	Epoxy resin
Element replacement differential pressure	0.1 MPa
Element category of How to Order	P

How to Order Elements

EP 200 - 010 N

Paper element ●

Element size ●

Symbol	Element size
100	ø65 x L250
200	ø65 x L500
300	ø65 x L750
400	ø65 x L1000

Seal material ●

Symbol	Seal material
N	NBR
V	FKM

Nominal filtration accuracy (µm) ●

Symbol	Nominal filtration accuracy (µm)
005	5
010	10
020	20

Micromesh Elements

- Stainless steel metal mesh has high filtration accuracy.
- Outstanding heat and chemical resistance. Applicable to a wide range of applications.
- Pleated type has 3 times the filtration area of a cylinder.
- Filters are economical because they can be cleaned and repeatedly used.
- Main applications

Please use 40 microns or less as a high-precision filter, and 74 microns or higher as a high-grade strainer. All types of gases and fluids, high-temperature fluids.

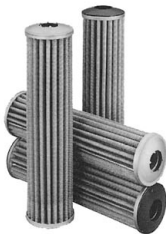

Specifications

Model	EM100	EM500
Materials	Stainless steel 304	Stainless steel 316
Joining material	Epoxy resin	—
Operating temperature (C°) ^{Note 2)}	0 to 100	0 to 150
Nominal filtration accuracy (µm)	5, 10, 20, 40, 74, 105	
Max. differential pressure resistance	0.7 MPa	
Element replacement differential pressure	0.1 MPa	
Chemical resistance	Acid	Cannot be used.
	Alkali	Can be used.
Element category of How to Order	M	L

Note 1) Cannot be used with hydrochloric acid, hydrofluoric acid or phosphoric acid.
 Note 2) Varies depending on the seal material used.

How to Order Elements

EM 500 - 074 A

Micromesh element ●

Group symbol ●

Symbol	Group symbol
100	Stainless steel 304
500	Stainless steel 316

Seal material/Operating temperature range ●

Symbol	Seal material	Operating temperature range (°C)
A ^{Note)}	Non-asbestos	0 to 150
T ^{Note)}	Fluororesin	0 to 120
N	NBR	0 to 80
V	FKM	0 to 120

Nominal filtration accuracy (µm) ●

Symbol	Nominal filtration accuracy (µm)
005	5
010	10
020	20
040	40
074	74
105	105

(Size ø65 x L250)

Note) Not possible with EM100 (Stainless steel 304)