

5.0 MPa Maximum Supply Pressure High Pressure Electro-Pneumatic Regulator

ITVX Series

⚠ Caution

This product is only for blowing gas. This product does not have sufficient pressure control for other applications (driving, sealing, etc.).



Stepless control of air pressure proportional to an electrical signal

Maximum supply pressure: **5.0 MPa**

Set pressure range: **0.01 to 3.0 MPa**

Maximum flow rate: **3000 L/min [ANR]**

*Supply pressure: 5.0 MPa Set pressure: 3.0 MPa

Fluid: **Air, N₂, O₂, Ar**

* When using O₂, refer to "Fluid Supply" on page 967.

Wetted parts: **Fluorine grease**

Power consumption

3 W or less

Digital pressure display



Application example

Laser beam machine

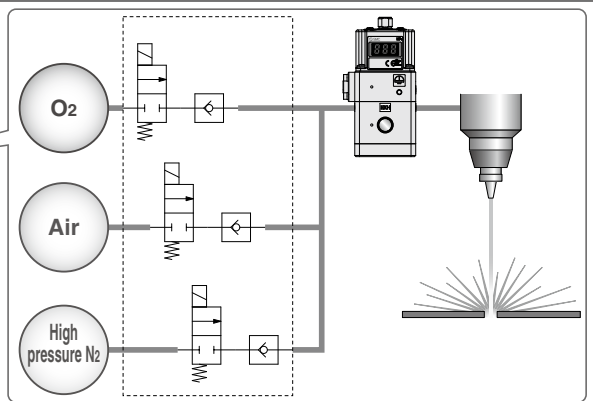
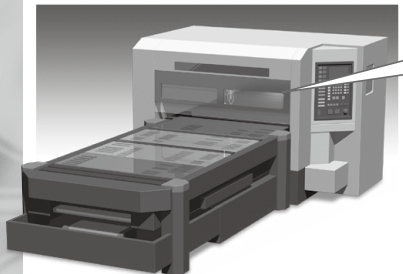

5.0 MPa Maximum Supply Pressure

High Pressure Electro-Pneumatic Regulator



ITVX2000 Series

How to Order

ITVX2030-013S

Body size

2	ITVX2000
---	----------

Pilot type

0	Built-in regulator type <small>Note)</small>
---	--

Note) For details, refer to page 1250 "Working Principle."

Set pressure range

3	0.01 to 3.0 MPa
---	-----------------

Power supply voltage

0	24 VDC
---	--------

Input signal

0	Current type 4 to 20 mA DC (Sink type)
1	Current type 0 to 20 mA DC (Sink type)
2	Voltage type 0 to 5 VDC
3	Voltage type 0 to 10 VDC

Monitor output

1	Analog output 1 to 5 VDC
2	Switch output/NPN output
3	Switch output/PNP output
4	Analog output 4 to 20 mA DC (Sink type)

Thread type

NII	Rc
N	NPT
F	G <small>Note)</small>

Note) Complies with ISO1179-1 (2007).

Port size

3	3/8 <small>Note)</small>
---	--------------------------



Note) The exhaust port size is 1/4". The exhaust port size for the built-in regulator and the solenoid valve is M5.

Pressure display unit



NII	MPa
2 <small>Note)</small>	kgf/cm ²
3	bar
4 <small>Note)</small>	psi

Note) Under Japan's new Measurement Act, this is only for overseas sales (SI units are to be used inside Japan).

Cable connector type

	Straight type 3 m
S	
	Right angle type 3 m
L	
N	Without cable connector

Bracket

NII	Without bracket
	Flat bracket
B	
	L-bracket
C	

Standard Specifications



Symbol

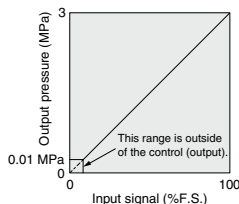
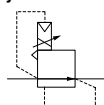

Fig. 2. Input/output characteristics chart

Model		ITVX2000
Minimum supply pressure		Whichever is higher: 0.5 MPa or the set pressure +0.2 MPa
Maximum supply pressure		5 MPa ^{Note 2)}
Set pressure range ^{Note 3)}		0.01 to 3.0 MPa
Power supply	Voltage	24 VDC $\pm 10\%$
	Current consumption	0.12 A or less
Input signal	Current type ^{Note 4)}	4 to 20 mA DC, 0 to 20 mA DC (Sink type)
	Voltage type	0 to 5 VDC, 0 to 10 VDC
Input impedance	Current type	500 Ω or less
	Voltage type	6 to 6.5 k Ω (at ordinary temperature)
Output signal (Monitor output) ^{Note 5)}	Analog output	1 to 5 VDC (Output impedance: Approx. 1 k Ω) Output accuracy: $\pm 6\%$ or less (Full span)
		4 to 20 mA DC (Sink type) Load impedance: 250 Ω or less Output accuracy: $\pm 6\%$ or less (Full span)
	Switch output	NPN open collector output: Max. 30 V, 80 mA Hysteresis: $\pm 3\%$ (Full span), Self-diagnosis: $\pm 5\%$ or less (Full span)
		PNP open collector output: Max. 80 mA Hysteresis: $\pm 3\%$ (Full span), Self-diagnosis: $\pm 5\%$ or less (Full span)
Linearity		$\pm 1\%$ or less (Full span)
Hysteresis		1% or less (Full span)
Repeatability		$\pm 1\%$ or less (Full span)
Sensitivity		$\pm 1\%$ or less (Full span)
Temperature characteristics		$\pm 0.12\%$ or less (Full span)/ $^{\circ}\text{C}$
Output pressure display	Accuracy	$\pm 2\%$ or less (Full span) ± 1 digit
	Minimum unit ^{Note 6)}	MPa: 0.01, kgf/cm 2 : 0.1, bar: 0.1, psi: 1
Fluid		Air, N $_2$, O $_2$, Ar
Ambient and fluid temperature		0 to 50 $^{\circ}\text{C}$ (No condensation)
Weight		Approx. 570 g (without options)

Note 1) Characteristics shown above are based on the piping conditions of Fig. 1.

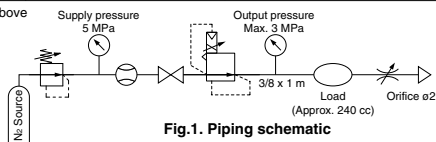

Fig. 1. Piping schematic

Note 2) When oxygen is used as a fluid, the maximum supply pressure must be less than 1 MPa.

Note 3) Refer to Fig. 2 for the relationship between set pressure and input signal.

Note 4) 2-wire type 4 to 20 mA DC is not available. Power supply voltage 24 VDC is required.

Note 5) Select either analog output or switch output. Further, when switch output is selected, select either NPN output or PNP output. When measuring analog output of 1 to 5 VDC with a load impedance less than 100 k Ω , the analog output may not obtain the output accuracy of $\pm 6\%$ or less (F.S.).

Note 6) Adjustment of numerical values such as the zero/span adjustment is set based on the minimum units for output pressure display. Note that the unit cannot be changed.

Note 7) This product is only for blowing gas. This product does not have sufficient pressure control for applications other than blowing (driving, sealing, etc.).

Note 8) This product is not certified by Japan's High Pressure Gas Safety Act.

Fluid Supply

⚠ Warning

1. Compressed air, nitrogen, oxygen or argon can be used as a fluid.
2. Do not use compressed air which includes chemicals, synthetic oils containing organic solvents, salt, or corrosive gases, etc., as this can cause damage or malfunction.
3. If oxygen is used as the fluid, it can lead to serious and unforeseen risks. However, it is possible to manage and control the risk of hazards and economic loss. In order to use the product safely, it should only be handled by personnel with appropriate knowledge, with support from a suitably qualified specialist.
4. Oxygen gas increases the susceptibility of substances to burning; Oxygen gas can be ignited by frictional heat and

static electricity. If oxygen is ignited, the metal and seal materials burn. Therefore, flush the piping thoroughly and mount a suitable filter to prevent foreign matter such as metal powder and dust from entering the product.

5. Take safety measures by installing safety devices (e.g. a circuit that stops the supply of oxygen gas) to prevent fire and explosion in the event of failure, taking flameproof safety standards into consideration.
6. Since there are three exhaust ports on the product, connect the piping in order to exhaust oxygen. Do not block the exhaust port.

Wiring

⚠ Caution

F.G. (Grounding)

Ground the frame ground (F.G.) terminal at the front of the main body. If the F.G. terminal port is not used, this product may not operate properly due to the noise.

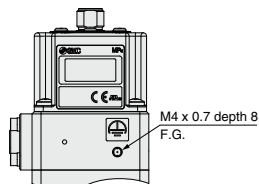

ITVX2000 Series

Accessories (Option)/Part No.

Description		Part no.
Flat bracket assembly (including mounting screws)		P398020-600
L-bracket assembly (including mounting screws)		P398020-601
Power cable connector	Straight type 3 m	P398020-500-3
	Right angle type 3 m	P398020-501-3

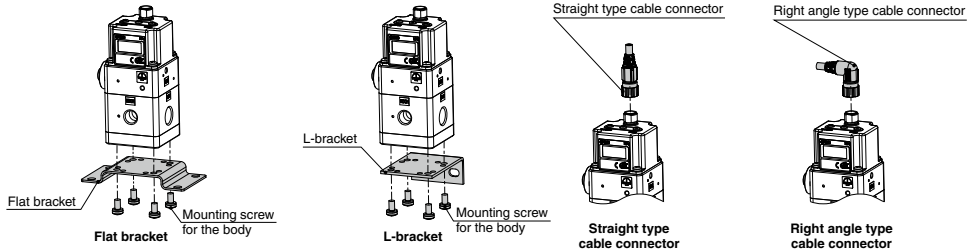

Dimensions

Flat bracket

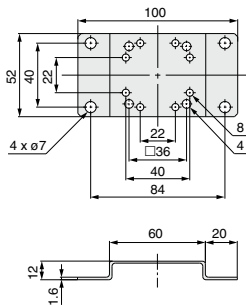

L-bracket

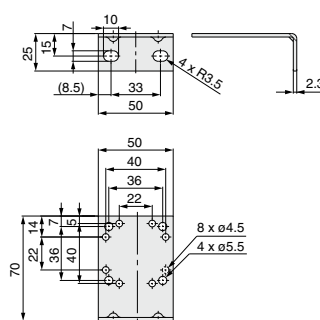

Working Principle

When the input signal rises, the **air supply solenoid valve** ① turns ON, and the **exhaust solenoid valve** ② turns OFF. Therefore, supply pressure regulated by a **built-in regulator** ③ passes through the **air supply solenoid valve** ① and is applied to the **pilot chamber** ④. The pressure in the **pilot chamber** ④ increases and operates on the upper surface of the **diaphragm** ⑤.

As a result, the **air supply valve** ⑥ linked to the **diaphragm** ⑤ opens, and a portion of the supply pressure becomes output pressure.

This output pressure feeds back to the **control circuit** ⑧ via the **pressure sensor** ⑦. Here, a correct operation functions until the output pressure is proportional to the input signal, making it possible to always obtain output pressure proportional to the input signal.

Working Principle Diagram

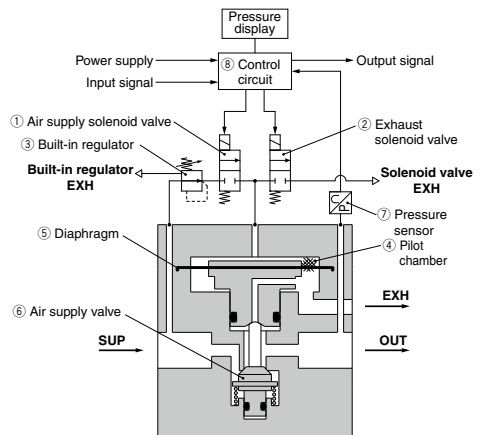

ITVX2000 Series

Linearity

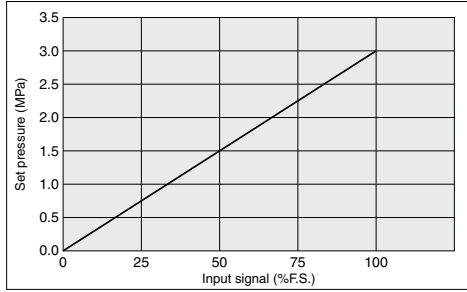

Hysteresis

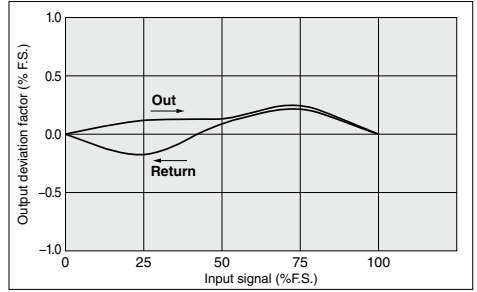

Repeatability

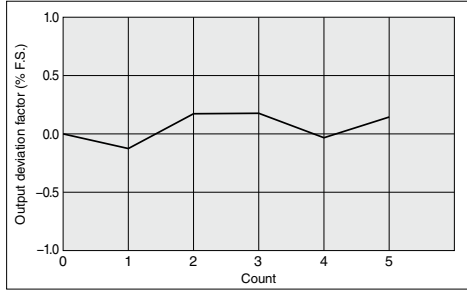

Pressure Characteristics

Set pressure: 0.4 MPa

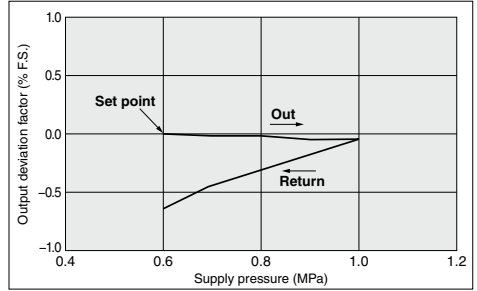

Flow Rate Characteristics

Supply pressure: 1.0 MPa

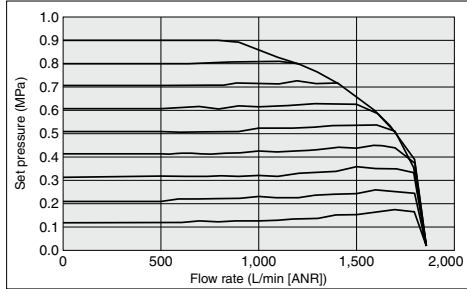

ITVX2000 Series

Dimensions

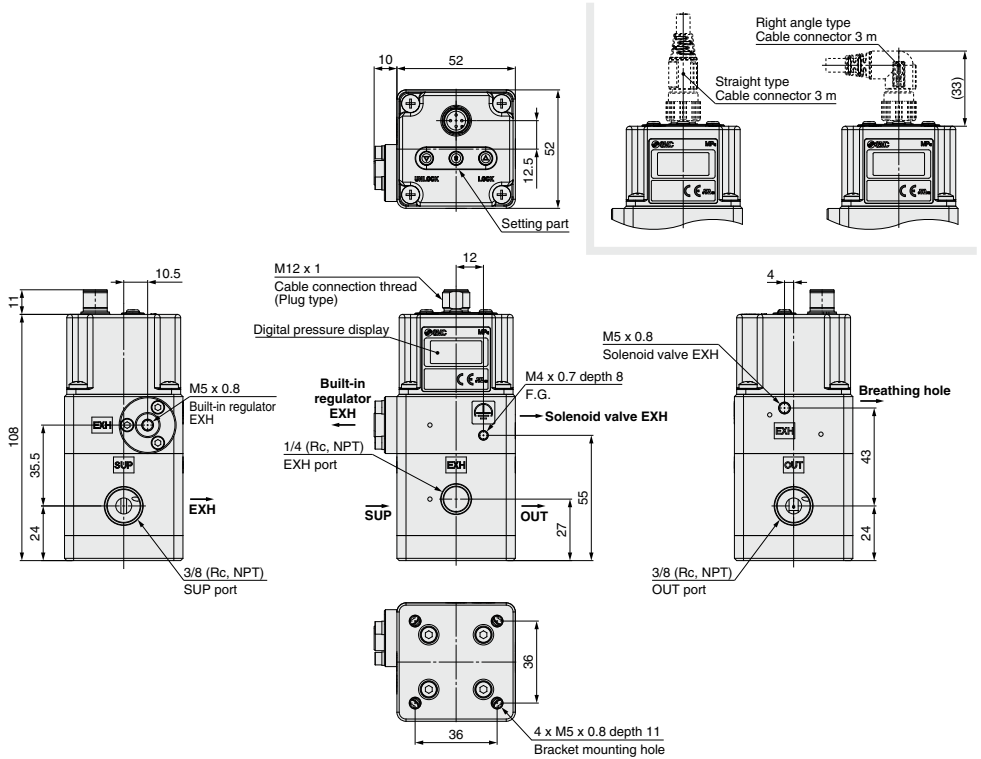

With flat bracket

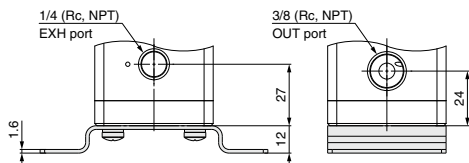
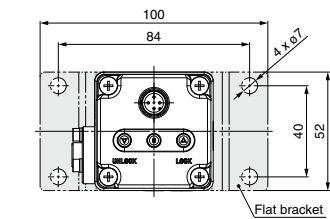

G thread

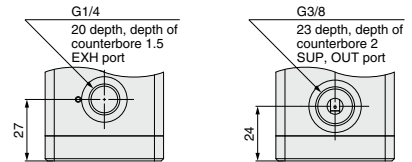

With L-bracket

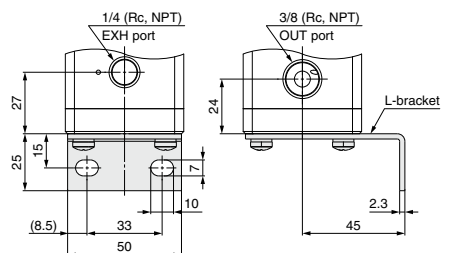



ITVX2000 Series

Specific Product Precautions 1

Be sure to read this before handling the products. Refer to page 9 for safety instructions and pages 13 to 17 for common precautions.

Piping

⚠ Warning

1. Screw piping together with the recommended proper torque while holding the side with the female threads.

Looseness or faulty sealing will occur if tightening torque is insufficient, while thread damage will result if the torque is excessive. Furthermore, if the side with the female threads is not held while tightening, excessive force will be applied directly to piping brackets etc., causing damage or other problems.

Connection thread	Recommended proper torque: N·m
M5	1.5 to 2
1/4	8 to 12
3/8	15 to 20

2. Do not allow twisting or bending moment to be applied other than the weight of the equipment.

Provide separate support for external piping, as damage may otherwise occur.

3. Since excessive moment loads and the propagation of vibrations, etc. can easily result from inflexible piping made of materials such as steel, avoid these problems by using flexible tubing for intermediate connections.

⚠ Caution

1. Preparation before piping

Before piping is connected, it should be thoroughly blown out with air (flushing) or washed to remove chips, cutting oil and other debris from inside the pipe.

2. Winding of sealant tape

When screwing together pipes and fittings, etc., be certain that chips from the pipe threads and sealing material do not get inside the piping.

Also, when sealant tape is used, leave 1.5 to 2 thread ridges exposed at the end of the threads.

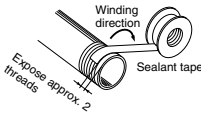

Operating Environment

⚠ Warning

1. Do not operate in locations having an atmosphere of corrosive gases, chemicals, sea water, or where there will be contact with the same.

⚠ Caution

1. In locations where the body is exposed to water, steam, dust, etc., there is a possibility that moisture or dust could enter the body through the EXH port, solenoid valve EXH port and/or built-in regulator EXH port, thereby causing problems.

Operating Environment

⚠ Caution

2. Do not operate in locations where vibration or impact occurs.
3. In locations which receive direct sunlight, provide a protective cover etc.
4. In locations near heat sources, block off any radiated heat.
5. Employ suitable protective measures in locations where there is contact with water droplets, oil or welding spatter, etc.

Fluid Supply

⚠ Warning

1. Compressed air, nitrogen, oxygen or argon can be used as a fluid.
2. Do not use compressed air which includes chemicals, synthetic oils containing organic solvents, salt, or corrosive gases, etc., as this can cause damage or malfunction.
3. If oxygen is used as the fluid, it can lead to serious and unforeseen risks. However, it is possible to manage and control the risk of hazards and economic loss. In order to use the product safely, it should only be handled by personnel with appropriate knowledge, with support from a suitably qualified specialist.
4. Oxygen gas increases the susceptibility of substances to burning; Oxygen gas can be ignited by frictional heat and static electricity. If oxygen is ignited, the metal and seal materials burn. Therefore, flush the piping thoroughly and mount a suitable filter to prevent foreign matter such as metal powder and dust from entering the product.
5. Take safety measures by installing safety devices (e.g. a circuit that stops the supply of oxygen gas) to prevent fire and explosion in the event of failure, taking flameproof safety standards into consideration.
6. Since there are three exhaust ports on the product, connect the piping in order to exhaust oxygen. Do not block the exhaust port.

⚠ Caution

1. This product does not have a filtering function. Install an air filter on the supply side close to the product. Select an air filter with a filtration degree of 5 µm or finer.
2. Compressed air containing large amounts of drainage can cause a malfunction of this product and other pneumatic equipment. As a countermeasure, install an aftercooler, air dryer or water droplet separator, etc.
3. If large amounts of carbon dust are generated by the compressor, it can accumulate inside this product and cause a malfunction.

For details on the above compressed air quality, refer to pages 20 and 21 "Air Preparation Equipment Model Selection Guide."



ITVX2000 Series

Specific Product Precautions 2

Be sure to read this before handling the products. Refer to page 9 for safety instructions and pages 13 to 17 for common precautions.

Handling

⚠ Caution

1. Do not use a lubricator on the supply side of this product, as this can cause a malfunction.
2. If electric power is shut off due to a power failure or any reason while the product is being controlled, air supply at the set pressure will be continuously consumed.
3. If supply pressure to this product is interrupted while the power is still on, the internal solenoid valve will continue to operate and a humming noise may be generated. Since the life of the product may be shortened, shut off the power supply also when supply pressure is shut off.
4. Do not block three EXH ports on this product.
5. This product does not have a shut-off valve function. If air pressure is supplied without electric power being applied, output pressure may increase to the pressure equivalent of the supply pressure. Due to product construction, a very small amount of air is discharged from the exhaust port when output pressure is generated. Operate the system to shut off the supply pressure when not operating the product.
6. The product is adjusted to each specification at the time of shipment from the factory. Do not perform unnecessary disassembly or removal of parts as it will cause failure.
7. The optional cable connector is a 4-core wire type. When the monitor output (analog output or switch output) is not being used, keep it from touching the other wires as this can cause a malfunction.
8. Please note that the right angle cable does not rotate and is limited to only one entry direction.
9. Take the following steps to avoid a malfunction due to noise.
 - 1) Remove power supply noise during operation by installing a line filter, etc. in the AC power line.
 - 2) For avoiding the influence of noise or static electricity, install this product and its wiring as far as possible from strong electric fields such as those of motors and power lines, etc.
 - 3) Be sure to implement protective measures against load surge for induction loads (solenoid valves, relays, etc.).
10. For details on the handling of this product, refer to the operation manual which is included with the product.

Design/Selection

⚠ Caution

1. The direct-current power supply to combine should be UL authorized power supply.

1) Limited voltage current circuit in accordance with UL508.
A circuit in which power is supplied by the secondary coil of a transformer that meets the following conditions.

- Maximum voltage (with no load):
30 [Vrms] (42.4 [V peak]) or less
- Maximum current:
 1. 8 [A] or less (including when short circuited)
 2. Limited by circuit protector (such as fuse) with the following ratings

No load voltage [V peak]	Max. current rating [A]
0 to 20 [V]	5.0
Over 20 [V] to 30 [V]	100 Peak voltage

2) A circuit using max. 30 [Vrms] or less (42.4 [V peak]), which is powered by UL1310 or UL1585 compatible Class-2 power supply.

2. Operate these products only within the specified voltage.

Using voltages beyond the specified levels could cause faults or malfunctions.

3. Use 0 V as the baseline for the power supplied to this product for output, control and input.

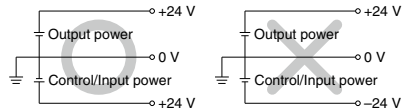

4. Each product needs to be powered by one power supply unit.

The wiring of this product has the same common between the GND for power and the signals; there is a possibility that a wrong current occurs and prevents a proper operation if one power supply unit controls multiple electro-pneumatic regulators.



ITVX2000 Series

Specific Product Precautions 3

Be sure to read this before handling the products. Refer to page 9 for safety instructions and pages 13 to 17 for common precautions.

Wiring

⚠ Caution

Connect the cable to the connector on the body with the wiring arranged as shown below. Proceed carefully, as incorrect wiring can cause damage. Further, use DC power with sufficient capacity and a low ripple.

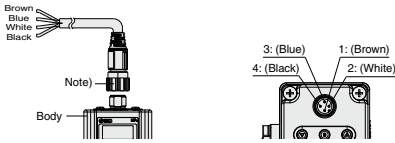

Note) The cable is also available in a right angle type. A right angle type connector is attached facing left (toward the SUP port). Do not attempt to rotate, as the connector does not turn.

Current Signal Type Voltage Signal Type

1	Brown	Power supply
2	White	Input signal
3	Blue	GND (COMMON)
4	Black	Monitor output

Wiring diagram

Current signal type

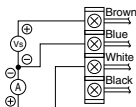

Vs : Power supply 24 VDC
 A : Input signal 4 to 20 mA DC
 0 to 20 mA DC

Voltage signal type

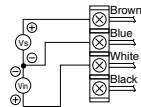

Vs : Power supply 24 VDC
 Vin: Input signal 0 to 5 VDC
 0 to 10 VDC

F.G. (Grounding)

Ground the frame ground (F.G.) terminal at the front of the main body. If the F.G. terminal port is not used, this product may not operate properly due to the noise.

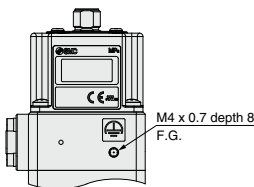

Wiring

⚠ Caution

Monitor output wiring diagram

Analog output: Voltage type

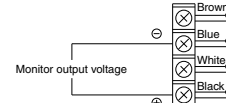

Analog output: Current type (Sink type)

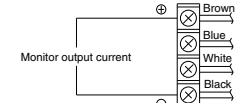

Switch output: NPN type

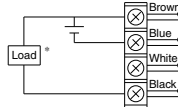

Switch output: PNP type

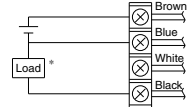

* When 80 mA DC or more is applied, detecting device for overcurrent starts activating and then emits an error signal. (Error number "5")

Return of Product

⚠ Warning

If the product to be returned is contaminated or is possibly contaminated with substances that are harmful to humans, for safety reasons, please contact SMC beforehand and then employ a specialist cleaning company to decontaminate the product. After the decontamination prescribed above has been carried out, submit a Product Return Request Sheet or the Detoxification/Decontamination Certificate to SMC and await SMC's approval and further instructions before attempting to return the item.

Please refer to the International Chemical Safety Cards (ICSC) for a list of harmful substances.

If you have any further questions, please don't hesitate to contact your SMC sales representative.