

Miniature Fittings



M Series

Applicable Tubing: $\phi 2$ Connection Thread: M3, M5



Made to Order
(Refer to page 193 for details.)

Applicable tubing O.D. x I.D.: $\phi 2 \times \phi 1.2$
 Connection thread: M3 x 0.5 / M5 x 0.8
 One-touch fitting size: $\phi 3.2 / \phi 4$



Tubing Connection and Removal

Connection of tubing

1. Cut the tubing perpendicularly allowing additional length.
2. Insert the tubing into the sleeve.

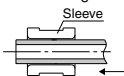

3. Insert the tubing slowly into the fittings. Make sure to secure a gap of approx. 0.5 mm between the tubing end and the barb end.

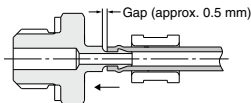

4. Insert the sleeve slowly. Make sure not to allow any gap between the sleeve end side and the body end side. (Please refer to the illustration below.)

If you feel any strong resistance and cannot push the sleeve completely to the end side, this may be caused due to jamming. Remove and repeat again by starting from step 1 making sure to secure a gap in the step 3.

Note) When installing the tubing, the sleeve must be attached. Operation without attaching the sleeve may cause tubing disconnection.

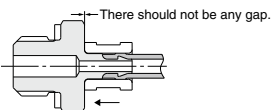

Removal of tubing

1. Withdraw the sleeve straight along the tubing. Use a tool such as long-nose pliers if it is difficult to pull out by hand.
2. Withdraw the tubing straight.
3. When reusing the tubing, cut off the previously installed portion of the tubing to avoid possible leakage and/or disconnection of the tubing.

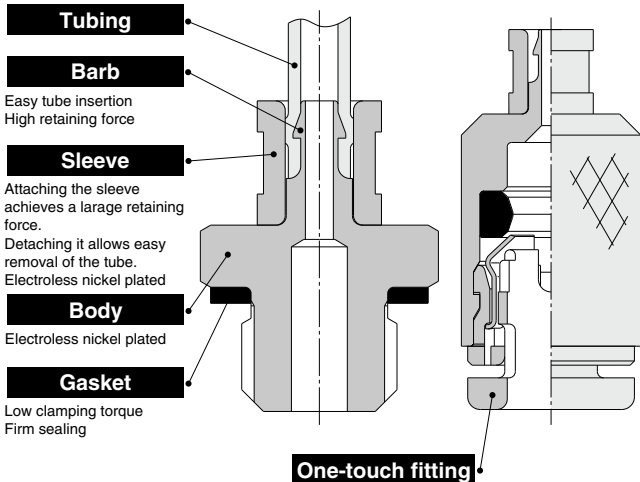

Specifications

Applicable tubing material	Polyurethane
Applicable tubing (O.D. / I.D.)	$\phi 2 / \phi 1.2$
Fluid	Air, N ₂ , Water (1, 2, 3)
Max. operating pressure	1 MPa (4)
Ambient and fluid temperature	-5 to 60°C, Water: 0 to 40°C (No freezing)
Port size	M3, M5, $\phi 3.2$, $\phi 4$
Thread	JIS B0205 (Metric fine thread)

- Note 1) The surge voltage pressure must be under the maximum operating pressure.
 Note 2) Deionized water is not recommended for use as it may affect the material used in the fittings. In addition, it is known to degrade the water quality.
 Note 3) As the barb One-touch comes with grease, it cannot be used when N₂ is used as clean, dry air.
 Note 4) Apply the maximum operating pressure to the tube during the tube connection.

How to Order

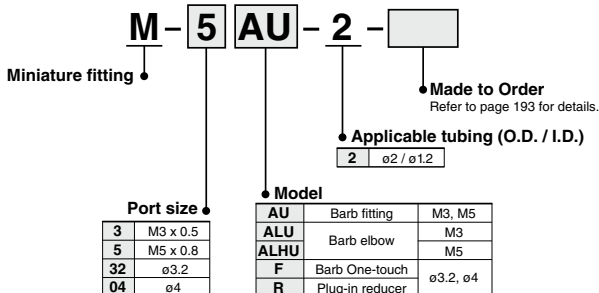

For details on applicable tubing O.D. and port size combinations for each model, refer to the charts on the Dimensions page.

- KQ2
- KQB2
- KS
- KX
- KM
- KF
- M
- H/DL
- L/LL
- KC
- KK
- KK130
- DM
- KDM
- KB
- KR
- KA
- KQG2
- KG
- KFG2
- MS
- KKA
- KP
- LQ
- MQR
- T
- IDK

M Series

Dimensions

Barb Fitting: M-3AU-2, M-5AU-2



Applicable tubing O.D. / I.D. (mm)	Connection thread	Model	H	A	B	C	D	E	F	M	Weight (g)
ø2 / ø1.2	M3 x 0.5	M-3AU-2	4.5	9	3	4	5	4	0.9	2.5	0.7
	M5 x 0.8	M-5AU-2	7	10	4	4	7.7	4	0.9	2.5	1.5

Component Parts

No.	Description	Material	Note
1	Sleeve	C3604	Electroless nickel plated
2	Barb fitting	C3604	Electroless nickel plated
3	Gasket	NBR, Stainless steel 304	—

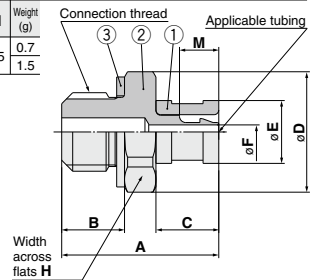

Barb Elbow: M-3ALU-2, M-5ALHU-2



Applicable tubing O.D. / I.D. (mm)	Connection thread	Model	H	A	B	C	D	E	F	G	I	J	M	Weight (g)
ø2 / ø1.2	M3 x 0.5	M-3ALU-2	5	9	6.5	4	4	0.9	2.5	2.5	9.4	5	2.5	1.6
	M5 x 0.8	M-5ALHU-2	7	11	7.5	4	4	0.9	3.5	3.5	13.5	7	2.5	3.5

Component Parts

No.	Description	Material	Note
1	Sleeve	C3604	Electroless nickel plated
2	Stud	C3604	Electroless nickel plated
3	Barb elbow	C3604	Electroless nickel plated
4	Gasket	NBR, Stainless steel 304	—

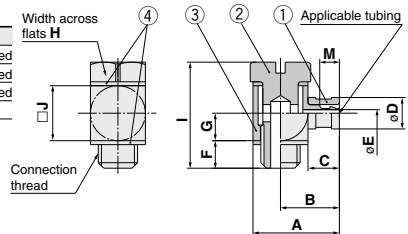

Barb One-touch: M-32F-2, M-04F-2



Applicable tubing (mm) a) (O.D./I.D.) b) (O.D.)	Model	A	B	C	D	E	M1	M2	Weight (g)	
		ø2 / ø1.2	ø3.2	M-32F-2	17.7	13.7	7.5	4	0.9	12.7
	ø4	M-04F-2	18	14	8.5	4	0.9	12.7	2.5	2.9

Component Parts

No.	Description	Material	Note
1	Sleeve	C3604	Electroless nickel plated
2	Body	C3604	Electroless nickel plated
3	Seal	NBR	—
4	Cassette	POM, Stainless steel 304	—

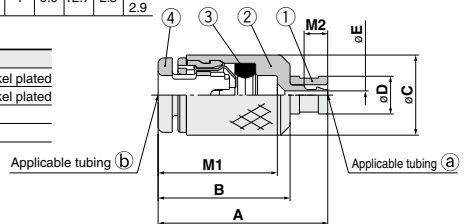

Plug-in Reducer: M-32R-2, M-04R-2

Applicable tubing O.D. / I.D. (mm)	Fitting size øD	Model	A	B ⁽¹⁾	B ⁽²⁾	C	E	F	M	Weight (g)
ø2 / ø1.2	ø3.2	M-32R-2	36	23.3	20.5	31.5	0.9	4	2.5	0.8
	ø4	M-04R-2	36.5	23.8	20.5	32	0.9	4	2.5	0.7

Note 1) Dimensions when connected to the M5 and M6 connection threads for KJ series and KQ series.

Note 2) Dimensions when connected to KQ series.

Component Parts

No.	Description	Material	Note
1	Sleeve	C3604	Electroless nickel plated
2	Studded body	C3604	Electroless nickel plated
3	Stem	PP	—

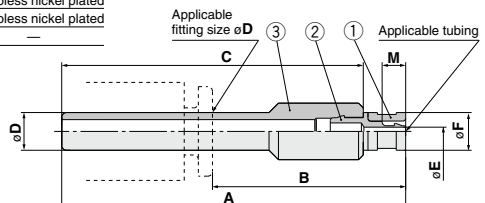



1 Gasket Material Modification

Symbol	Specifications	
X226	Gasket material: Stainless steel 304, FKM	
	Applicable thread	Gasket part no.
	M3	M3G-DPH00489
X112	Gasket material: Stainless steel 316, Special FKM	
	Applicable thread	Gasket part no.
	M5	M-5G3

Spare Parts

Description	Part no.	Applicable thread	Material	Applicable model
Gasket	M-3G	M3	PVC	—
	M-3G3		Stainless steel 304, NBR	M-3AU-2, M-3ALU-2
	M-5G2	M5	Stainless steel 304, NBR	M-5AU-2, M-5ALHU-2
	M-5G3		Stainless steel 316, Special FKM	—
Sleeve	M-5-2-P02	—	C3604 (With electroless nickel plated)	M-□-2

⚠ Specific Product Precautions

Be sure to read this before handling the products.
Refer to back page 50 for Safety Instructions and pages 13 to 17 for Fittings and Tubing Precautions.

⚠ Caution

1. Tightening of M3/M5 Threads

Tighten by hand, and give it an additional turn with a wrench.

Please check the number of tightening revolutions using the table below.

If tightened excessively, thread portion may be damaged and gasket may be deformed. This will cause air leakage.

On the contrary, if tightened insufficiently, thread may loosen causing air leakage.

Thread	Model	Number of tightening rotations
M3	M-3AU-2	Approx. 1/4 rotations
	M-3ALU-2	Approx. 1/2 rotations
M5	M-5AU-2	Approx. 1/6 to 1/4 rotations ^(Note)
	M-5ALHU-2	Approx. 1/2 rotations ^(Note)

(Note) As a guideline, the tightening torque should be 1 to 1.5 N·m.

KQ2

KQB2

KS
KX

KM

KF

M

H/DL
L/LL

KC

KK

KK130

DM

KDM

KB

KR

KA

KQG2

KG

KFG2

MS

KKA

KP

LQ

MQR

T

IDK

Miniature Fittings

M Series

Applicable Tubing: $\varnothing 3.2, \varnothing 4, \varnothing 6$ Connection Thread: M3, M5, R $\frac{1}{8}$

RoHS

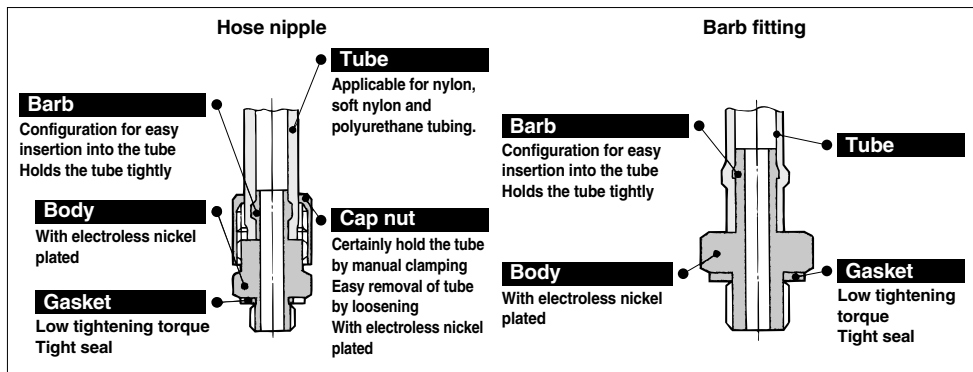

Compact piping space

Hose nipple tubing connection/disconnection is simple while keeping a large retaining force.

Line up various types

For air connection in confined areas.

Accepts many types of plastic tubing

Hose nipple and hose elbow accepts nylon, soft nylon, and polyurethane tubing.



Made to Order

(Refer to page 200 for details.)

Specifications

Applicable tubing material		Nylon	Soft nylon	Polyurethane	PFA ⁽¹⁾	FEP ⁽²⁾	Modified PTFE ⁽³⁾	Wear resistant polyurethane ⁽⁴⁾		
Applicable tubing O.D./I.D.	M3	—	$\varnothing 3.18/\varnothing 2.18$	$\varnothing 3.18/\varnothing 2.5$	—	—	—	—		
	M5, R $\frac{1}{8}$	$\varnothing 4/\varnothing 2.5$ $\varnothing 6/\varnothing 4$		$\varnothing 4/\varnothing 2.5$ $\varnothing 6/\varnothing 4$	$\varnothing 3.18/\varnothing 2$ $\varnothing 4/\varnothing 2.5$ $\varnothing 6/\varnothing 4$	$\varnothing 4/\varnothing 2.5$ $\varnothing 6/\varnothing 4$	$\varnothing 4/\varnothing 2.5$ $\varnothing 6/\varnothing 4$	$\varnothing 4/\varnothing 2.5$ $\varnothing 6/\varnothing 4$	$\varnothing 4/\varnothing 2.5$ $\varnothing 6/\varnothing 4$	
Fluid				Air, N ₂ , Water ^(5, 6, 7)						
Max. operating pressure (at 20°C)				1.5 MPa	1 MPa	0.8 MPa	1 MPa	1.5 MPa	1.4 MPa	0.8 MPa
Ambient and fluid temperature				-5 to 60°C, Water: 0 to 40°C (No freezing)						
Connection size				M3, M5, R $\frac{1}{8}$			M5, R $\frac{1}{8}$			
Thread				JIS B0205, Class 2 (Metric fine thread) JIS B0203 (Taper thread for piping)						

Note 1), Note 2), Note 3), Note 4) Compatible only with hose nipple type.

Note 5) Barb fitting, barb elbow, barb elbow (H) are not compatible with water.

Note 6) Deionized water is not recommended for use as it may affect the material used in the fittings.

In addition, it is known to degrade the water quality.

Note 7) As the universal nipple comes with grease, it cannot be used when N₂ is used as clean, dry air.

Principal Parts Material

Material	Body	C3604 (Electroless nickel plate) (Nipple M-3N, M-5N: Stainless steel 303)
	Gasket	Nylon 66: GF30%, Stainless steel 304: NBR

* Body of M-5E, M-5ER, M-5M is not surface-treated.

Electroless nickel plate treated is available as option -X2.









Fitting Markings for Applicable Tubing Material (Barb fitting, Barb elbow, Barb elbow (H))







Tubing material determines the compatible fittings. (Refer to the table below.)























Connection	Tubing	Fitting marking for applicable tubing material		
		Barb fittings	Barb elbow	Barb elbow (H)
M3	Soft nylon tubing Polyurethane tubing		—	
	Nylon tubing			
R $\frac{1}{8}$, M5	Soft nylon tubing Polyurethane tubing	Marking	Marking	Marking











M3, R 1/8 Series

M5 Series

Series	Model	Description	Application	Note
M3	M-3AU-3	Barb fitting for soft tube 	For soft nylon tubing For polyurethane tubing	ø3.18/2.18 x M3 ø3.18/2 x M3
	M-3AU-4	 P.196	For soft nylon and polyurethane tubing	ø4/2.5 x M3
	M-3ALU-3	Barb elbow for soft tubing 	For soft nylon tubing Body rotates at 360° around the stud axis For polyurethane tubing	ø3.18/2.18 x M3 ø3.18/2 x M3
	M-3ALU-4	 P.196	For soft nylon and polyurethane tubing	ø4/2.5 x M3
	M-3UL	Universal elbow  P.196	Body rotates at 360° around the stud axis	M3 female x M3 male
	M-3UT	Universal tee  P.196	Body rotates at 360° around the stud axis	M3 female x M3 female x M3 male
	M-3N	Nipple  P.196	Fitting to workpiece and fitting to fitting connection	M3 male x M3 male
	M-3P	Plug  P.196	Use to plug unused M3 port	

Series	Model	Description	Application	Note
R 1/8	M-01AN-4	Barb fitting for nylon tubing 	For nylon tubing	ø4/2.5 x R 1/8
	M-01AN-6	 P.196		ø6/4 x R 1/8
	M-01AU-4	Barb fitting for soft tubing 	For soft nylon and polyurethane tubing	ø4/2.5 x R 1/8
	M-01AU-6	 P.196		ø6/4 x R 1/8
	M-01H-4	Hose nipple 	For nylon, soft nylon and polyurethane tubing	ø4/2.5 x R 1/8
	M-01H-6	 P.196		ø6/4 x R 1/8

Series	Model	Description	Application	Note
M5	M-5AN-4	Barb fitting for nylon tubing 	For nylon tubing	ø4/2.5 x M5
	M-5AN-6	 P.197		ø6/4 x M5
	M-5AU-3	Barb fitting for soft tubing 	For soft nylon tubing For polyurethane tubing	ø3.18/2.18 x M5 ø3.18/2 x M5
	M-5AU-4	 P.197	For soft nylon and polyurethane tubing	ø4/2.5 x M5 ø6/4 x M5
	M-5AU-6	 P.197		ø6/4 x M5
	M-5ALN-4	Barb elbow for nylon tubing 	• For nylon • Body rotates at 360° around the stud axis	ø4/2.5 x M5 ø6/4 x M5
	M-5ALN-6	 P.197		ø6/4 x M5
	M-5ALU-3	Barb elbow for soft tubing 	Body rotates at 360° around the stud axis For soft nylon tubing For polyurethane tubing	ø3.18/2.18 x M5 ø3.18/2 x M5
	M-5ALU-4	 P.197	For soft nylon and polyurethane tubing	ø4/2.5 x M5 ø6/4 x M5
	M-5ALU-6	 P.197		ø6/4 x M5
M5	M-5ALHN-4	Barb elbow (H) for nylon tubing 	Body rotates at 360° around the stud axis For nylon tubing	ø4/2.5 x M5 ø6/4 x M5
	M-5ALHN-6	 P.197		ø6/4 x M5
	M-5ALHU-3	Barb elbow (H) for soft tubing 	Body rotates at 360° around the stud axis For soft nylon tubing For polyurethane tubing	ø3.18/2.18 x M5 ø3.18/2 x M5
	M-5ALHU-4	 P.197	For soft nylon and polyurethane tubing	ø4/2.5 x M5 ø6/4 x M5
	M-5ALHU-6	 P.197		ø6/4 x M5
	M-5H-4	Hose nipple 	For nylon, soft nylon and polyurethane tubing	ø4/2.5 x M5
	M-5H-6	 P.197		ø6/4 x M5
	M-5HL-4	Hose elbow 	• For nylon, soft nylon and polyurethane tubing	ø4/2.5 x M5
	M-5HL-6	 P.198	• Body rotates at 360° around the stud axis	ø6/4 x M5
	M-5HLH-4	Hose elbow (H) 		ø4/2.5 x M5
M-5HLH-6	 P.198		ø6/4 x M5	
M-5L	Elbow  P.198	One-sided 90° elbow	M5 female x M5 female	

Series	Model	Description	Application	Note
M5	M-5T	tee  P.198	Both sides allow 90° connection	M5 female x M5 female x M5 female
	M-5UL	Universal elbow  P.198	Body rotates at 360° around the stud axis	M5 female x M5 male
	M-5UT	Universal tee  P.198	Body rotates at 360° around the stud axis	M5 female x M5 female x M5 male
	M-5J	Extension fitting  P.198	Solid piece moves fitting up from workpiece	M5 male x M5 female
	M-5N	Nipple  P.198	Fitting to workpiece and fitting to fitting connection	M5 male x M5 male
	M-5UN	Universal nipple  P.198	Body rotates at 360° around the stud axis	M5 male x M5 male PAT.
	M-5E	Bulkhead union  P.198	Panel-mount connection	M5 female x M5 female
	M-5ER	Bulkhead reducer  P.199	Reduction from Rc 1/8 to M5 including panel or bracket mounting	Rc 1/8 x M5 female
	M-5M	Manifold  P.199	For reducing Rc 1/8 female be diverted to up to 9, M5 stations, including panel or bracket mounting	Rc 1/8 x M5 female (9 stations)
	M-5B	Bushing  P.199	For reducing R 1/8 female to M5.	R 1/8 x M5 female
M-5P	Plug  P.199	Use to plug unused M5 port.		

- KQ2**
- KQB2**
- KS**
- KX**
- KM**
- KF**
- M**
- H/DL**
- L/LL**
- KC**
- KK**
- KK130**
- DM**
- KDM**
- KB**
- KR**
- KA**
- KQG2**
- KG**
- KFG2**
- MS**
- KKA**
- KP**
- LQ**
- MQR**
- T**
- IDK**

M Series

M3 Series

Barb Fitting for Soft Tubing: M-3AU-3

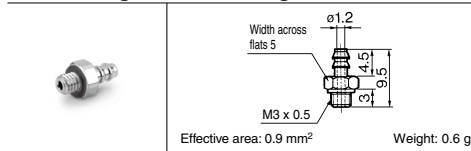

Barb Fitting for Soft Tubing: M-3AU-4

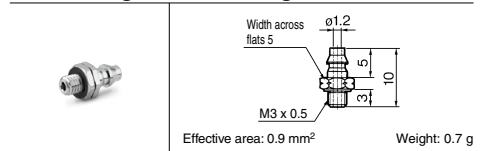

Barb Elbow for Soft Tubing: M-3ALU-3

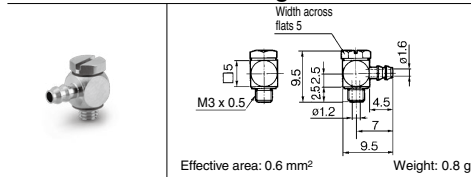

Barb Elbow for Soft Tubing: M-3ALU-4

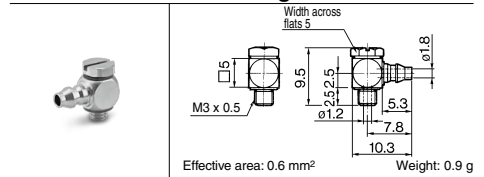

Universal Elbow: M-3UL

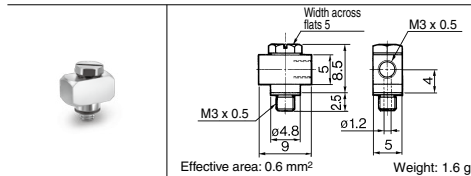

Universal Tee: M-3UT

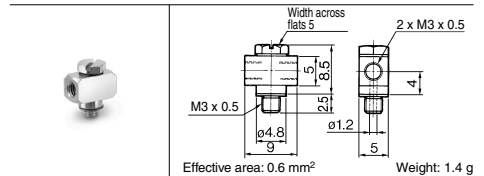

Nipple: M-3N

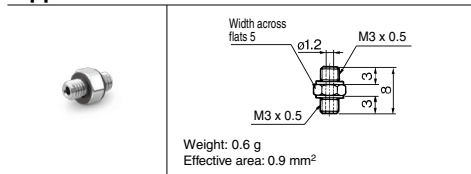

Plug: M-3P

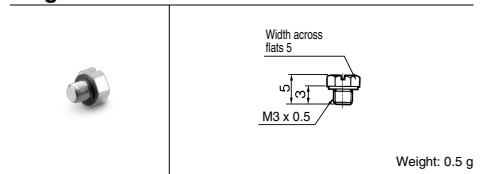

R 1/8 Series

Barb Fitting for Nylon Tubing, Soft Tubing: M-01A□-4/-6

Applicable tubing	Model	A	B	ϕC	Effective area (mm ²)	Weight (g)
Nylon tubing	M-01AN-4	15.1	5	1.8	2.1	6.4
	M-01AN-6	17.1	7	2.5	4.0	6.6
Soft tubing	M-01AU-4	15.1	5	1.8	2.1	6.5
	M-01AU-6	17.1	7	2.5	4.0	6.7

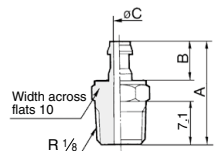

Hose Nipple: M-01H-4/-6

Model	A	B	ϕC	ϕD	E	M	Effective area (mm ²)	Weight (g)
M-01H-4	18.6	8.5	1.8	6.5	7	5	2.1	7.1
M-01H-6	19.6	9.5	3	8.5	8	6	5.5	7.7

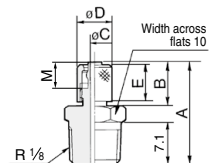

M5 Series

Barb Fitting for Nylon Tubing: M-5AN-4/-6



Model	A	B	øC	Effective area (mm ²)	Weight (g)
M-5AN-4	12	5	1.8	2.1	1.6
M-5AN-6	14	8	2.5	4.0	1.7

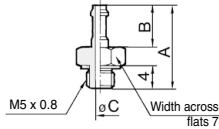

Barb Fitting for Soft Tubing: M-5AU-3/-4/-6



Model	A	B	øC	Effective area (mm ²)	Weight (g)
M-5AU-3	11.5	4.5	1.6	1.7	1.5
M-5AU-4	12	5	1.8	2.1	1.6
M-5AU-6	14	7	2.5	4.0	1.8

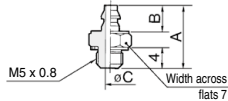

Barb Elbow for Nylon Tubing: M-5ALN-4/-6
Barb Elbow for Soft Tubing: M-5ALU-3/-4/-6



Model	A	B	C	øD	Effective area (mm ²)	Weight (g)
M-5ALN-4	13	9	5	1.8	1.4	4.0
M-5ALN-6	15	11	7	2.5	2.4	4.4
M-5ALU-3	13	9	4.5	1.6	1.1	4.0
M-5ALU-4	13.5	9.5	5	1.8	1.4	4.1
M-5ALU-6	15.5	11.5	7	2.5	2.4	4.5

M-5ALN-4
M-5ALU-3/-4

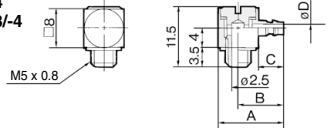

M-5ALN-6
M-5ALU-6

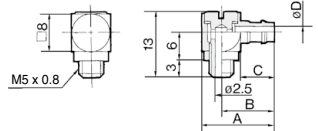

Barb Elbow for Nylon Tubing: M-5ALHN-4/-6
Barb Elbow for Soft Tubing: M-5ALHU-3/-4/-6



Model	A	B	C	øD	Effective area (mm ²)	Weight (g)
M-5ALHN-4	12	8.5	5	1.8	1.4	3.2
M-5ALHN-6	14	10.5	7	2.5	2.4	3.7
M-5ALHU-3	12	8.5	4.5	1.6	1.1	3.2
M-5ALHU-4	12.5	9	5	1.8	1.4	3.3
M-5ALHU-6	14.5	11	7	2.5	2.4	3.9

M-5ALHN-4
M-5ALHU-3/-4

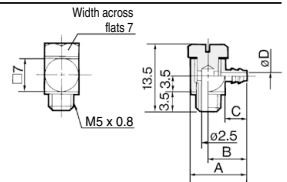

M-5ALHN-6
M-5ALHU-6

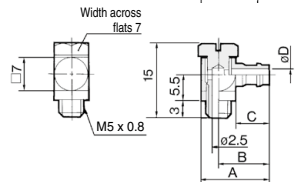

Hose Nipple: M-5H-4/-6



Model	A	B	C	øD	øE	H	M	Effective area (mm ²)	Weight (g)
M-5H-4	15.5	8.5	7	1.8	6.5	7	5	2.1	2.7
M-5H-6	16.5	9.5	8	2.5	8.5	8	6	4.0	3.9

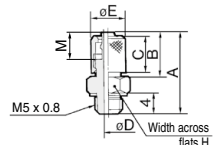

KQ2

KQB2

KS

KX

KM

KF

M

H/DL

L/LL

KC

KK

KK130

DM

KDM

KB

KR

KA

KQG2

KG

KFG2

MS

KKA

KP

LQ

MQR

T

IDK

M Series

M5 Series

Hose Elbow: M-5HL-4/-6



Model	A	B	C	D	øE	øF	M	Effective area (mm ²)	Weight (g)
M-5HL-4	16.5	12.5	8.5	7	1.8	6.5	5	1.4	4.4
M-5HL-6	17.5	13.5	9.5	8	2.5	8.5	6	2.4	5.2

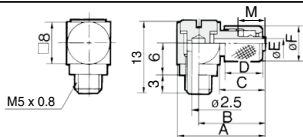

Hose Elbow: M-5HLH-4/-6



Model	A	B	C	D	øE	øF	G	H	I	M	Effective area (mm ²)	Weight (g)
M-5HLH-4	15.5	12	8.5	7	1.8	6.5	5.5	15	7	5	1.4	4.5
M-5HLH-6	17.5	13.5	9.5	8	2.5	8.5	6	16	8	6	2.4	6.6

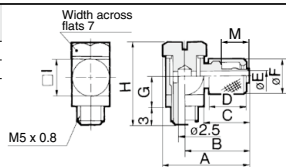

Elbow: M-5L

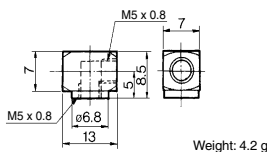

Tee: M-5T

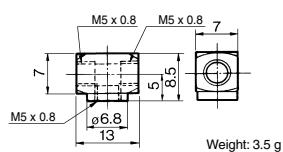

Universal Elbow: M-5UL

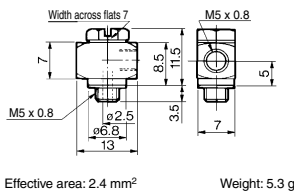

Universal Tee: M-5UT

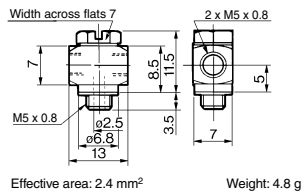

Extension Fitting: M-5J

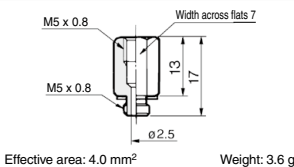

Nipple: M-5N

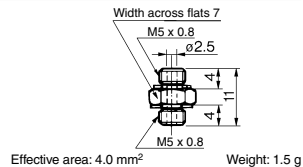

Universal Nipple: M-5UN

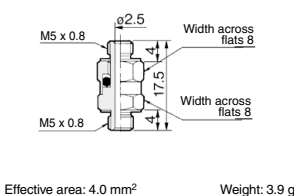

Bulkhead Union: M-5E

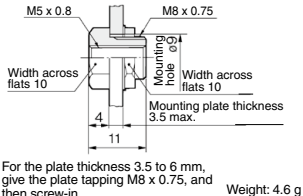

M5 Series

Bulkhead Reducer: M-5ER

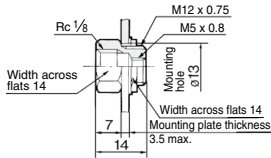

For the plate thickness 3.5 to 6 mm, give the plate tapping M12 x 0.75, and then screw-in.

Weight: 12 g

Manifold: M-5M

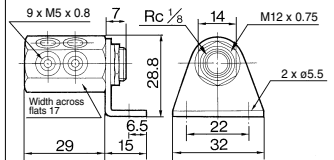

Panel mounting plate thickness max. 3.5 mm
For the plate thickness 3.5 to 6 mm, give the plate tapping M12 x 0.75, and then screw-in.

Weight: 59 g

Bushing: M-5B

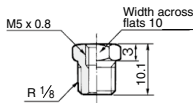

Weight: 5.8 g

Plug: M-5P

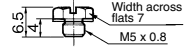

Weight: 1.3 g

⚠ Precautions

- Be sure to read this before handling the products.
- Refer to back page 50 for Safety Instructions and pages 13 to 17 for Fittings and Tubing Precautions.

Tightening of M3/M5 Threads

⚠ Caution

1. Tighten by hand, and give it an additional turn with a wrench.
Please check the number of tightening revolutions using the table below.
If tightened excessively, thread portion may be damaged and gasket may be deformed. This will cause air leakage. On the contrary, if tightened insufficiently, thread may loosen causing air leakage.

Thread	Model	Number of tightening rotations
M3	M-3AU-□	Approx. 1/4 rotations
	M-3N	
	M-3P	
	M-3ALU-□	Approx. 1/2 rotations
	M-3UL	
M-3UT		
M5	M-5AN-□	Approx. 1/6 to 1/4 rotations ^(Note)
	M-5AU-□	
	M-5H-□	
	M-5J	
	M-5N	
	M-5UN	
	M-5P	Approx. 1/2 rotations ^(Note)
	M-5ALN-□	
	M-5ALU-□	
	M-5ALHN-□	
	M-5ALHU-□	
	M-5HL-□	
	M-5HLH-□	
M-5UL		
M-5UT		

(Note) As a guideline, the tightening torque should be 1 to 1.5 N·m.

Use of Tube with Hose Nipple

⚠ Caution

1. Cut the tube perpendicularly to the tube axis to a little longer than required length. (Use tube cutter "TK-1", "TK-2", "TK-3", "TK-5" or "TK-6".)
2. Pass the tube through the cap nut.
3. Push the tube until it comes to the end of the barb portion, or it may cause air leakage or hose releasing.
4. Tighten the cap nut firmly by hand on the fitting.

Use of Tube with Barb Fitting

⚠ Caution

1. Cut the tube perpendicularly to the tube axis to a little longer than required length. (Use tube cutter "TK-1", "TK-2", "TK-3", "TK-5" or "TK-6".)
2. Push the tube until it comes to the end of the barb portion, or it may cause air leakage or release hose.

KQ2

KQB2

KS
KX

KM

KF

M

H/DL
L/LL

KC

KK

KK130

DM

KDM

KB

KR

KA

KQG2

KG

KFG2

MS

KKA

KP

LQ

MQR

T

IDK



1 Gasket Material Modification

Symbol	Specifications	
X83	Gasket material: Stainless steel 304, NBR	
	Applicable thread	Gasket part no.
	M3	M-3G2
	M5 ^{Note)}	M-5G2
X226	Gasket material: Stainless steel 304, FKM	
	Applicable thread	Gasket part no.
	M3	M3G-DPH00489
X112	Gasket material: Stainless steel 316, Special FKM	
	Applicable thread	Gasket part no.
	M5	M-5G3

Note) Compatible with only models using M-5GH.

Spare Parts

Description	Part no.	Applicable thread	Material	Applicable model
Gasket	M-3G	M3	PVC	—
	M-3G3		Stainless steel 304, NBR	M Series, For M3 thread
	M-5G1	M5	PVC	—
	M-5G2		Stainless steel 304, NBR	M Series, For M5 thread
	M-5G3		Stainless steel 316, Special FKM	—
	M-5GH		Nylon 66, GF30%	M-5AL□-6, M-5ALH□-6 M-5HL-4, 6, M-5HLH4, 6
Cap nut	M-5-4-P01	—	C3604 (With electroless nickel plated)	M-01H-4, M-5H-4 M-5HL-4, M-5HLH-4
	M-5-6-P01	—	C3604 (With electroless nickel plated)	M-01H-6, M-5H-6 M-5HL-6, M-5HLH-6