

S Couplers

KK/KKH Series

RoHS

The pulling strength for the plugs and sockets has been improved.
Twice as strong as the current models.

KK Series

- With sleeve lock (Except for KK2)
- Effective area **3.8 to 82 mm²**



KK2 Series



KK3/4/6 Series

KKH Series

- Without sleeve lock
- Effective area is equivalent to that of KK series.



KQ2

KQB2

KS
KX

KM

KF

M

H/DL
L/LL

KC

KK

KK130

DM

KDM

KB

KR

KA

KQG2

KG

KFG2

MS

KKA

KP

LQ

MQR

T

IDK

Variations

KK Series 215 to 223

Male thread type

Series	Port size					
	M5	R1/8	R1/4	R3/8	R1/2	R3/4
KK2	●					
KK3		●		●		
KK4			●	●	●	
KK6				●	●	●

Female thread type

Series	Port size			
	M5	Rc1/8	Rc1/4	Rc3/8
KK2	●			
KK3		●		●
KK4			●	●
KK6				●

Nut fitting type (for fiber reinforced urethane hose)

Series	Applicable hose I.D./O.D. mm					
	5/8	6/9	6.5/10	8/12	8.5/12.5	11/16
KK3	●	●	●	●		
KK4	●	●	●	●	●	
KK6				●		●

One-touch fitting type (Straight/Elbow/Bulkhead)

Series	Applicable tubing O.D. mm						
	φ3.2	φ4	φ6	φ8	φ10	φ12	φ16
KK2	●	●	●	●	●		
KK3		●	●	●	●		
KK4			●	●	●	●	
KK6						●	●



KK3/4/6 Series



KK2 Series

KKH Series 224 to 226

Male thread type

Series	Port size			
	R1/8	R1/4	R3/8	R1/2
KKH3	●	●	●	
KKH4	●	●	●	●

Female thread type

Series	Port size		
	Rc1/8	Rc1/4	Rc3/8
KKH3	●	●	●
KKH4	●	●	●

Nut fitting type (for fiber reinforced urethane hose)

Series	Applicable hose I.D./O.D. mm				
	5/8	6/9	6.5/10	8/12	8.5/12.5
KKH3	●	●	●	●	
KKH4	●	●	●	●	●



KKK Series Stainless steel type 341 to 348

Male/Female thread type

Series	Port size							
	R-Rc1/8	R-Rc1/4	R-Rc3/8	R-Rc1/2	R-Rc3/4	R-Rc1	R-Rc1 1/4	R-Rc1 1/2
KKK3	●	●	●					
KKK4		●	●	●				
KKK6			●	●		●		
KKK7				●	●	●		
KKK8					●		●	
KKK9						●	●	●



S Couplers

KK Series



The pulling strength for the plugs and sockets has been improved.

Twice

as strong as the current models

We standardized the product with a sleeve cover. Changing the lock ring material to a shock absorbent PBT further improved the shock absorbent performance.

Employs a unique connection method

A slim body design and large effective area are achieved with a construction that does not use steel balls and therefore does not restrict the flow path.

Lock ring
Shock absorbent PBT

No spring located in the flow path
Loss of effective area is minimized because there is no valve spring to block the flow path.

Check valve end configuration facilitates rectifying effect
Allows smooth flow of fluids.

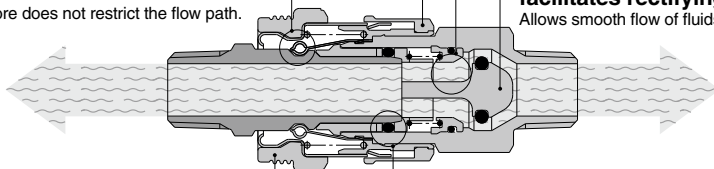

Sleeve cover

(Except for KK2 series)

Low leakage seal construction
Reliable sealing is achieved by surface contact.

Lightweight

Together with a reduction of the body size, pressing parts and resin parts are used to achieve an overall weight reduction.

Series	Plug no.	Socket no.	Effective area (mm ²) <small>Note 1)</small>	Body O.D. (mm)	Mass (g) <small>Note 2)</small>
KK2 Series	KK2P-M5M	KK2S-M5M	3.8	ø10.0	6.1
KK3 Series	KK3P-01MS	KK3S-01MS	20	ø20.2	20.1
KK4 Series	KK4P-02MS	KK4S-02MS	39	ø28.0	44.1
KK6 Series	KK6P-04MS	KK6S-04MS	82	ø31.6	90.1

Note 1) Values when plug and socket are connected.

Note 2) Values for socket only.

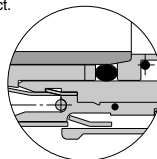

One-touch fitting type standardized

Four types from ø3.2 to ø16 added to series.

Flow is possible from the plug side or socket side.

Fluids: Air and Water

One-touch connection

Simple connection with one hand simplifies work.

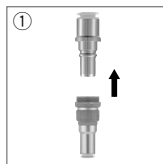

Sleeve lock mechanism

Prevents accidents caused by unexpected separation.

Note) Except for M5 type (KK2 series).



KQ2

KQB2

KS
KX

KM

KF

M

H/DL
L/LL

KC

KK

KK130

DM

KDM

KB

KR

KA

KQG2

KG

KFG2

MS

KKA

KP

LQ

MQR

T

IDK

Plug (P)

Male thread type

	Body size	Port size	Part no.
	M5	M5 x 0.8	KK2P-M5M
		R 1/8	-01MS
	1/8	R 1/8	KK3P-01MS
		R 1/4	-02MS
		R 3/8	-03MS
	1/4	R 1/8	KK4P-01MS
R 1/4		-02MS	
R 3/8		-03MS	
R 1/2		-04MS	
1/2	R 1/2	KK6P-03MS	
	R 1/2	-04MS	
	R 3/4	-06MS	

Female thread type

	Body size	Port size	Part no.
	M5	M5 x 0.8	KK2P-M5F
		Rc 1/8	KK3P-01F
	1/8	Rc 1/4	-02F
		Rc 3/8	-03F
		Rc 1/4	KK4P-02F
	1/4	Rc 3/8	-03F
Rc 3/8		KK6P-03F	
Rc 3/8		-04F	
Rc 1/2		-06F	

Nut fitting type (for fiber reinforced urethane hose)

	Body size	Applicable hose I.D. (O.D.) mm	Part no.
	1/8	5/8	KK3P-50N
		6/9	-60N
		6.5/10	-65N
	1/4	5/8	KK4P-50N
		6/9	-60N
		6.5/10	-65N
8/12		-80N	
8.5/12.5		-85N	
1/2	8/12	KK6P-80N	
	8.5/12.5	-85N	
	11/16	-110N	

Straight type with One-touch fitting

	Body size	Applicable tubing O.D. mm	Part no.
	M5	3.2	KK2P-23H
		4	-04H
		6	-06H
	1/8	4	KK3P-04H
		6	-06H
		8	-08H
		10	-10H
		6	KK4P-06H
	1/4	8	-08H
		10	-10H
		12	-12H
		12	KK6P-12H
1/2	16	-16H	

Elbow type with One-touch fitting

	Body size	Applicable tubing O.D. mm	Part no.
	M5	3.2	KK2P-23L
		4	-04L
		6	-06L
	1/8	4	KK3P-04L
		6	-06L
		8	-08L
		10	-10L
		6	KK4P-06L
	1/4	8	-08L
		10	-10L
		12	-12L
		12	KK6P-12L
1/2	16	-16L	

Bulkhead type with One-touch fitting

	Body size	Applicable tubing O.D. mm	Part no.
	M5	3.2	KK2P-23E
		4	-04E
		6	-06E
	1/8	4	KK3P-04E
		6	-06E
		8	-08E
		10	-10E
		6	KK4P-06E
	1/4	8	-08E
		10	-10E
		12	-12E
		12	KK6P-12E
1/2	16	-16E	

Socket (S)

Male thread type

	Body size	Port size	Part no.
	M5	M5 x 0.8	KK2S-M5M
		R 1/8	-01MS
	1/8	R 1/8	KK3S-01MS
		R 1/4	-02MS
		R 3/8	-03MS
	1/4	R 1/8	KK4S-01MS
R 1/4		-02MS	
R 3/8		-03MS	
R 1/2		-04MS	
1/2	R 1/2	KK6S-03MS	
	R 1/2	-04MS	
	R 3/4	-06MS	

Female thread type

	Body size	Port size	Part no.
	M5	M5 x 0.8	KK2S-M5F
		Rc 1/8	KK3S-01F
	1/8	Rc 1/4	-02F
		Rc 3/8	-03F
		Rc 1/4	KK4S-02F
	1/4	Rc 3/8	-03F
Rc 3/8		KK6S-03F	
Rc 3/8		-04F	
Rc 1/2		-06F	

Nut fitting type (for fiber reinforced urethane hose)

	Body size	Applicable hose I.D. (O.D.) mm	Part no.
	1/8	5/8	KK3S-50N
		6/9	-60N
		6.5/10	-65N
	1/4	5/8	KK4S-50N
		6/9	-60N
		6.5/10	-65N
8/12		-80N	
8.5/12.5		-85N	
1/2	8/12	KK6S-80N	
	8.5/12.5	-85N	
	11/16	-110N	

Straight type with One-touch fitting

	Body size	Applicable tubing O.D. mm	Part no.
	M5	3.2	KK2S-23H
		4	-04H
		6	-06H
	1/8	4	KK3S-04H
		6	-06H
		8	-08H
		10	-10H
		6	KK4S-06H
	1/4	8	-08H
		10	-10H
		12	-12H
		12	KK6S-12H
1/2	16	-16H	

Elbow type with One-touch fitting

	Body size	Applicable tubing O.D. mm	Part no.
	M5	3.2	KK2S-23L
		4	-04L
		6	-06L
	1/8	4	KK3S-04L
		6	-06L
		8	-08L
		10	-10L
		6	KK4S-06L
	1/4	8	-08L
		10	-10L
		12	-12L
		12	KK6S-12L
1/2	16	-16L	

Bulkhead type with One-touch fitting

	Body size	Applicable tubing O.D. mm	Part no.
	M5	3.2	KK2S-23E
		4	-04E
		6	-06E
	1/8	4	KK3S-04E
		6	-06E
		8	-08E
		10	-10E
		6	KK4S-06E
	1/4	8	-08E
		10	-10E
		12	-12E
		12	KK6S-12E
1/2	16	-16E	

S Couplers

KK Series



KK2 Series

KK3/4/6 Series

Symbol

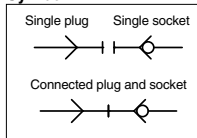

Specifications

Fluid	Air, Water <small>Note 2)</small>
Operating pressure range <small>Note 1)</small>	KK2: -100 kPa to 1 MPa KK3: -90 kPa to 1 MPa KK4/6: 0 to 1 MPa
Proof pressure	1.5 MPa
Ambient and fluid temperature	Air: -5 to 60°C Water: 5 to 40°C (No freezing)
Plating, Sealant	Electroless nickel plated (copper-free and fluorine-free application), With male thread sealant

Note 1) Do not use the S couplers with a leak tester or for vacuum retention because they are not guaranteed for zero leakage.

Note 2) Deionized water is not recommended for use as it may affect the material used in the fittings. In addition, it is known to degrade the water quality.

Performance

Plug and socket connection	One-touch connection and release
Check valve	Socket: Built-in check valve (standard)
Sleeve lock mechanism <small>Note)</small>	Manual locking type (standard)

Note) KK2 series is not provided with lock mechanism.

Effective Area

Body size	Plug	Socket	Effective area mm ²
M5	KK2P-M5M	KK2S-M5M	3.8
1/8	KK3P-01MS	KK3S-01MS	20
1/4	KK4P-02MS	KK4S-02MS	39
1/2	KK6P-04MS	KK6S-04MS	82

How to Order

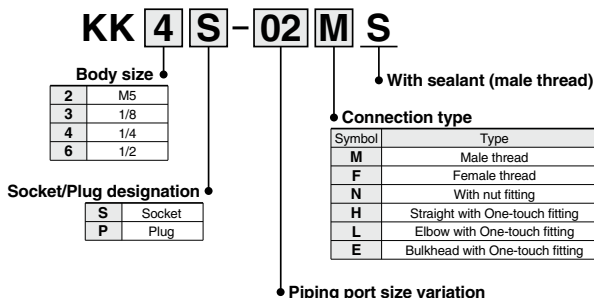

Male/Female thread type

Symbol	Thread size
M5	M5 x 0.8
01	R, Rc 1/8
02	R, Rc 1/4
03	R, Rc 3/8
04	R, Rc 1/2
06	R, Rc 3/4

One-touch fitting type

Symbol	Applicable tubing O.D. mm
23	ø3.2
04	ø4
06	ø6
08	ø8
10	ø10
12	ø12
16	ø16

Nut fitting type

Symbol	Applicable hose I.D./O.D. mm
50	5/8
60	6/9
65	6.5/10
80	8/12
85	8.5/12.5
110	11/16

For details on body size and port size variation combinations for each model, refer to the charts on the Dimensions page.

- KQ2
- KQB2
- KS
- KX
- KM
- KF
- M
- H/DL
- L/LL
- KC
- KK
- KK130
- DM
- KDM
- KB
- KR
- KA
- KQG2
- KG
- KFG2
- MS
- KKA
- KP
- LQ
- MQR
- T
- IDK

KK Series

Flow Rate Characteristics

Air (0 to 1 MPa)

KK2

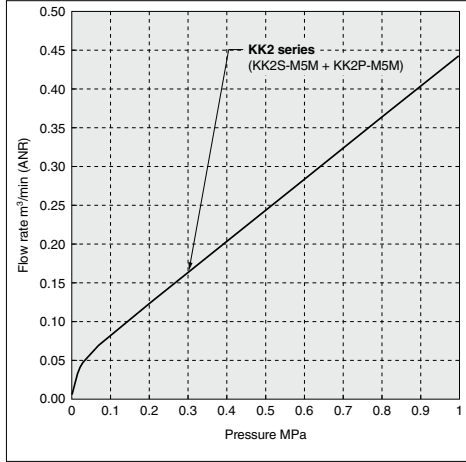

Water (0 to 0.4 MPa)

KK2

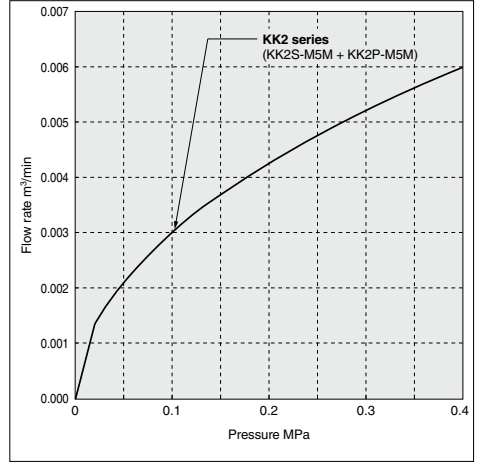

KK3/4/6

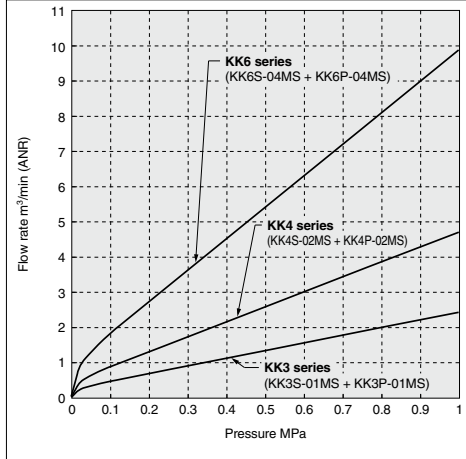

KK3/4/6

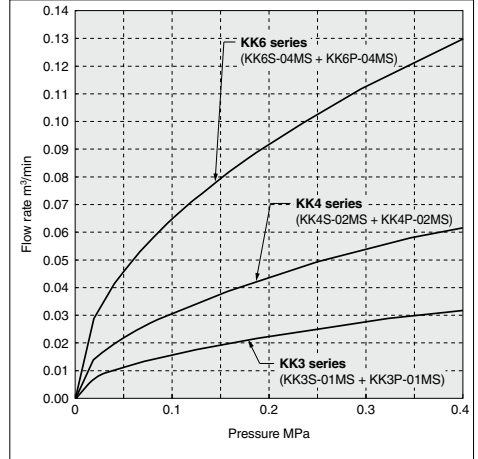

Construction

KK2

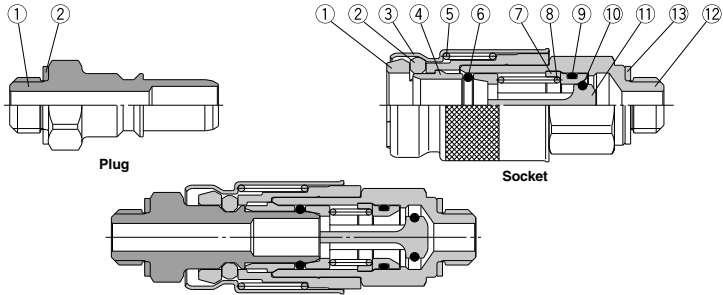

Plug

No.	Description	Material	Note
1	Stem	C3604	Electroless nickel plated
2	Gasket	Stainless steel 304, NBR	

KK2 Series Spare Parts

Description	Part no.	No.
Gasket	M-5G2	Plug ²⁾
		Socket ¹⁾

Socket

No.	Description	Material	Note
1	Spacer	PBT	
2	Chuck	PBT	
3	Sleeve	C2680	Electroless nickel plated
4	Collar	C3604	Electroless nickel plated
5	Sleeve spring	Stainless steel 304	
6	Plug O-ring	NBR	
7	Valve seat	PBT	
8	Valve spring	Stainless steel 304	
9	Valve seat O-ring	NBR	
10	Valve O-ring	FKM	
11	Valve	PBT	
12	Socket body	C3604	Electroless nickel plated
13	Gasket	Stainless steel 304, NBR	

KK3/4/6

<With One-touch fitting >

<With One-touch fitting >

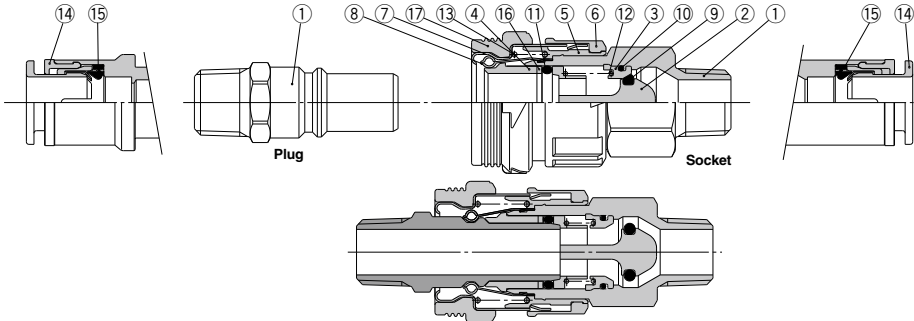

Plug

No.	Description	Material	Note
1	Stem	C3604	Electroless nickel plated
14	Cassette	—	
15	Seal	NBR	

KK/KKH Series Spare Parts

Description	Part no.	No.
Sleeve cover	KK3S-P01	Socket ¹⁾
	KK4S-P01	
	KK6S-P01	

Socket



No.	Description	Material	Note
1	Body	C3604	Electroless nickel plated
2	Valve	PBT	
3	Valve seat	PBT	
4	Collar	PBT	
5	Spacer	PBT	
6	Lock ring	Shock absorbent PBT	
7	Sleeve	Cold rolled carbon steel sheet	Electroless nickel plated
8	Chuck	Stainless steel 304	
9	Valve O-ring	FKM	
10	Valve seat O-ring	NBR	
11	Plug O-ring	NBR	
12	Valve spring	Stainless steel 304	
13	Sleeve spring	Stainless steel 304	
14	Cassette	—	
15	Seal	NBR	
16	Collar 2	Stainless steel 304	
17	Sleeve cover	Weather resistant NBR	

KQ2
KQB2
KS KX
KM
KF
M
H/DL L/LL
KC
KK
KK130
DM
KDM
KB
KR
KA
KQG2
KG
KFG2
MS
KKA
KP
LQ
MQR
T
IDK

KK Series

Dimensions/Plug (P)

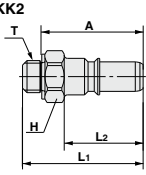
Male thread type

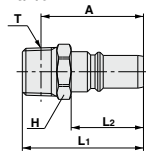
		Body size	Model	T Connection port size	H Width across flats	L1	L2	A*	Min. bore size	Effective area mm ²	Weight g		
 KK2	M5	KK2P-M5M	M5 x 0.8	7	18.8	12.3	15.8	2.2	4.4	2.6	 KK2		
			-01MS	R 1/8	10							22.3	19.2
		KK3P-01MS	R 1/8	10	29.5	26.4	6.0	22.6	8.4	28.1			
	1/8	-02MS	R 1/4	14	32.9	18.4						27.4	14.2
			-03MS	R 3/8	17	34.3						28.9	17.0
	 KK3/4/6	1/4	KK4P-01MS	R 1/8	14	36.1	25.2	33.0	9.0	50.9		20.2	 KK3/4/6
-02MS				R 1/4	14	39.7					34.2		
1/2			-03MS	R 3/8	17	41.1	31.0	35.7	11.0	76.0	44.7		
		-04MS		R 1/2	22	45.3	38.2	13.0	106.2	53.7			
1/2		KK6P-03MS	R 3/8	19	46.9	31.0	41.5	11.0	76.0	44.7			
			-04MS	R 1/2	22						51.1	44.0	
		-06MS	R 3/4	27	55	45.5	13.0	106.2	94.4				

* Reference dimension for R threads after installation.

Female thread type

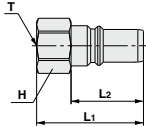
		Body size	Model	T Connection port size	H Width across flats	L1	L2	Min. bore size	Effective area mm ²	Weight g		
	M5	KK2P-M5F	M5 x 0.8	8	17.6	12.3	3.4	8.1	2.6			
			KK3P-01F	Rc 1/8	14						28.3	10.4
	1/8	-02F	Rc 1/4	17	33.5	18.4	6.0	22.6	20.8			
			-03F	Rc 3/8	19						35.3	23.2
			1/4	KK4P-02F	Rc 1/4						17	37.2
	-03F	Rc 3/8			19	39.8	24.6					
	1/2	KK6P-03F	Rc 3/8	19	43.3	31.0	13.0	106.2	28.6			
			-04F	Rc 1/2	24						50.2	43.9

Nut fitting type (for fiber reinforced urethane hose)

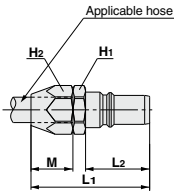
		Body size	Model	Applicable hose I.D./O.D.	H1 Width across flats	H2 Width across flats	L1	L2	M	Min. bore size	Effective area mm ²	Weight g					
	1/8	KK3P-50N	5/8	14	14	36.1	18.4	13.7	4.5	12.7	21.4						
			-60N	6/9		17							39.9	16.5	5.4	18.3	38.8
			-65N	6.5/10		17							39.9	16.5	5.9	21.9	35.9
	1/4	KK4P-50N	5/8	17	14	43.9	25.2	13.7	4.5	12.7	34.7						
			-60N	6/9		17							46.7	16.5	5.4	18.3	48.4
		-65N	6.5/10		17	46.7		17.4	7.4	34.4	53.2						
			-80N	8/12		19							19	7.8	38.2	55.6	
			-85N	8.5/12.5		19							19	7.4	34.4	60.5	
	1/2	KK6P-80N	8/12		53.4	31.0	7.4	34.4	60.5								
			-85N	8.5/12.5						53.4	7.8		38.2	62.8			
			-110N	11/16	24	24	57.2	20.1	10.2	65.4	96.5						

Straight type with One-touch fitting

(mm)



Body size	Model	Applicable tubing O.D.	øD1	øD2	L1	L2	M	Min. bore size	Effective area mm ²			Weight g
									Urethane tubing	Nylon tubing		
M5	KK2P-23H	ø3.2	10.0	7.0	23.7	12.3	12.7	2.5	3.7	4.4	3.3	
	-04H	ø4		8.0								
	-06H	ø6		10.0								26.7
1/8	KK3P-04H	ø4	12.0	10.0	35.4	18.4	17.0	6.0	10.1	12.8	9.1	
	-06H	ø6	14.0	12.0								
	-08H	ø8	16.0	14.0								38.6
	-10H	ø10	19.0	17.0								39.7
	KK4P-06H	ø6	14.0	12.0								46.2
-08H	ø8	16.0	14.0									
-10H	ø10	19.0	17.0									
1/4	KK6P-12H	ø12	21.0	19.0	47.5	31.0	22.0	9.0	40.2	50.9	30.0	
	-12H											
	-16H	ø16	26.0	23.8								56.1

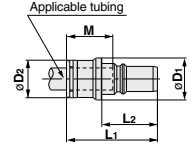

Elbow type with One-touch fitting

(mm)



Body size	Model	Applicable tubing O.D.	øD1	øD2	L1	L2	L3	M	Min. bore size	Effective area mm ²			Weight g				
										Urethane tubing	Nylon tubing						
M5	KK2P-23L	ø3.2	10.0	9.3	24.0	12.3	16.5	12.7	2.5	3.6	4.3	5.8					
	-04L	ø4															
	-06L	ø6		11.6									25.1				
1/8	KK3P-04L	ø4	10.4	31.6	18.4	18.0	20.0	17.0	4.5	10.1	11.4	8.0					
	-06L	ø6	12.8	32.8													
	-08L	ø8	12.0	34.0									23.0	18.5	15.0	16.8	9.7
	-10L	ø10	17.0	36.0									26.5	21.0	18.0	18.5	23.0
	KK4P-06L	ø6	14.0	12.8									40.2	25.2	23.0	18.5	6.0
-08L	ø8	15.2	41.4														
-10L	ø10	17.0	42.8														
1/4	KK6P-12L	ø12	19.0	44.0	20.9	31.0	28.5	22.0	9.0	29.0	29.6	28.0					
	-12L																
	-16L	ø16	21.0	53.5									34.0	25.0	13.0	42.8	58.7

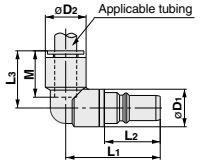

Bulkhead type with One-touch fitting

(mm)



Body size	Model	Applicable tubing O.D.	T Threads	H1 Width across flats	H2 Width across flats	L1	L2	L3	M	Min. bore size	Effective area mm ²			Weight g					
											Urethane tubing	Nylon tubing							
M5	KK2P-23E	ø3.2	M8 x 0.75	10	11	28.3	12.3	12.5	12.7	2.5	3.7	4.4	6.0						
	-04E	ø4	M9 x 0.75																
	-06E	ø6	M11 x 0.75	14	14									28.6	12.7	13.5	3.4	8.1	8.1
1/8	KK3P-04E	ø4	M12 x 1			39.3	16.9	16.0	3.2	3.9	5.6	16.6							
	-06E	ø6	M14 x 1	17	17								40.2	16.8	17.0	4.7	10.1	12.8	22.3
	-08E	ø8	M16 x 1	19	19								43.4	20.0	18.5	6.0	15.7	22.6	30.2
	-10E	ø10	M20 x 1	22	24								46.4	22.0	21.0	7.7	27.6	35.3	54.7
	KK4P-06E	ø6	M14 x 1	17	17								47.0	25.2	16.8	17.0	4.7	10.1	12.8
-08E	ø8	M16 x 1	19	19	50.2														
-10E	ø10	M20 x 1	22	24	53.2														
1/4	KK6P-12E	ø12	M22 x 1	24	27	54.2	31.0	23.0	22.0	9.0	40.2	50.9	75.2						
	-12E																		
	-16E	ø16	M28 x 1.5	30	32									62.6	24.5	25.0	13.0	63.5	106.2

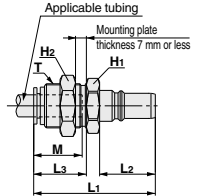



[Click here for applicable color caps.](#)

- QK2
- QKB2
- KS
KX
- KM
- KF
- M
- H/DL
L/L
- KC
- KK
- KK130
- DM
- KDM
- KB
- KR
- KA
- QKG2
- KG
- KFG2
- MS
- KKA
- KP
- LQ
- MQR
- T
- IDK

KK Series

Dimensions/Socket (S)

Male thread type



Body size	Model	T Connection port size	H Width across flats	øD	L1	L2 When connected	A1*	A2* When connected	Min. bore size	Effective area mm ²	Weight g	
KK2 	M5	KK2S-M5M	M5 x 0.8	8	10.0	24.7	26.2	21.3	23.2	2.2	3.8	6.1
		-01MS	R 1/8	10		24.4	25.9		22.8	4.7	5.8	9.1
	1/8	KK3S-01MS	R 1/8	14	20.2	36.6	39.1	33.5	36.0	6.0	20.4	20.1
-02MS		R 1/4	37.0			39.5	31.5	34.0	9.0	21.1	19.2	
-03MS		R 3/8	37.6			40.1	32.2	34.5			29.0	
KK3/4/6 	1/4	KK4S-01MS	R 1/8	19	28.0	49.5	53.2	46.4	50.1	6.0	22.9	47.5
		-02MS	R 1/4			50.5	54.2	45.0	48.7	9.0	38.9	44.1
		-03MS	R 3/8			48.9	52.6	43.5	47.2	11.0	40.4	50.9
	1/2	KK6S-03MS	R 3/8	24	31.6	48.8	52.5	41.7	45.4	13.0	42.7	61.2
		-04MS	R 1/2			59.1	64.4	53.7	59.0	11.0	71.7	87.9
		-06MS	R 3/4			59.3	64.6	52.2	57.5	13.0	82.3	90.1
						60.2	65.5	50.7	56.0	15.0	83.8	113.3

* Reference dimension for R threads after installation.

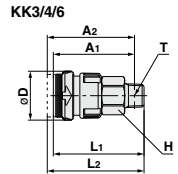
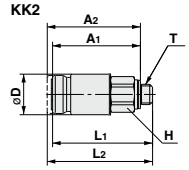
(mm)



Female thread type

Body size	Model	T Connection port size	H Width across flats	øD	L1	L2 When connected	Min. bore size	Effective area mm ²	Weight g	
KK2 	M5	KK2S-M5F	M5 x 0.8	8	10.0	25.3	26.8	4.2	5.4	6.4
	1/8	KK3S-01F	Rc 1/8	14		20.2	36.0	38.5	8.2	20.6
		-02F	Rc 1/4	17	40.1		42.6	21.1		34.4
KK3/4/6 	1/4	KK4S-02F	Rc 1/4	19	28.0	50.4	54.1	10.9	39.6	56.9
		-03F	Rc 3/8			41.9	44.4			38.8
		-04F	Rc 1/2			51.1	54.8	14.4	42.7	46.2
	1/2	KK6S-03F	Rc 3/8	24	31.6	58.6	63.9	18.0	83.1	93.6
		-04F	Rc 1/2			61.0	66.3	18.0	83.8	87.4

(mm)

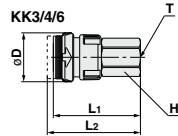
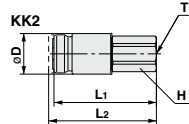

Nut fitting type (for fiber reinforced urethane hose)

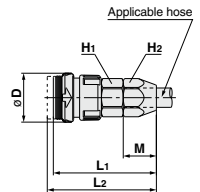

Body size	Model	Applicable hose I.D./O.D.	H1 Width across flats	H2 Width across flats	øD	L1	L2 When connected	M	Min. bore size	Effective area mm ²	Weight g	
1/8 	KK3S-50N	5/8	14	14	20.2	42.6	45.1	13.7	4.5	12.2	32.1	
	-60N	6/9	17	17		44.4	46.9	16.5	5.4	18.3	48.7	
	-65N	6.5/10				5.9	19.2	46.4				
1/4	KK4S-50N	5/8	14	17	28.0	54.1	57.8	13.7	4.5	12.2	55.8	
	-60N	6/9				5.4	20.4	69.3				
	-65N	6.5/10				5.9	24.1	66.8				
	1/2	KK6S-80N	8/12	19	24	31.6	55.4	59.1	17.4	7.4	35.1	68.5
		-85N	8.5/12.5				7.8	71.1				
		-80N	8/12				7.4	36.6		107.5		
1/2	KK6S-80N	8/12	24	24	31.6	66.0	71.3	20.1	7.8	41.2	110.2	
	-110N	11/16				64.4	69.7		10.2	68.4	119.8	

(mm)



Straight type with One-touch fitting

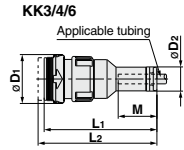
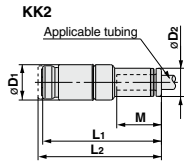

(mm)

Body size	Model	Applicable tubing O.D.	øD1	øD2	L1	L2 When connected	M	Min. bore size	Effective area mm ²		Weight g
									Urethane tubing	Nylon tubing	
KK2 	M5	KK2S-23H	ø3.2	7.0	33.8	35.3	12.7	2.5	3.8	4.6	6.4
		-04H	ø4	8.0	33.6	35.1		3.4	4.0	4.8	6.5
		-06H	ø6	10.0	33.9	35.4	13.5	4.7	5.8	5.8	7.9
KK3/4/6 	1/8	KK3S-04H	ø4	10.0	46.6	49.1	16.0	3.2	3.8	5.8	22.5
		-06H	ø6	12.0	47.1	49.6	17.0	4.7	10.4	13.4	24.4
		-08H	ø8	14.0	48.9	51.4	18.5	6.2	16.8	18.9	27.3
1/4	1/4	KK4S-06H	ø6	17.0	49.9	52.4	21.0	7.7	19.1	19.1	37.1
		-08H	ø8	17.0	58.2	61.9	17.0	4.7	10.4	13.4	51.4
		-10H	ø10	14.0	60.1	63.8	18.5	6.2	18.3	21.8	51.3
1/2	1/2	KK6S-12H	ø12	19.0	61.5	65.2	21.0	7.7	27.0	29.4	54.8
		-12H	ø12	19.0	62.5	66.2	22.0	9.2	30.5	32.0	59.4
		-16H	ø16	25.7	70.1	75.4	25.0	13.2	42.7	48.8	84.1
					25.7	72.3	77.6	25.0	53.4	62.5	99.9



Elbow type with One-touch fitting

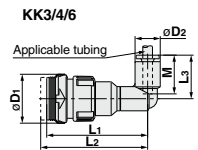
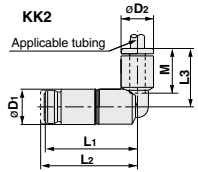

(mm)

Body size	Model	Applicable tubing O.D.	øD1	øD2	L1	L2 When connected	L3	M	Min. bore size	Effective area mm ²		Weight g
										Urethane tubing	Nylon tubing	
KK2 	M5	KK2S-23L	ø3.2	9.3	26.0	27.5	16.5	12.7	2.5	3.7	4.4	6.7
		-04L	ø4	11.6	27.2	28.3	16.6	13.5	4.5	5.6	5.6	7.2
		-06L	ø6	10.4	41.7	44.2	18.0	16.0	3.0	3.7	5.3	23.2
KK3/4/6 	1/8	KK3S-04L	ø4	12.8	42.9	45.4	20.0	17.0	4.5	10.1	11.4	24.0
		-06L	ø6	15.2	43.1	45.6	23.0	18.5	6.0	15.0	16.8	25.0
		-08L	ø8	18.5	42.9	45.4	26.5	21.0	7.5	18.0	18.5	34.4
1/4	1/4	KK4S-06L	ø6	12.8	54.3	58.0	20.0	17.0	4.5	10.1	11.4	53.5
		-08L	ø8	15.2	55.5	59.2	23.0	18.5	6.0	17.5	19.8	53.1
		-10L	ø10	18.5	54.2	57.9	26.5	21.0	7.5	24.7	27.5	54.7
1/2	1/2	KK6S-12L	ø12	20.9	55.4	59.1		9.0	29.0	29.6	57.0	
		-12L	ø12	20.9	66.3	71.6	28.5	22.0	9.0	29.0	29.6	57.0
		-16L	ø16	26.5	66.9	72.2	34.0	25.0	13.0	38.1	39.7	91.4
									50.3	58.7	93.5	



Bulkhead type with One-touch fitting

(mm)

Body size	Model	Applicable tubing O.D.	T Threads	H1 Width across flats	H2 Width across flats	øD	L1	L2 When connected	L3	M	Min. bore size	Effective area mm ²		Weight g
												Urethane tubing	Nylon tubing	
KK2 	M5	KK2S-23E	M8 x 0.75	10	10	10.0	33.8	35.3	13.0	12.7	2.5	3.8	4.6	9.6
		-04E	M8 x 0.75	11	11	10.0	33.5	35.0			3.4	4.0	4.8	9.1
		-06E	M11 x 0.75	14	14	10.0	33.9	35.4	13.1	13.5	4.7	5.8	5.8	12.6
KK3/4/6 	1/8	KK3S-04E	M12 x 1	14	14	17.0	46.6	49.1	16.9	16.0	3.2	3.8	5.8	29.6
		-06E	M14 x 1	17	17	17.0	47.1	49.6	16.8	17.0	4.7	10.4	13.4	39.4
		-08E	M16 x 1	19	19	20.2	49.0	51.5	20.0	18.5	6.2	16.8	18.9	43.4
1/4	1/4	KK4S-06E	M20 x 1	22	24	21.0	49.9	52.4	22.0	21.0	7.7	19.1	19.1	68.3
		-08E	M16 x 1	19	19	28.0	58.2	61.9	16.8	17.0	4.7	10.4	13.4	57.2
		-10E	M20 x 1	22	24	28.0	60.1	63.8	20.0	18.5	6.2	18.3	21.8	60.6
1/2	1/2	KK6S-12E	M22 x 1	24	27	31.6	61.7	65.4	22.0	21.0	7.7	27.0	29.4	86.8
		-12E	M22 x 1	24	27	31.6	62.7	66.4	23.0	22.0	9.2	30.5	32.0	105.7
		-16E	M28 x 15	30	32	31.6	70.1	75.4	24.5	25.0	13.2	42.7	48.8	116.0
											53.4	62.5	183.2	

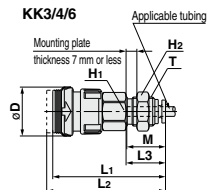
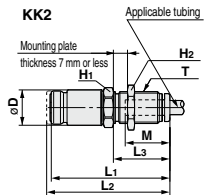

[Click here for applicable color caps.](#)

S Couplers

KKH Series



- Able to absorb drop impact (equivalent to impact energy of 0.5 J).
- The pulling strength for the plugs and sockets has been improved. Twice as strong as the current models.

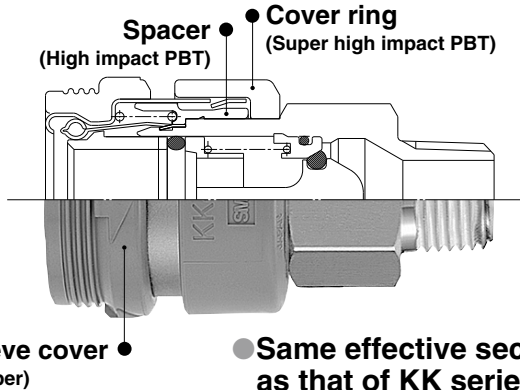

- Same effective sectional area as that of KK series.

Plug (P)

Male thread type

	Body size	Connection port size	
		Connection port size	Part no.
	1/8	R 1/8	KK3P-01MS
		R 1/4	-02MS
		R 3/8	-03MS
1/4	R 1/8	KK4P-01MS	
	R 1/4	-02MS	
	R 3/8	-03MS	
	R 1/2	-04MS	

Female thread type

	Body size	Connection port size	
		Connection port size	Part no.
	1/8	Rc 1/8	KK3P-01F
		Rc 1/4	-02F
		Rc 3/8	-03F
1/4	Rc 1/4	KK4P-02F	
	Rc 3/8	-03F	

Nut fitting type (for fiber reinforced urethane hose)

	Body size	Applicable hose I.D./O.D. mm	Part no.
			Part no.
	1/8	5/8	KK3P-50N
		6/9	-60N
		6.5/10	-65N
1/4	5/8	KK4P-50N	
	6/9	-60N	
	6.5/10	-65N	
	8/12	-80N	
	8.5/12.5	-85N	

Socket (S)

Male thread type

	Body size	Connection port size	
		Connection port size	Part no.
	1/8	R 1/8	KKH3S-01MS
		R 1/4	-02MS
		R 3/8	-03MS
1/4	R 1/8	KKH4S-01MS	
	R 1/4	-02MS	
	R 3/8	-03MS	
	R 1/2	-04MS	

Female thread type

	Body size	Connection port size	
		Connection port size	Part no.
	1/8	Rc 1/8	KKH3S-01F
		Rc 1/4	-02F
		Rc 3/8	-03F
1/4	Rc 1/4	KKH4S-02F	
	Rc 3/8	-03F	

Nut fitting type (for fiber reinforced urethane hose)

	Body size	Applicable hose I.D./O.D. mm	Part no.
			Part no.
	1/8	5/8	KKH3S-50N
		6/9	-60N
		6.5/10	-65N
1/4	5/8	KKH4S-50N	
	6/9	-60N	
	6.5/10	-65N	
	8/12	-80N	
	8.5/12.5	-85N	

KKH series are only available as sockets.
KK series should be used as plugs.

S Couplers KKH Series

RoHS



Symbol

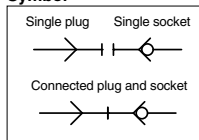

Specifications

Fluid	Air, Water ^{Note 2)}
Operating pressure range ^{Note 1)}	KKH3: -90 kPa to 1 MPa KKH4: 0 to 1 MPa
Proof pressure	1.5 MPa
Ambient and fluid temperature	Air: -5 to 60°C Water: 5 to 40°C (No freezing)
Plating, Sealant	Electroless nickel plated (copper-free and fluorine-free application), With male thread sealant
Connection plug	KK series plug

Note 1) Do not use the S couplers with a leak tester or for vacuum retention because they are not guaranteed for zero leakage.
Note 2) Deionized water is not recommended for use as it may affect the material used in the fittings. In addition, it is known to degrade the water quality.

Performance

Plug and socket connection	One-touch connection and release
Check valve	Socket: Built-in check valve (standard)
Sleeve lock mechanism	_____

Effective Area

Body size	Plug	Socket	Effective area mm ²
1/8	KK3P-01MS	KKH3S-01MS	20
1/4	KK4P-02MS	KKH4S-02MS	39

The flow rate characteristics are the same as those of KK series.
Please refer to page 218.

How to Order

KKH 4 S-02 M S

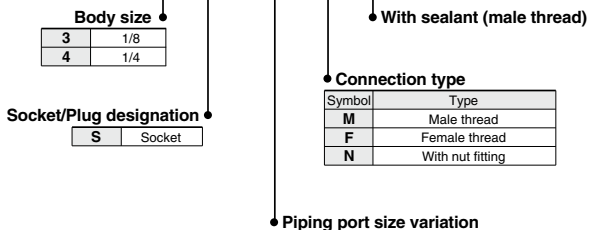

For details on body size and port size variation combinations for each model, refer to the charts on the Dimensions page.

KQ2
KQB2
KS
KX
KM
KF
M
H/DL
L/LL
KC
KK
KK130
DM
KDM
KB
KR
KA
KQG2
KG
KFG2
MS
KKA
KP
LQ
MQR
T
IDK

KKH Series

Dimensions/Socket (S)

Male thread type

(mm)



Body size	Model	T Connection port size	H Width across flats	øD	L1	L2 When connected	A1*	A2* When connected	Min. bore size	Effective area mm ²	Weight g							
1/8	KKH3S-01MS	R 1/8	14	20.2	36.6	39.1	33.5	36.0	6.0	20.4	20.3							
	-02MS	R 1/4																
	-03MS	R 3/8																
1/4	KKH4S-01MS	R 1/8	19	28.0	49.5	53.2	46.4	50.1	6.0	22.9	48.7							
	-02MS	R 1/4																
	-03MS	R 3/8																
	-04MS	R 1/2	22									48.8	52.5	41.7	45.4	13.0	42.7	62.4

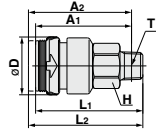

* Reference dimension for R threads after installation.

Female thread type

(mm)



Body size	Model	T Connection port size	H Width across flats	øD	L1	L2 When connected	Min. bore size	Effective area mm ²	Weight g				
1/8	KKH3S-01F	Rc 1/8	14	20.2	36.0	38.5	8.2	20.6	23.8				
	-02F	Rc 1/4	17							40.1	42.4	21.1	33.1
	-03F	Rc 3/8	19							41.9	44.3		
1/4	KKH4S-02F	Rc 1/4	19	28.0	50.4	54.1	10.9	39.6	58.1				
	-03F	Rc 3/8								51.1	54.8	14.4	42.7

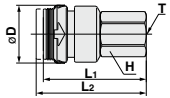

Nut fitting type (for fiber reinforced urethane hose)

(mm)



Body size	Model	Applicable hose I.D./O.D.	H1 Width across flats	H2 Width across flats	øD	L1	L2 When connected	M	Min. bore size	Effective area mm ²	Weight g											
1/8	KKH3S-50N	5/8	14	14	20.2	42.6	45.1	13.7	4.5	12.2	32.3											
	-60N	6/9	17	17								44.4	46.9	16.5	5.9	19.2	46.6					
	-65N	6.5/10																54.1	57.8	13.7	4.5	12.2
1/4	KKH4S-50N	5/8	19	14	28.0	56.8	60.5	16.5	5.4	20.4	70.5											
	-60N	6/9										17	17	56.8	60.5	16.5	5.9	24.1	68.0			
	-65N	6.5/10																		19	19	55.4
	-80N	8/12										7.8	36.6	72.3								
	-85N	8.5/12.5																				

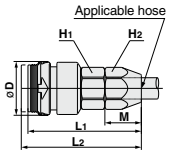

KKH series are only available as sockets. KK series should be used as plugs. For dimensions, please refer to page 220.



S Couplers Specific Product Precautions 1

Be sure to read this before handling the products.
Refer to back page 50 for Safety Instructions and pages 13 to 17 for Fittings and Tubing Precautions.

Selection

Warning

1. Cannot be used as a stop valve that requires zero leakage. A certain amount of leakage is allowed during operation.
2. S coupler connection possibilities are shown in the table below.

Series	KK	KKH	KKA	KK130
KK	○	○		
KKH	○	○		
KKA			○	
KK130				○

- * Before using a KK130 series S coupler with another manufacturer's product, be sure to confirm compatibility with the manufacturer, etc.
3. Do not couple or uncouple the S coupler during pressurization or while residual pressure remains. The coupler may shoot out under the influence of the pressure.
 4. Never apply pressure to an S coupler without check valve when it is uncoupled. The piping may move violently and cause danger.
 5. An S coupler without check valve experiences leakage of fluid inside piping when it is uncoupled. Pay special attention in using fluid that can cause danger such as fluid of a high temperature and pressure. Additional use of a stop valve is recommended.
 6. The S coupler becomes extremely hot when the product is operated at a high temperature. Be sure to refrain from touching it as doing so may result in burns. Insert or remove the plug and socket only after the product has returned to a normal temperature.

Caution

1. For a plug and socket connection, select a plug and socket with the same body size. If their body sizes are different, they cannot be connected. This will cause leakage, damage, and disconnection of the plug. Inserting a plug other than the specialized plug into the socket may result in equipment damage.
2. Do not use couplers with flammable, explosive, or toxic substances, such as gas, gas fuel, and refrigerant. They may leak from inside the tubing to the outside.
3. Do not use the S coupler with steam. Corrosion of the metal material and deterioration of the sealing material may result from long-term use with steam.

Mounting

Warning

1. Do not use couplers where rotation normally occurs. The couplers may be damaged.
2. Avoid applications in which vibration or shock is directly applied to the fittings.
3. Fittings with sleeve lock mechanism must be locked during operation in order to prevent sudden disconnection.
4. Install a stop valve at the supply pressure side of the socket. Emergency shutdown may not be possible without it.

Caution

1. Mount so that couplers and tubing are not subjected to twisting, pulling or moment loads. This can cause damage to couplers and flattening, bursting or disconnection of tubing, etc.

Handling

Warning

1. When connecting the plug, hold the plug securely. The plug may be uncoupled due to reaction at the time of connection.
2. When connecting KK, KKH, and KKA series plugs, push the plug in until you hear it click into the socket. In addition, be sure to refrain from touching the sleeve until you are sure that the plug has been pushed all the way in. Failure to do so may result in a malfunction. When connecting KK130 series plugs, after pulling the sleeve straight back, push the plug in until you are sure that it has been pushed all the way in. For all S couplers, after inserting the plug, pull on it gently to make sure that it doesn't come out from the socket. If the plug is not properly inserted into the socket, the plug may fly out of the product due to pressure.
3. When connecting the plug, insert it straight into the socket. If not inserted straight, the socket and/or plug may be damaged or cause a malfunction.
4. When releasing the plug, hold it securely. The connection pipe may move due to reacting stress and/or residual pressure on the plug side.
5. Be sure to move the sleeve straight in relation to the socket. If it is rotated at all, a malfunction may result.
6. Do not press the inside of the socket with an incompatible plug and/or with a stick. The internal fluid may be ejected and cause a dangerous situation. Also, the ejecting internal fluid may cause the sealings to come apart resulting in the product not functioning.
7. If foreign matter adheres to the plug O-ring, be sure to wipe it off. If air blow is performed with the air gun air outlet in close proximity to the plug O-ring, the plug O-ring may come off.
8. For products with a sleeve lock mechanism, do not apply pressure when rotating the sleeve. If the KK130 series is pressurized during rotation, the detent of the locked and released positions may become unclear due to the pressure. In addition, operate the product in accordance with the arrows on the sleeve surface. Failure to do so may result in problems with the attaching and detaching of the mechanism.
9. If the plug and socket cannot be separated due to a malfunction of the sleeve, do not try to forcibly pull out the plug. Instead, turn the sleeve clockwise (viewed from the plug insertion side) 3 to 5 times, and then check to see if the sleeve moves properly. If the sleeve still doesn't move properly, try turning it counter-clockwise in the same manner, and check it again. If the aforementioned method fails to work, loosen the plug and socket connection thread and remove it from the piping.
10. Water is an incompressible fluid. Design the piping while taking the characteristics of the fluid into consideration. If the plug or socket piping of the type with a check valve is filled with water and the valve above said piping is closed, removing the plug or socket will result in the piping between the check valve and the closed valve filling with water. (Refer to the circuit example.) In order to reinsert the plug or socket while in the aforementioned state, the water would need to be compressed to allow room for the plug or socket. However, as this is not possible, the plug and socket cannot be reinserted while in this state.

Circuit example

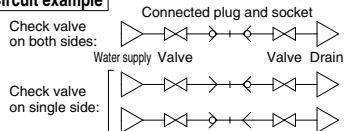

KQ2

KQB2

KS
KX

KM

KF

M

H/DL
L/LL

KC

KK

KK130

DM

KDM

KB

KR

KA

KQG2

KG

KFG2

MS

KKA

KP

LQ

MQR

T

IDK



S Couplers Specific Product Precautions 2

Be sure to read this before handling the products.
Refer to back page 50 for Safety Instructions and pages 13 to 17 for Fittings and Tubing Precautions.

Plug Insertion Force in Pressurized Condition

Insertion Force of KK series

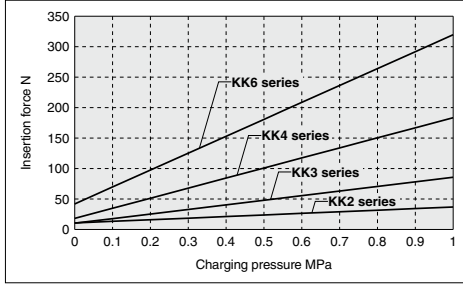

Insertion Force of KKA series

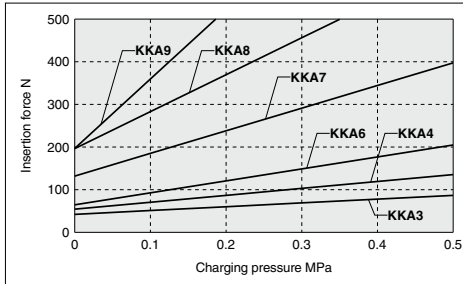

Insertion Force of KK130 series

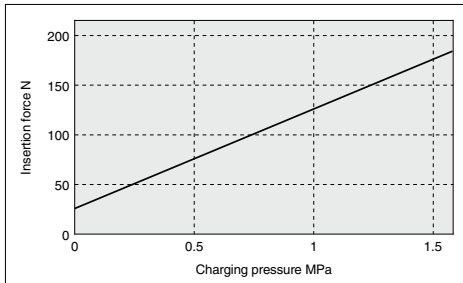

Handling of Barb Fittings and Nut Fittings

⚠ Caution

1. When using a nut fitting, insert the hose all the way to the end and securely tighten it with the nut. When the insertion of the hose or the tightening of the nut are not sufficient, the hose may slip out.
2. Disconnection may occur depending on the material or the O.D. accuracy of the hose; therefore be sure to confirm the applicability of the hose.
3. Prepare a hose band separately when using a barb fitting. If the hose band is not used, the hose may come off.

Handling of Fittings

⚠ Caution

1. Tightening of the fittings with a sealant
Tighten fittings with sealant using the proper tightening torques in the table below. As a rule, they should be tightened 2 to 3 turns with a tool after first tightening by hand.

Connection thread size	Proper tightening torque N·m
NPT, R 3/4	28 to 30
NPT, R 1	36 to 38
NPT, R 1 1/4	40 to 42
NPT, R 1 1/2	48 to 50

KQ2
KQB2
KS KX
KM
KF
M
H/DL L/LL
KC
KK
KK130
DM
KDM
KB
KR
KA
KQG2
KG
KFG2
MS
KKA
KP
LQ
MQR
T
IDK

