

Stainless Steel One-touch Fittings

KG Series

RoHS

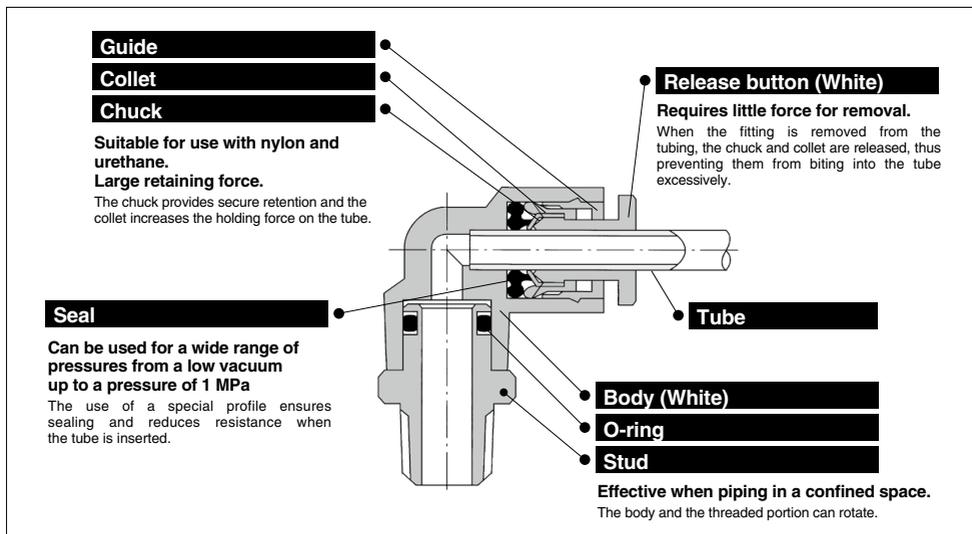

Stainless steel specifications applicable to corrosive environments

Stainless steel 303 adopted for metal elements

Suitable for use in CRT production lines where contact with copper must be avoided, food processing machines where water or salt water splashes and clean room where discoloration of copper material and corrosion must be avoided.



Applicable Tubing

Tubing material	FEP, PFA, Nylon, Soft nylon, ⁽¹⁾ Polyurethane
Tubing O.D.	ø4, ø6, ø8, ø10, ø12, ø16

Note 1) Soft nylon tubing is not compatible with water.

Specifications

Fluid		Air/Water ^(2, 3)
Operating pressure range⁽⁴⁾		-100 kPa to 1 MPa
Proof pressure		3 MPa
Ambient and fluid temperature		-5 to 60°C (Water: 0 to 40°C) (No freezing)
Thread	Mounting section	JIS B 0203 (Taper thread for piping) JIS B 0205 (Metric coarse thread)
	Nut section	JIS B 0205 (Metric fine thread)
Seal on the threads		With sealant or none ⁽⁵⁾

Note 2) The surge pressure must be under the maximum operating pressure.

Note 3) Deionized water is not recommended for use as it may affect the material used in the fittings.

In addition, it is known to degrade the water quality.

Note 4) Do not use the fittings with a leak tester or for vacuum retention because they are not guaranteed for zero leakage.

Note 5) Suffix "S" to the part number, if w/ seal is desired.

Principal Parts Material

Body	Stainless steel 303, PBT
Stud	Stainless steel 303 (Thread portion)
Chuck	Stainless steel 304
Guide	Stainless steel 304, Stainless steel 303, PBT
Collet, Release button	POM
Seal, O-ring	NBR
Gasket	Stainless steel 304, NBR



Made to Order

(Refer to page 318 for details.)



KQ2

KQB2

KS
KX

KM

KF

M

H/DL
L/LL

KC

KK

KK130

DM

KDM

KB

KR

KA

KQG2

KG

KFG2

MS

KKA

KP

LQ

MQR

T

IDK

KG Series

Model

Hex. socket head male connector

KGS P.309



Internal hex. allows thread connection by using an allen wrench for confined spaces.

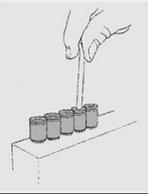

Bulkhead union

KGE P.317



Use to connect tubes through a panel.



Universal male elbow

KGV P.311



Universal male elbow allows thread connection by using a socket wrench for confined spaces.



Extended male elbow

KGW P.313



Basically, it is used together with male elbow. Different point is that it is used for fittings to avoid from interfering with each other by making the pipin two-level.

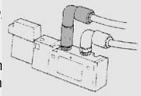

Bulkhead connector

KGE P.317



Use to connect male thread and tube through a panel.

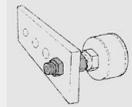

Male connector

KGH P.309



Use to pipe in the same direction from female thread. Most general type.

Male elbow

KGL P.310



Use to pipe at right angles to female thread. Most general type.

Male branch tee

KGT P.313



Use to branch line from female thread in both 90° directions.

Female connector

KGF P.310



Use to pipe from male thread such as pressure gauge.

Union elbow

KGL P.312



Use to connect tubes at right angles.

Union tee

KGT P.313



Use to connect tubes in both 90° directions.

Straight union

KGH P.310



Use to connect tubes in the same direction.

Plug-in elbow

KGL P.312



Use to change by 90° in a tube fetching direction from One-touch fittings.

Different diameter tee

KGT P.314



Use to connect tubes with size down in both 90° directions.

Different diameter straight

KGH P.310



Use to connect different sized tubes.

Male delta union

KGD P.314



Use to branch line in 90° direction from female thread.

Male run tee

KGY P.314



Use to branch line in the same direction from female thread and in 90° direction.

Branch male elbow

KGLU P.311



Use to branch line at right angles to female thread.

Delta union

KGD P.315



Use to branch line in tripple 90° direction.

Different dia. double union "Y"

KGUD P.316



Use to four-branch line in the same direction.

Branch union elbow

KGLU P.312



Use to branch line at right angles.

Delta branch

KGUD P.315



Use to four-branch line in the same direction from female thread.

Union "Y"

KGU P.316



Use to branch line in the same direction.

Model

Different dia. union "Y"

KGU P.316



Use to connect tubes in the same direction, reducing the size of tubes.

Plug-in reducer

KGR P.316



Use to change size of One-touch fittings.

Tube cap

KGC P.317



Use to plug unused tubing.

Branch

KGU P.315



Use to branch line in the same direction from the female thread.

Male Connector: KGH

<M5>

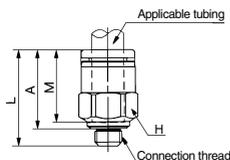

<R>

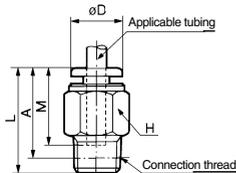

Applicable tubing O.D. (mm)	Connection thread M R	Model	H (width across flats)	L	A*	M	Effective area (mm ²)		Weight (g)
							Nylon	Urethane	
4	M5 x 0.8	KGH04-M5	8	17	13.9	12.7	4	4	2.4
	1/8	KGH04-01	10	21.1	18	16	5.6	4	9
	1/4	KGH04-02	14	19	13.5				
6	M5 x 0.8	KGH06-M5	10	17.8	14.7	13.5	4	4	3.4
	1/8	KGH06-01	12	21.6	18.5				
	1/4	KGH06-02	14	22.5	17				
	3/8	KGH06-03	17	20.9	15.5				
8	1/8	KGH08-01	14	27.1	24	18.5	26.1	18.0	21
	1/4	KGH08-02		26	20.5				
	3/8	KGH08-03	17	20.9	15.5				
10	1/8	KGH10-01	17	29.1	26	21	41.5	29.5	30
	1/4	KGH10-02		33	27.5				
	3/8	KGH10-03		27.9	22.5				
	1/2	KGH10-04		22	26.1				
12	1/4	KGH12-01	19	34	28.5	22	58.3	46.1	34
	3/8	KGH12-03		28.9	23.5				
	1/2	KGH12-04		22	29.1				
16	3/8	KGH16-03	24	38.4	32	24	81	(81)	61
	1/2	KGH16-04		34.6	26.5				

* Reference dimensions after R thread installation.
Note () : Values for soft nylon.

Hexagon Socket Head Male Connector: KGS

<M5>

<R>

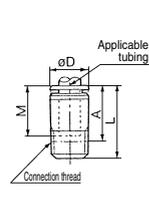
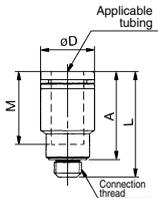

Applicable tubing O.D. (mm)	Connection thread M R	Model	H (width across flats)	ϕD	L	A*	M	Effective area (mm ²)		Weight (g)
								Nylon	Urethane	
4	M5 x 0.8	KGS04-M5	2.5	8	18.7	15.6	12.7	4	4	2.6
	1/8	KGS04-01	3	9.8	23	19	16	4.1	3.6	8
6	M5 x 0.8	KGS06-M5	2.5	10	19.5	16.4	13.5	4	4	3.2
	1/8	KGS06-01	4	11.8	20	17	10.0	9.9	9	
	1/4	KGS06-02		13.8	18					
8	1/8	KGS08-01	5	14	28	24	18.5	17.2	16.2	12
	1/4	KGS08-02	25.5		19.5					
	3/8	KGS08-03	6	17	27.5	21.5				
10	1/8	KGS10-01	5	17	30	26	21	17.2	10.0	18
	1/4	KGS10-02	27.5		21.5					
	3/8	KGS10-03	8		25	20				
	1/2	KGS10-04	22		28	20				
12	1/4	KGS12-01	8	19	33.5	27.5	22	46.0	23	
	3/8	KGS12-03	10		29	22.5				
	1/2	KGS12-04	22		28	20				

* Reference dimensions after R thread installation.

KG Series

Female Connector: KGF

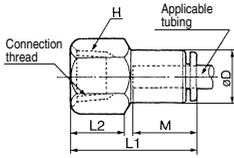

Applicable tubing O.D. (mm)	Connection thread Rc thread	Model	H (width across flats)	øD	L1	L2	M	Effective area (mm ²)		Weight (g)
								Nylon	Urethane	
4	1/8	KGF04-01	14	10	27	11	16	5.6	4	15
	1/4	KGF04-02	17		31	14				23
6	1/8	KGF06-01	14	12	27.5	11	17	13.1	10.4	15
	1/4	KGF06-02	17		31	13				22
	3/8	KGF06-03	19		33.5	15				25
8	1/8	KGF08-01	14	14	29	11	18.5	26.1	18.0	17
	1/4	KGF08-02	17		32.5	13				24
	3/8	KGF08-03	19		33.5	14				24
10	1/4	KGF10-02	17	17	34.5	14	21	41.5	29.5	27
	3/8	KGF10-03	19		36.5	15				30
	1/2	KGF10-04	24		41	18				52
12	1/4	KGF12-02	19	19	35	14	22	58.3	46.1	36
	3/8	KGF12-03	19		37	14				31
	1/2	KGF12-04	24		41	18				52

Straight Union: KGH

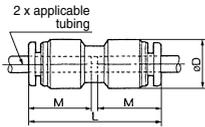

Applicable tubing O.D. (mm)	Model	øD	L	M	Effective area (mm ²)		Weight (g)
					Nylon	Urethane	
4	KGH04-00	10.4	32.5	16	5.6	4	3
6	KGH06-00	12.8	34.5	17	13.1	10.4	4
8	KGH08-00	15.2	38.5	18.5	26.1	18.0	6
10	KGH10-00	18.5	42.5	21	41.5	29.5	11
12	KGH12-00	20.9	44.5	22	58.3	46.1	14

Different Diameter Straight: KGH

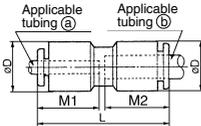

Applicable tubing O.D. (mm)		Model	øD	L	M1	M2	Effective area (mm ²)		Weight (g)
(a)	(b)						Nylon	Urethane	
4	6	KGH04-06	12.8	34.5	16	17	5.6	4	5
6	8	KGH06-08	15.2	38.5	17	18.5	13.1	10.4	6
8	10	KGH08-10	18.5	42	18.5	21	26.1	18.0	11
10	12	KGH10-12	20.9	44.5	21	22	41.5	29.5	14

Male Elbow: KGL



<M5>

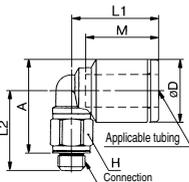

<R>

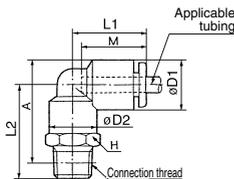

Applicable tubing O.D. (mm)	Connection thread M R	Model	H (width across flats)	(1)		L1	L2	A*	M	Effective area (2)		Weight (g)
				øD1	øD2					mm ²	Urethane	
4	M5 x 0.8	KGL04-M5	7	9.3	-	15.6	13.7	15.3	12.7	3.5	3.5	2.7
	1/8	KGL04-01	10	10.4	10	18	21.1	23	16	4.2	4.2	10
	1/4	KGL04-02	14				25.5	25				19
6	M5 x 0.8	KGL06-M5	7	11.6	-	16.1	14.7	17.4	13.5	3.5	3.5	3.1
	1/8	KGL06-01	10	12.8	10	20	22.1	25.5	17	11.4	9.0	12
	1/4	KGL06-02	14				26.5	27.5				10
	3/8	KGL06-03	17				27.9	29				33
1/2	KGL06-04	22	23.6				28	13				
8	1/8	KGL08-01	12	15.2	12	23	28	30	18.5	21.6	14.9	21
	1/4	KGL08-02	14				29.4	31.5				35
	3/8	KGL08-03	17				26.1	32				25
10	1/8	KGL10-01	14	17	18.5	17	26.5	33	21	35.2	25.0	26
	1/4	KGL10-02	17				30.9	34.5				36
	3/8	KGL10-03	19				35.1	37				63
	1/2	KGL10-04	22				30.5	35.5				28
12	1/8	KGL12-01	17	20.9	17	28.5	31.9	37	22	50.2	39.7	38
	1/4	KGL12-02	19				36.1	39.5				65
	3/8	KGL12-03	22				36.9	44.5				101
16	3/8	KGL16-03	22	26.5	20.9	34	40.1	46	24	71	(71)	101
	1/2	KGL16-04	24				100	(84)				105

* Reference dimensions after R thread installation.

Note 1) For the ø16, this dimension refers to the O.D. of the release button.

Note 2) (): Values for soft nylon.



Branch Male Elbow: KGLU

<M5>

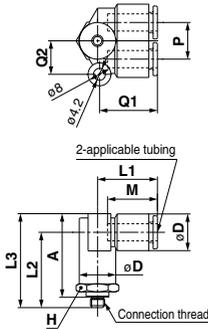

Applicable tubing O.D. (mm)	Connection thread M R	Model	H (width across flats)	øD	L1	L2	L3	A*	M	P	Q1	Q2	Effective area (mm ²)		Weight (g)
													Nylon	Urethane	
4	M5 x 0.8	KGLU04-M5	11	10.4	18.5	24	29.5	25.5	16	10.4	18.5	10	4.3	4.1	10
		KGLU04-01	14			30	35.5	30					6.0	4.1	12
6	M5 x 0.8	KGLU06-M5	13	12.8	21	26.5	33	29.5	17	12.8	20.5	12	4.3	4.3	13
		KGLU06-01				28.6	35.1	32							
		KGLU06-02	14			32.5	39	33.5					13.9	11.0	22
		KGLU06-03	17			33.9	40.4	35							
8	M5 x 0.8	KGLU08-01	17	15.2	24	33.1	40.6	38	18.5	15.2	24.5	14	26.3	18.2	27
		KGLU08-02				36.5	44	38.5							
		KGLU08-03				36.9	44.4	39							
10	M5 x 0.8	KGLU10-02	19	18.5	27	39.5	49	43.5	21	18.5	28	16	40.8	29.0	42
		KGLU10-03				38.9	49.4	44							
		KGLU10-04				22	43.6	53.1							
12	M5 x 0.8	KGLU12-02	22	20.9	29	42	52.5	47	22	20.9	30	18	57.2	45.2	57
		KGLU12-03				42.4	52.9	47.5							
		KGLU12-04				22	45.6	56.1							

* Reference dimensions after R thread installation.

<R>

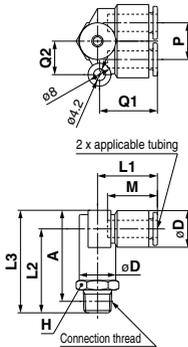

Universal Male Elbow: KGV

<M5>

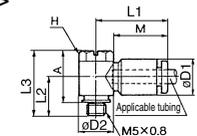

Applicable tubing O.D. (mm)	Connection thread M R	Model	H (width across flats)	øD1	øD2	L1	L2	L3	A*	M	Effective area (mm ²)		Weight (g)
											Nylon	Urethane	
4	M5 x 0.8	KGV04-M5	8	10.4	9.8	20.5	11	18.5	15	16	2.9	2.9	6
		KGV04-01			13.4	22	13.6	25.6	22.5				14
6	M5 x 0.8	KGV06-M5	8	12.8	9.8	23.5	12	18.5	15	17	7.5	5.9	7
		KGV06-01			13.4	24	13.6	25.6	22.5				15
		KGV06-02			10	15.3	23.5	18	30.5				25
8	M5 x 0.8	KGV08-01	12	15.2	17.6	28.5	14.6	27.6	24.5	18.5	16	11.2	24
		KGV08-02			18	31	25.5	30	30				
		KGV08-03			14	20.6	27.5	19.4	35.4				30
10	M5 x 0.8	KGV10-02	14	18.5	20.6	31	19	35	29.5	21	27	20.3	40
		KGV10-03					19.4	35.4	30				49
12	M5 x 0.8	KGV12-03	17	20.9	25.2	34	20.9	37.4	32	22	39	30.8	63
		KGV12-04					24.1	40.6	33.5				80

* Reference dimensions after R thread installation.

<R>

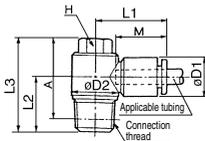

KQ2

KQB2

KS

KX

KM

KF

M

H/DL

L/LL

KC

KK

KK130

DM

KDM

KB

KR

KA

KQG2

KG

KFG2

MS

KKA

KP

LQ

MQR

T

IDK

KG Series



Union Elbow: KGL

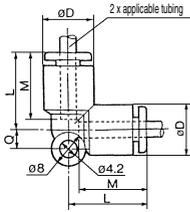

Applicable tubing O.D. (mm)	Model	$\phi D^{(1)}$	L	Q	M2	Effective area (mm ²)		Weight (g)
						Nylon	Urethane	
4	KGL04-00	10.4	18	4.5	16	4.2	4.2	6
6	KGL06-00	12.8	20	5.3	17	11.4	9.0	6
8	KGL08-00	15.2	23	6	18.5	21.6	14.9	10
10	KGL10-00	18.2	26.5	6.8	21	35.2	25.0	17
12	KGL12-00	20.9	28.5	7.5	22	50.2	39.7	21
16	KGL16-00	26.5	34	10	25	100	(84)	29

Note 1) For the $\phi 16$, this dimension refers to the O.D. of the release button.
 Note 2) (): Values for soft nylon.



Branch Union Elbow: KGLU

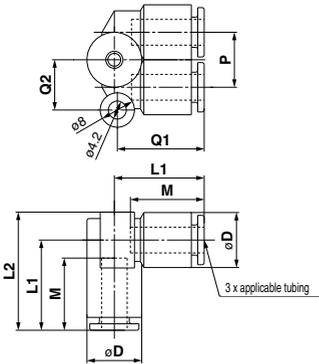

Applicable tubing O.D. (mm)	Model	ϕD	L1	L2	Q1	Q2	M	P	Effective area (mm ²)		Weight (g)
									Nylon	Urethane	
4	KGLU04-00	10.4	18.5	24	18.5	10	16	10.4	6.0	4.1	6
6	KGLU06-00	12.8	21	27.5	20.5	12	17	12.8	13.9	11.0	8
8	KGLU08-00	15.2	24	32	24.5	14	18.5	15.2	26.3	18.2	15
10	KGLU10-00	18.5	27	36.5	28	16	21	18.5	40.8	29.0	25
12	KGLU12-00	20.9	29	40	30	18	22	20.9	57.2	45.2	32



Plug-in Elbow: KGL

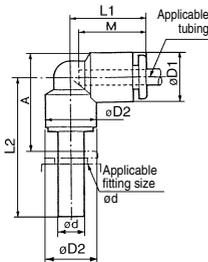

Applicable tube O.D. mm	Applicable fitting size ϕd	Model	$\phi D1$	$\phi D2$	L1	L2	A	M	Effective area (mm ²)		Weight (g)
									Nylon	Urethane	
4	4	KGL04-99	10.4	8	18	25	14.5	16	4.2	4.2	8
6	6	KGL06-99	12.8	10	20	27.5	17	17	11.4	9.0	10
8	8	KGL08-99	15.2	12	22.5	31.5	21	18.5	21.6	14.9	14
10	10	KGL10-99	18.5	14	25.5	35.5	23.5	21	35.2	25.0	25
12	12	KGL12-99	20.9	16	27	37.5	26	22	50.2	39.7	28



Extended Male Elbow: KGW

<M5>

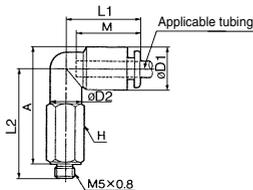

<R>

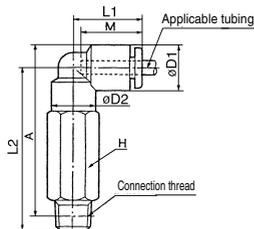

Applicable tubing O.D. (mm)	Connection thread M/R	Model	H (width across flats)	øD1	øD2	L1	L2	A*	M	Effective area (mm ²)		Weight (g)
										Nylon	Urethane	
4	M5x0.8	KGW04-M5	8	10.4	10	18	30	32	16	3.0	3.0	11
		KGW04-01	10				36.6	38.5		4.0	4.0	23
		KGW04-02	14				43	42.5				38
6	M5x0.8	KGW06-M5	8	12.8	10	20	30.5	33.5	17	3.0	3.0	11
		KGW06-01	10				39.1	42.5				26
		KGW06-02	14				45.5	46.5				41
		KGW06-03	17				46.9	48				67
8	M5x0.8	KGW08-01	12	15.2	12	23	42.6	47	18.5	20.5	14.2	47
		KGW08-02	14				49	51				74
		KGW08-03	17				50.4	52.5				66
10	M5x0.8	KGW10-02	17	18.5	17	26.5	56	59.5	21	33.5	23.8	76
		KGW10-03	17				57.4	61				145
		KGW10-04	22				64.1	66				68
12	M5x0.8	KGW12-02	17	20.9	17	28.5	57	62	22	47.7	37.7	78
		KGW12-03	17				58.4	63.5				147
		KGW12-04	22				65.1	68.5				

* Reference dimensions after R thread installation.

KQ2

KQB2

KS

KX

KM

KF

M

H/DL

L/LL

KC

KK

KK130

DM

KDM

KB

KR

KA

KQG2

KG

KFG2

MS

KKA

KP

LQ

MQR

T

IDK

Male Branch Tee: KGT

<M5>

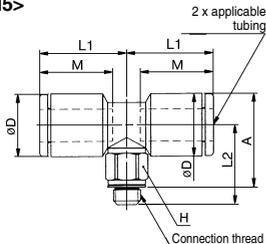

<R>

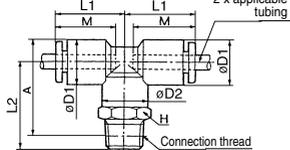

Applicable tubing O.D. (mm)	Connection thread M/R	Model	H (width across flats)	øD1 ⁽¹⁾	øD2	L1	L2	A*	M	Effective area (mm ²) ⁽²⁾		Weight (g)
										Nylon	Urethane	
4	M5x0.8	KGT04-M5	7	9.3	—	15.6	13.7	15.3	12.7	4.3	4.3	3.5
		KGT04-01	10	10.4	10	18	21.1	23	16	6.0	4.1	13
		KGT04-02	14	7	11.6	—	16.1	14.7	17.4	13.5	4.3	4.3
6	M5x0.8	KGT06-01	10	12.8	10	20	22.1	25.5	17	13.9	11.0	20
		KGT06-02	14				26.5	27.5				34
		KGT06-03	17				27.9	29				14
		KGT06-04	22				23.6	28				22
8	M5x0.8	KGT08-01	12	15.2	12	23	28	30	18.5	26.3	18.2	22
		KGT08-02	14				29.4	31.5				36
		KGT08-03	17				29.4	31.5				31
10	M5x0.8	KGT10-01	16	18.5	17	26.5	26.1	32	21	40.8	29.0	29
		KGT10-02	17				29.5	33				39
		KGT10-03	17				30.9	34.5				66
		KGT10-04	22				35.1	37				31
12	M5x0.8	KGT12-02	17	20.9	17	28.5	30.5	35.5	22	57.2	45.2	41
		KGT12-03	17				31.9	37				68
		KGT12-04	22				36.1	39.5				116
16	M5x0.8	KGT16-03	22	26.5	20.9	34	36.9	44.5	25	71	(71)	112
		KGT16-04	22				39.6	46				100

* Reference dimensions after R thread installation.

Note 1) For the ø16, this dimension refers to the O.D. of the release button.

Note 2) (): Values for soft nylon

Union Tee: KGT

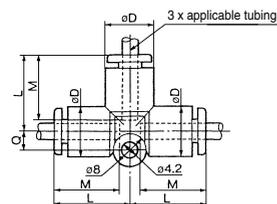

Applicable tubing O.D. (mm)	Model	øD ⁽¹⁾	L	Q	M	Effective area (mm ²) ⁽²⁾		Weight (g)
						Nylon	Urethane	
4	KGT04-00	10.4	18	4.5	16	6.4	4.4	7
6	KGT06-00	12.8	20	5.3	17	13.4	10.6	10
8	KGT08-00	15.2	23	6	18.5	25.6	17.7	15
10	KGT10-00	18.5	26.5	6.8	21	40	28.4	25
12	KGT12-00	20.9	28.5	7.5	22	57.4	45.4	29
16	KGT16-00	26.5	34	10	25	100	(84)	40

Note 1) For the ø16, this dimension refers to the O.D. of the release button.

Note 2) (): Values for soft nylon.

KG Series

Different Diameter Tee: KGT

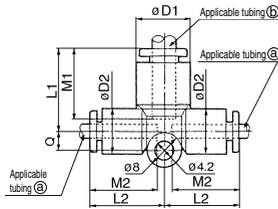

Applicable tubing O.D. (mm)	Model	øD1	øD2	L1	L2	Q	M1	M2	Effective area (mm ²)		Weight (g)
									Nylon	Urethane	
4 6	KGT04-06	12.8	10.4	19.5	18	4.5	17	16	7.1	6.5	5
6 8	KGT06-08	15.2	12.8	22.5	20	5.3	18.5	17	16.4	16.4	8
8 10	KGT08-10	18.5	15.2	26.5	23	6	21	18.5	36	27.2	14
10 12	KGT10-12	20.9	18.5	28.5	26.5	6.8	22	21	56	44.5	21

Male Run Tee: KGY

<M5>

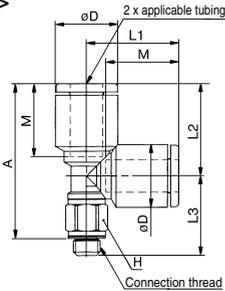

<R>

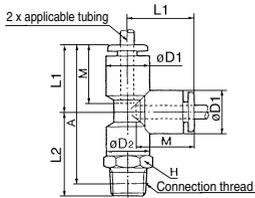

Applicable tubing O.D. (mm)	Connection thread M/R	Model	H (width across flats)	øD1 ⁽¹⁾	øD2	L1	L2	L3	A*	M	Effective area ⁽²⁾ (mm ²)		Weight (g)
											Nylon	Urethane	
4	M5 x 0.8	KGY04-M5	7	9.3	—	15.6	13.7	13.7	25.4	12.7	4.6	4.6	3.5
		1/8 KGY04-01	10	10.4	10	18	21.1	—	36	16	6.4	4.4	13
		1/4 KGY04-02	14	—	—	—	25.5	—	38	—	—	—	—
6	M5 x 0.8	KGY06-M5	7	11.6	—	17.1	14.7	17.1	28.7	13.5	4.6	4.6	4.3
		1/8 KGY06-01	10	—	—	—	22.1	—	39	—	—	—	12
		1/4 KGY06-02	14	12.8	10	20	26.5	—	41	17	13.4	10.6	20
		3/8 KGY06-03	17	—	—	—	27.9	—	42.5	—	—	—	34
		1/2 KGY06-04	22	—	—	—	35.1	—	54.5	—	—	—	66
8	M5 x 0.8	KGY08-M5	7	15.2	12	23	28	—	45.5	18.5	25.6	17.7	22
		1/8 KGY08-01	10	—	—	—	23.6	—	43.5	17	13.4	10.6	14
		1/4 KGY08-02	14	15.2	12	23	28	—	45.5	—	—	—	22
		3/8 KGY08-03	17	—	—	—	29.4	—	47	—	—	—	36
		1/2 KGY08-04	22	—	—	—	35.1	—	49.5	—	—	—	31
10	M5 x 0.8	KGY10-M5	7	18.5	17	26.5	—	—	50.5	21	40.0	28.4	29
		1/8 KGY10-01	10	—	—	—	26.1	—	49.5	—	—	—	31
		1/4 KGY10-02	14	18.5	17	26.5	29.5	—	50.5	—	—	—	29
		3/8 KGY10-03	17	—	—	—	30.9	—	52	—	—	—	39
		1/2 KGY10-04	22	—	—	—	35.1	—	54.5	—	—	—	66
12	M5 x 0.8	KGY12-M5	7	20.9	17	28.5	—	—	53.5	—	—	—	31
		1/8 KGY12-01	10	—	—	—	30.5	—	53.5	—	—	—	31
		1/4 KGY12-02	14	20.9	17	28.5	31.9	—	55	22	57.4	45.4	41
16	M5 x 0.8	KGY16-M5	7	26.5	20.9	34	—	—	67.5	—	—	—	68
		1/8 KGY16-01	10	—	—	—	36.1	—	67.5	—	—	—	68
		1/4 KGY16-02	14	26.5	20.9	34	40.1	—	67.5	25	81	(81)	112
													116

* Reference dimensions after R thread installation.

Note 1) For the ø16, this dimension refers to the O.D. of the release button.

Note 2) (): Values for soft nylon.

Male Delta Union: KGD

<M5>

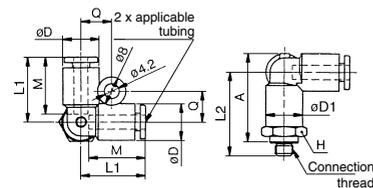

<R>

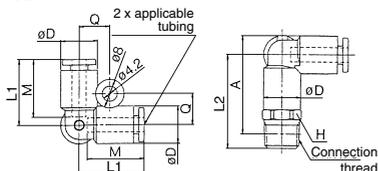

Applicable tubing O.D. (mm)	Connection thread M/R	Model	H (width across flats)	øD	L1	L2	A*	M	Q	Effective area (mm ²)		Weight (g)		
										Nylon	Urethane			
4	M5 x 0.8	KGD04-M5	11	—	—	24	25.5	—	—	—	4.3	4.3	10	
		1/8 KGD04-01	10	10.4	18.5	25.6	27.5	—	16	8.7	6.0	6.0	12	
		1/4 KGD04-02	14	—	—	30	30	—	—	—	—	—	—	21
6	M5 x 0.8	KGD06-M5	13	—	—	26	28.5	—	—	—	4.3	4.3	12	
		1/8 KGD06-01	10	12.8	20.5	28.1	31.5	—	17	9.9	13.9	11.0	21	
		1/4 KGD06-02	14	—	—	32	33	—	—	—	—	—	—	34
		3/8 KGD06-03	17	—	—	33.4	34.5	—	—	—	—	—	—	34
		1/2 KGD06-04	22	—	—	32.6	37	—	—	—	—	—	—	26
8	M5 x 0.8	KGD08-M5	13	15.2	23.5	36	38	—	18.5	11.1	26.3	18.2	35	
		1/8 KGD08-01	10	—	—	36	38	—	—	—	—	—	—	39
		1/4 KGD08-02	14	15.2	23.5	36	38	—	—	—	—	—	—	39
10	M5 x 0.8	KGD10-M5	13	18.5	26.5	39.4	43.5	—	21	12.8	40.8	29.0	40	
		1/8 KGD10-01	10	—	—	39	43	—	—	—	—	—	—	62
		1/4 KGD10-02	14	18.5	26.5	39.4	43.5	—	—	—	—	—	—	62
12	M5 x 0.8	KGD12-M5	13	20.9	28.5	41.5	46.5	—	22	13.9	57.2	45.2	55	
		1/8 KGD12-01	10	—	—	41.9	47	—	—	—	—	—	—	56
		1/4 KGD12-02	14	20.9	28.5	41.5	46.5	—	—	—	—	—	—	63

* Reference dimensions after R thread installation.



Delta Union: KGD

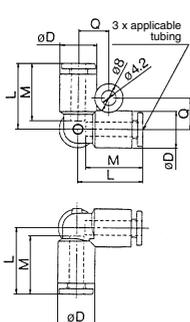

Applicable tubing O.D. (mm)	Model	øD	L	Q	M	Effective area (mm ²)		Weight (g)
						Nylon	Urethane	
4	KGD04-00	10.4	18.5	8.7	16	6.0	4.1	5
6	KGD06-00	12.8	20.5	9.9	17	13.9	11.0	7
8	KGD08-00	15.2	23.5	11.1	18.5	26.3	18.2	11
10	KGD10-00	18.5	26.5	12.8	21	40.8	29.0	19
12	KGD12-00	20.9	28.5	13.9	22	57.2	45.2	24

KQ2

KQB2

KS
KX

KM

KF

M

H/DL
L/LL

KC

KK

KK130

DM

KDM

KB

KR

KA

KQG2

KG

KFG2

MS

KKA

KP

LQ

MQR

T

IDK

Branch "Y": KGU

<M5>

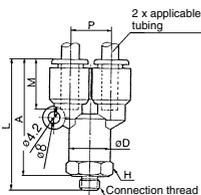

<R>

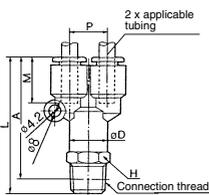

Applicable tubing O.D. (mm)	Connection thread M R	Model	H (width across flats)	øD	L	P	A*	M	Effective area (mm ²)		Weight (g)					
									Nylon	Urethane						
4	M5 x 0.8	KGU04-M5	11	10.4	18.5	10.4	36	16	2.2	2.2	4					
		KGU04-01										41.1	38	4.2	4.2	11
		KGU04-02										45.5	40		20	
6	M5 x 0.8	KGU06-M5	13	12.8	20.5	12.8	39	17	2.2	2.2	12					
		KGU06-01										42.5	43		11	
		KGU06-02										48.5	43		21	
		KGU06-03										49.9	44.5		34	
8	M5 x 0.8	KGU08-01	17	15.2	23.5	15.2	49.5	18.5	25.6	17.7	23					
		KGU08-02										51.6	48.5		15	
		KGU08-03										55.4	50		35	
10	M5 x 0.8	KGU10-02	19	18.5	26.5	18.5	55.5	21	40	28.4	40					
		KGU10-03										60.5	55		65	
		KGU10-04										64.1	57		65	
12	M5 x 0.8	KGU12-02	22	20.9	28.5	20.9	64	22	57.4	45.4	40					
		KGU12-03										64	58.5		65	
		KGU12-04										67.6	60.5		65	

* Reference dimensions after R thread installation.

Delta Branch: KGUD

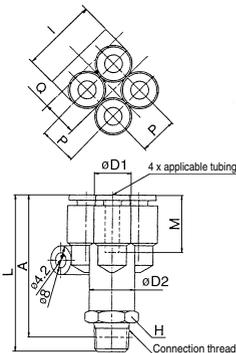

Applicable tubing O.D. (mm)	Connection thread R thread	Model	H (width across flats)	øD1	øD2	L	I	A*	Q	M	P	Effective area (mm ²)		Weight (g)
												Nylon	Urethane	
4	1/8	KGUD04-01	13	10.4	12.8	42.6	21	39.5	9.7	16	10.4	4.2	4.2	17
		KGUD04-02												
6	1/8	KGUD06-01	17	12.8	15.2	49.6	26	46.5	11.7	17	12.8	13.4	10.6	29
		KGUD06-02												

* Reference dimensions after R thread installation.

KG Series



Union "Y": KGU

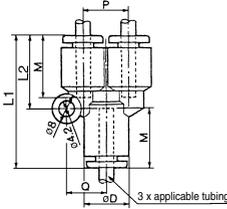

Applicable tubing O.D. (mm)	Model	ϕD	L1	L2	P	Q	M	Effective area (mm ²)		Weight (g)	
								Nylon	Urethane		
4	6	KGU04-00	10.4	34	18	10.4	9.7	16	4.2	4.2	7
6	6	KGU06-00	12.8	37	20	12.8	11.7	17	13.4	10.6	9
8	8	KGU08-00	15.2	42.5	24.5	15.2	13.7	18.5	25.6	17.7	11
10	10	KGU10-00	18.5	48	27.5	18.5	16.1	21	40	28.4	16
12	12	KGU12-00	20.9	51	30	20.9	18.1	22	57.4	45.4	23



Different Diameter Union "Y": KGU

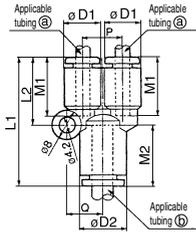

Applicable tubing O.D. (mm)		Model	$\phi D1$	$\phi D2$	L1	L2	P	Q	M1	M2	Effective area (mm ²)		Weight (g)
(a)	(b)										Nylon	Urethane	
4	6	KGU04-06	10.4	12.8	35	18	10.4	9.7	16	17	4.2	4.2	6
6	8	KGU06-08	12.8	15.2	39.5	20	12.8	11.7	17	18.5	13.4	10.6	11
8	10	KGU08-10	15.2	18.5	45	24.5	15.2	13.7	18.5	21	25.6	17.7	18
10	12	KGU10-12	18.5	20.9	49	27.5	18.5	16.1	21	22	40	28.4	27



Different Diameter Double Union "Y": KGD

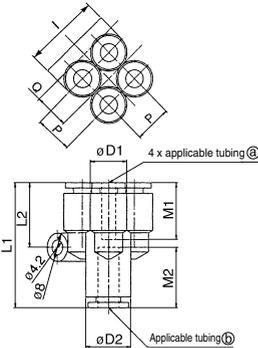

Applicable tubing O.D. (mm)		Model	$\phi D1$	$\phi D2$	L1	L2	P	I	Q	M1	M2	Effective area (mm ²)		Weight (g)
(a)	(b)											Nylon	Urethane	
4	6	KGD04-06	10.4	12.8	35.5	18.2	10.4	21	9.7	16	17	4.2	4.2	10
6	8	KGD06-08	12.8	15.2	40.5	20.3	12.8	26	11.7	17	18.5	13.4	10.6	17

Plug-in Reducer: KGR

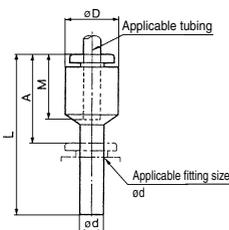

Applicable tubing O.D. (mm)	Applicable fitting size ϕd	Model	ϕD	L	A	M	Effective area (mm ²) ^(Note)		Weight (g)
							Nylon	Urethane	
4	6	KGR04-06	10.4	34.5	17.5	16	5.6	4	1.8
	8	KGR04-08		36.5	18				2.0
	10	KGR04-10		39.5	18.5				3.3
6	4	KGR06-04	12.8	37	21	17	13.1	10.4	4
	8	KGR06-08		37	18.5				2.5
	10	KGR06-10		39.5	20				3
	12	KGR06-12		42	20				4.7
8	10	KGR08-10	15.2	41	20	18.5	26.1	18.0	4.0
	12	KGR08-12		42	20				4.6
	16	KGR08-16		50.5	25.5				4.6
10	12	KGR10-12	18.5	44.5	23	21	41.5	32.8 (29.5)	33
	16	KGR10-16		50.5	25.5				42
	22	KGR10-22		57.4	25.5				42
12	16	KGR12-16	20.9	50.5	25.5	22	58.3	(46.1)	37

(Note) (): Values for soft nylon.



Bulkhead Union: KGE

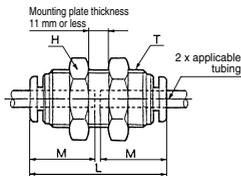

Applicable tubing O.D. (mm)	Model	T(M)	H (width across flats)	L	Mounting hole	M	Effective area (mm ²) ^(Note)		Weight (g)
							Nylon	Urethane	
4	KGE04-00	M12 x 1	14	32.5	13	16	5.6	4	26
6	KGE06-00	M14 x 1	17	34.5	15	17	13.1	10.4	33
8	KGE08-00	M16 x 1	19	38	17	18.5	26.1	18.0	52
10	KGE10-00	M20 x 1	24	42.5	21	21	41.5	29.5	70
12	KGE12-00	M22 x 1	27	44	23	22	58.3	46.1	90
16	KGE16-00	M28 x 1.5	32	51	29	25	113	(96)	115

(Note) (): Values for soft nylon.

Bulkhead Connector: KGE

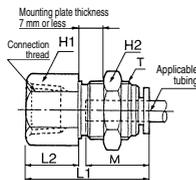

Applicable tubing O.D. (mm)	Connection thread Rc thread	Model	T(M)	H1 (width across flats)	H2 (width across flats)	L1	L2	Mounting hole	M	Effective area (mm ²) ^(Note)		Weight (g)			
										Nylon	Urethane				
4	1/8	KGE04-01	M12 x 1	14	14	27.5	11	13	16	5.6	4	16			
	1/4	KGE04-02		17	31	15	35								
6	1/8	KGE06-01	M14 x 1	17	17	31.5	15	15	17	13.1	10.4	30			
	1/4	KGE06-02											28	11	
	3/8	KGE06-03											19	33.5	17
8	1/8	KGE08-01	M16 x 1	17	19	27.5	7.5	17	18.5	26.1	18.0	28			
	1/4	KGE08-02											33	13	27
	3/8	KGE08-03											19	35	15
10	1/4	KGE10-02	M20 x 1	22	24	34.5	12.5	21	21	41.5	29.5	53			
	3/8	KGE10-03											36.5	14	67
12	3/8	KGE12-03	M22 x 1	24	27	37	14	23	22	58.3	46.1	92			
	1/2	KGE12-04											41	18	59
16	3/8	KGE16-03	M28 x 1.5	30	32	40	14	29	25	96	(96)	127			
	1/2	KGE16-04								44			18	132	

(Note) (): Values for soft nylon.

Tube Cap: KGC

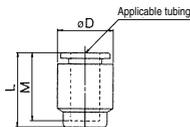

Applicable tubing O.D. (mm)	Model	(Note) øD	L	M	Weight (g)
4	KGC04-00	10.4	17	16	3
6	KGC06-00	12.8	18.5	17	3
8	KGC08-00	15.2	20.5	18.5	4
10	KGC10-00	18.5	23	21	6
12	KGC12-00	20.9	24	22	8
16	KGC16-00	26.5	28	25	13

(Note) For the ø16, this dimension refers to the O.D. of the release button.

KQ2

KQB2

KS
KX

KM

KF

M

H/DL
L/LL

KC

KK

KK130

DM

KDM

KB

KR

KA

KQG2

KG

KFG2

MS

KKA

KP

LQ

MQR

T

IDK



1 Grease-free Specifications

Symbol	Specifications
X17	Grease-free Rubber material: NBR (With fluorine coating) Release button color: Light blue
X39	Grease-free Rubber material: NBR (With fluorine coating) Release button color: Light blue Clean (Air blow, double package)
X94	Grease-free Rubber material: FKM (With fluorine coating) Release button color: Light blue

Suffix "-X17" to the end of part number.

Example) **KGH06-01-X17**

2 Other Specifications

Symbol	Specifications
X12	Lubricant: White Vaseline Release button color: White
X34	Rubber material: FKM

Spare Parts

Description	Part no.	Applicable thread	Applicable model
Gasket	M-5G2	M5	—
	KG04-P01	—	KGE04-00, KGE04-01, KGE04-02
Pipe nut	KG06-P01	—	KGE06-00, KGE06-01 KGE06-02, KGE06-03
	KG08-P01	—	KGE08-00, KGE08-01 KGE08-02, KGE08-03
	KG10-P01	—	KGE10-00, KGE10-02, KGE10-03
	KG12-P01	—	KGE12-00, KGE12-03, KGE12-04
	KG16-P01	—	KGE16-00, KGE16-03, KGE16-04