

3 Port Solenoid Valve

VV100 Series

Highly Integrated Unit Manifold



2 direct-operated 3-port valves on 1 station

Connector
(For plug-in connection)

Individually wired valve can be added.

Ø2 One-touch fitting connection is possible.

SUP/EXH block fittings

- Fitting entry direction
 - Standard (Same direction as the cylinder entry ports)
 - Side

D-sub connector

Number of connectors: 15 pins, 26 pins (for plug-in connection)

- Connector entry direction
 - Upward
 - Lateral

Plug-in Connector type manifold

Non Plug-in Individual wiring manifold

Compact manifold with two 3-port valves on 1 station

Scale: 100%



L: Dimensions

| Stations | 1 | 2 | 3 | 4 | 5 | 6 | 7 | 8 | 9 | 10 | 11 | 12 |
|----------|------|------|------|------|----|------|------|-------|-------|-----|-------|-------|
| L | 34.2 | 44.4 | 54.6 | 64.8 | 75 | 85.2 | 95.4 | 105.6 | 115.8 | 126 | 136.2 | 146.4 |

Mounting

Direct mounting

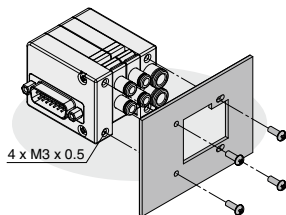

Bracket mounting

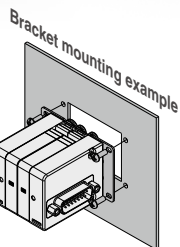
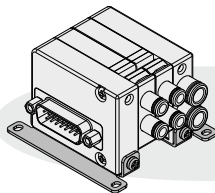

Piping Variations

- Metric size: $\phi 2$, $\phi 4$ One-touch fitting
- Inch size: $\phi 1/8$ ", $\phi 5/32$ " One-touch fitting

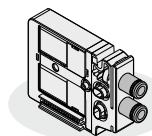

Straight fitting

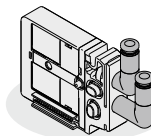

Elbow fitting
(Upward entry)

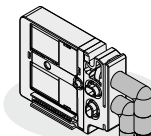

Elbow fitting
(Downward entry)

With Switch

Possible to shut the signal of each valves individually.

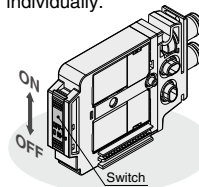

- The valve coil is not energized even if an electric signal is fed by the manifold's connector.
- Effective use as a safety measure for maintenance.

Applications

- 1 Operating a small bore size cylinder such as a pin cylinder
- 2 Air-operated valve for chemical valve



I N D E X

| | |
|-----------------------------|--------|
| Common Specifications | P.1142 |
| Construction | P.1143 |

Plug-in Connector Type Manifold



| | |
|----------------------------------|----------------|
| How to Order | P.1144, 1145 |
| Manifold Electrical Wiring | P.1146 |
| Connector Wiring Diagram | P.1146 |
| Dimensions | P.1147 to 1151 |

Non Plug-in Individual Wiring Manifold



| | |
|--------------------|--------------|
| How to Order | P.1152, 1153 |
| Dimensions | P.1154, 1155 |

| | |
|------------------------------------|----------------|
| Manifold Exploded View | P.1156 |
| Manifold Options | P.1157 to 1159 |
| Specific Product Precautions | P.1160 to 1164 |

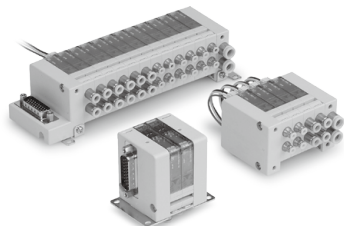

Manifold Specifications

| Model | | D-sub connector | | Non plug-in |
|---|--|---|-------------------------|-------------------|
| | | Type 10FA | Type 10FB | Type 10 |
| Manifold type | | Connector type | | Individual wiring |
| 1 (SUP), 3 (EXH) | | Common SUP, EXH | | |
| Valve stations | | 1 to 12 stations (Max. 7 stations if all valves have double solenoid.) | 1 to 12 stations | 1 to 12 stations |
| Applicable connector | | D-sub connector 15 pins | D-sub connector 26 pins | |
| | | Refer to page 1159. | | |
| Internal wiring | | Non-polar, +COM., -COM. Valve +COM, -COM. | | |
| 2a, 2b port piping specification | | Location Valve | | |
| | | Direction Side, Upward, Downward (Using elbow fittings for upward or downward) | | |
| Port size | | 1 (SUP), 3 (EXH) port ^{Note 1)} C4, C6, N3, N7 | | |
| 2a, 2b port | | C2, C4, N1, N3 | | |
| Weight W (g) | | n: Valve stations ^{Note 2)} W = 56 + n | | |

Note 1) Supply to 3 port and exhaust from 1 port for V120 type (N.O.).

Note 2) The weight W is the value for the manifold only. (It is applied when the SUP/EXH block fitting is straight type.)
The weight of solenoid valve should be added by the number of stations.

Solenoid Valve Specifications

| | | | |
|---|---|--|--|
| Fluid | | Air | |
| Operating pressure range (MPa) | Positive pressure | | 0 to 0.7 |
| | Vacuum pressure | N.C. | 1 port: -100 kPa to 0.6/3 ports: -100 kPa to 0 |
| Ambient and fluid temperature (°C) | | -10 to 50 (No freezing) | |
| Maximum operating frequency (Hz) | | 20 | |
| Lubrication | | Not required | |
| Mounting orientation | | Unrestricted | |
| Impact/Vibration resistance (m/s²) ^{Note 1)} | | 150/30 | |
| Enclosure | | Dustproof | |
| Coil rated voltage (DC) | | 24 V, 12 V | |
| Allowable voltage fluctuation (V) | | ±10% of rated voltage ^{Note 2)} | |
| Power consumption (W) | Standard | | 0.4 |
| | With power saving circuit (Continuous duty type) | | 0, 15 ^{Note 3)} [Starting 0.4, Holding 0.15] |
| Surge voltage suppressor | | Diode | |
| Indicator light | | LED | |

Note 1) Impact resistance: No malfunction occurred when it is tested with a drop tester in the axial direction and at the right angles to the main valve and armature in both energized and de-energized states every once for each condition. (Value in the initial state)

Vibration resistance: No malfunction occurred in one sweep test between 45 and 2000Hz. Test was performed in the axial direction and at the right angles to the main valve and armature in both energized and de-energized states for each condition. (Value in the initial state)

Note 2) For the allowable voltage fluctuation for Z and T types (with power saving circuit), observe the following range because there is voltage drop due to internal circuit.

Z type 24 VDC: -7% to +10% T type 24 VDC: -5% to +10%
 12 VDC: -4% to +10% 12 VDC: -6% to +10%

Note 3) Refer to page 1161 for details.

Response Time

| |
|-------------------------------|
| Response time ms (at 0.5 MPa) |
| 7 or less |

Note) Based on dynamic performance test, JIS B 8419: 2010.
(Coil temperature: 20°C, at rated voltage)

Weight

| Valve model | Number of solenoids | Port size | Weight (g) |
|-------------|---------------------|----------------------------|------------|
| V110□-C2/C4 | 1 pc. (Single) | C2, C4 | 31 |
| | 2 pcs. (Double) | (ø2, ø4 One-touch fitting) | 40 |

Flow Rate Characteristics

| Port size | | Flow rate characteristics | | | |
|-----------|--------|------------------------------|------|------------------------------|------|
| 1(P) | 2a, 2b | 1(P)→2a/2b | | 2a/2b→3(E) | |
| | | C [dm ³ /(s·bar)] | b | C [dm ³ /(s·bar)] | b |
| C6 | C2 | 0.03 | 0.22 | 0.05 | 0.31 |
| | C4 | 0.03 | 0.19 | 0.05 | 0.29 |

* The effective area S (mm²) is approximately 5 times as large as the sonic conductance (S = C × 5).

Construction

Single

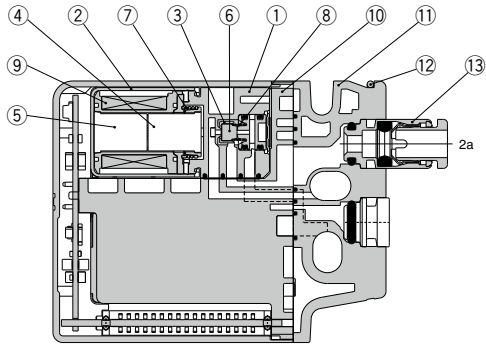
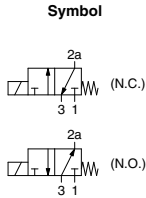

Double

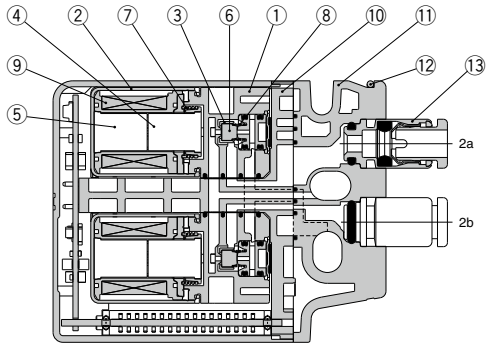
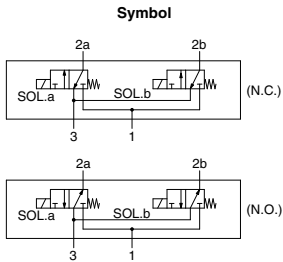

Component Parts

| No. | Description | Material |
|-----|--------------------------|-----------------------|
| 1 | Body | Resin |
| 2 | Cover | Stainless steel |
| 3 | Push rod | Resin |
| 4 | Armature assembly | Stainless steel/Resin |
| 5 | Core | Stainless steel |
| 6 | Poppet | FKM |
| 7 | Return spring | Stainless steel |
| 8 | Poppet spring | Stainless steel |
| 9 | Coil assembly | — |
| 10 | Pilot adapter | Resin |
| 11 | Port block | Resin |
| 12 | Clip | Stainless steel |

Replacement Parts

One-touch Fitting (Metric Size)

| No. | Port | Port size | Part no. |
|-----|------------|-----------------------------------|-----------------|
| 13 | 2a, 2b | ø2 One-touch fitting (Straight) | KJH02-C1 |
| | | ø4 One-touch fitting (Straight) | KJH04-C1 |
| | | ø2 One-touch fitting (Elbow) | KJL02-C1 |
| | | ø4 One-touch fitting (Elbow) | KJL04-C1-N |
| | | ø2 One-touch fitting (Long elbow) | KJW02-C1 |
| | | ø4 One-touch fitting (Long elbow) | KJW04-C1-N |
| | 1(P), 3(E) | ø4 One-touch fitting (Straight) | VVQ1000-50A-C4 |
| | | ø6 One-touch fitting (Straight) | VVQ1000-50A-C6 |
| | | ø4 One-touch fitting (Elbow) | SZ3000-73-1A-L4 |
| | | ø6 One-touch fitting (Elbow) | SZ3000-73-1A-L6 |
| | | ø4 One-touch fitting (Long elbow) | SZ3000-73-2A-L4 |
| | | ø6 One-touch fitting (Long elbow) | SZ3000-73-2A-L6 |

One-touch Fitting (Inch Size)

| No. | Port | Port size | Part no. |
|-----|------------|-------------------------------------|----------------|
| 13 | 2a, 2b | ø1/8" One-touch fitting (Straight) | KJH01-C1 |
| | | ø5/32" One-touch fitting (Straight) | KJH03-C1 |
| | 1(P), 3(E) | ø5/32" One-touch fitting (Straight) | VVQ1000-50A-N3 |
| | | ø1/4" One-touch fitting (Straight) | VVQ1000-50A-N7 |

3 Port Solenoid Valve



VV100 Series/D-sub Connector Plug-in Connector Type Manifold



How to Order Manifold

VV100-10F A D 2 - 05 U 1 - C6

D-sub connector type

| Symbol | Number of poles |
|--------|-----------------|
| A | 15 |
| B | 26 |

Connector block mounting position: D side

Connector entry direction

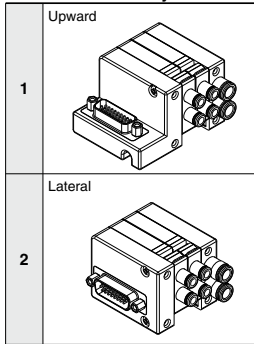

Valve stations

A: D-sub connector 15 pins

| Symbol | Stations | Note |
|--------|-------------|------------------------------|
| 01 | 1 station | Up to 14 solenoids possible. |
| ⋮ | ⋮ | |
| 12 | 12 stations | |

B: D-sub connector 26 pins

| Symbol | Stations | Note |
|--------|-------------|------------------------------|
| 01 | 1 station | Up to 24 solenoids possible. |
| ⋮ | ⋮ | |
| 12 | 12 stations | |

SUP/EXH block mounting position: U side

Mounting option

| Symbol | Mounting |
|---------|-----------------------------------|
| N11 | Manifold direct mounting type |
| Note) N | Manifold direct mounting type |
| F1 | With bracket (Standard) |
| F2 | With bracket (Port downward) |

Note) If the mounting option "N" (Mounting nut: Inch size) is selected, the bracket cannot be mounted.

SUP/EXH block port size

One-touch fitting (Metric size)

| | |
|----|-----------------------------------|
| C4 | ø4 One-touch fitting (Straight) |
| C6 | ø6 One-touch fitting (Straight) |
| L4 | ø4 elbow fitting (Upward entry) |
| L6 | ø6 elbow fitting (Upward entry) |
| B4 | ø4 elbow fitting (Downward entry) |
| B6 | ø6 elbow fitting (Downward entry) |

One-touch fitting (Inch size)

| | |
|----|-------------------------------------|
| N3 | ø5/32" One-touch fitting (Straight) |
| N7 | ø1/4" One-touch fitting (Straight) |

How to Order Valve Manifold Assembly

Ordering example (VV100-10FA)

Double solenoid, individual wiring/lead wire length 300 mm (24 VDC)

V110-D5MZ-C4 (1 set)

Double solenoid (24 VDC)

V110-D5CZJ-C4 (1 set)

Double solenoid (24 VDC)

V110-D5CU-C4 (3 sets)

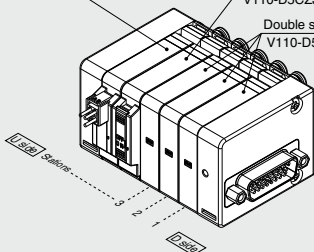

VV100-10FAD2-05U1-C6 1 set (Manifold part no.)

* V110-D5CU-C4 3 sets (Double solenoid part no.)

* V110-D5CZJ-C4 1 set (Double solenoid, with switch part no.)

* V110-D5MZ-C4 1 set (Double solenoid, individual wiring/lead wire length 300 mm part no.)

The asterisk denotes the symbol for assembly. Prefix to the part no. of the solenoid valve, etc.

- The valve arrangement is numbered as the 1st station from D side.
- Indicate the valves to be attached below the manifold part number, in order starting from station 1 as shown in the drawing.

SUP/EXH block fitting entry direction

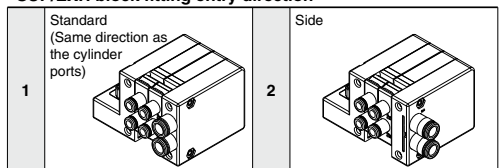

* If the mounted valve is N.O., apply pressure to the 3(E) port and exhaust air from the 1(P) port.



How to Order Valve for Connector Type

Standard

V1 1 0 T - D 5 □ CU - C4 - □

With switch

V1 1 0 - D 5 □ CZ J - C4 - □

Individual wiring
 [For plug-in mixed mounting] ^(Note)

V1 1 0 T - D 5 □ MZ - C4

(Note) See page 1153 for the dedicated non plug-in individual wiring.

Type of actuation

| | |
|---|------------------------|
| 1 | Normally closed (N.C.) |
| 2 | Normally open (N.O.) |

* Normally closed and normally open type cannot be mounted on the same manifold. Refer to "Manifold Specifications" on page 1142 for the pressure port.

Coil specification

| | |
|-----|--|
| NII | Standard |
| T | With power saving circuit (Continuous duty type) |

* Be certain to select "with power saving circuit" when the solenoid valve will be energized continuously for long periods of time.

Number of solenoids

| Symbol | Specifications |
|--------|--------------------------|
| S | 1 pc. (Single solenoid) |
| D | 2 pcs. (Double solenoid) |

Rated voltage

| | |
|---|--------|
| 5 | 24 VDC |
| 6 | 12 VDC |

Common specification

| | |
|-----|-------|
| NII | +COM. |
| N | -COM. |

* For the non-polar type, there is no need to select a symbol.

Connector entry

C: Dedicated for centralized wiring

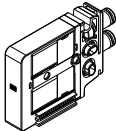

M: Individual wiring, With lead wire
 Length 300 mm

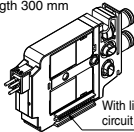

With linkage printed circuit board

MN: Individual wiring, Without lead wire
 (With connector, socket)

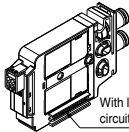

With linkage printed circuit board

MO: Individual wiring, Without connector

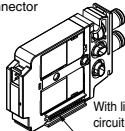

With linkage printed circuit board

* Connector entries with the symbol "M□" cannot use the switch signal from the D-sub connector on the manifold.
 For details, refer to Manifold Electrical Wiring on page 1146.

* When ordering a connector assembly separately, see pages 1163 and 1164.

Light/Surge voltage suppressor

| | |
|---|--|
| U | With light/surge voltage suppressor (Non-polar type) |
| Z | With light/surge voltage suppressor (Polar type) |

* When the types with power saving circuit, with switches, and individual wiring are used, the non-polar type cannot be selected.

With switch

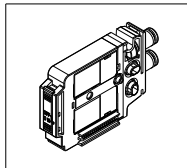

Single solenoid wiring specification

| | |
|-----|---------------|
| NII | Single wiring |
| D | Double wiring |

* Nil for the double solenoid. Select this when the unused numbers to wiring are set. See page 1146 for details.

2a/2b fitting port size

Straight fitting

(Metric size)

C2: ø2 One-touch fitting

C4: ø4 One-touch fitting

(Inch size)

N1: ø1/8" One-touch fitting

N3: ø5/32" One-touch fitting

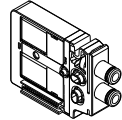

Elbow fitting (Upward entry)

(Metric size)

L2: ø2 One-touch fitting

L4: ø4 One-touch fitting

(Inch size)

LN1: ø1/8" One-touch fitting

LN3: ø5/32" One-touch fitting

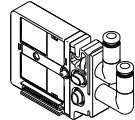

Elbow fitting (Downward entry)

(Metric size)

B2: ø2 One-touch fitting

B4: ø4 One-touch fitting

(Inch size)

BN1: ø1/8" One-touch fitting

BN3: ø5/32" One-touch fitting

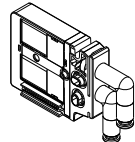

VV100 Series

Manifold Electrical Wiring (Image)

When a valve is added, the signals of the connector are assigned to the valve. This makes it completely unnecessary to disassemble the connector unit.

* The connector arrangement shown below differs from the actual arrangement. Refer to the Connector Wiring Diagram below.

Single Solenoid and Double Solenoid

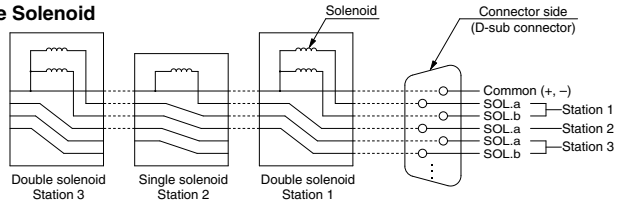

Single Solenoid with Double Wiring Specification

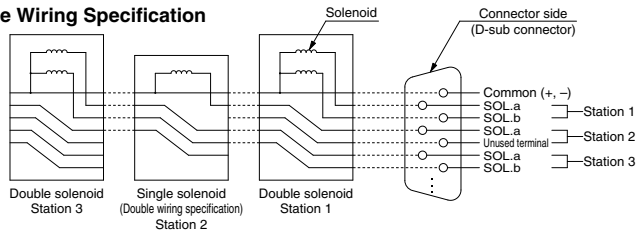

Individually Wired Valve

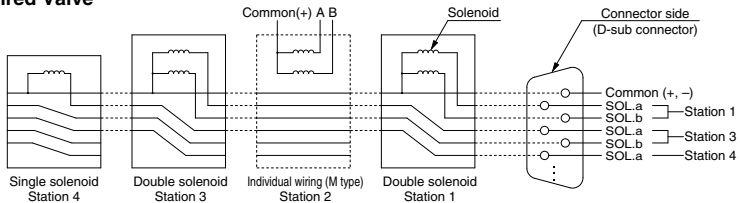

Connector Wiring Diagram

Type FA: D-sub connector (15 pins)

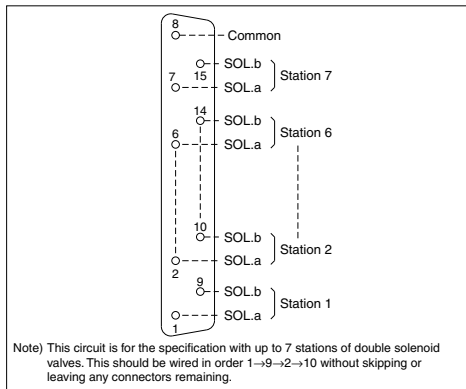

Type FB: D-sub connector (26 pins)

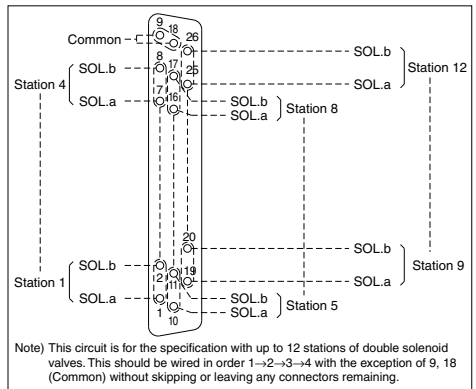

Caution

When the non-polar U type valves are used, either +COM or -COM wiring of the manifold is possible. However when Z type valves are used, select the common specifications, +COM or -COM.

3 Port Solenoid Valve/D-sub Connector

Plug-in Connector Type Manifold **VV100 Series**

Dimensions

VV100-10F $\frac{1}{4}$ D1 - Stations U $\frac{1}{2}$ □□

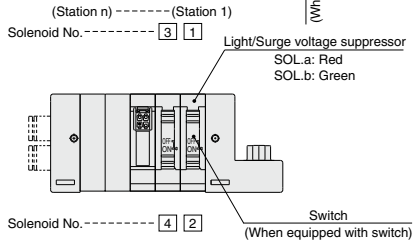
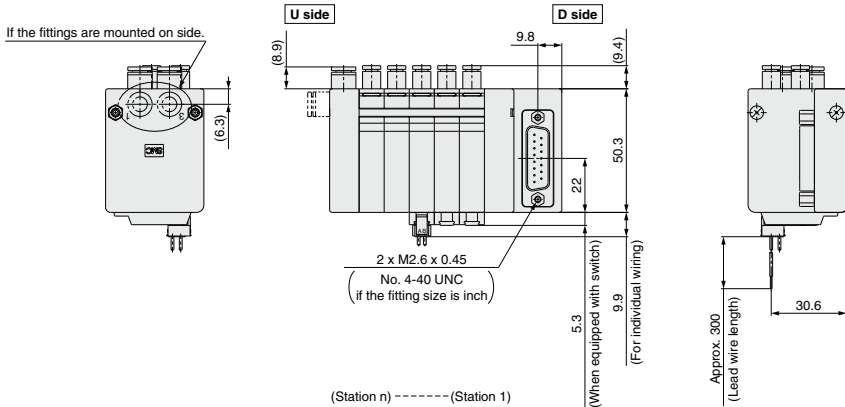
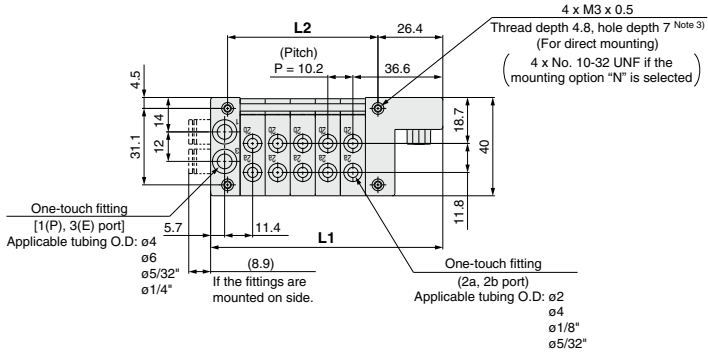

- Note 1) 10FA and 10FB types have the same L1 and L2 dimensions, and the only difference is the number of poles of the connector. See page 1146 for the pin arrangement.
- Note 2) For manifold dimensions including elbow fitting, see page 1151.
- Note 3) As the distance between the block end to the thread is 2.5 mm, the screw depth should be 5 to 7 mm.

L: Dimensions

| L | n: Stations | | | | | | | | | | | |
|----|-------------|------|------|------|------|-------|-------|-------|-------|-------|-------|-------|
| | 1 | 2 | 3 | 4 | 5 | 6 | 7 | 8 | 9 | 10 | 11 | 12 |
| L1 | 53.7 | 63.9 | 74.1 | 84.3 | 94.5 | 104.7 | 114.9 | 125.1 | 135.3 | 145.5 | 155.7 | 165.9 |
| L2 | 20.4 | 30.6 | 40.8 | 51 | 61.2 | 71.4 | 81.6 | 91.8 | 102 | 112.2 | 122.4 | 132.6 |

VV100 Series

Dimensions

VV100-10F¹D1 - Stations U₂ - □ □ F₂

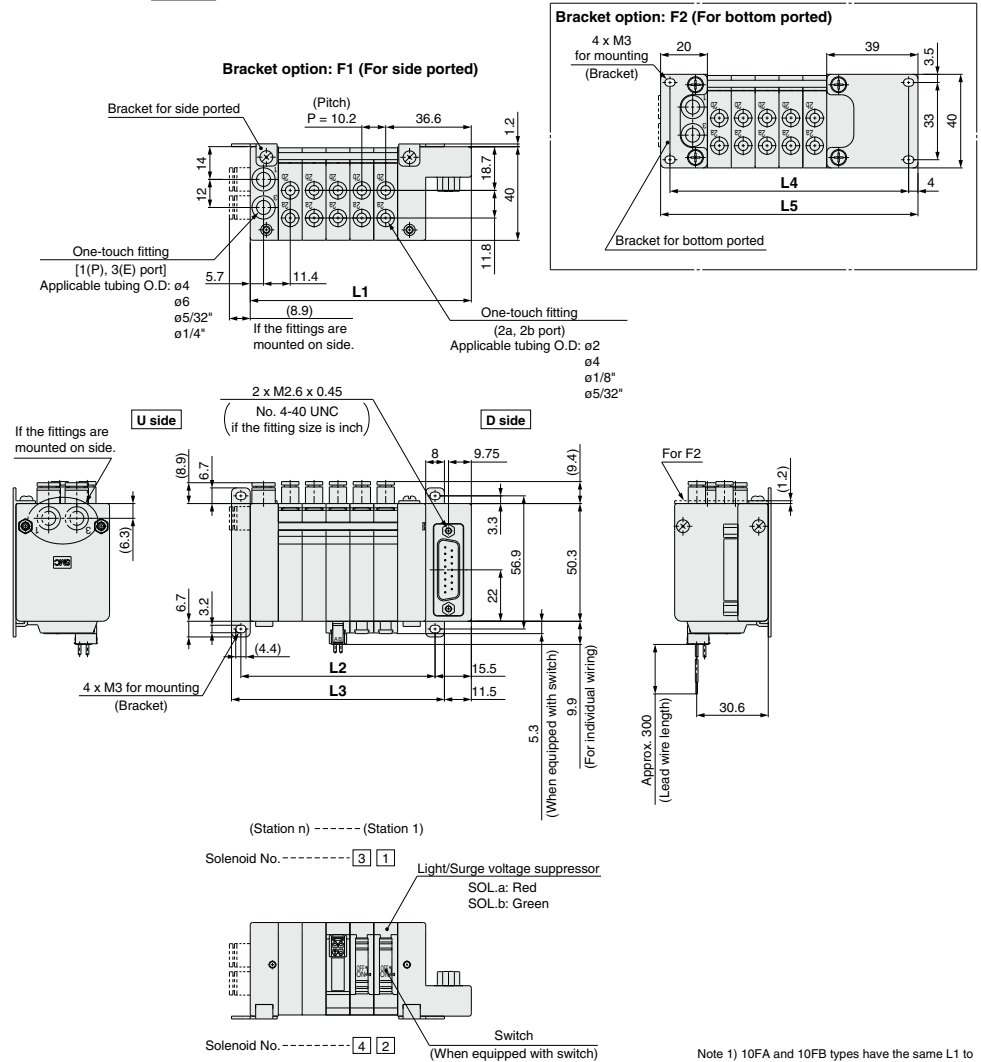

Note 1) 10FA and 10FB types have the same L1 to L5 dimensions, and the only difference is the number of poles of the connector. See page 1146 for the pin arrangement.

Note 2) For manifold dimensions including elbow fitting, see page 1151.

L: Dimensions

| | | n: Stations | | | | | | | | | | | |
|----|---|-------------|------|------|------|-------|-------|-------|-------|-------|-------|-------|-------|
| L | n | 1 | 2 | 3 | 4 | 5 | 6 | 7 | 8 | 9 | 10 | 11 | 12 |
| L1 | | 53.7 | 63.9 | 74.1 | 84.3 | 94.5 | 104.7 | 114.9 | 125.1 | 135.3 | 145.5 | 155.7 | 165.9 |
| L2 | | 42.2 | 52.4 | 62.6 | 72.8 | 83 | 93.2 | 103.4 | 113.6 | 123.8 | 134 | 144.2 | 154.4 |
| L3 | | 50.2 | 60.4 | 70.6 | 80.8 | 91 | 101.2 | 111.4 | 121.6 | 131.8 | 142 | 152.2 | 162.4 |
| L4 | | 61.2 | 71.4 | 81.6 | 91.8 | 102 | 112.2 | 122.4 | 132.6 | 142.8 | 153 | 163.2 | 173.4 |
| L5 | | 68.6 | 78.8 | 89 | 99.2 | 109.4 | 119.6 | 129.8 | 140 | 150.2 | 160.4 | 170.6 | 180.8 |

3 Port Solenoid Valve/D-sub Connector

Plug-in Connector Type Manifold **VV100 Series**

VV100-10F[▲]D2-**Stations** U₂-□□

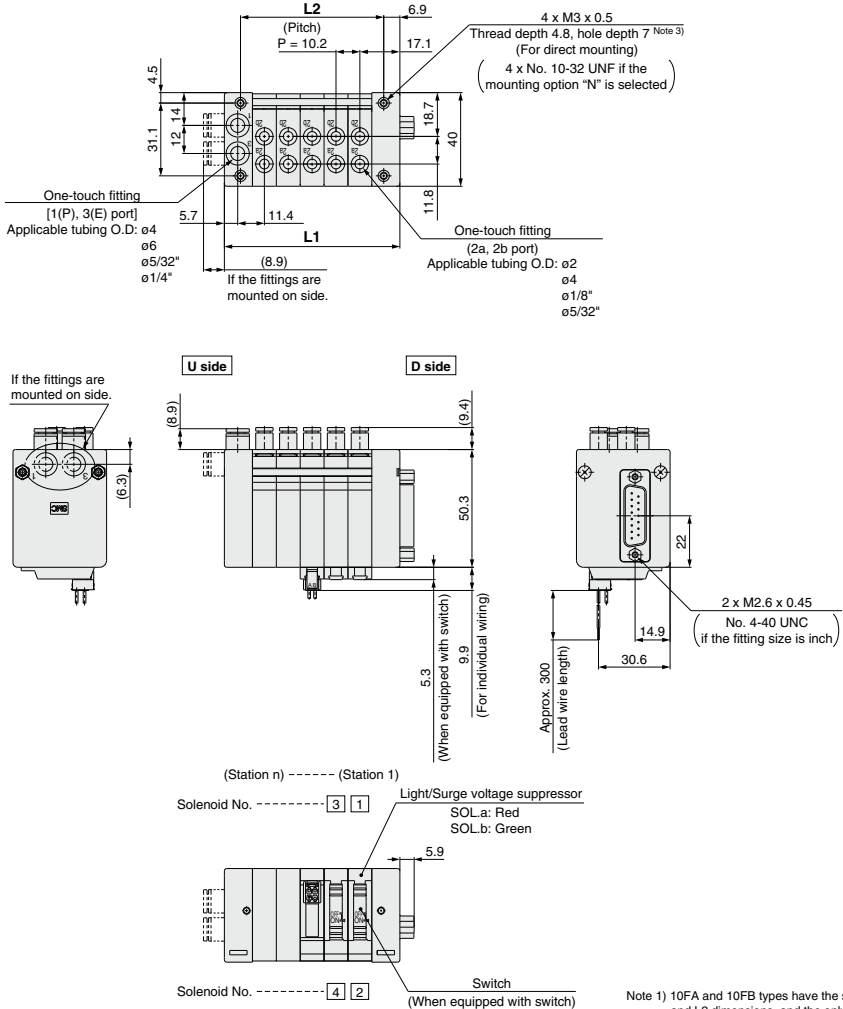

- Note 1) 10FA and 10FB types have the same L1 and L2 dimensions, and the only difference is the number of poles of the connector. See page 1146 for the pin arrangement.
- Note 2) For manifold dimensions including elbow fitting, see page 1156.
- Note 3) As the distance between the block end to the thread is 2.5 mm, the screw depth should be 5 to 7 mm.

L: Dimensions

| L | n | n: Stations | | | | | | | | | | | |
|----|---|-------------|------|------|------|------|------|------|-------|-------|-------|-------|-------|
| | | 1 | 2 | 3 | 4 | 5 | 6 | 7 | 8 | 9 | 10 | 11 | 12 |
| L1 | | 34.2 | 44.4 | 54.6 | 64.8 | 75 | 85.2 | 95.4 | 105.6 | 115.8 | 126 | 136.2 | 146.4 |
| L2 | | 20.4 | 30.6 | 40.8 | 51 | 61.2 | 71.4 | 81.6 | 91.8 | 102 | 112.2 | 122.4 | 132.6 |

VV100 Series

Dimensions

VV100-10F¹ D2 - Stations U₂ - □ □ F₁

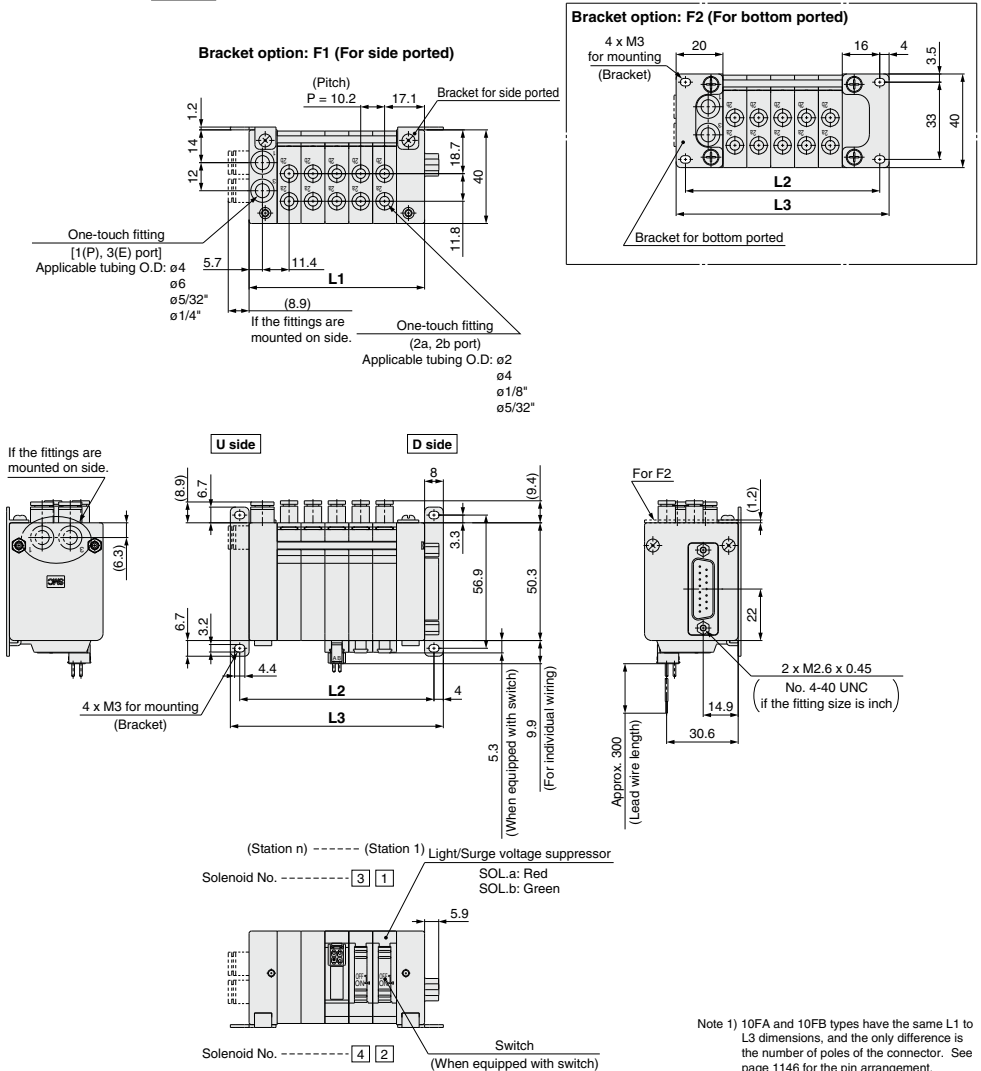

Note 1) 10FA and 10FB types have the same L1 to L3 dimensions, and the only difference is the number of poles of the connector. See page 1146 for the pin arrangement.

Note 2) For manifold dimensions including elbow fitting, see page 1151.

L: Dimensions

| L | n: Stations | | | | | | | | | | | |
|----|-------------|------|------|------|----|-------|-------|-------|-------|-----|-------|-------|
| | 1 | 2 | 3 | 4 | 5 | 6 | 7 | 8 | 9 | 10 | 11 | 12 |
| L1 | 34.2 | 44.4 | 54.6 | 64.8 | 75 | 85.2 | 95.4 | 105.6 | 115.8 | 126 | 136.2 | 146.4 |
| L2 | 42.2 | 52.4 | 62.6 | 72.8 | 83 | 93.2 | 103.4 | 113.6 | 123.8 | 134 | 144.2 | 154.4 |
| L3 | 50.2 | 60.4 | 70.6 | 80.8 | 91 | 101.2 | 111.4 | 121.6 | 131.8 | 142 | 152.2 | 162.4 |

3 Port Solenoid Valve/D-sub Connector

Plug-in Connector Type Manifold **VV100 Series**

VV100-10FAD2- [Stations] U₂- $\frac{1}{2}$

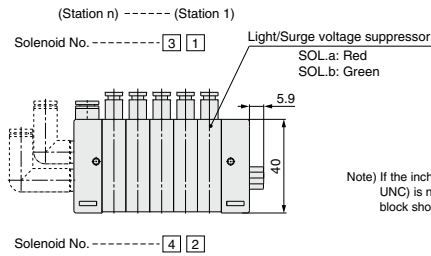
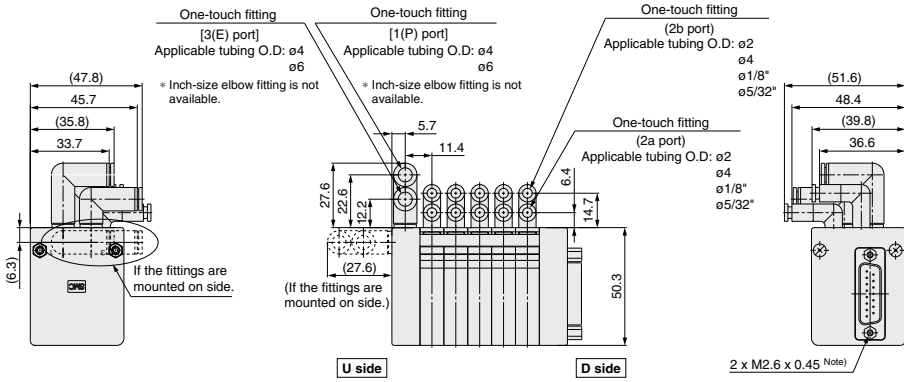
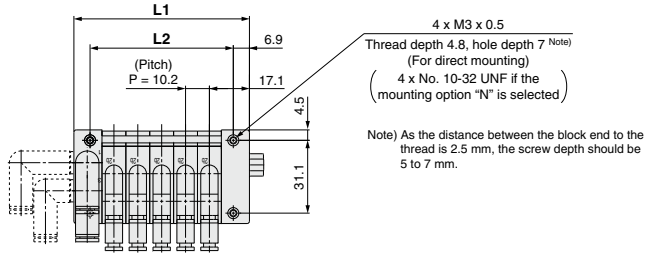

Note) If the inch-size lock bracket screw (No. 4-40 UNC) is needed, the port size of air SUP/EXH block should also be inch size (straight only).

Downward (Type B)

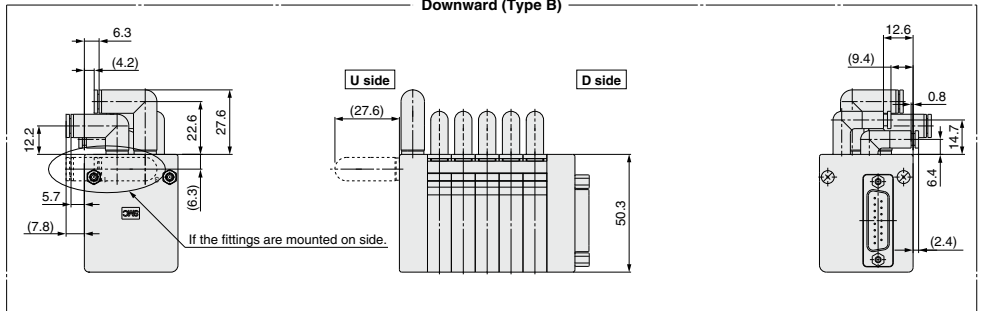

3 Port Solenoid Valve



VV100 Series

Non Plug-in Individual Wiring Manifold



How to Order Manifold

VV100-10-05U1-C6

Valve stations

| Symbol | Stations |
|--------|-------------|
| 01 | 1 station |
| ⋮ | ⋮ |
| 12 | 12 stations |

SUP/EXH block mounting position: U side

SUP/EXH block fitting entry direction

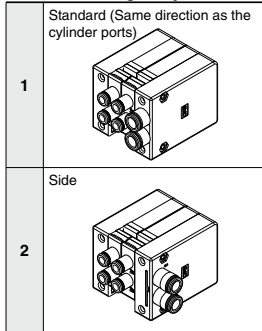

Note) If the mounted valve is N.O., apply pressure to the 3(E) port and exhaust air from the 1(P) port.

Mounting option

| Symbol | Mounting |
|----------|-----------------------------------|
| N11 | Manifold direct mounting type |
| N (Note) | Manifold direct mounting type |
| F1 | With bracket (Standard) |
| F2 | With bracket (Port downward) |

Note) If the mounting option "N" (Mounting nut: Inch size) is selected, the bracket cannot be mounted.

SUP/EXH block port size

One-touch fitting (Metric size)

| | |
|----|-----------------------------------|
| C4 | ø4 One-touch fitting (Straight) |
| C6 | ø6 One-touch fitting (Straight) |
| L4 | ø4 elbow fitting (Upward entry) |
| L6 | ø6 elbow fitting (Upward entry) |
| B4 | ø4 elbow fitting (Downward entry) |
| B6 | ø6 elbow fitting (Downward entry) |

One-touch fitting (Inch size)

| | |
|----|-------------------------------------|
| N3 | ø5/32" One-touch fitting (Straight) |
| N7 | ø1/4" One-touch fitting (Straight) |

How to Order Valve Manifold Assembly

Ordering example (VV100-10-□)

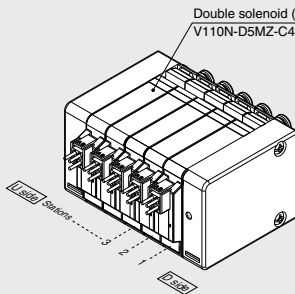

VV100-10-05U1-C6 1 set (Manifold part no.)
 * V110N-D5MZ-C4 5 sets (Double solenoid part no.)
 * The asterisk denotes the symbol for assembly.
 Prefix to the part no. of the solenoid valve, etc.

- The valve arrangement is numbered as the 1st station from D side.
- Indicate the valves to be attached below the manifold part number, in order starting from station 1 as shown in the drawing.



How to Order Valve Dedicated for Non Plug-in Individual Wiring

V110TN-D5 MZ-C4

Type of actuation

| | |
|---|------------------------|
| 1 | Normally closed (N.C.) |
| 2 | Normally open (N.O.) |

* Normally closed and normally open type cannot be mounted on the same manifold.

Coil specification

| | |
|-----|--|
| Nil | Standard |
| T | With power saving circuit (Continuous duty type) |

* Be certain to select "with power saving circuit" when the solenoid valve will be energized continuously for long periods of time.

Non plug-in

Number of solenoids

| Symbol | Specifications |
|--------|--------------------------|
| S | 1 pc. (Single solenoid) |
| D | 2 pcs. (Double solenoid) |

Rated voltage

| | |
|---|--------|
| 5 | 24 VDC |
| 6 | 12 VDC |

Common specification

| | |
|-----|-------|
| Nil | +COM. |
| N | -COM. |

Connector entry

M: Individual wiring, With lead wire
Length 300 mm

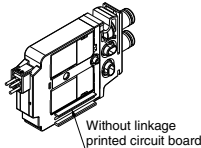

MN: Individual wiring, Without lead wire
(With connector, socket)

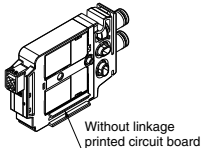

MO: Individual wiring, Without connector

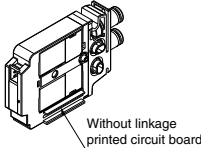

* When ordering a connector assembly separately, see pages 1163 and 1164.

2a/2b fitting port size

Straight fitting
(Metric size)

C2: ø2 One-touch fitting

C4: ø4 One-touch fitting

(Inch size)

N1: ø1/8" One-touch fitting

N3: ø5/32" One-touch fitting

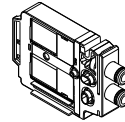

Elbow fitting (Upward entry)
(Metric size)

L2: ø2 One-touch fitting

L4: ø4 One-touch fitting

(Inch size)

LN1: ø1/8" One-touch fitting

LN3: ø5/32" One-touch fitting

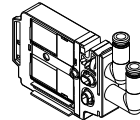

Elbow fitting (Downward entry)
(Metric size)

B2: ø2 One-touch fitting

B4: ø4 One-touch fitting

(Inch size)

BN1: ø1/8" One-touch fitting

BN3: ø5/32" One-touch fitting

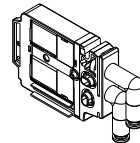

Light/Surge voltage suppressor

Z With light/surge voltage suppressor

VV100 Series

Dimensions

VV100-10-**Stations** U₁-□□

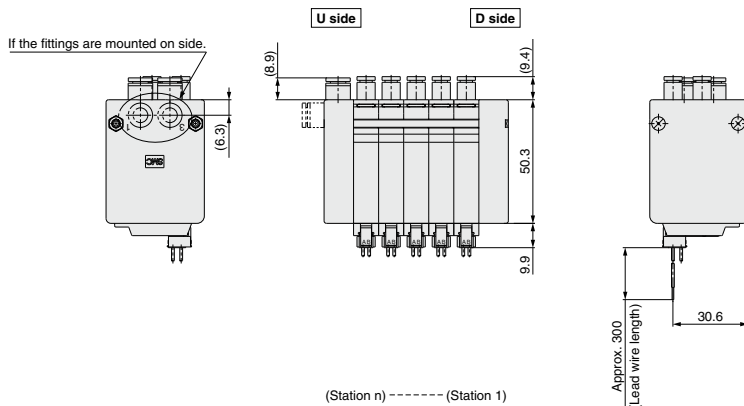
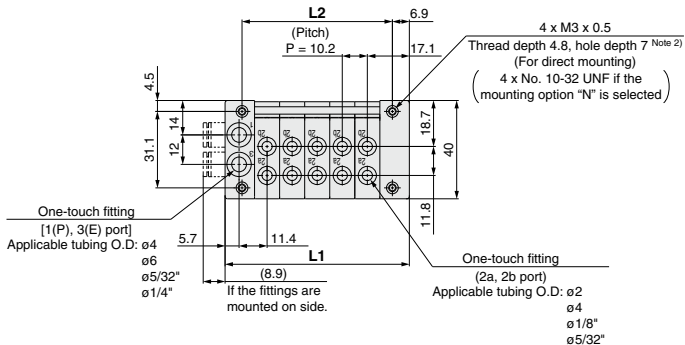

(Station n) ----- (Station 1)
Solenoid No. ----- 3 1

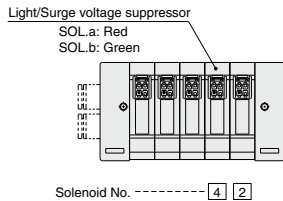

Note 1) For manifold dimensions including elbow fitting, see page 1151.

Note 2) As the distance between the block end to the thread is 2.5 mm, the screw depth should be 5 to 7 mm.

L: Dimensions

| L | n: Stations | | | | | | | | | | | |
|----|-------------|------|------|------|------|------|------|-------|-------|-------|-------|-------|
| | 1 | 2 | 3 | 4 | 5 | 6 | 7 | 8 | 9 | 10 | 11 | 12 |
| L1 | 34.2 | 44.4 | 54.6 | 64.8 | 75 | 85.2 | 95.4 | 105.6 | 115.8 | 126 | 136.2 | 146.4 |
| L2 | 20.4 | 30.6 | 40.8 | 51 | 61.2 | 71.4 | 81.6 | 91.8 | 102 | 112.2 | 122.4 | 132.6 |

3 Port Solenoid Valve Non Plug-in Individual Wiring Manifold **VV100 Series**

VV100-10-**Stations** U₁-□□ F₂

Bracket option: F1 (For side ported)

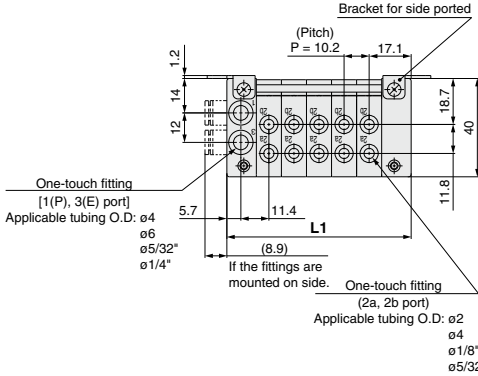

Bracket option: F2 (For bottom ported)

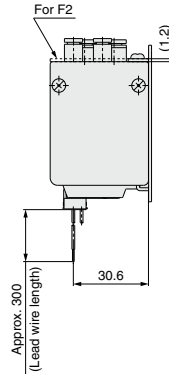
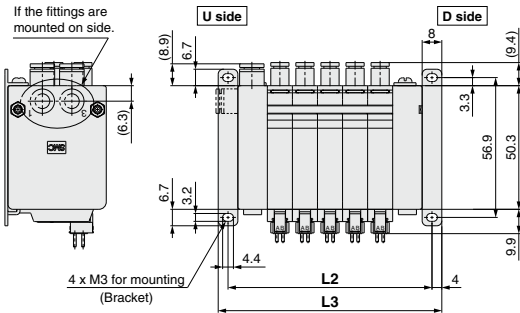
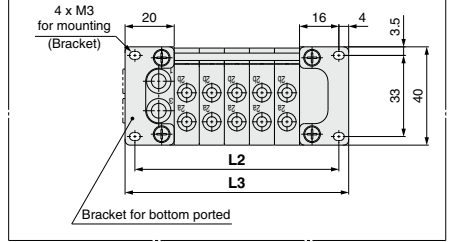

(Station n) ----- (Station 1)

Solenoid No. ----- 3 1

Light/Surge voltage suppressor

SOL.a: Red
SOL.b: Green

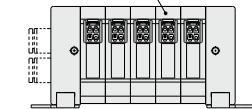

Solenoid No. ----- 4 2

Note) For manifold dimensions including elbow fitting, see page 1151.

L: Dimensions

| | | n: Stations | | | | | | | | | | | |
|----|---|-------------|------|------|------|----|-------|-------|-------|-------|-----|-------|-------|
| L | n | 1 | 2 | 3 | 4 | 5 | 6 | 7 | 8 | 9 | 10 | 11 | 12 |
| L1 | | 34.2 | 44.4 | 54.6 | 64.8 | 75 | 85.2 | 95.4 | 105.6 | 115.8 | 126 | 136.2 | 146.4 |
| L2 | | 42.2 | 52.4 | 62.6 | 72.8 | 83 | 93.2 | 103.4 | 113.6 | 123.8 | 134 | 144.2 | 154.4 |
| L3 | | 50.2 | 60.4 | 70.6 | 80.8 | 91 | 101.2 | 111.4 | 121.6 | 131.8 | 142 | 152.2 | 162.4 |

VV100 Series

Manifold Exploded View

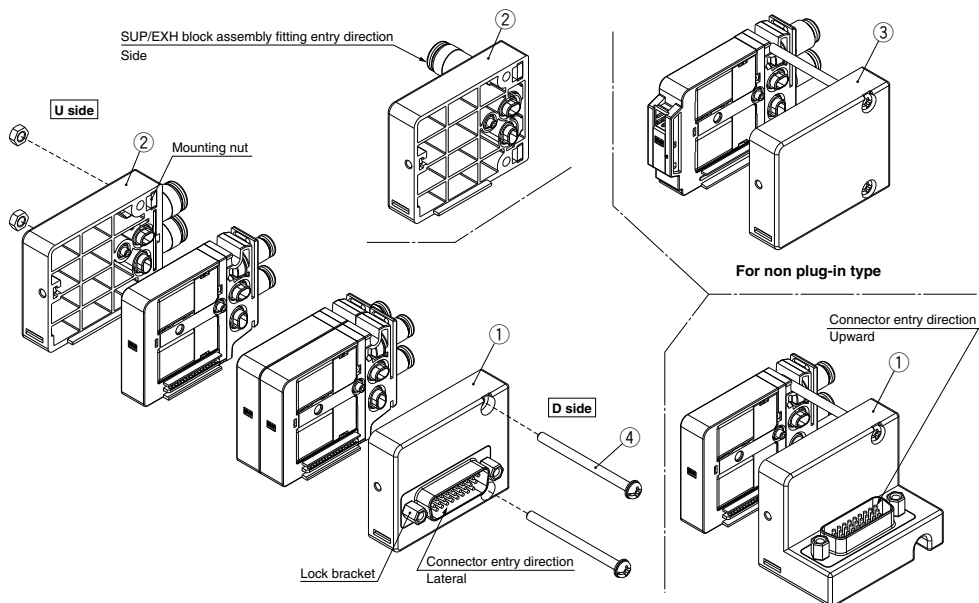

| No. | Description | Part no. | Note |
|-----|--|--|---|
| ① | Connector block assembly ^{Note)} (For plug-in) | V100-192-□A□-15 | Refer to Connector Block Assembly Part No. table below. |
| ② | SUP/EXH end block assembly ^{Note)} (Common for plug-in and non plug-in types) <Fitting entry direction: Standard> | V100-193-1A-□ [Mounting nut (Metric size: M3)] | (Metric size) C4: ø4 One-touch fitting C6: ø6 One-touch fitting L4: ø4 elbow fitting (Upward entry) L6: ø6 elbow fitting (Upward entry) B4: ø4 elbow fitting (Downward entry) B6: ø6 elbow fitting (Downward entry) |
| | | V100-193-2A-□ [Mounting nut (Inch size: No. 10-32 UNF)] | |
| ② | SUP/EXH end block assembly ^{Note)} (Common for plug-in and non plug-in types) <Fitting entry direction: Side> | V100-193-3A-□ [Mounting nut (Metric size: M3)] | (Inch size) N3: ø5/32" One-touch fitting N7: ø1/4" One-touch fitting <Mounting nut part no. (4 pcs./set)> Metric size (M3): V100-197-1A Inch size (No. 10-32 UNF): V100-197-2A |
| | | V100-193-4A-□ [Mounting nut (Inch size: No. 10-32 UNF)] | |
| ③ | End block assembly ^{Note)} (For non plug-in) | V100-199-1A [Mounting nut (Metric size: M3)] | |
| | | V100-199-2A [Mounting nut (Inch size: No. 10-32 UNF)] | |
| ④ | Tension bolt (With hexagon nut) | V100-202-□A | □: Stations (1 to 12) 2 pcs./set |

Note) If a bracket is intended to be mounted, select ① Connector block assembly, ② SUP/EXH end block assembly 1A or 3A, and ③ End block assembly 1A with mounting nut (Metric size: M3).

Connector Block Assembly Part No.

V100-192-□A□-□

Connector entry direction/Mounting nut thread type

| Symbol | Thread type | Connector entry direction |
|--------|---------------------------|---------------------------|
| 1 | Metric size (M3) | Lateral |
| 2 | Inch size (No. 10-32 UNF) | |
| 3 | Metric size (M3) | Upward |
| 4 | Inch size (No. 10-32 UNF) | |

D-sub connector type

| | |
|----|---------|
| 15 | 15 pins |
| 26 | 26 pins |

Lock bracket thread type

| | |
|-----|--------------------------|
| Nil | Metric size (M2.6) |
| U | Inch size (No. 4-40 UNC) |

Manifold Options

■ Bracket Assembly

V100-198-1A (For side ported)
 <Common for upward/
 lateral connectors>

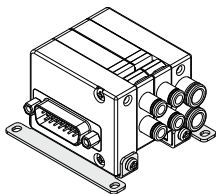

V100-198-3A (For bottom ported)
 <For lateral connector>

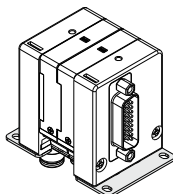

V100-198-4A (For bottom ported)
 <For upward connector>

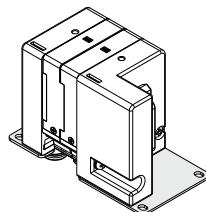

* The screws (M3) with which the bracket is mounted on the manifold are included.

■ Bracket Mounting Procedure

<For side ported>

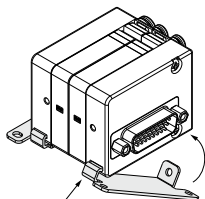

① Fit the bracket to the groove at the connector block (end block).

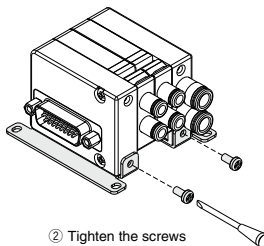

② Tighten the screws
 (Tightening torque M3:
 0.6 N·m).

<For bottom ported>

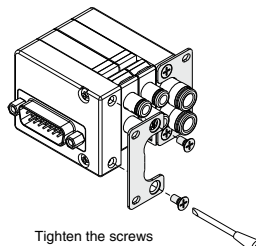

Tighten the screws
 (Tightening torque M3:
 0.6 N·m).

Note) The bracket can be mounted on the block with the mounting nut (Metric size: M3) only. It cannot be mounted on the block with inch-size mounting nut (No. 10-32 UNF).

VV100 Series

Manifold Options

■ Mounting Example

Manifold direct mounting

SUP/EXH block fitting entry direction: Standard

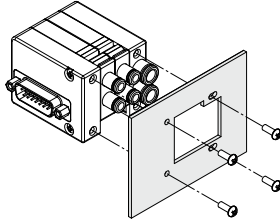

Panel fitting dimensions/Mounting hole dimensions

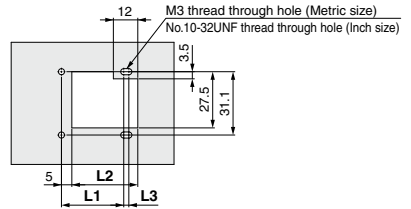

| Station n | 1 | 2 | 3 | 4 | 5 | 6 | 7 | 8 | 9 | 10 | 11 | 12 |
|-----------|------|------|------|------|------|------|------|------|-----|-----|-----|-----|
| L1 | 20.4 | 30.6 | 40.8 | 51 | 61.2 | 71.4 | 81.6 | 91.8 | 102 | 112 | 122 | 133 |
| L2 | 22.4 | 32.8 | 43.2 | 53.6 | 64 | 74.4 | 84.8 | 95.2 | 106 | 116 | 126 | 137 |
| L3 | 1.3 | | | | | | | | 2.5 | | | |

(Reference dimension)

SUP/EXH block fitting entry direction: Side

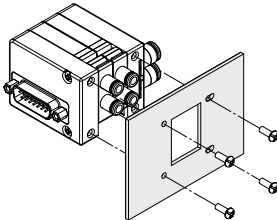

Panel fitting dimensions/Mounting hole dimensions

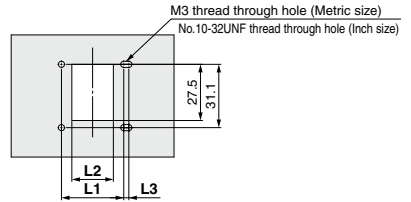

| Station n | 1 | 2 | 3 | 4 | 5 | 6 | 7 | 8 | 9 | 10 | 11 | 12 |
|-----------|------|------|------|------|------|------|------|------|------|-----|-----|-----|
| L1 | 20.4 | 30.6 | 40.8 | 51 | 61.2 | 71.4 | 81.6 | 91.8 | 102 | 112 | 122 | 133 |
| L2 | 10.4 | 20.8 | 31.2 | 41.6 | 52 | 62.4 | 72.8 | 83.2 | 93.6 | 104 | 114 | 125 |
| L3 | 1.3 | | | | | | | | 2.5 | | | |

(Reference dimension)

Bracket mounting (For bottom ported)

Upward connector

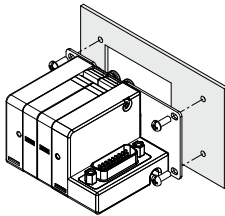

Panel fitting dimensions/Mounting hole dimensions

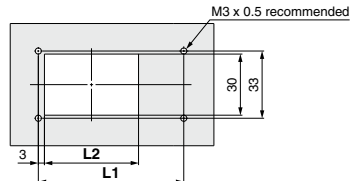

| Station n | 1 | 2 | 3 | 4 | 5 | 6 | 7 | 8 | 9 | 10 | 11 | 12 |
|-----------|------|------|------|------|------|------|------|-----|-----|-----|-----|-----|
| L1 | 61.2 | 71.4 | 81.6 | 91.8 | 102 | 112 | 122 | 133 | 143 | 153 | 163 | 173 |
| L2 | 36.2 | 46.6 | 57 | 67.4 | 77.8 | 88.2 | 98.6 | 109 | 119 | 130 | 140 | 151 |

(Reference dimension)

Lateral connector

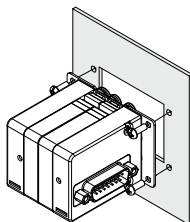

Panel fitting dimensions/Mounting hole dimensions

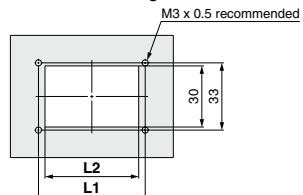

| Station n | 1 | 2 | 3 | 4 | 5 | 6 | 7 | 8 | 9 | 10 | 11 | 12 |
|-----------|------|------|------|------|------|------|------|-----|-----|-----|-----|-----|
| L1 | 52.4 | 62.6 | 72.8 | 83 | 93.2 | 103 | 114 | 124 | 134 | 144 | 154 | 165 |
| L2 | 36.2 | 46.6 | 57 | 67.4 | 77.8 | 88.2 | 98.6 | 109 | 119 | 130 | 140 | 151 |

(Reference dimension)

Manifold Options

D-sub connector cable assembly

For 15 pins V100-DS15-□□□ (N)

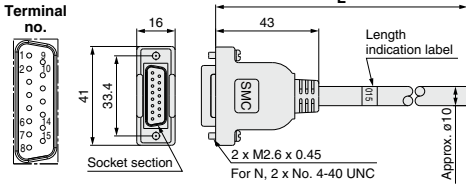

D-sub Connector Cable Assembly

| Cable length L | Assembly part no. | Note |
|----------------|-------------------|--------------------------|
| 1.5 m | V100-DS15-015(N) | Cable 15 cores X23AWG |
| 3 m | V100-DS15-030(N) | |
| 5 m | V100-DS15-050(N) | |

(Note) For N, the unified thread is used.
 For other commercial connectors, use a 15 pin type with female connector conforming to MIL-C24308.

D-sub Connector Cable Assembly Cable Color List of Each Terminal No.

| Terminal no. | Lead wire color | Dot marking |
|--------------|-----------------|-------------|
| 1 | Black | None |
| 2 | Brown | None |
| 3 | Red | None |
| 4 | Orange | None |
| 5 | Yellow | None |
| 6 | Pink | None |
| 7 | Blue | None |
| 8 | Purple | White |
| 9 | Gray | Black |
| 10 | White | Black |
| 11 | White | Red |
| 12 | Yellow | Red |
| 13 | Orange | Red |
| 14 | Yellow | Black |
| 15 | Pink | Black |

Electric Characteristics

| Item | Characteristics |
|--------------------------------------|-----------------|
| Conductor resistance Ω/km, 20°C | 65 or less |
| Withstand pressure V, 1 min, AC | 1000 |
| Insulation resistance MΩ/km, 20°C | 5 or more |

* The minimum bending radius for D-sub connector cables is 20 mm.

For 26 pins V100-DS26-□□□ (N)

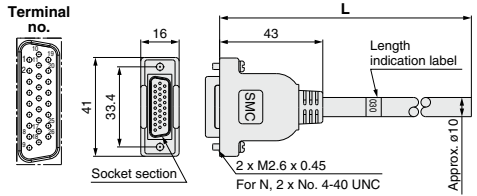

D-sub Connector Cable Assembly

| Cable length L | Assembly part no. | Note |
|----------------|-------------------|--------------------------|
| 1.5 m | V100-DS26-015(N) | Cable 26 cores X23AWG |
| 3 m | V100-DS26-030(N) | |
| 5 m | V100-DS26-050(N) | |

(Note) For N, the unified thread is used.

D-sub Connector Cable Assembly Cable Color List of Each Terminal No.

| Terminal no. | Lead wire color | Dot marking |
|--------------|-----------------|-------------|
| 1 | Black | None |
| 2 | Brown | None |
| 3 | Red | None |
| 4 | Orange | None |
| 5 | Yellow | None |
| 6 | Pink | None |
| 7 | Blue | None |
| 8 | Purple | White |
| 9 | Gray | Black |
| 10 | White | Black |
| 11 | White | Red |
| 12 | Yellow | Red |
| 13 | Orange | Red |
| 14 | Yellow | Black |
| 15 | Pink | Black |
| 16 | Blue | White |
| 17 | Purple | None |
| 18 | Gray | None |
| 19 | Orange | Black |
| 20 | Red | White |
| 21 | Brown | White |
| 22 | Pink | Red |
| 23 | Gray | Red |
| 24 | Black | White |
| 25 | White | None |
| 26 | Light blue | None |



VV100 Series

Specific Product Precautions 1

Be sure to read this before handling the products.

Refer to page 8 for safety instructions and pages 9 to 15 for 3/4/5 port solenoid valve precautions.

Valve with Switch

Warning

When turning off the valve using the switch, move it to the position where the valve is locked. If the switch is at an improper position and is energized, equipment connected to the valve could be actuated.

Also, if the switch is turned OFF on the valve in the energized state, be careful because any actuators connected will actuate.

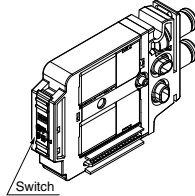

ON position



Normal operation: The valve is switched according to electric signals from the connector on the manifold side.

OFF position

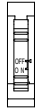

The valve coil is kept in a deenergized state even when there is an electric signal from the connector on the manifold side.

Electric circuit diagram (with positive common and light/surge voltage suppressor)

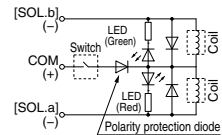

(with negative common and light/surge voltage suppressor)

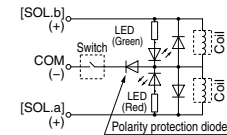

Light/Surge Voltage Suppressor

Caution

Non-Polar Type

Single solenoid

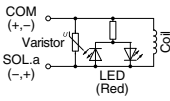

Double solenoid

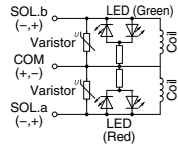

Positive Common

Single solenoid

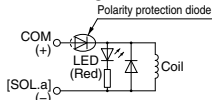

Double solenoid

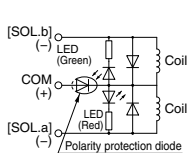

Negative Common

Single solenoid

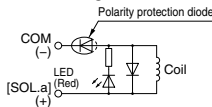

Double solenoid

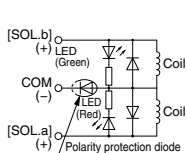

Countermeasure for Surge Voltage Intrusion

Caution

With non-polar type solenoid valves, at times of sudden interruption of the loading power supply, such as emergency shutdown, surge voltage intrusion may be generated from loading equipment with a large capacity (power consumption), and the solenoid valve in a deenergized state may switch over (see Figure 1). When installing a breaker circuit for the loading power supply, consider using a solenoid valve with polarity (with polarity protection diode), or install a surge absorption diode between the loading equipment COM line and the output equipment COM line (see Figure 2).

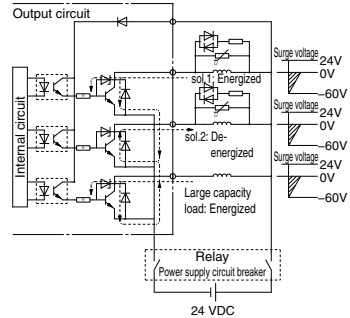

Figure 1. Surge intrusion circuit example (24 VDC)

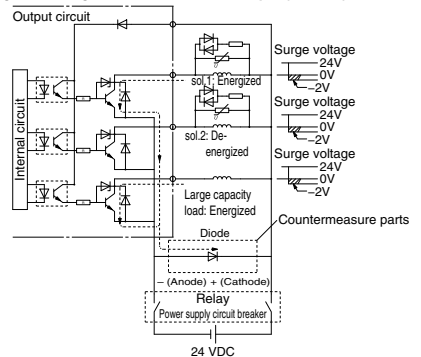

Figure 2. Surge intrusion circuit example (24 VDC)

Continuous Duty

Caution

If a valve is energized continuously for long periods of time, the rise in temperature due to heat-up of the coil may cause a decline in solenoid valve performance, reduce service life, or have adverse effects on peripheral equipment. If a valve will be energized continuously, be sure to use the "Continuous duty type" with a power saving circuit. In particular, there will be a large increase in temperature if 3 or more neighboring stations are simultaneously energized continuously for long periods of time, or if the a and b sides are simultaneously energized continuously for long periods of time. Be very careful in such cases.



VV100 Series Specific Product Precautions 2

Be sure to read this before handling the products.

Refer to page 8 for safety instructions and pages 9 to 15 for 3/4/5 port solenoid valve precautions.

Continuous Duty

⚠ Caution

■ With Power Saving Circuit

Compared to the standard products, power consumption is reduced down to approx. 1/3 (V1□0T) by cutting the unnecessary wattage required to hold the valve in an energized state. (Effective energizing time is over 67 ms at 24 VDC.)

Electric circuit diagram (with power saving circuit)

Positive common, single solenoid

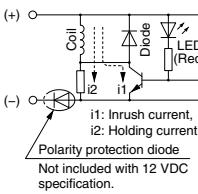

Negative common, single solenoid

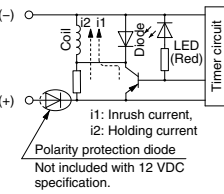

Working Principle

With the circuit above, the current consumption, when holding, is reduced to save energy. Refer to the electric wave data below.

Power waveform of power saving type (V1□0T)

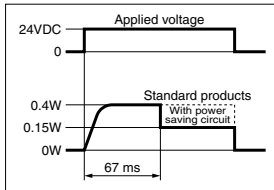

- When a power saving circuit is installed, a diode to prevent reverse current is not available for 12 V DC specification. Therefore, use caution not to connect in reverse.
- Be careful about the allowable voltage fluctuation since a voltage drop of about 0.5 V occurs due to a transistor. (Refer to the solenoid specifications of each valve for details.)

Light Indication

⚠ Caution

When equipped with light/surge voltage suppressor, the light window turns red when solenoid a is energized, and it turns green when solenoid b is energized.

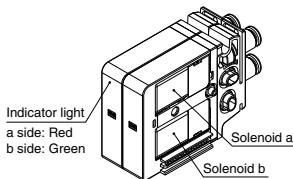

Fitting Replacement

⚠ Caution

By replacing a valve's fitting, it is possible to change the port size of the 2a, 2b, 1(P), and 3(E) ports. When replacing it, pull out the fitting after removing the clip or the plate with a flat head screwdriver, etc. To mount a new fitting, insert it into place and then fully reinsert the clip or the plate.

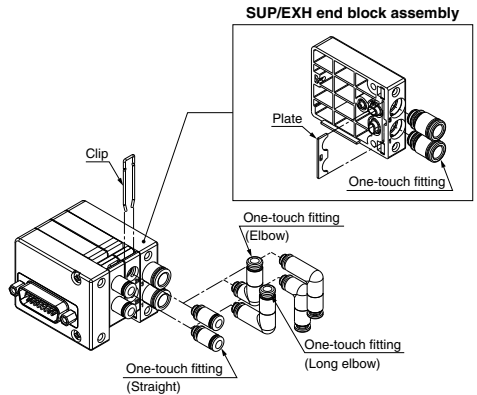

One-touch Fitting Part No.

Metric Size

| Port | Port size | Part no. |
|--------------|-----------------------------------|-----------------|
| 2(a) | ø2 One-touch fitting (Straight) | KJH02-C1 |
| | ø4 One-touch fitting (Straight) | KJH04-C1 |
| | ø2 One-touch fitting (Elbow) | KJL02-C1 |
| | ø4 One-touch fitting (Elbow) | KJL04-C1-N |
| 2(b) | ø2 One-touch fitting (Long elbow) | KJW02-C1 |
| | ø4 One-touch fitting (Long elbow) | KJW04-C1-N |
| 1(P) 3(E) | ø4 One-touch fitting (Straight) | VVQ1000-50A-C4 |
| | ø6 One-touch fitting (Straight) | VVQ1000-50A-C6 |
| | ø4 One-touch fitting (Elbow) | SZ3000-73-1A-L4 |
| | ø6 One-touch fitting (Elbow) | SZ3000-73-1A-L6 |
| | ø4 One-touch fitting (Long elbow) | SZ3000-73-2A-L4 |
| | ø6 One-touch fitting (Long elbow) | SZ3000-73-2A-L6 |

Inch Size

| Port | Port size | Part no. |
|------|-------------------------------------|----------------|
| 2(a) | ø1/8" One-touch fitting (Straight) | KJH01-C1 |
| 2(b) | ø5/32" One-touch fitting (Straight) | KJH03-C1 |
| 1(P) | ø5/32" One-touch fitting (Straight) | VVQ1000-50A-N3 |
| 3(E) | ø1/4" One-touch fitting (Straight) | VVQ1000-50A-N7 |

Note 1) Be careful to avoid damage or contamination to the O-rings, as this can cause air leakage.

Note 2) When removing a straight fitting from a valve, after removing the clip, attach tubing or a plug (KJP-02, KO2P-□□) to the one-touch fitting, and pull it out while holding the tubing or plug. If it is pulled out while holding the release button of the fitting (resin part), the release button may be damaged.

Note 3) Be sure to turn off the power and stop the supply of air before disassembly. Furthermore, since air may remain inside the actuator, piping and manifold, confirm that the air is completely exhausted before starting any work.

Note 4) While inserting a tubing into an elbow fitting, hold the main body of the assembly by hand. Failure to do so will exert an undue force on the valve or the fitting, resulting in air leakage or damage.



VV100 Series

Specific Product Precautions 3

Be sure to read this before handling the products.

Refer to page 8 for safety instructions and pages 9 to 15 for 3/4/5 port solenoid valve precautions.

One-touch Fittings

⚠ Caution

1. Tube attachment/detachment for one-touch fittings

1) Attaching of tubing

(1) Take a tube having no flaws on its periphery and cut it off at a right angle. When cutting the tube, use tube cutters TK-1, 2 or 3. Do not use pinchers, nippers or scissors, etc. If cutting is done with tools other than tube cutters, there is the danger that the tube may be cut diagonally or become flattened, etc., making a secure installation impossible, and causing problems such as the tube pulling out after installation or air leakage. Also allow some extra length in the tube.

(2) Grasp the tube and push it in slowly, inserting it securely all the way into the fitting.

(3) After inserting the tube, pull on it lightly to confirm that it will not come out. If it is not installed securely all the way into the fitting, this can cause problems such as air leakage or the tube pulling out.

2) Detaching of tubing

(1) The 2a and 2b ports use the KJ series, so the tube can be removed by pressing on part of the release button. However, for the 1(P) and 3(E) ports, press the release button evenly as before.

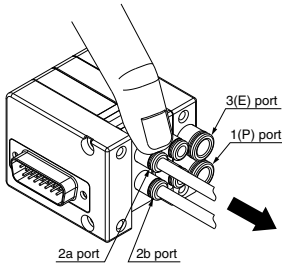

Hold down part of the release button with your finger or a similar tool, as shown in the diagram, and pull out in the direction indicated by the arrow.

(2) Pull out the tube while holding down the release button so that it does not come out. If the release button is not pressed down sufficiently, there will be increased bite on the tube and it will become more difficult to pull it out.

(3) When the removed tube is to be used again, cut off the portion which has been chewed before reusing it. If the chewed portion of the tube is used as is, this can cause trouble such as air leakage or difficulty in removing the tube.

Other Tubing Brands

⚠ Caution

1. When using tube other than SMC brand, confirm the following specifications are satisfied with respect to the outside diameter tolerance of the tube.

- 1) Nylon tubing within ± 0.1 mm
- 2) Soft nylon tubing within ± 0.1 mm
- 3) Polyurethane tubing within $+0.15$ mm, within -0.2 mm

Do not use tubing which does not meet these outside diameter tolerances. It may not be possible to connect them, or they may cause other troubles, such as air leakage or the tube pulling out after connection.

How to Use Plug Connector

⚠ Caution

When attaching and detaching a connector, first shut off the electric power and the air supply. Also, crimp the lead wires and sockets securely.

1. Attaching and detaching connectors

- To attach a connector, hold the lever and connector unit between your fingers and insert straight onto the pins of the solenoid valve so that the lever's pawl is pushed into the groove and locks.
- To detach a connector, remove the pawl from the groove by pushing the lever downward with your thumb, and pull the connector straight out.

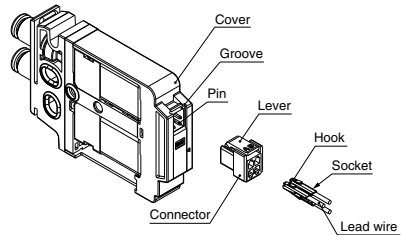

2. Crimping of lead wires and sockets

Peel 3.2 to 3.7 mm of the tip of lead wire, enter the core wires neatly into a socket and crimp it with a special crimp tool. Be careful so that the cover of lead wire does not enter into the crimping part. (Crimping tool: Model no. DXT170-75-1)

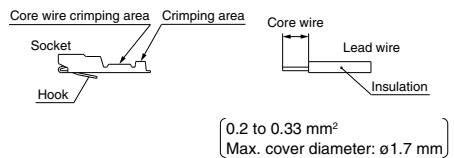



VV100 Series

Specific Product Precautions 4

Be sure to read this before handling the products.

Refer to page 8 for safety instructions and pages 9 to 15 for 3/4/5 port solenoid valve precautions.

How to Use Plug Connector

⚠ Caution

3. Attaching and detaching lead wires with sockets

• Attaching

Insert the sockets into the square holes of the connector (with A, B, C, and N indication), and continue to push the sockets all the way in until the lock by hooking into the seats in the connector. (When they are pushed in, their hooks open and they are locked automatically.) Next, confirm that they are locked by pulling lightly on the lead wires.

• Detaching

To detach a socket from a connector, pull out the lead wire while pressing the socket's hook with a stick having a thin tip (approx. 1 mm). If the socket is used again, spread the hook outward.

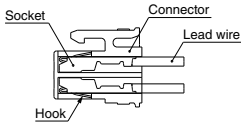

<Positive common>

Single solenoid

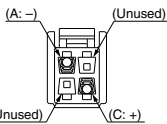

Double solenoid

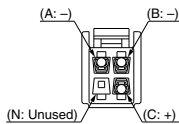

<Negative common>

Single solenoid

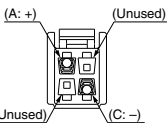

Double solenoid

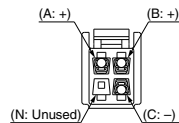

Plug Connector Lead Wire Length

⚠ Caution

Plug connector lead wires have a standard length of 300 mm, however, the following lengths are also available.

■ Connector Assembly Part No.

For single solenoid

SJ3000-46-S-□ (for positive common)

SJ3000-47-S-□ (for negative common)

For double solenoid

SJ3000-46-D-□ (for positive common)

SJ3000-47-D-□ (for negative common)

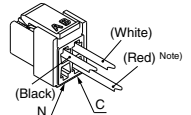
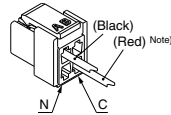
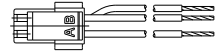
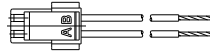

Note) In case of negative common, the lead wire changes from red to yellow.

| Lead wire length | |
|------------------|---------|
| Nil | 300 mm |
| 6 | 600 mm |
| 10 | 1000 mm |
| 15 | 1500 mm |
| 20 | 2000 mm |
| 25 | 2500 mm |
| 30 | 3000 mm |
| 50 | 5000 mm |

For single solenoid: SJ3000-46-S-□
 For double solenoid: SJ3000-46-D-□

Common specifications

46 For positive common

47 For negative common

For single solenoid

Without lead wire: SJ3000-46-S-N
(positive/negative common)

(Connector, Socket x 2 pcs. only)

For double solenoid

Without lead wire: SJ3000-46-D-N
(positive/negative common)

(Connector, Socket x 3 pcs. only)

■ How to Order

Include the connector assembly part number together with the part number for the plug connector's solenoid valve without connector.

(Example) In case of lead wire length 2000 mm and positive common
V110N-D5MOZ-C4
SJ3000-46-D-20



VV100 Series Specific Product Precautions 5

Be sure to read this before handling the products.

Refer to page 8 for safety instructions and pages 9 to 15 for 3/4/5 port solenoid valve precautions.

Connector Assembly for Manifolds (for Junction Common)

⚠ Caution

Using the connector assembly (for junction common) for solenoid valves installed in the manifold reduces the labor involved in wiring work because common wiring for all solenoid valves is integrated into a single wire.

■ Connector Assembly Part No. (for Junction Common)

For single solenoid

SJ3000-46-SC-□ (for positive common)

SJ3000-47-SC-□ (for negative common)

For double solenoid

SJ3000-46-DC-□ (for positive common)

SJ3000-47-DC-□ (for negative common)

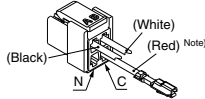
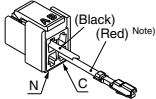
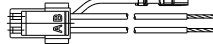
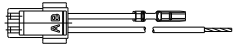

Note) In case of negative common, the lead wire changes from red to yellow.

| For single solenoid: SJ3000-46-SC-□ | | Lead wire length | |
|-------------------------------------|---------|------------------|---------|
| Nil | 300 mm | 6 | 600 mm |
| 10 | 1000 mm | 15 | 1500 mm |
| 20 | 2000 mm | 25 | 2500 mm |
| 30 | 3000 mm | 50 | 5000 mm |

| Common specifications | |
|-----------------------|---------------------|
| 46 | For positive common |
| 47 | For negative common |

For junction common

■ How to Order

Indicate the part no. of the connector assembly for the manifold and solenoid valve.

If the arrangement is complicated, specify them by means of the manifold specification sheet.

Note 1) Applications like connectors not wired to a valve is not possible.

Note 2) For the solenoid valve, designate "Without connector (MOZ)" for the connector type.

Note 3) Connector assembly with lead wire for place where the signals are transmitted to the common wiring. (Only the valves of first station and/or last station of manifold are compatible to connector with lead wire for common.)

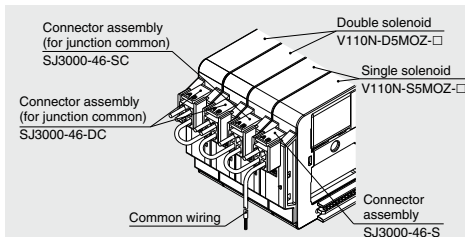

(Example)

- VV100-10-04U1-C6 1 set
- * V110N-S5MOZ-C4 2 sets
- * V110N-D5MOZ-C4 2 sets
- * SJ3000-46-S 1 set (Connector assembly for single solenoid)
- * SJ3000-46-SC 1 set (Connector assembly for single solenoid (for junction common))
- * SJ3000-46-DC 2 sets (Connector assembly for double solenoid (for junction common))

The asterisk denotes the symbol for assembly. Prefix it to the part nos. of the solenoid valve, etc.

Wiring Procedure for Connector Assembly (for Junction Common)

⚠ Caution

If only connector assembly (for junction common) is ordered, please wire according to the instructions in the diagram below. For details on socket mounting, refer to "How to Use Plug Connector" on the page 1163.

