

5 Port Solenoid Valve

SV1000/2000/3000/4000 Series

Rubber Seal

The connection cable and various units for PLC connection in PC wiring systems have been discontinued by the manufacturer. Therefore, while they can no longer be provided, the valve manifold (manifold with built-in valves) can still be ordered. For details, refer to the **Web Catalog**.

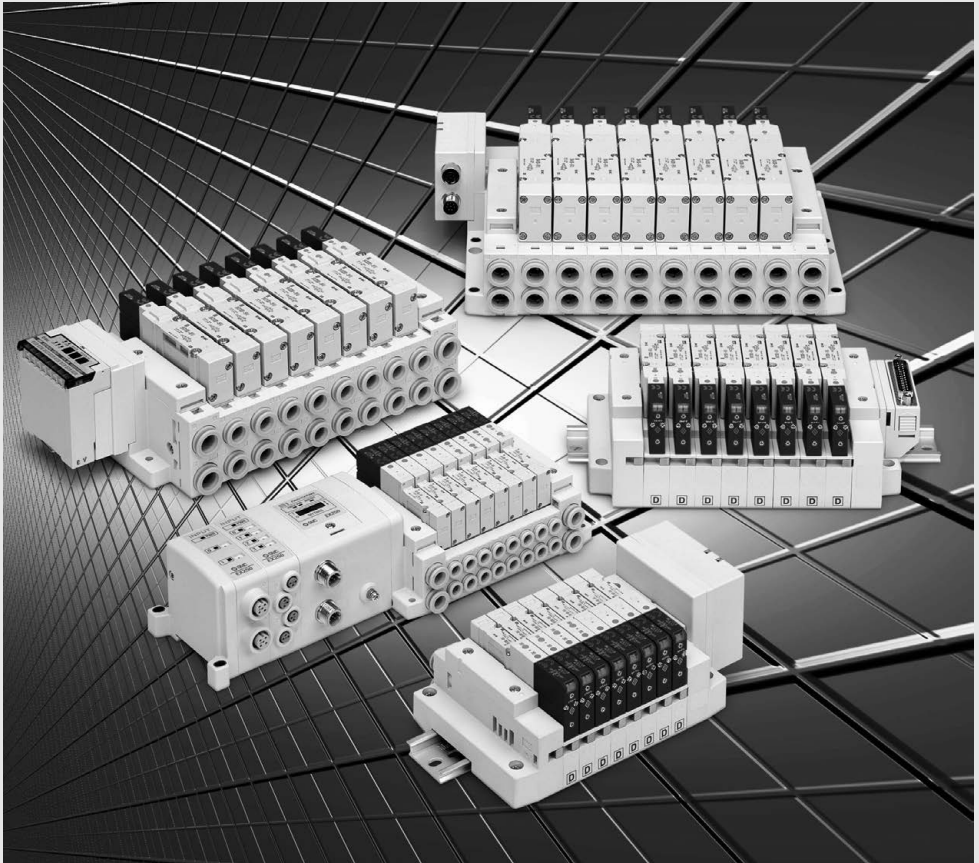

Connector Type Manifold

Connector Type Manifold SV1000/2000/3000/4000 Series

- The use of multi-pin connectors to replace wiring inside manifold blocks provides flexibility when adding stations or changing manifold configuration.

The SV Series employs a multi-connector instead of the current lead wires for internal. By connecting each block with a connector, changes to manifold stations are greatly simplified.

Connector wiring diagram

For both serial and parallel wiring, additional manifold blocks are sequentially assigned pins on the connector. This makes it completely unnecessary to disassemble the connector unit.

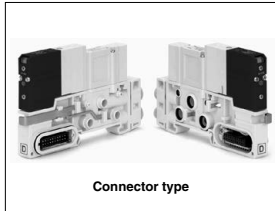
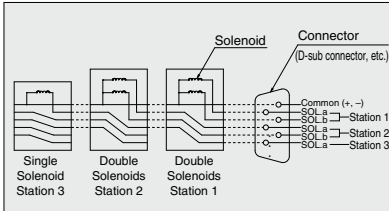

Service life of 50 million cycles or more
(Based on SMC life test conditions)

■ Cassette base type manifold (For SV1000/2000)

Cassette base type manifolds offer the ultimate in flexibility. Manifold sections can be added using a simple release mechanism.

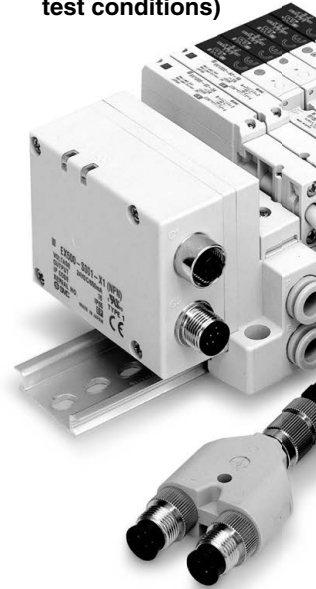
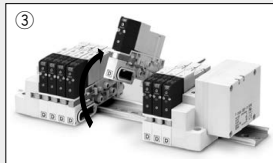
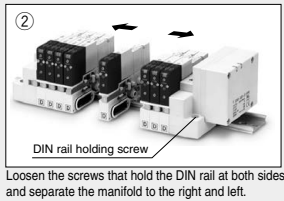
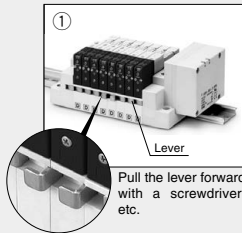

Power consumption: 0.6 W
(Current: 25 mA, 24 VDC)

■ Tie-rod base manifold (For SV1000/2000/3000/4000)

Current tie-rod base type manifolds are also available. 34 pins connector allows up to 16 stations with double solenoids. (Refer to the tie-rod base manifold exploded view on page 114.)

- A relay output module control of devices up to 110 VAC, 3 A.

■ The standard product is CE/UKCA-compliant and UL-standard.

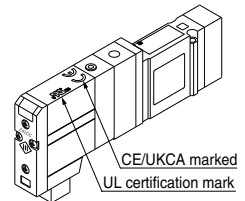

■ EX500 Series: Gateway-type, serial transmission system

- IP67 compliant (Gateway unit and input manifold are compliant with IP65.)
- No. of input/output point: 128 points (Output 64 points, Input 64 points)
- Controls up to 4 branches with 32 I/O per branch
- A single cable from the gateway provides both signal and power for each branch, eliminating the need for separate power connections for each manifold.

■ EX250 Series: Integrated-type (for I/O), serial transmission system

- IP67 compliant (compliant with IP40.)
- No. of input/output point: 64 points (Output 32 points, Input 32 points)
- Double solenoid allows up to 16 stations (up to 32 solenoids).

■ Interface regulator SV1000, 2000, 3000, 4000 series

- P port regulation, A port regulation and B port regulation are selectable, depending on an application. Able to set the pressure arbitrarily for each station of the manifold just by inserting between manifold base and valve.



■ Increased moisture and dust resistance.

- Enclosure against foreign matters and water is conforming to IP67*. Can be used in an atmosphere where the valve or manifold is exposed by water, etc. directly. (* Based on IEC60529) (Refer to the catalog contents for details, as some types of connectors do not meet these standards.)

■ 4 position dual 3 port valves available for the SV1000/2000 series

- Two 3 port valves built into a single valve body.
- A and B ports can be individually controlled.
- Three combinations are available: [N.C./N.C.], [N.O./N.O.], and [N.C./N.O.].
- Mixed mounting with 5 port valves is also possible.
- Labels are attached to indicate A and B side functions, using the same color as the manual override.

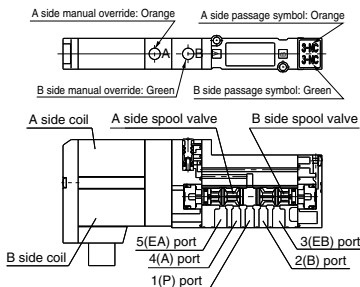

| Model | A side | B side | Symbol | |
|--------|------------|------------|---------------|---------------|
| | | | SV1000 series | SV2000 series |
| SV1A00 | N.C. valve | N.C. valve | | |
| | | | | |
| SV1B00 | N.O. valve | N.O. valve | | |
| | | | | |
| SV1C00 | N.C. valve | N.O. valve | | |

* External pilot specifications is not available for 4 position dual 3 port valves.

INDEX

SV Series Manifold Variations

Serial Wiring

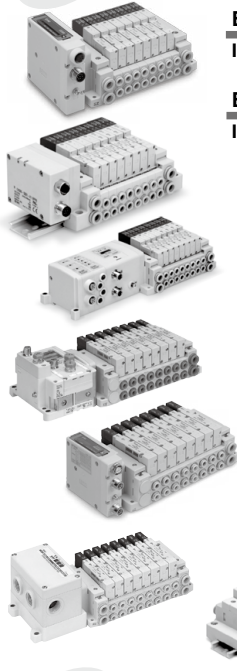

Valve Manifold Common Specifications P. 24

EX500 Gateway Decentralized System 2 P. 28

IP67 compliant Applicable series **Tie-rod base manifold**
SV1000/SV2000/SV3000
 • Number of output points: 32 points • Connected to the SI unit of the EX500

EX500 Gateway Decentralized System P. 33

IP67 compliant Applicable series **Cassette base manifold**
SV1000/SV2000
Tie-rod base manifold
SV1000/SV2000/SV3000/SV4000
 • Number of output points: 16 points • Connected to the SI unit of the EX500

EX250 Integrated-type (For I/O) Serial Transmission System P. 41

IP67 (partly IP40) compliant Applicable series **Tie-rod base manifold**
SV1000/SV2000/SV3000
 • Number of input/output points: Each 32 points

EX600 Integrated-type (For I/O) Serial Transmission System P. 47

IP67 compliant Applicable series **Tie-rod base manifold**
SV1000/SV2000/SV3000
 • Digital input/output: Max. 144 inputs/144 outputs
 • Analog input: Max. 18 channels
 • Valve output: 32 outputs

EX260 Integrated-type (For Output) Serial Transmission System P. 57

IP67 (partly IP40) compliant Applicable series **Tie-rod base manifold**
SV1000/SV2000/SV3000
 • Number of output points: 16 points

EX126 Integrated-type (For Output) Serial Transmission System P. 63

IP67 compliant Applicable series **Tie-rod base manifold**
SV1000/SV2000/SV3000
 • Number of output points: 16, 32 points

EX120 Integrated-type (For Output) Serial Transmission System P. 69

Applicable series **Cassette base manifold**
SV1000/SV2000
Tie-rod base manifold
SV1000/SV2000/SV3000/SV4000
 • Number of output points: 16 points

Parallel Wiring

For Circular Connector

IP67 compliant Applicable series **Cassette base manifold**
SV1000/SV2000
Tie-rod base manifold
SV1000/SV2000/SV3000/SV4000
 • Number of connectors: 26 pins

D-sub Connector P. 89

Applicable series **Cassette base manifold**
SV1000/SV2000
Tie-rod base manifold
SV1000/SV2000/SV3000/SV4000
 • Number of connectors: 25 pins
 • MIL-C-24308 Conforming to JIS-X-5101

Flat Ribbon Cable Connector P. 99

Applicable series **Cassette base manifold**
SV1000/SV2000
Tie-rod base manifold
SV1000/SV2000/SV3000/SV4000
 • Number of connectors: 26, 20, 10 pins
 • With strain relief Conforming to MIL-C-83503

Single Valve/Sub-plate [IP67 compliant] P. 126

IP67 compliant Applicable series **SV1000/SV2000/SV3000/SV4000**
 • With waterproof M12 connector

Made to Order Specifications P. 134



Valve Manifold Common Specifications

SV Series



Cassette base manifold

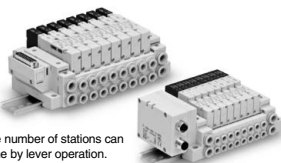

• Changing the number of stations can be easily done by lever operation.

Manifold Specifications

| Applicable series | | SV1000 | SV2000 |
|--------------------------------------|--------------------------|--------------------------------------|--------------------------|
| Manifold type | | Stacking type cassette base manifold | |
| 1 (P: SUP), 3/5 (E: EXH) type | | Common SUP, EXH | |
| Valve stations (maximum) | | 18 stations | 20 stations |
| Max. number of solenoids | | 18 points | 26 points |
| Port size | 1(P), 3/5(E) port | C8, N9 | C10, N11 |
| | 4(A), 2(B) port | C3, C4, C6 N1, N3, N7 | C4, C6, C8 N3, N7, N9 |

Flow Rate Characteristics

| Model | Port size | | Flow rate characteristics | | | | | |
|----------|------------------------|----------------|------------------------------|------|------|------------------------------|------|------|
| | 1, 5, 3 (P, EA, EB) | 4, 2 (A, B) | 1→4/2 (P→A/B) | | | 4/2→3/5 (A/B→E) | | |
| | | | C [dm ³ /(s·bar)] | b | Cv | C [dm ³ /(s·bar)] | b | Cv |
| SS5V1-16 | C8 | C6 | 0.89 | 0.22 | 0.22 | 0.98 | 0.21 | 0.23 |
| SS5V2-16 | C10 | C8 | 2.3 | 0.28 | 0.50 | 2.7 | 0.18 | 0.56 |

Note) The value is for manifold base with 5 stations and individually operated 2 position type.

Tie-rod base manifold



• 34 pins connector allows up to 16 stations with double solenoids.

Manifold Specifications

| Applicable series | | SV1000 | SV2000 | SV3000 | SV4000 |
|--------------------------------------|--------------------------|--------------------------|--------------------------|----------------------------|---------------------------------|
| Manifold type | | Tie-rod base manifold | | | |
| 1 (P: SUP), 3/5 (E: EXH) type | | Common SUP, EXH | | | |
| Valve stations (maximum) | | 20 stations | | | |
| Max. number of solenoids | | 32 points | | | |
| Port size | 1(P), 3/5(E) port | C8, N9 | C10, N11 | C12, N11 | C12, N11, 03 |
| | 4(A), 2(B) port | C3, C4, C6 N1, N3, N7 | C4, C6, C8 N3, N7, N9 | C6, C8, C10 N7, N9, N11 | C8, C10, C12 N9, N11, 02, 03 |

Flow Rate Characteristics

| Model | Port size | | Flow rate characteristics | | | | | |
|----------|------------------------|----------------|------------------------------|------|------|------------------------------|------|------|
| | 1, 5, 3 (P, EA, EB) | 4, 2 (A, B) | 1→4/2 (P→A/B) | | | 4/2→3/5 (A/B→E) | | |
| | | | C [dm ³ /(s·bar)] | b | Cv | C [dm ³ /(s·bar)] | b | Cv |
| SS5V1-10 | C8 | C6 | 0.98 | 0.26 | 0.24 | 1.1 | 0.35 | 0.28 |
| SS5V2-10 | C10 | C8 | 2.1 | 0.20 | 0.46 | 2.4 | 0.18 | 0.48 |
| SS5V3-10 | C12 | C10 | 4.2 | 0.22 | 0.91 | 4.3 | 0.21 | 0.93 |
| SS5V4-10 | C12 | C12 | 6.2 | 0.19 | 1.3 | 7.0 | 0.18 | 1.6 |

Note) The value is for manifold base with 5 stations and individually operated 2 position type.

Enclosure of Manifold Variations (Common for cassette base and tie-rod base)

| Series | Enclosure (Based on IEC60529) |
|--|-------------------------------|
| EX500 (Gateway Decentralized System 2 (128 points)) Serial Transmission System | IP67 Note 1) |
| EX500 (Gateway Decentralized System (64 points)) Serial Transmission System | IP67 Note 2) |
| EX250 Serial Transmission System | IP67 (partly IP40) |
| EX600 Serial Transmission System | IP67 |
| EX260 Serial Transmission System | IP67 (partly IP40) |
| EX126 Serial Transmission System | IP67 |
| EX120 Serial Transmission System | IP20 |
| Circular connector | IP67 |
| D-sub connector | Dusttight (IP40) |
| Flat ribbon cable | Dusttight (IP40) |

Note 1) Enclosure of a gateway unit is IP65.

Note 2) Enclosure of a gateway unit and input manifold is IP65.

SV Series Solenoid Valve Specifications

Made to Order Specifications
(For details, refer to page 134.)

Symbol

SV1000/2000/3000/4000

2 position single solenoid

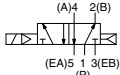

2 position double solenoid

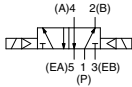

SV1000/2000/3000

3 position closed center

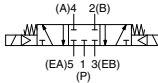

SV4000

3 position exhaust center

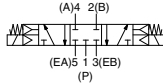

3 position exhaust center

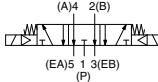

3 position pressure center



3 position pressure center

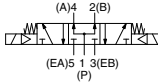

3 position pressure center

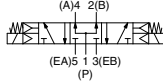

SV1000

4 position dual 3 port valve

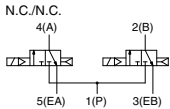

N.C./N.C.

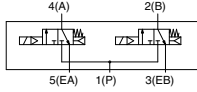

N.O./N.O.

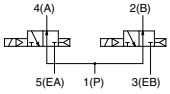

N.O./N.O.

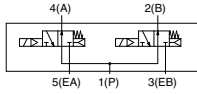

N.C./N.O.

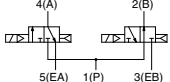

N.C./N.O.

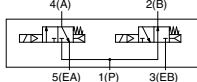

* SV3000 and 4000 are not available with 4 position dual 3 port valve.

| | | |
|--|---|---|
| Fluid | | Air |
| Internal pilot Operating pressure range (MPa) | 2 position single 4 position dual 3 port valve | 0.15 to 0.7 |
| External pilot Operating pressure range (MPa) | 2 position double | 0.1 to 0.7 |
| | 3 position | 0.2 to 0.7 |
| Ambient and fluid temperature (°C) | Operating pressure range | -100 kPa to 0.7 |
| | 2 position single, double 3 position | 0.25 to 0.7 |
| Max. operating frequency (Hz) | 2 position single, double 4 position dual 3 port valve | 5 |
| Manual override | 3 position | 3 |
| | | Non-locking push type Push-turn locking slotted type |
| Pilot exhaust method | Internal pilot | Common exhaust type for main and pilot valve |
| | External pilot | Pilot valve individual exhaust |
| Lubrication | | Not required |
| Mounting orientation | | Unrestricted |
| Impact/Vibration resistance (ms²) | | 150/30 |
| Enclosure | | IP67 (Based on IEC60529) |
| Coil rated voltage | | 24 VDC, 12 VDC |
| Allowable voltage fluctuation | | ±10% of rated voltage |
| Power consumption | | 0.6 (With indicator light: 0.65) |
| Surge voltage suppressor | | Zener diode |
| Indicator light | | LED |

Note) Impact resistance: No malfunction occurred when it is tested with a drop tester in the axial direction and at the right angles to the main valve and armature in both energized and de-energized states every once for each condition. (Values at the initial period)

Vibration resistance: No malfunction occurred in a one-sweep test between 45 and 2000 Hz. Test was performed at both energized and de-energized states in the axial direction and at the right angles to the main valve and armature. (Values at the initial period)

Response Time

| Type of actuation | Response time (ms) (at the pressure of 0.5 MPa) | | | |
|------------------------------|---|------------|------------|------------|
| | SV1000 | SV2000 | SV3000 | SV4000 |
| 2 position single | 11 or less | 25 or less | 28 or less | 40 or less |
| 2 position double | 10 or less | 17 or less | 26 or less | 40 or less |
| 3 position | 18 or less | 29 or less | 32 or less | 82 or less |
| 4 position dual 3 port valve | 15 or less | 33 or less | — | — |

Note) Based on dynamic performance test, JIS B 8419: 2010.
(Coil temperature: 20°C, at rated voltage)

Weight

| Series | Type of actuation | Weight (g) |
|--------|------------------------|------------|
| SV1000 | Single solenoid | 66 |
| | Double solenoid | 71 |
| | 3 position | 73 |
| | 4 position dual 3 port | 71 |
| SV2000 | Single solenoid | 74 |
| | Double solenoid | 78 |
| | 3 position | 83 |
| | 4 position dual 3 port | 78 |
| SV3000 | Single solenoid | 99 |
| | Double solenoid | 102 |
| | 3 position | 110 |
| SV4000 | Single solenoid | 186 |
| | Double solenoid | 190 |
| | 3 position | 211 |

Note) Weight of solenoid valve only.

Gateway-type Serial Transmission System

EX500 Series

IP67 compliant

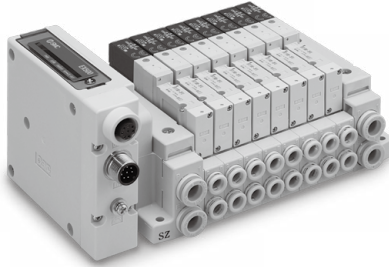

EX500 Gateway Decentralized System 2 **P.28**

| | |
|-------------------|--|
| Applicable series | Tie-rod base manifold SV1000/SV2000/SV3000 |
| | <ul style="list-style-type: none">• Number of output points: 32 points• Connected to the SI unit of the EX500 |

IP67 compliant

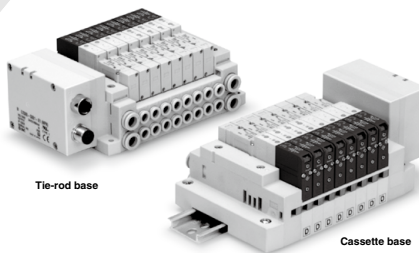

EX500 Gateway Decentralized System **P.33**

| | |
|--|--|
| Applicable series | Cassette base manifold SV1000/SV2000 |
| | Tie-rod base manifold SV1000/SV2000/SV3000/SV4000 |
| <ul style="list-style-type: none">• Number of output points: 16 points• Connected to the SI unit of the EX500 | |

EX500 (Gateway Decentralized System 2 (128 Points)) Serial Transmission System



SV Series

How to Order Manifold

● Tie-rod base

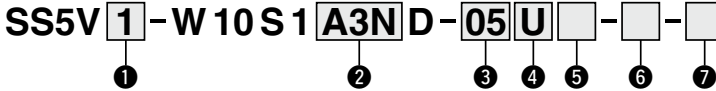

① Series

| | |
|---|--------|
| 1 | SV1000 |
| 2 | SV2000 |
| 3 | SV3000 |

② SI unit (Number of outputs, Output polarity, Max. number of valve stations, Protocol)

| | |
|-----|--|
| 0 | Without SI unit |
| A3N | 32 outputs ^{Note 1) 3)} , 2 to 16 stations ^(20 stations ^{Note 2)}) |

Note 1) 16 outputs can be set by switching the built-in setting switch.

Note 2) (): Maximum number of stations for mixed single and double wiring.

Note 3) When using the SI unit with 32 outputs, use the GW unit compatible with the EX500 Gateway Decentralized System 2 (128 points).

③ Valve stations

| Symbol | Stations | Note |
|--------|-------------|---|
| 02 | 2 stations | Double wiring ^{Note 1)} |
| ⋮ | ⋮ | |
| 16 | 16 stations | |
| 02 | 2 stations | Specified layout ^{Note 2)} (Available up to 32 solenoids) |
| ⋮ | ⋮ | |
| 20 | 20 stations | |

Note 1) Double wiring: single, double, 3-position and 4-position valves can be used on all manifold stations.

Use of a single solenoid will result in an unused control signal. If this is not desired, order with a specified layout.

Note 2) Specified layout: Indicate the wiring specifications on the manifold specification sheet. (Note that double, 3-position and 4-position valves cannot be used where single wiring has been specified.)

SI unit part no. EX500-S103

④ P, E port entry

| | |
|---|-------------------------------|
| U | U side (2 to 10 stations) |
| D | D side (2 to 10 stations) |
| B | Both sides (2 to 20 stations) |

⑤ SUP/EXH block assembly

| | |
|-----|--|
| Nil | Internal pilot |
| S | Internal pilot, Built-in silencer ^{Note)} |
| R | External pilot |
| RS | External pilot, Built-in silencer ^{Note)} |

Note) When the built-in silencer type is used, keep the exhaust port from coming in direct contact with water or other liquids.

⑦ Mounting

| | |
|----------------------|---|
| Nil | Direct mounting |
| D | With DIN bracket, DIN rail with standard length |
| D0 | With DIN bracket, without DIN rail |
| D3 ^{Note)} | With DIN bracket, DIN rail for 3 stations |
| ⋮ | ⋮ |
| D20 ^{Note)} | With DIN bracket, DIN rail for 20 stations |

Note) Specify a longer rail than the length of valve stations.

* If the DIN rail must be mounted without an SI unit, select "D0" and order the DIN rail separately. Refer to L3 of the dimensions for the DIN rail length. For the DIN rail part number, refer to page 123.

⑥ A, B port size

Metric size

| Symbol | A, B port | P, E port | Applicable series |
|--------------------|------------------------|--------------------------|-------------------|
| C3 | ø3.2 One-touch fitting | ø8 One-touch fitting | SV1000 |
| C4 | ø4 One-touch fitting | | |
| C6 | ø6 One-touch fitting | | |
| C4 | ø4 One-touch fitting | ø10 One-touch fitting | SV2000 |
| C6 | ø6 One-touch fitting | | |
| C8 | ø8 One-touch fitting | | |
| C6 | ø6 One-touch fitting | ø12 One-touch fitting | SV3000 |
| C8 | ø8 One-touch fitting | | |
| C10 | ø10 One-touch fitting | | |
| M ^{Note)} | A, B port mixed | | |

Inch size

| Symbol | A, B port | P, E port | Applicable series |
|--------------------|--------------------------|-----------------------------|-------------------|
| N1 | ø1/8" One-touch fitting | ø5/16" One-touch fitting | SV1000 |
| N3 | ø5/32" One-touch fitting | | |
| N7 | ø1/4" One-touch fitting | | |
| N3 | ø5/32" One-touch fitting | ø3/8" One-touch fitting | SV2000 |
| N7 | ø1/4" One-touch fitting | | |
| N9 | ø5/16" One-touch fitting | | |
| N7 | ø1/4" One-touch fitting | ø3/8" One-touch fitting | SV3000 |
| N9 | ø5/16" One-touch fitting | | |
| N11 | ø3/8" One-touch fitting | | |
| M ^{Note)} | A, B port mixed | | |

Note) Indicate the sizes on the manifold specification sheet.

* The X and PE port size of external pilot type [R, RS] are ø4 (mm) or ø5/32" (inch) for the SV1000/2000 series, and ø6 (mm) or ø1/4" (inch) for the SV3000 series.

* A separate GW unit and communication cable are required.

For details about the EX500 series, refer to the [Web Catalog](#).

How to Order Manifold Assembly

Example

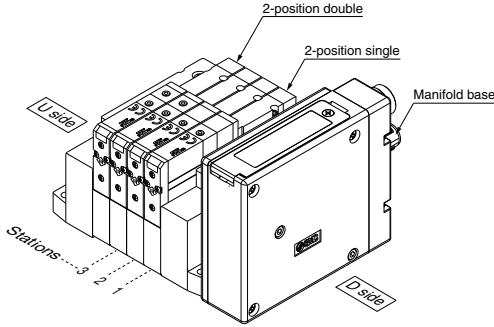

SS5V1-W10S1A3ND-04B-C6.....1 set (Manifold base part number)
 * SV1100-5FU.....2 sets (2-position single part number)
 * SV1200-5FU.....2 sets (2-position double part number)

The asterisk denotes the symbol for assembly.
 Prefix it to the part numbers of the valve etc.

- The valve arrangement is numbered as the 1st station from the D side.
- Under the manifold base part number, state the valves to be mounted in order from the 1st station as shown in the figure above. If the arrangement becomes complicated, specify on the manifold specification sheet.

How to Order Valves

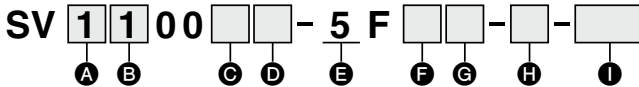

A Series

| | |
|---|--------|
| 1 | SV1000 |
| 2 | SV2000 |
| 3 | SV3000 |

B Type of actuation

| | |
|---|----------------------------|
| 1 | 2-position single |
| 2 | 2-position double |
| 3 | 3-position closed center |
| 4 | 3-position exhaust center |
| 5 | 3-position pressure center |

A Note) 4-position dual 3-port valve (N.C./N.O.)

B Note) 4-position dual 3-port valve (N.O./N.O.)

C Note) 4-position dual 3-port valve (N.C./N.O.)

Note) Select the SV1000 or SV2000 series for the 4-position dual 3-port valve.

* Select the internal pilot type for the 4-position dual 3-port valve.

C Pilot type

| | |
|-----|----------------|
| Nil | Internal pilot |
| R | External pilot |

D Back pressure check valve

| | |
|-----|----------|
| Nil | None |
| K | Built-in |

* Built-in back pressure check valve type is applicable to the SV1000 series only.

* The product with a back pressure check valve is not available for 3-position valves.

Note) Refer to Specific Product Precautions 2 on page 136.

E Rated voltage

| | |
|---|--------|
| 5 | 24 VDC |
|---|--------|

F Light/surge voltage suppressor

| | |
|---|--|
| U | With light/surge voltage suppressor |
| R | Without light, with surge voltage suppressor |

G Manual override

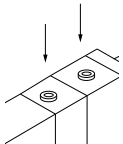
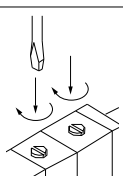
| |
|---|
| <p>Nil</p> <p>Non-locking push</p>  |
| <p>D</p> <p>Push-turn locking (slotted)</p>  |

H Manifold block

If stations are to be added, order the product with manifold block.
 (For details, refer to page 119.)

I Made to Order

| | |
|-----|---|
| Nil | — |
| X90 | Main valve fluororubber specification (For details, refer to page 134.) |

Dimensions: SV1000 Series for EX500 Gateway Decentralized System 2 (128 points)

● Tie-rod base manifold

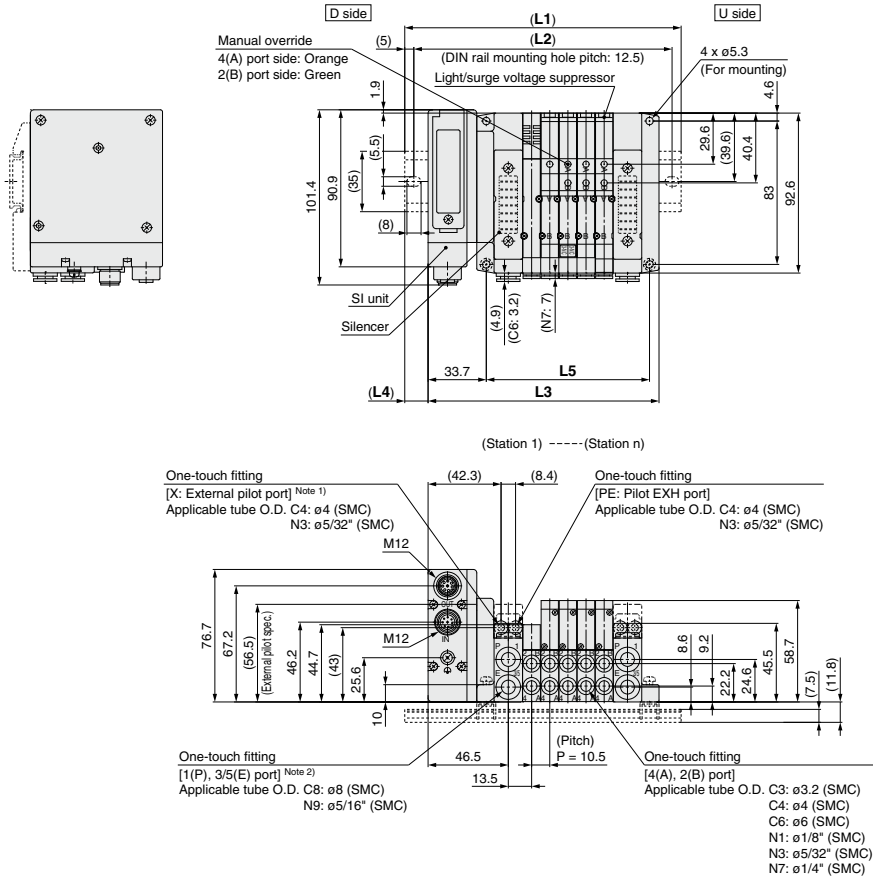

Note 1) External pilot port positions and silencer discharge port positions are the same as P, E port outlet positions.
Note 2) When P, E port outlets are indicated on the U side or D side, the P, E ports on the opposite side are plugged.

L: DIN Rail Overall Length

n: Stations

| L \ n | 2 | 3 | 4 | 5 | 6 | 7 | 8 | 9 | 10 | 11 | 12 | 13 | 14 | 15 | 16 | 17 | 18 | 19 | 20 |
|-----------|-------|-------|-------|-------|-------|-------|-------|-------|-------|-------|-------|-------|-------|-------|-------|-------|-------|-------|-------|
| L1 | 135.5 | 148 | 148 | 160.5 | 173 | 185.5 | 198 | 210.5 | 210.5 | 223 | 235.5 | 248 | 260.5 | 273 | 273 | 285.5 | 298 | 310.5 | 323 |
| L2 | 125 | 137.5 | 137.5 | 150 | 162.5 | 175 | 187.5 | 200 | 200 | 212.5 | 225 | 237.5 | 250 | 262.5 | 262.5 | 275 | 287.5 | 300 | 312.5 |
| L3 | 102.2 | 112.7 | 123.2 | 133.7 | 144.2 | 154.7 | 165.2 | 175.7 | 186.2 | 196.7 | 207.2 | 217.7 | 228.2 | 238.7 | 249.2 | 259.7 | 270.2 | 280.7 | 291.2 |
| L4 | 16.5 | 17.5 | 12.5 | 13.5 | 14.5 | 15.5 | 16.5 | 17.5 | 12 | 13 | 14 | 15 | 16 | 17 | 12 | 13 | 14 | 15 | 16 |
| L5 | 63 | 73.5 | 84 | 94.5 | 105 | 115.5 | 126 | 136.5 | 147 | 157.5 | 168 | 178.5 | 189 | 199.5 | 210 | 220.5 | 231 | 241.5 | 252 |

Dimensions: SV2000 Series for EX500 Gateway Decentralized System 2 (128 Points)

● Tie-rod base manifold

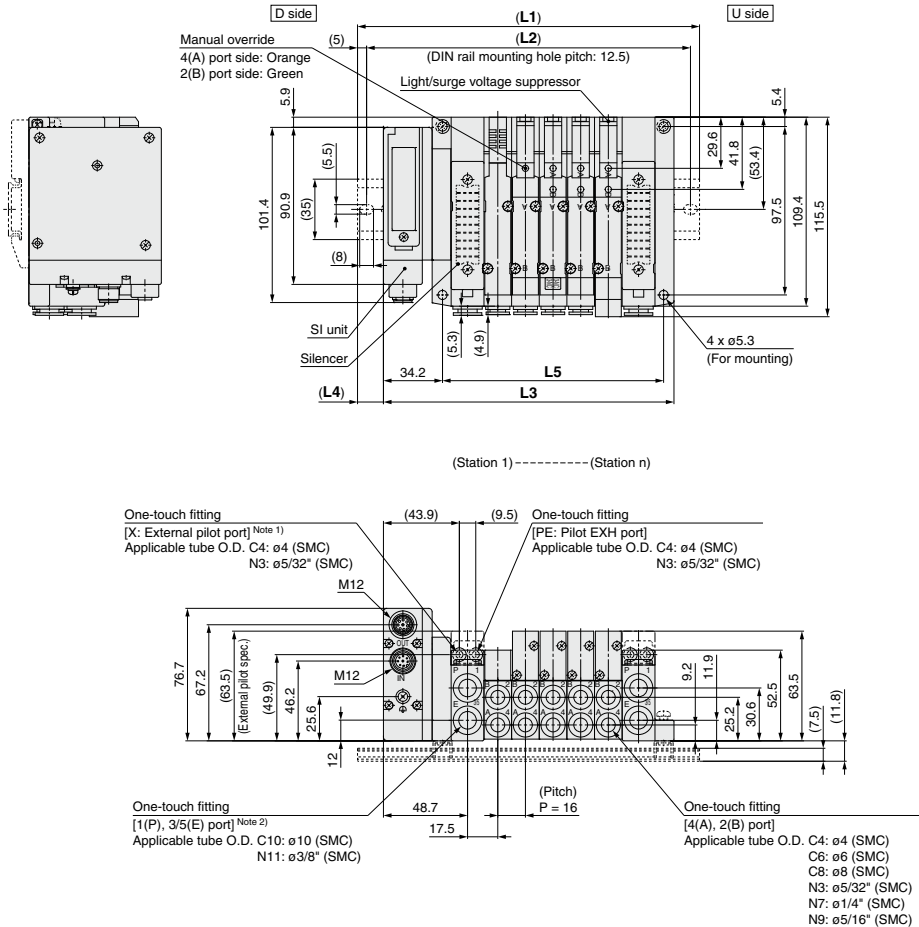

Note 1) External pilot port positions and silencer discharge port positions are the same as P, E port outlet positions.
Note 2) When P, E port outlets are indicated on the U side or D side, the P, E ports on the opposite side are plugged.

L: DIN Rail Overall Length

| L \ n | 2 | 3 | 4 | 5 | 6 | 7 | 8 | 9 | 10 | 11 | 12 | 13 | 14 | 15 | 16 | 17 | 18 | 19 | 20 |
|-------|-------|-------|-------|-------|-------|-------|-------|-------|-------|-------|-------|-------|-------|-------|-------|-------|-------|-------|-------|
| L1 | 148 | 160.5 | 185.5 | 198 | 210.5 | 235.5 | 248 | 260.5 | 273 | 298 | 310.5 | 323 | 335.5 | 360.5 | 373 | 385.5 | 410.5 | 423 | 435.5 |
| L2 | 137.5 | 150 | 175 | 187.5 | 200 | 225 | 237.5 | 250 | 262.5 | 287.5 | 300 | 312.5 | 325 | 350 | 362.5 | 375 | 400 | 412.5 | 425 |
| L3 | 120.2 | 136.2 | 152.2 | 168.2 | 184.2 | 200.2 | 216.2 | 232.2 | 248.2 | 264.2 | 280.2 | 296.2 | 312.2 | 328.2 | 344.2 | 360.2 | 376.2 | 392.2 | 408.2 |
| L4 | 14 | 12 | 16.5 | 15 | 13 | 17.5 | 16 | 14 | 12.5 | 17 | 15 | 13.5 | 11.5 | 16 | 14.5 | 12.5 | 17 | 15.5 | 13.5 |
| L5 | 80 | 96 | 112 | 128 | 144 | 160 | 176 | 192 | 208 | 224 | 240 | 256 | 272 | 288 | 304 | 320 | 336 | 352 | 368 |

n: Stations

EX500 (Gateway Decentralized System (64 Points)) Serial Transmission System

SV Series



How to Order Manifold

Series

| | |
|---|--------|
| 1 | SV1000 |
| 2 | SV2000 |
| 3 | SV3000 |
| 4 | SV4000 |

● Tie-rod base
SS5V **1** - W 10S **A2W** D - **05** U

● Cassette base
SS5V **1** - W 16S **A2W** D - **05** U

Series

| | |
|---|--------|
| 1 | SV1000 |
| 2 | SV2000 |

● Enclosure IP67 specifications

SI unit (Number of outputs, Output polarity, Max. number of valve stations, Protocol)

| | |
|-----|--|
| 0 | Without SI unit |
| A2W | 16 outputs, 2 to 8 stations (16 stations) (Note) |

(Note) (:): Maximum number of stations for mixed single and double wiring.

Valve stations

| Symbol | Stations | Note |
|--------|-------------|--|
| 02 | 2 stations | Double wiring specifications (1) |
| ⋮ | ⋮ | |
| 08 | 8 stations | Specified layout (2) (up to 16 solenoids possible.) |
| 02 | 2 stations | |
| ⋮ | ⋮ | |
| 16 | 16 stations | |

Note 1) Double wiring specifications: Single, double, 3 position and 4 position solenoid valves can be used on all manifold stations. Use of a single solenoid will result in an unused control signal. If this is not desired, order with a specified layout.

Note 2) Specified layout: Indicate wiring specifications on the manifold specification sheet. (Note that double, 3 position and 4 position valves cannot be used where single solenoid wiring has been specified.)

SI unit part no. EX500-S001

● Mounting

| | |
|-----|--------------------------------------|
| Nil | Direct mounting |
| D | DIN rail mounting (With DIN rail) |
| D0 | DIN rail mounting (Without DIN rail) |
| D3 | For 3 stations |
| ⋮ | ⋮ |
| D16 | For 16 stations |

* In the case of D0, only DIN rail fittings are attached.

● DIN rail length specified

| | |
|----|-----------------|
| 3 | Standard length |
| ⋮ | ⋮ |
| 16 | For 16 stations |

P, E port location

| | |
|---|-------------------------------|
| U | U side (2 to 10 stations) |
| D | D side (2 to 10 stations) |
| B | Both sides (2 to 16 stations) |

SUP/EXH block assembly specifications

| | |
|-----|----------------------------------|
| Nil | Internal pilot |
| S | Internal pilot/Built-in silencer |
| R | External pilot |
| RS | External pilot/Built-in silencer |

(Note) When the built-in silencer type is used, keep the exhaust port from coming in direct contact with water or other liquids.

A, B port size (metric)

| Symbol | A, B port | P, E port | Applicable series |
|--------|----------------------------|---------------------------|-------------------|
| C3 | One-touch fitting for ø3.2 | One-touch fitting for ø8 | SV1000 |
| C4 | One-touch fitting for ø4 | | |
| C6 | One-touch fitting for ø6 | | |
| C4 | One-touch fitting for ø4 | One-touch fitting for ø10 | SV2000 |
| C6 | One-touch fitting for ø6 | | |
| C8 | One-touch fitting for ø8 | One-touch fitting for ø12 | SV3000 |
| C6 | One-touch fitting for ø6 | | |
| C8 | One-touch fitting for ø8 | One-touch fitting for ø12 | SV4000 |
| C10 | One-touch fitting for ø10 | | |
| C12 | One-touch fitting for ø12 | Rc 3/8 | SV4000 |
| 02 | Rc 1/4 | | |
| 03 | Rc 3/8 | | |
| 02F | G 1/4 | | |
| 03F | G 3/8 | | |
| M | A, B ports mixed | | |

A, B port size (inch)

| Symbol | A, B port | P, E port | Applicable series |
|--------|------------------------------|------------------------------|-------------------|
| N1 | One-touch fitting for ø1/8" | One-touch fitting for ø5/16" | SV1000 |
| N3 | One-touch fitting for ø5/32" | | |
| N7 | One-touch fitting for ø1/4" | | |
| N3 | One-touch fitting for ø5/32" | One-touch fitting for ø3/8" | SV2000 |
| N7 | One-touch fitting for ø1/4" | | |
| N9 | One-touch fitting for ø5/16" | One-touch fitting for ø3/8" | SV3000 |
| N7 | One-touch fitting for ø1/4" | | |
| N9 | One-touch fitting for ø5/16" | One-touch fitting for ø3/8" | SV4000 |
| N11 | One-touch fitting for ø3/8" | | |
| N11 | One-touch fitting for ø5/16" | NPTF 3/8 | SV4000 |
| N11 | One-touch fitting for ø3/8" | | |
| 02N | NPT 1/4 | | |
| 03N | NPT 3/8 | NPTF 3/8 | SV4000 |
| 02T | NPTF 1/4 | | |
| 03T | NPTF 3/8 | | |
| M | A, B ports mixed | | |

* A separate GW unit and communication cable are required.

For details about the EX500 series, refer to the **Web Catalog** and the Operation Manual. Please download the Operation Manual via SMC website, <https://www.smworld.com>

* In the case of mixed specifications (M), indicate separately on the manifold specification sheet.
* Port sizes of X, PE port for external pilot specifications (R, RS) are ø4 (metric), ø5/32" (inch) for SV1000/2000 and ø6 (metric) and ø1/4" (inch) for SV3000/4000.



SV Series

How to Order Manifold Assembly

Ordering example (SV1000)

Manifold

SS5V1-W16SA2WD-06B-C6 (1 set)

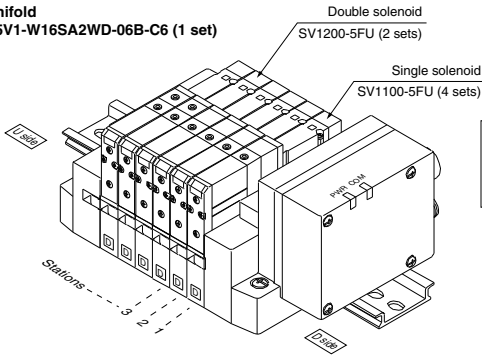

SS5V1-W16SA2WD-06B-C6.....1 set (Manifold part no.)
 * SV1100-5FU.....4 sets (Single solenoid part no.)
 * SV1200-5FU.....2 sets (Double solenoid part no.)

How to Order Valve

SV 1 1 0 0 - 5 F - - -

Series

| | |
|---|--------|
| 1 | SV1000 |
| 2 | SV2000 |
| 3 | SV3000 |
| 4 | SV4000 |

Type of actuation

| | |
|---|---|
| 1 | 2 position single |
| 2 | 2 position double |
| 3 | 3 position closed center |
| 4 | 3 position exhaust center |
| 5 | 3 position pressure center |
| A | 4 position dual 3 port valve: N.C./N.C. |
| B | 4 position dual 3 port valve: N.O./N.O. |
| C | 4 position dual 3 port valve: N.C./N.O. |

* 4 position dual 3 port valves are applicable to the SV1000 and SV2000 series only.

Pilot type

| | |
|-----|----------------|
| Nil | Internal pilot |
| R | External pilot |

* External pilot specifications is not available for 4 position dual 3 port valves.

Back pressure check valve

| | |
|-----|----------|
| Nil | None |
| K | Built-in |

* Built-in back pressure check valve type is applicable to the SV1000 series only.

* Back pressure check valve is not available for 3 position valve.

Rated voltage

| | |
|---|--------|
| 5 | 24 VDC |
|---|--------|

Note) Available with manifold block for station additions. Refer to pages 113 and 119.

Made to Order

| | |
|-----|--|
| Nil | - |
| X90 | Main valve fluororubber (Refer to page 134.) |

Manual override

Nil: Non-locking push type

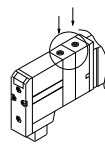

D: Push-turn locking slotted type

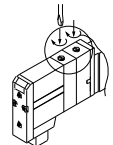

Light/Surge voltage suppressor

| | |
|---|-------------------------------------|
| U | With light/surge voltage suppressor |
| R | With surge voltage suppressor |

Note) Refer to Specific Product Precautions 2 on page 136.

Dimensions: SV1000 Series for EX500 Gateway Decentralized System (64 points)

● **Cassette base manifold: SS5V1-W16SA2WD-** Stations $\frac{U}{D}$ (S, R, RS) $\frac{C3, N1}{C4, N3}$ $\frac{C2, N2}{C5, N5}$

- When P, E port outlets are indicated on the U side or D side, the P, E ports on the opposite side are plugged.
- External pilot port positions and silencer discharge port positions are the same as P, E port outlet positions.

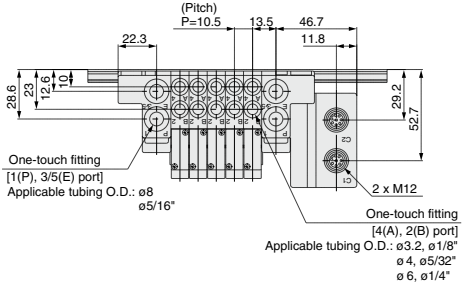

With External Pilot Specifications

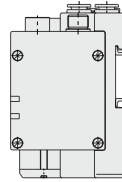
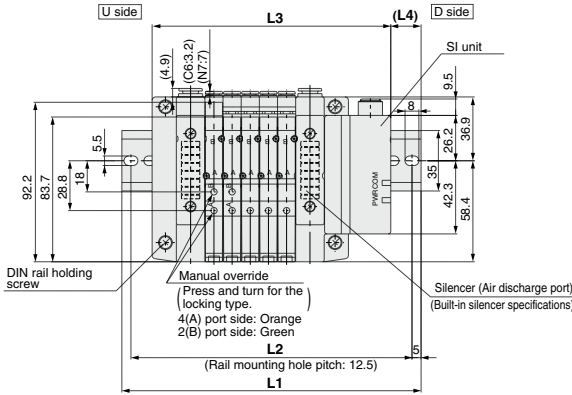
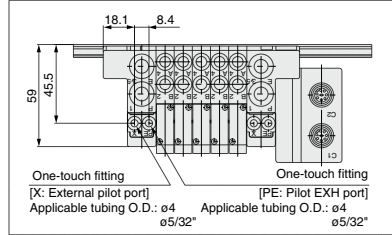

With option

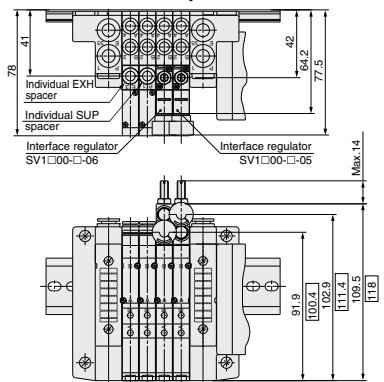

□ Dimensions are the ones for SV1300-□-□-□.

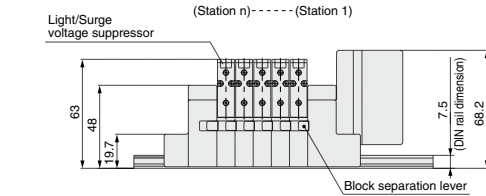

L Dimension

| n | 2 | 3 | 4 | 5 | 6 | 7 | 8 | 9 | 10 | 11 | 12 | 13 | 14 | 15 | 16 |
|----|-------|-------|-------|-------|-------|-------|-------|-------|-------|-------|-------|-------|-------|-------|-------|
| L1 | 135.5 | 148 | 160.5 | 173 | 173 | 185.5 | 198 | 210.5 | 223 | 235.5 | 235.5 | 248 | 260.5 | 273 | 285.5 |
| L2 | 125 | 137.5 | 150 | 162.5 | 162.5 | 175 | 187.5 | 200 | 212.5 | 225 | 225 | 237.5 | 250 | 262.5 | 275 |
| L3 | 106.5 | 117 | 127.5 | 138 | 148.5 | 159 | 169.5 | 180 | 190.5 | 201 | 211.5 | 222 | 232.5 | 243 | 253.5 |
| L4 | 14.5 | 15.5 | 16.5 | 17.5 | 12.5 | 13.5 | 14.5 | 15.5 | 16.5 | 17.5 | 12 | 13 | 14 | 15 | 16 |

n: Stations

SV Series

Dimensions: SV2000 Series for EX500 Gateway Decentralized System (64 points)

● Cassette base manifold: SS5V2-W16SA2WD-^UStations₆ (S, R, RS) ^{C4, N3}_{C6, N7}^{C4, N3}_{C6, N7}

- When P, E port outlets are indicated on the U side or D side, the P, E ports on the opposite side are plugged.
- External pilot port positions and silencer discharge port positions are the same as P, E port outlet positions.

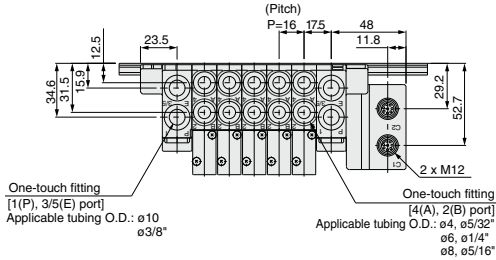

With External Pilot Specifications

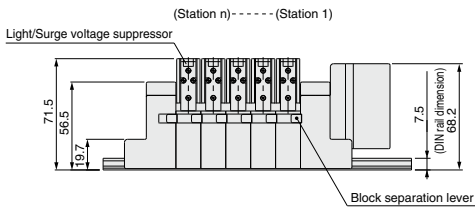
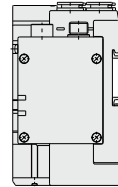
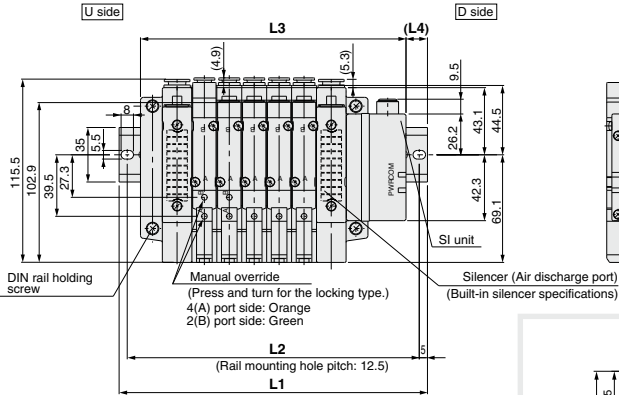
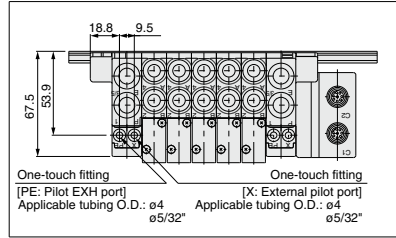

With option

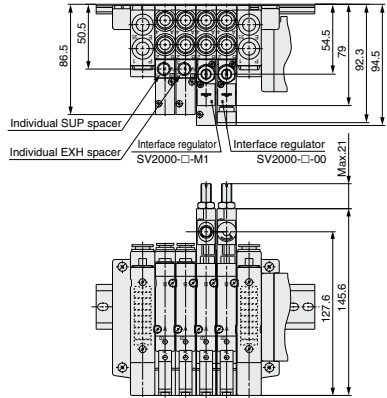

L Dimension

| n | 2 | 3 | 4 | 5 | 6 | 7 | 8 | 9 | 10 | 11 | 12 | 13 | 14 | 15 | 16 |
|----|-------|-------|-------|-------|-------|-------|-------|-------|-------|-------|-------|-------|-------|-------|-------|
| L1 | 148 | 173 | 185.5 | 198 | 210.5 | 235.5 | 248 | 260.5 | 285.5 | 298 | 310.5 | 323 | 348 | 360.5 | 373 |
| L2 | 137.5 | 162.5 | 175 | 187.5 | 200 | 225 | 237.5 | 250 | 275 | 287.5 | 300 | 312.5 | 337.5 | 350 | 362.5 |
| L3 | 122.5 | 138.5 | 154.5 | 170.5 | 186.5 | 202.5 | 218.5 | 234.5 | 250.5 | 266.5 | 282.5 | 298.5 | 314.5 | 330.5 | 346.5 |
| L4 | 13 | 17.5 | 15.5 | 14 | 12 | 16.5 | 15 | 13 | 17.5 | 16 | 14 | 12.5 | 17 | 15 | 13.5 |

Dimensions: SV1000 Series for EX500 Gateway Decentralized System (64 points)

● Tie-rod base manifold: SS5V1-W10SA2WD- $\frac{U}{D}$ (S, R, RS) $\frac{C3, N1}{C4, N5}$ $\frac{C6, N6}{C6, N6}$ (-D)

- When P, E port outlets are indicated on the U side or D side, the P, E ports on the opposite side are plugged.
- External pilot port positions and silencer discharge port positions are the same as P, E port outlet positions.

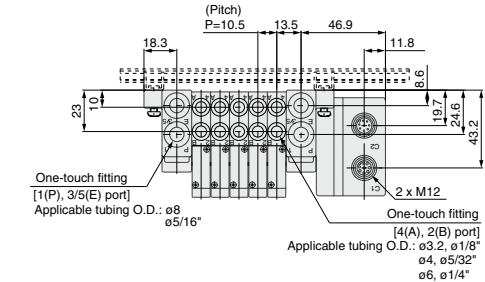

With External Pilot Specifications

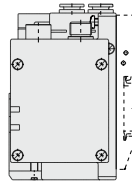
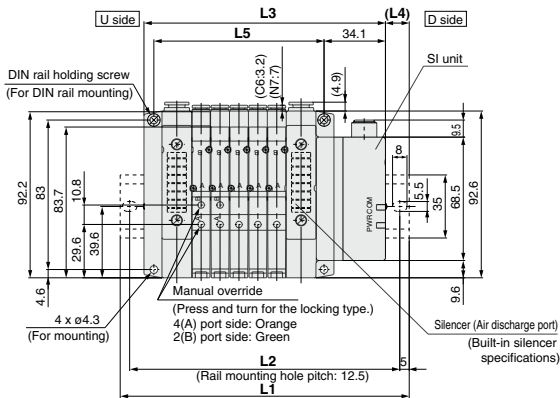
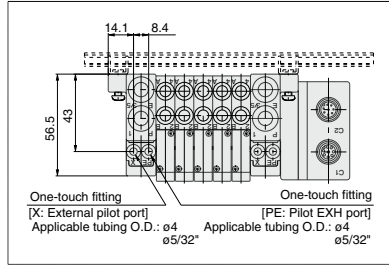

With option

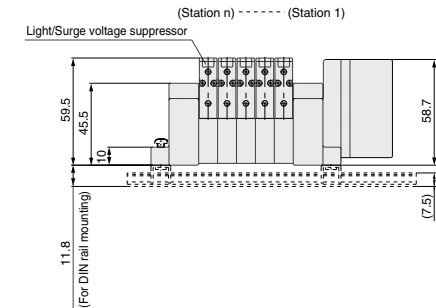
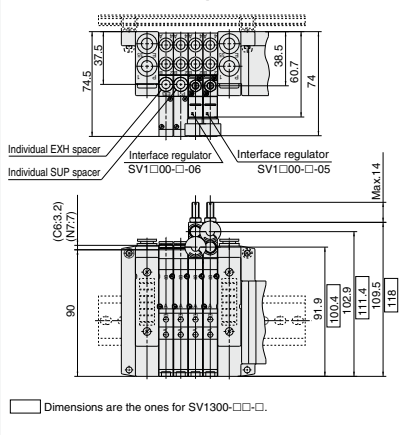

L Dimension

| n | 2 | 3 | 4 | 5 | 6 | 7 | 8 | 9 | 10 | 11 | 12 | 13 | 14 | 15 | 16 |
|----|-------|-------|-------|-------|-------|-------|-------|-------|-------|-------|-------|-------|-------|-------|-------|
| L1 | 135.5 | 148 | 148 | 160.5 | 173 | 185.5 | 198 | 210.5 | 210.5 | 223 | 235.5 | 248 | 260.5 | 273 | 273 |
| L2 | 125 | 137.5 | 137.5 | 150 | 162.5 | 175 | 187.5 | 200 | 200 | 212.5 | 225 | 237.5 | 250 | 262.5 | 262.5 |
| L3 | 102.6 | 113.1 | 123.6 | 134.1 | 144.6 | 155.1 | 165.6 | 176.1 | 186.6 | 197.1 | 207.6 | 218.1 | 228.6 | 239.1 | 249.6 |
| L4 | 16.5 | 17.5 | 12 | 13 | 14 | 15 | 16 | 17 | 12 | 13 | 14 | 15 | 16 | 17 | 11.5 |
| L5 | 63 | 73.5 | 84 | 94.5 | 105 | 115.5 | 126 | 136.5 | 147 | 157.5 | 168 | 178.5 | 189 | 199.5 | 210 |

SV Series

Dimensions: SV2000 Series for EX500 Gateway Decentralized System (64 points)

● Tie-rod base manifold: SS5V2-W10SA2WD-^UStations_D(S, R, RS)-^{C4, N3, C6, N7, C8, N8}(-D)

- When P, E port outlets are indicated on the U side or D side, the P, E ports on the opposite side are plugged.
- External pilot port positions and silencer discharge port positions are the same as P, E port outlet positions.

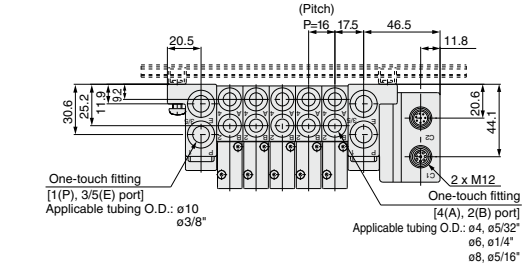

With External Pilot Specifications

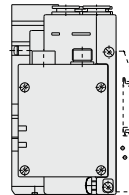
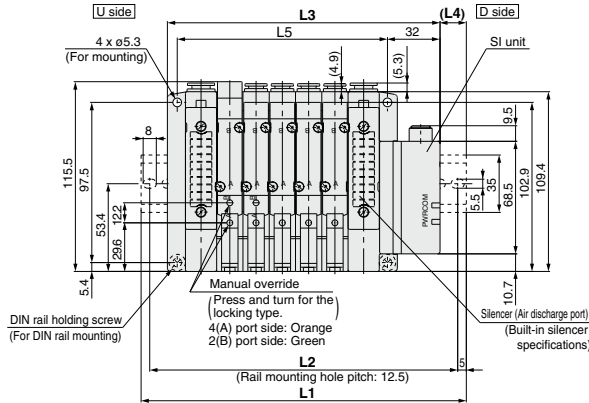
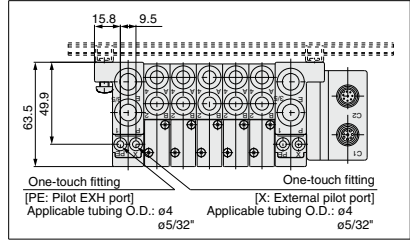

With option

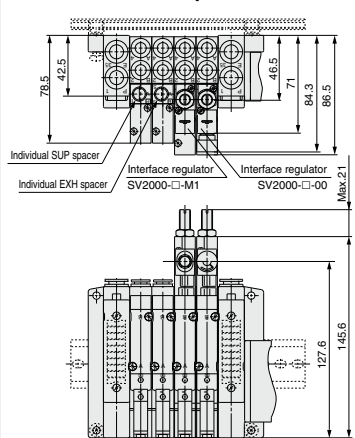

L Dimension

| n | 2 | 3 | 4 | 5 | 6 | 7 | 8 | 9 | 10 | 11 | 12 | 13 | 14 | 15 | 16 |
|----|-------|-------|-------|-------|-------|-------|-------|-------|-------|-------|-------|-------|-------|-------|-------|
| L1 | 148 | 160.5 | 185.5 | 198 | 210.5 | 223 | 248 | 260.5 | 273 | 285.5 | 310.5 | 323 | 335.5 | 360.5 | 373 |
| L2 | 137.5 | 150 | 175 | 187.5 | 200 | 212.5 | 237.5 | 250 | 262.5 | 275 | 300 | 312.5 | 325 | 350 | 362.5 |
| L3 | 118 | 134 | 150 | 166 | 182 | 198 | 214 | 230 | 246 | 262 | 278 | 294 | 310 | 326 | 342 |
| L4 | 15 | 13.5 | 18 | 16 | 14.5 | 12.5 | 17 | 15.5 | 13.5 | 12 | 16.5 | 14.5 | 13 | 17.5 | 15.5 |
| L5 | 80 | 96 | 112 | 128 | 144 | 160 | 176 | 192 | 208 | 224 | 240 | 256 | 272 | 288 | 304 |

n: Stations

Dimensions: SV3000 Series for EX500 Gateway Decentralized System (64 Points)

● Tie-rod base manifold: SS5V3-W10SA2WD- $\frac{U}{S}$ (S, R, RS) $\frac{C6, N7}{C8, N9}$ (-D)

- When P, E port outlets are indicated on the U side or D side, the P, E ports on the opposite side are plugged.
- External pilot port positions and silencer discharge port positions are the same as P, E port outlet positions.

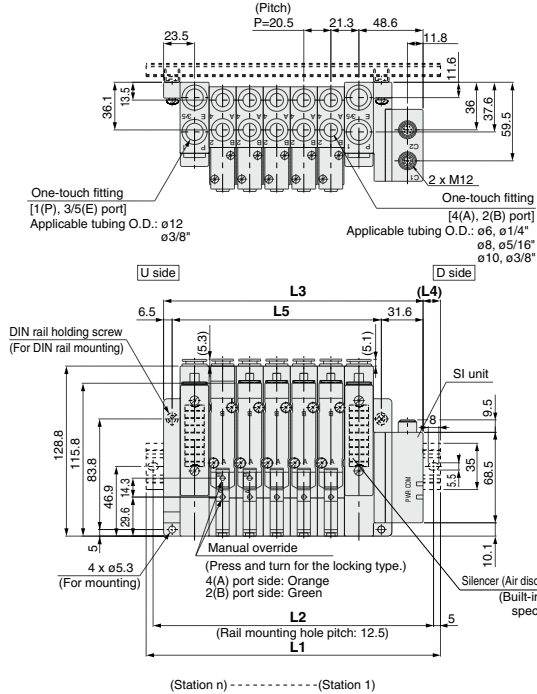

With External Pilot Specifications

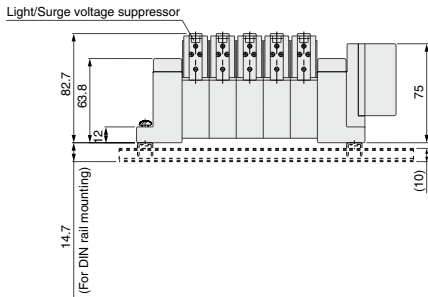
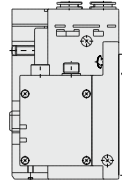
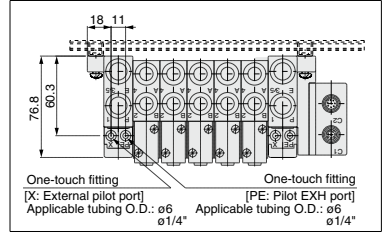

With option

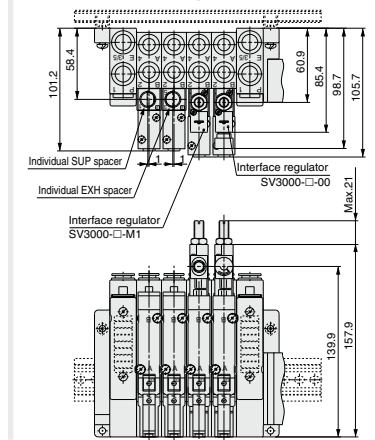

L Dimension

| n | 2 | 3 | 4 | 5 | 6 | 7 | 8 | 9 | 10 | 11 | 12 | 13 | 14 | 15 | 16 |
|----|-------|-------|-------|-------|-------|-------|-------|-------|-------|-------|-------|-------|-------|-------|-------|
| L1 | 160.5 | 185.5 | 210.5 | 223 | 248 | 273 | 285.5 | 310.5 | 323 | 348 | 373 | 385.5 | 410.5 | 435.5 | 448 |
| L2 | 150 | 175 | 200 | 212.5 | 237.5 | 262.5 | 275 | 300 | 312.5 | 337.5 | 362.5 | 375 | 400 | 425 | 437.5 |
| L3 | 135.1 | 155.6 | 176.1 | 196.6 | 217.1 | 237.6 | 258.1 | 278.6 | 299.1 | 319.6 | 340.1 | 360.6 | 381.1 | 401.6 | 422.1 |
| L4 | 12.5 | 15 | 17 | 13 | 15.5 | 17.5 | 13.5 | 16 | 12 | 14 | 16.5 | 12.5 | 14.5 | 17 | 13 |
| L5 | 97 | 117.5 | 138 | 158.5 | 179 | 199.5 | 220 | 240.5 | 261 | 281.5 | 302 | 322.5 | 343 | 363.5 | 384 |

n: Stations

SV Series

Dimensions: SV4000 Series for EX500 Gateway Decentralized System (64 points)

● Tie-rod base manifold: SS5V4-W10SA2WD-Stations₁ (S, R, RS) ^{02, C8, N9}/_{03, C10, C12, N11} (-D)

- When P, E port outlets are indicated on the U side or D side, the P, E ports on the opposite side are plugged.
- External pilot port positions and silencer discharge port positions are the same as P, E port outlet positions.

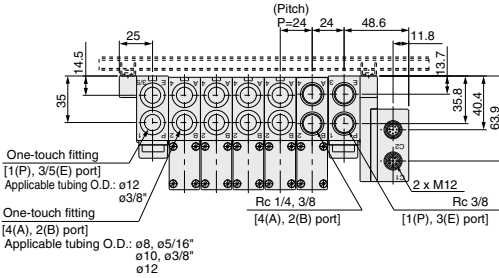

With External Pilot Specifications

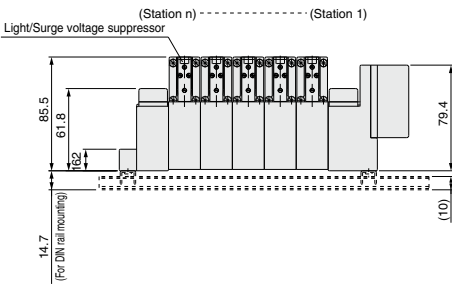
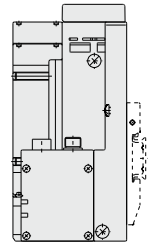
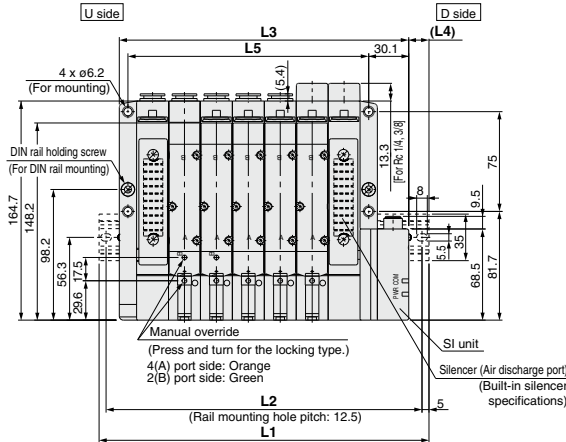
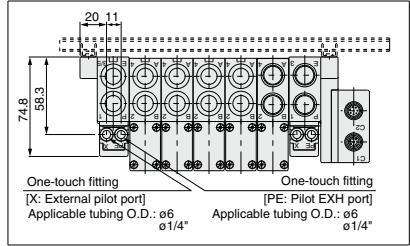

With option

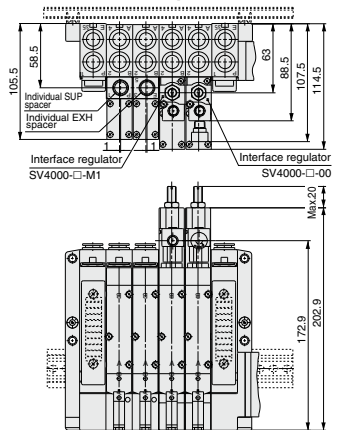

L Dimension

| n | 2 | 3 | 4 | 5 | 6 | 7 | 8 | 9 | 10 | 11 | 12 | 13 | 14 | 15 | 16 |
|----|-------|-------|-------|-------|-------|-------|-------|-------|-------|-------|-------|-------|-------|-------|-------|
| L1 | 173 | 198 | 223 | 248 | 273 | 298 | 323 | 348 | 373 | 385.5 | 410.5 | 435.5 | 460.5 | 485.5 | 510.5 |
| L2 | 162.5 | 187.5 | 212.5 | 237.5 | 262.5 | 287.5 | 312.5 | 337.5 | 362.5 | 375 | 400 | 425 | 450 | 475 | 500 |
| L3 | 145.6 | 169.6 | 193.6 | 217.6 | 241.6 | 265.6 | 289.6 | 313.6 | 337.6 | 361.6 | 385.6 | 409.6 | 433.6 | 457.6 | 481.6 |
| L4 | 13.5 | 14 | 14.5 | 15 | 15.5 | 16 | 16.5 | 17 | 17.5 | 12 | 12.5 | 13 | 13.5 | 14 | 14.5 |
| L5 | 109 | 133 | 157 | 181 | 205 | 229 | 253 | 277 | 301 | 325 | 349 | 373 | 397 | 421 | 445 |

Integrated-type (For I/O) Serial Transmission System

EX250 Series

IP67 (partly IP40) compliant

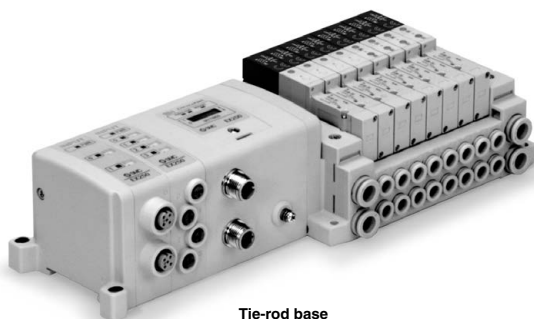

Tie-rod base

| | |
|-------------------|---|
| Applicable series | Tie-rod base manifold SV1000/SV2000/SV3000 |
|-------------------|---|

- Number of inputs/outputs points: 32 points each

EX250 Integrated-type (For I/O) Serial Transmission System

SV Series



PROFIBUS DP compatible products (SI unit specification: NW) are to be discontinued as of November 2022. As a substitute, please consider the use of an EX600 series product (SI unit specification: N). However, keep in mind that the product specifications, external appearance, etc., differ. For details, please contact your SMC sales representative.

How to Order Manifold

● Tie-rod base

SS5V 1 - W10S1 QW [] [] [] D - 05 U [] - [] - []

Series

| | |
|---|--------|
| 1 | SV1000 |
| 2 | SV2000 |
| 3 | SV3000 |

Enclosure
IP67

SI unit

| Symbol | Protocol type |
|--------------------|---|
| 0 | Without SI unit |
| QW | DeviceNet® |
| NW | PROFIBUS DP |
| TAW | AS-Interface (8in/8out 31Slave Mode 2 power supply systems) |
| TBW | AS-Interface (4in/4out 31Slave Mode 2 power supply systems) |
| TCW ⁽¹⁾ | AS-Interface (8in/8out 31Slave Mode 1 power supply systems) |
| TDW ⁽¹⁾ | AS-Interface (4in/4out 31Slave Mode 1 power supply systems) |
| YW | CANopen |
| ZEN | EtherNet/IP |

- Input blocks cannot be mounted without SI unit.
- When the DIN rail is included without an SI unit, the DIN rail length will accommodate an SI unit and one input block.

Note 1) There is a limit to the supply current to the input block and valve from SI units that have AS-Interface-compliant 1 power supply systems. Refer to the **Web Catalog** for details.

Input block stations

| Nil | None |
|-----|------------|
| 1 | 1 station |
| : | : |
| 8 | 8 stations |

Note) Without SI unit, the symbol is nil. When the SI unit is AS Interface compliant, the maximum number of stations is limited. Refer to the **Web Catalog** for details.

Input block type

| Nil | Without input block |
|-----|-------------------------|
| 1 | M12: 2 inputs EX250-IE1 |
| 2 | M12: 4 inputs EX250-IE2 |
| 3 | M8: 4 inputs EX250-IE3 |

Note) Without SI unit, the symbol is nil.

Input block specifications

| Nil | PNP sensor input (Positive common) or without input block |
|-----|---|
| N | NPN sensor input (Negative common) |

Mounting

| Nil | Direct mounting |
|-----|--------------------------------------|
| D | DIN rail mounting (With DIN rail) |
| D0 | DIN rail mounting (Without DIN rail) |
| D3 | For 3 stations |
| : | : |
| D20 | For 20 stations |

* In the case of D0, only DIN rail fittings are attached.

SUP/EXH block assembly specifications

| Nil | Internal pilot |
|-----|----------------------------------|
| S | Internal pilot/Built-in silencer |
| R | External pilot |
| RS | External pilot/Built-in silencer |

Note) When the built-in silencer type is used, keep the exhaust port from coming in direct contact with water or other liquids.

● P, E port location

| U | U side (2 to 10 stations) |
|---|-------------------------------|
| D | D side (2 to 10 stations) |
| B | Both sides (2 to 20 stations) |

● Valve stations

| Symbol | Stations | Note |
|--------|-------------|--|
| 02 | 2 stations | Double wiring specifications (1) |
| : | : | |
| 16 | 16 stations | |
| 02 | 2 stations | Specified layout (2) (up to 32 solenoids possible.) |
| : | : | |
| 20 | 20 stations | |

* When the SI unit is AS-Interface compliant, the maximum number of solenoids is as shown below, so please be careful of the number of stations.

- 8in/8out: Max. 8 solenoids
- 4in/4out: Max. 4 solenoids
- Note 1) Double wiring specifications: Single, double, 3 position and 4 position solenoid valves can be used on all manifold stations. Use of a single solenoid will result in an unused control signal. If this is not desired, order with a specified layout.
- Note 2) Specified layout: Indicate wiring specifications on the manifold specification sheet. (Note that double, 3 and 4 position valves cannot be used where single solenoid wiring has been specified.)

SI Unit Part No.

| Symbol | Protocol type | Solenoid part no. |
|--------|---|-------------------|
| QW | DeviceNet® | EX250-SDN1 |
| NW | PROFIBUS DP | EX250-SPR1 |
| TAW | AS-Interface (8in/8out 31Slave Mode 2 power supply systems) | EX250-SA63 |
| TBW | AS-Interface (4in/4out 31Slave Mode 2 power supply systems) | EX250-SA5 |
| TCW | AS-Interface (8in/8out 31Slave Mode 1 power supply systems) | EX250-SA7 |
| TDW | AS-Interface (4in/4out 31Slave Mode 1 power supply systems) | EX250-SA9 |
| YW | CANopen | EX250-SCA1A |
| ZEN | EtherNet/IP | EX250-SEN1 |

A, B port size (metric)

| Symbol | A, B port | P, E port | Applicable series |
|--------|----------------------------|---------------------------|-------------------|
| C3 | One-touch fitting for ø3.2 | One-touch fitting for ø8 | SV1000 |
| C4 | One-touch fitting for ø4 | | |
| C6 | One-touch fitting for ø6 | One-touch fitting for ø10 | SV2000 |
| C4 | One-touch fitting for ø4 | | |
| C6 | One-touch fitting for ø6 | One-touch fitting for ø8 | SV3000 |
| C8 | One-touch fitting for ø8 | | |
| C8 | One-touch fitting for ø8 | One-touch fitting for ø12 | SV3000 |
| C10 | One-touch fitting for ø10 | | |
| M | A, B ports mixed | | |

A, B port size (inch)

| Symbol | A, B port | P, E port | Applicable series |
|--------|------------------------------|------------------------------|-------------------|
| N1 | One-touch fitting for ø1/8" | One-touch fitting for ø5/16" | SV1000 |
| N3 | One-touch fitting for ø5/32" | | |
| N7 | One-touch fitting for ø1/4" | One-touch fitting for ø3/8" | SV2000 |
| N3 | One-touch fitting for ø5/32" | | |
| N7 | One-touch fitting for ø1/4" | One-touch fitting for ø5/16" | SV3000 |
| N9 | One-touch fitting for ø5/16" | | |
| N7 | One-touch fitting for ø1/4" | One-touch fitting for ø3/8" | SV3000 |
| N9 | One-touch fitting for ø5/16" | | |
| N11 | One-touch fitting for ø3/8" | | |
| M | A, B ports mixed | | |

* In the case of mixed specifications (M), indicate separately on the manifold specification sheet.

* Port sizes of X, PE port for external pilot specifications (R, RS) are ø4 (metric), ø5/32" (inch) for SV1000/2000 and ø6 (metric) and ø1/4" (inch) for SV3000.

Refer to the **Web Catalog** and the Operation Manual for the details of EX250 Integrated-type Serial Transmission System. Please download the Operation Manual via our website, <https://www.smccworld.com>.

How to Order Manifold Assembly

Ordering example (SV1000)

Manifold

SS5V1-W10S1QW11ND-05B-C6 (1 set)

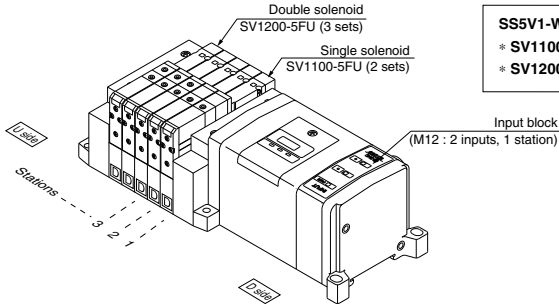

SS5V1-W10S1QW11ND-05B-C6...1 set (manifold part no.)

* SV1100-5FU.....2 sets (Single solenoid part no.)

* SV1200-5FU.....3 sets (Double solenoid part no.)

How to Order Valve

SV 1 1 0 0 - 5 F - - - (Note)

Series

| | |
|---|--------|
| 1 | SV1000 |
| 2 | SV2000 |
| 3 | SV3000 |

Type of actuation

| | |
|---|---|
| 1 | 2 position single |
| 2 | 2 position double |
| 3 | 3 position closed center |
| 4 | 3 position exhaust center |
| 5 | 3 position pressure center |
| A | 4 position dual 3 port valve: N.C./N.C. |
| B | 4 position dual 3 port valve: N.O./N.O. |
| C | 4 position dual 3 port valve: N.C./N.O. |

* 4 position dual 3 port valves are applicable to the SV1000 and SV2000 series only.

Pilot type

| | |
|-----|----------------|
| Nil | Internal pilot |
| R | External pilot |

* External pilot specifications is not available for 4 position dual 3 port valves.

Back pressure check valve

| | |
|-----|----------|
| Nil | None |
| K | Built-in |

* Built-in back pressure check valve type is applicable to the SV1000 series only.
* Back pressure check valve is not available for 3 position valve.

Note) Available with manifold block for station additions. Refer to page 119.

Made to Order

| | |
|-----|--|
| Nil | - |
| X90 | Main valve fluororubber (Refer to page 134.) |

Manual override

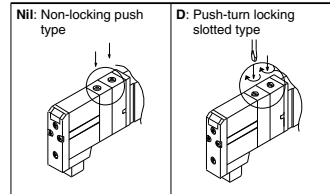

Light/Surge voltage suppressor

| | |
|---|-------------------------------------|
| U | With light/surge voltage suppressor |
| R | With surge voltage suppressor |

Rated voltage

| | |
|---|--------|
| 5 | 24 VDC |
|---|--------|

Note) Refer to Specific Product Precautions 2 on page 136.

SV Series

Dimensions: SV1000 Series for EX250 Integrated-type (For I/O) Serial Transmission System

● Tie-rod base manifold: SS5V1-W10S1□□□□□□-Stations $\frac{U}{D}$ (S, R, RS)-C3, N1
C4, N3 (-D)
C6, N7

- When P, E port outlets are indicated on the U side or D side, the P, E ports on the opposite side are plugged.
- External pilot port positions and silencer discharge port positions are the same as P, E port outlet positions.

(With 2 input blocks)

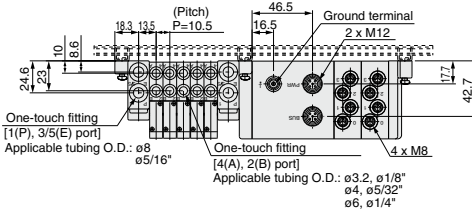

With External Pilot Specifications

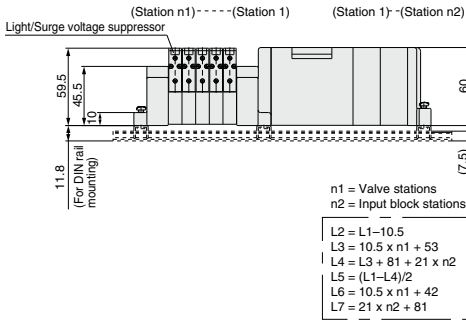
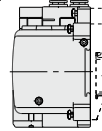
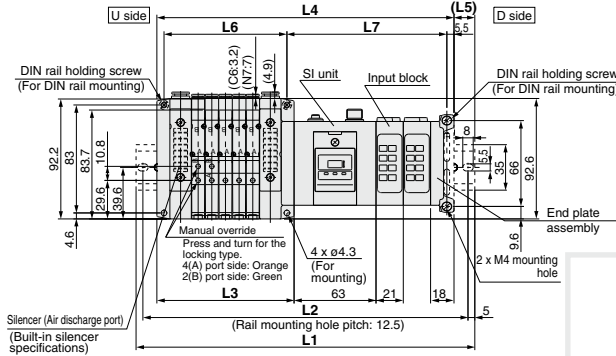
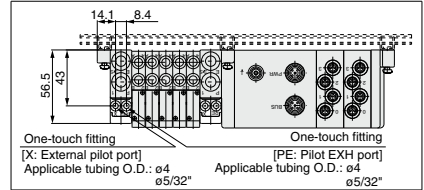

With option

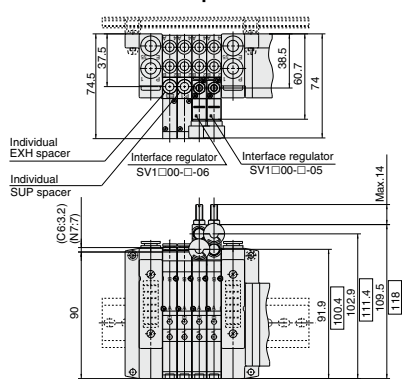

□ Dimensions are the ones for SV1300-□□□□.

L1: DIN Rail Overall Length

| Valve stations (n1) Input block Stations (n2) | 2 | 3 | 4 | 5 | 6 | 7 | 8 | 9 | 10 | 11 | 12 | 13 | 14 | 15 | 16 | 17 | 18 | 19 | 20 |
|---|-------|-------|-------|-------|-------|-------|-------|-------|-------|-------|-------|-------|-------|-------|-------|-------|-------|-------|-------|
| 0 | 185.5 | 198 | 210.5 | 210.5 | 223 | 235.5 | 248 | 260.5 | 273 | 273 | 285.5 | 298 | 310.5 | 323 | 335.5 | 348 | 348 | 360.5 | 373 |
| 1 | 210.5 | 210.5 | 223 | 235.5 | 248 | 260.5 | 273 | 273 | 285.5 | 298 | 310.5 | 323 | 335.5 | 348 | 348 | 360.5 | 373 | 385.5 | 398 |
| 2 | 223 | 235.5 | 248 | 260.5 | 273 | 273 | 285.5 | 298 | 310.5 | 323 | 335.5 | 348 | 348 | 360.5 | 373 | 385.5 | 398 | 410.5 | 410.5 |
| 3 | 248 | 260.5 | 273 | 273 | 285.5 | 298 | 310.5 | 323 | 335.5 | 348 | 348 | 360.5 | 373 | 385.5 | 398 | 410.5 | 410.5 | 423 | 435.5 |
| 4 | 273 | 273 | 285.5 | 298 | 310.5 | 323 | 335.5 | 348 | 348 | 360.5 | 373 | 385.5 | 398 | 410.5 | 410.5 | 423 | 435.5 | 448 | 460.5 |
| 5 | 285.5 | 298 | 310.5 | 323 | 335.5 | 348 | 348 | 360.5 | 373 | 385.5 | 398 | 410.5 | 410.5 | 423 | 435.5 | 448 | 460.5 | 473 | 473 |
| 6 | 310.5 | 323 | 335.5 | 348 | 348 | 360.5 | 373 | 385.5 | 398 | 410.5 | 410.5 | 423 | 435.5 | 448 | 460.5 | 473 | 473 | 485.5 | 498 |
| 7 | 335.5 | 348 | 348 | 360.5 | 373 | 385.5 | 398 | 410.5 | 410.5 | 423 | 435.5 | 448 | 460.5 | 473 | 473 | 485.5 | 498 | 510.5 | 523 |
| 8 | 348 | 360.5 | 373 | 385.5 | 398 | 410.5 | 410.5 | 423 | 435.5 | 448 | 460.5 | 473 | 473 | 485.5 | 498 | 510.5 | 523 | 535.5 | 535.5 |

Dimensions: SV2000 Series for EX250 Integrated-type (For I/O) Serial Transmission System

● Tie-rod base manifold: SS5V2-W10S1□□□□D-**Stations** $\frac{U}{B}$ (S, R, RS)- $\frac{C4, N3}{C8, N1}$ / $\frac{C8, N9}{C8, N9}$ (-D)

(With 2 input blocks)

- When P, E port outlets are indicated on the U side or D side, the P, E ports on the opposite side are plugged.
- External pilot port positions and silencer discharge port positions are the same as P, E port outlet positions.

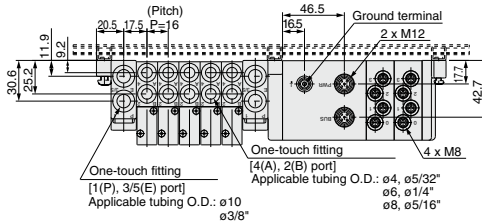

With External Pilot Specifications

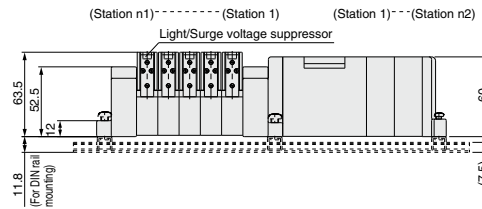
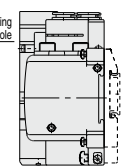
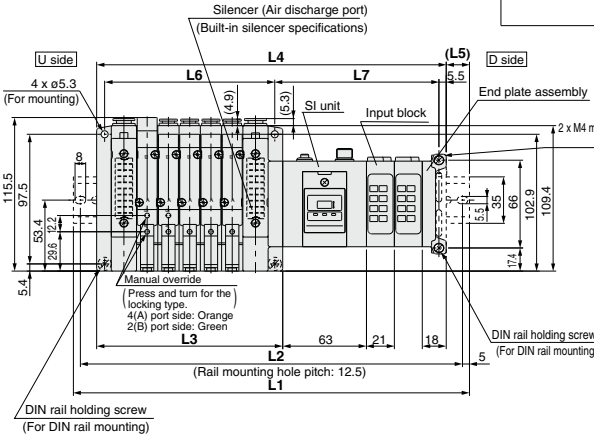
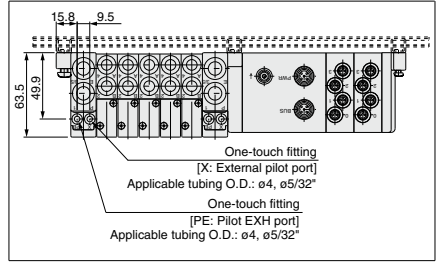

With option

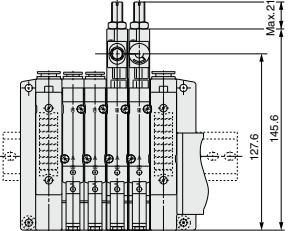
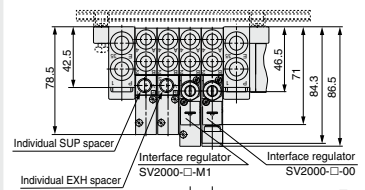

n1 = Valve stations
n2 = Input block stations

- L2 = L1 - 10.5
- L3 = 16 x n1 + 60
- L4 = L3 + 81 + 21 x n2
- L5 = (L1 - L4) / 2
- L6 = 16 x n1 + 48
- L7 = 21 x n2 + 81.5

L1: DIN Rail Overall Length

| Valve stations (n1) Input block Stations (n2) | 2 | 3 | 4 | 5 | 6 | 7 | 8 | 9 | 10 | 11 | 12 | 13 | 14 | 15 | 16 | 17 | 18 | 19 | 20 |
|--|-------|-------|-------|-------|-------|-------|-------|-------|-------|-------|-------|-------|-------|-------|-------|-------|-------|-------|-------|
| 0 | 198 | 223 | 235.5 | 248 | 260.5 | 285.5 | 298 | 310.5 | 335.5 | 348 | 360.5 | 373 | 398 | 410.5 | 423 | 448 | 460.5 | 473 | 485.5 |
| 1 | 223 | 235.5 | 260.5 | 273 | 285.5 | 298 | 323 | 335.5 | 348 | 373 | 385.5 | 398 | 410.5 | 435.5 | 448 | 460.5 | 485.5 | 498 | 510.5 |
| 2 | 248 | 260.5 | 273 | 298 | 310.5 | 323 | 335.5 | 360.5 | 373 | 385.5 | 410.5 | 423 | 435.5 | 448 | 473 | 485.5 | 498 | 510.5 | 535.5 |
| 3 | 260.5 | 285.5 | 298 | 310.5 | 335.5 | 348 | 360.5 | 373 | 398 | 410.5 | 423 | 435.5 | 460.5 | 473 | 485.5 | 510.5 | 523 | 535.5 | 548 |
| 4 | 285.5 | 298 | 323 | 335.5 | 348 | 360.5 | 385.5 | 398 | 410.5 | 435.5 | 448 | 460.5 | 473 | 498 | 510.5 | 523 | 548 | 560.5 | 573 |
| 5 | 310.5 | 323 | 335.5 | 360.5 | 373 | 385.5 | 398 | 423 | 435.5 | 448 | 473 | 485.5 | 498 | 510.5 | 535.5 | 548 | 560.5 | 585.5 | 598 |
| 6 | 323 | 348 | 360.5 | 373 | 398 | 410.5 | 423 | 435.5 | 460.5 | 473 | 485.5 | 510.5 | 523 | 535.5 | 548 | 573 | 585.5 | 598 | 610.5 |
| 7 | 348 | 360.5 | 385.5 | 398 | 410.5 | 435.5 | 448 | 460.5 | 473 | 498 | 510.5 | 523 | 535.5 | 560.5 | 573 | 585.5 | 610.5 | 623 | 635.5 |
| 8 | 373 | 385.5 | 398 | 423 | 435.5 | 448 | 460.5 | 485.5 | 498 | 510.5 | 535.5 | 548 | 560.5 | 573 | 598 | 610.5 | 623 | 648 | 660.5 |

SV Series

Dimensions: SV3000 Series for EX250 Integrated-type (For I/O) Serial Transmission System

● Tie-rod base manifold: SS5V3-W10S1□□□□D-**Stations** $\frac{U}{D}$ (S, R, RS)- $\frac{C6, N7}{C8, N9}$ $\frac{C10, N11}{(-D)}$

(With 2 input blocks)

- When P, E port outlets are indicated on the U side or D side, the P, E ports on the opposite side are plugged.
- External pilot port positions and silencer discharge port positions are the same as P, E port outlet positions.

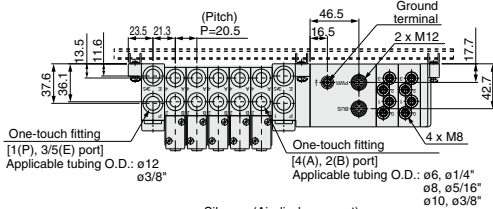

With External Pilot Specifications

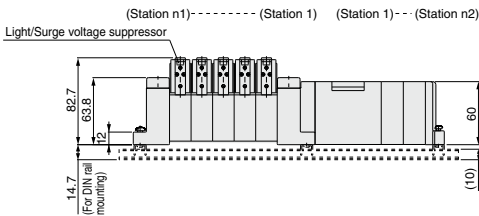
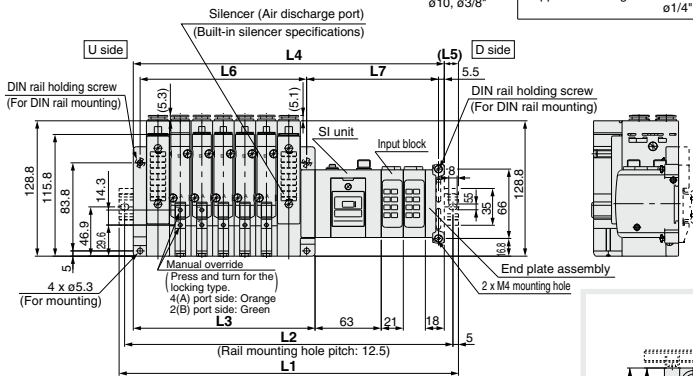
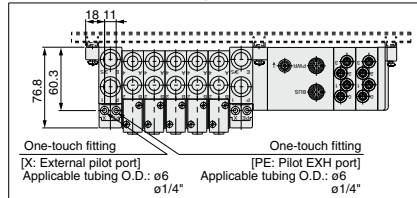

n1 = Valve stations
n2 = Input block stations

- L2 = L1 - 10.5
- L3 = 20.5 x n1 + 70.5
- L4 = L3 + 81 + 21 x n2
- L5 = (L1 - L4) / 2
- L6 = 20.5 x n1 + 56
- L7 = 21 x n2 + 83.5

With option

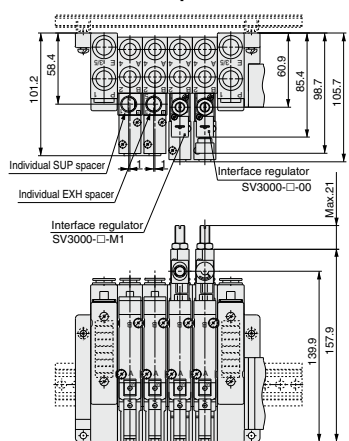

L1: DIN Rail Overall Length

| Valve stations (n1) Input block Stations (n2) | 2 | 3 | 4 | 5 | 6 | 7 | 8 | 9 | 10 | 11 | 12 | 13 | 14 | 15 | 16 | 17 | 18 | 19 | 20 |
|--|-------|-------|-------|-------|-------|-------|-------|-------|-------|-------|-------|-------|-------|-------|-------|-------|-------|-------|-------|
| 0 | 223 | 248 | 260.5 | 285.5 | 298 | 323 | 348 | 360.5 | 385.5 | 410.5 | 423 | 448 | 473 | 485.5 | 510.5 | 535.5 | 548 | 573 | 585.5 |
| 1 | 248 | 260.5 | 285.5 | 310.5 | 323 | 348 | 360.5 | 385.5 | 410.5 | 423 | 448 | 473 | 485.5 | 510.5 | 535.5 | 548 | 573 | 585.5 | 610.5 |
| 2 | 260.5 | 285.5 | 310.5 | 323 | 348 | 360.5 | 385.5 | 410.5 | 423 | 448 | 473 | 485.5 | 510.5 | 535.5 | 548 | 573 | 598 | 610.5 | 635.5 |
| 3 | 285.5 | 310.5 | 323 | 348 | 373 | 385.5 | 410.5 | 423 | 448 | 473 | 485.5 | 510.5 | 535.5 | 548 | 573 | 598 | 610.5 | 635.5 | 648 |
| 4 | 310.5 | 323 | 348 | 373 | 385.5 | 410.5 | 423 | 448 | 473 | 485.5 | 510.5 | 535.5 | 548 | 573 | 598 | 610.5 | 635.5 | 660.5 | 673 |
| 5 | 323 | 348 | 373 | 385.5 | 410.5 | 435.5 | 448 | 473 | 485.5 | 510.5 | 535.5 | 548 | 573 | 598 | 610.5 | 635.5 | 660.5 | 673 | 698 |
| 6 | 348 | 373 | 385.5 | 410.5 | 435.5 | 448 | 473 | 485.5 | 510.5 | 535.5 | 548 | 573 | 598 | 610.5 | 635.5 | 660.5 | 673 | 698 | 723 |
| 7 | 373 | 385.5 | 410.5 | 435.5 | 448 | 473 | 498 | 510.5 | 535.5 | 548 | 573 | 598 | 610.5 | 635.5 | 660.5 | 673 | 698 | 723 | 735.5 |
| 8 | 385.5 | 410.5 | 435.5 | 448 | 473 | 498 | 510.5 | 535.5 | 548 | 573 | 598 | 610.5 | 635.5 | 660.5 | 673 | 698 | 723 | 735.5 | 760.5 |

Integrated-type (For I/O) Serial Transmission System

EX600 Series

IP67 compliant

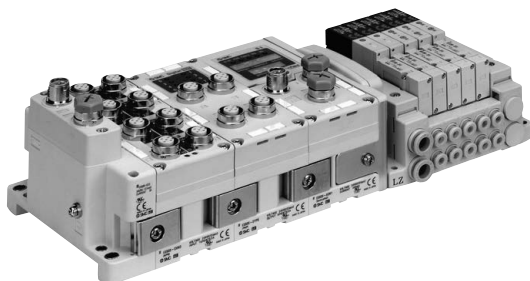

Tie-rod base

Applicable series **Tie-rod base manifold**
SV1000/SV2000/SV3000

- Digital input/output: Max. 144 inputs/144 outputs
- Analog input: Max. 18 channels
- Valve output: 32 outputs

Refer to the **Web Catalog** and the **Operation Manual** for the details of EX600 Integrated-type (For I/O) Serial Transmission System.
Please download the Operation Manual via our website, <https://www.smcworld.com>

EX600 Series



SV1000/2000/3000 Series

When I/O Unit EX600-D□□E or EX600-D□□F are selected, enclosure is IP40.
Refer to page 141 for details.

EtherCAT compatible products (SI unit specification/Symbol: D) are to be discontinued as of October 2022.
As a substitute, please consider the use of an EX260 series product (SI unit specification/Symbol: DA). However, keep in mind that the product specifications, external appearance, etc., differ. For details, please contact your SMC sales representative.

How to Order

● Tie-rod Base

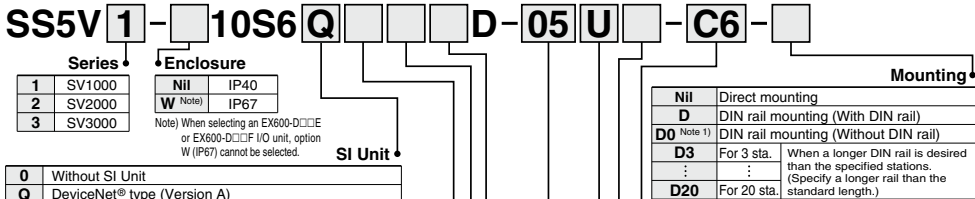

SI Unit

| | |
|-----------|--|
| 0 | Without SI Unit |
| Q | DeviceNet® type (Version A) |
| N | PROFIBUS DP type (Version A) |
| V | CC-Link type |
| EA | EtherNet/IP™ (2 port) |
| F | PROFINET type |
| D | EtherCAT type |
| WE | EtherNet/IP™ compatible wireless base (Note 3) |
| WF | PROFINET compatible wireless base (Note 3) |
| WS | Wireless remote (Note 3) |

Note 1) I/O units cannot be chosen without SI Unit.
Note 2) When "Without SI Unit" is specified, the valve plate to connect the manifold and SI unit is not mounted. For mounting method, refer to Specific Product Precautions of the **Web Catalog**.
Note 3) The wireless system is suitable for use only in a country where it is in accordance with the Radio Act and regulations of that country.

● End plate type

| | |
|------------|---|
| Nil | No end plate |
| 2 | M12 power supply connector B-coded |
| 3 | 7/8 inch power supply connector |
| 4 | M12 power supply connector IN/OUT, A-coded, Pin arrangement 1 |
| 5 | M12 power supply connector IN/OUT, A-coded, Pin arrangement 2 |

SI Unit COM.

| | |
|------------|-----------------|
| Nil | Positive common |
| N | Negative common |

Note) Without SI Unit, the symbol is nil.

Note) Without SI Unit, the symbol is nil.

● I/O unit sta. number

| | |
|------------|--------|
| Nil | None |
| 1 | 1 sta. |
| : | : |
| 9 | 9 sta. |

Note 1) Without SI Unit, the symbol is nil.
Note 2) SI Unit is not included in I/O unit station number.
Note 3) When I/O unit is selected, it is shipped separately, and assembled by customer. Refer to the attached operation manual for mounting method.

● Valve stations

| Symbol | Stations | Note |
|-----------|----------|--------------------------------------|
| 02 | 2 sta. | Double wiring specification (Note 1) |
| : | : | |
| 16 | 16 sta. | Specified layout (Note 2) |
| 02 | 2 sta. | |
| : | : | (Up to 32 solenoids possible) |
| 20 | 20 sta. | |

Note 1) Double wiring specifications: Single, double, 3 position and 4 position solenoid valves can be used at all of the manifold stations. When single solenoid is used, control signal which is not assigned to any number is ignored. If empty signal is not wanted, please order with signal layout specified.
Note 2) Specified layout: Indicate wiring specifications with the manifold specification sheet. (Note that double, 3 position and 4 position valves cannot be used where single solenoid wiring has been specified.)

● A, B port size (Metric)

| Symbol | A, B port | P, E port | Applicable series |
|------------|------------------------|-----------------------|-------------------|
| C3 | ø3.2 One-touch fitting | ø8 One-touch fitting | SV1000 |
| C4 | ø4 One-touch fitting | | |
| C6 | ø6 One-touch fitting | | |
| C4 | ø4 One-touch fitting | ø10 One-touch fitting | SV2000 |
| C6 | ø6 One-touch fitting | | |
| C8 | ø8 One-touch fitting | | |
| C8 | ø8 One-touch fitting | ø12 One-touch fitting | SV3000 |
| C6 | ø6 One-touch fitting | | |
| C8 | ø8 One-touch fitting | | |
| C10 | ø10 One-touch fitting | | |
| M | A, B port mixed | | |

● A, B port size (Inch)

| Symbol | A, B port | P, E port | Applicable series |
|------------|--------------------------|--------------------------|-------------------|
| N1 | ø1/8" One-touch fitting | ø5/16" One-touch fitting | SV1000 |
| N3 | ø5/32" One-touch fitting | | |
| N7 | ø1/4" One-touch fitting | | |
| N3 | ø5/32" One-touch fitting | ø3/8" One-touch fitting | SV2000 |
| N7 | ø1/4" One-touch fitting | | |
| N9 | ø5/16" One-touch fitting | | |
| N7 | ø1/4" One-touch fitting | ø3/8" One-touch fitting | SV3000 |
| N9 | ø5/16" One-touch fitting | | |
| N11 | ø3/8" One-touch fitting | | |
| M | A, B port mixed | | |

* In the case of Mixed specifications (M), indicate separately with the manifold specification sheet.
* Regarding the X and PE port size of External pilot type (R), and X port size of External pilot/Built-in silencer type (RS), ø4 (mm) and ø5/32" (inch) for the SV1000/2000 series, ø6 (mm) and, ø1/4" (inch) for the SV3000 series.

How to Order Manifold Assembly (Example)

Example (SS5V1)

Manifold
Power supply with
M12 connector

For the I/O unit part number mounted, refer to the **Web Catalog**.

- Digital Input Unit
- Digital Output Unit
- Digital Input/Output Unit
- Analog Input Unit
- Analog Output Unit
- Analog Input/Output Unit

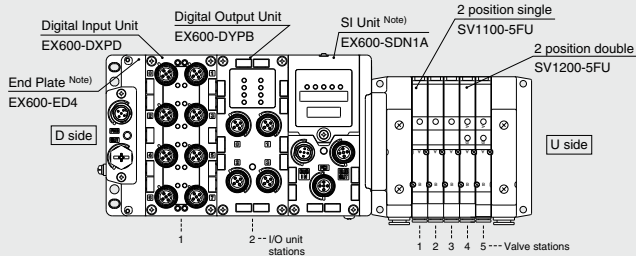

Serial transmission kit

- SS5V1-W10S6Q4N2D-05B-C6 1 set **Manifold base part number**
- * SV1100-5FU 3 sets **Valve part number (Stations 1 to 3)**
- * SV1200-5FU 2 sets **Valve part number (Stations 4 to 5)**
- * EX600-DXPD 1 set **I/O unit part number (Station 1)**
- * EX600-DYPB 1 set **I/O unit part number (Station 2)**

Enter in order starting from the first station on the D side.
When entry of part numbers becomes complicated, indicate with the manifold specification sheet.

Enter in order starting from the first station on the D side.
When entry of part numbers becomes complicated, indicate with the manifold specification sheet.

→ The asterisk denotes the symbol for assembly.
Prefix it to the part nos. of the solenoid valve, etc.

(Note) Do not enter the SI Unit part number and the End Plate part number together.

How to Order Valves

SV **1** **1** 00 **5** FU **U** **5**

Series

| | |
|---|--------|
| 1 | SV1000 |
| 2 | SV2000 |
| 3 | SV3000 |

Type of actuation

| | |
|---|---|
| 1 | 2 position single solenoid |
| 2 | 2 position double solenoid |
| 3 | 3 position closed center |
| 4 | 3 position exhaust center |
| 5 | 3 position pressure center |
| A | 4 position dual 3 port valve: N.C./N.C. |
| B | 4 position dual 3 port valve: N.O./N.O. |
| C | 4 position dual 3 port valve: N.C./N.O. |

* 4 position dual 3 port valves are applicable to the SV1000/2000 series only.

Pilot specifications

| | |
|-----|----------------|
| NII | Internal pilot |
| R | External pilot |

* External pilot specification is not available for 4 position dual 3 port valves.

Back pressure check valve

| | |
|-----|----------|
| NII | None |
| K | Built-in |

* Built-in back pressure check valve type is applicable to the SV1000 series only.
* The 3 position valve is not available with the back pressure check valve.

Made to Order

| | |
|-----|----------------------------|
| NII | — |
| X90 | Fluororubber specification |

Manual override

NII: Non-locking push type D: Push-turn locking slotted type

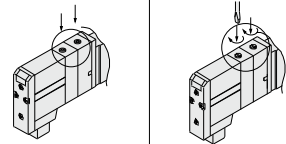

Light/Surge voltage suppressor

| | |
|---|-------------------------------------|
| U | With light/surge voltage suppressor |
| R | With surge voltage suppressor |

Coil voltage

| | |
|---|--------|
| 5 | 24 VDC |
|---|--------|

Dimensions: SV1000 Series

Power supply with M12 connector

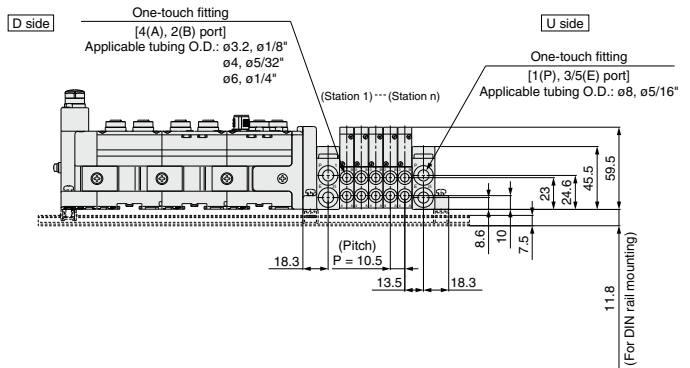
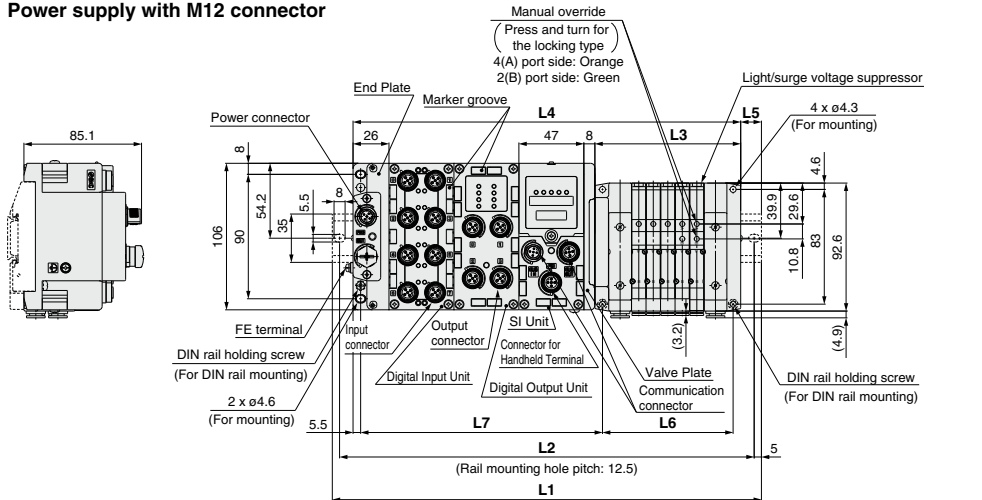

| |
|------------------------|
| L2 = L1 - 10.5 |
| L3 = 10.5 x n1 + 53 |
| L4 = L3 + 81 + 47 x n2 |
| L5 = (L1 - L4)/2 |
| L6 = 10.5 x n1 + 42 |
| L7 = 47 x n2 + 81 |

L1: DIN Rail Overall Length

| I/O unit stations (n2) \ Valve stations (n1) | 2 | 3 | 4 | 5 | 6 | 7 | 8 | 9 | 10 | 11 | 12 | 13 | 14 | 15 | 16 | 17 | 18 | 19 | 20 |
|--|-------|-------|-------|-------|-------|-------|-------|-------|-------|-------|-------|-------|-------|-------|-------|-------|-------|-------|-------|
| 0 | 185.5 | 198 | 210.5 | 210.5 | 223 | 235.5 | 248 | 260.5 | 273 | 273 | 285.5 | 298 | 310.5 | 323 | 335.5 | 348 | 348 | 360.5 | 373 |
| 1 | 235.5 | 248 | 248 | 260.5 | 273 | 285.5 | 298 | 310.5 | 310.5 | 323 | 335.5 | 348 | 360.5 | 373 | 373 | 385.5 | 398 | 410.5 | 423 |
| 2 | 273 | 285.5 | 298 | 310.5 | 323 | 335.5 | 335.5 | 348 | 360.5 | 373 | 385.5 | 398 | 410.5 | 410.5 | 423 | 435.5 | 448 | 460.5 | 473 |
| 3 | 323 | 335.5 | 348 | 360.5 | 373 | 373 | 385.5 | 398 | 410.5 | 423 | 435.5 | 448 | 460.5 | 473 | 473 | 485.5 | 498 | 498 | 510.5 |
| 4 | 373 | 385.5 | 398 | 398 | 410.5 | 423 | 435.5 | 448 | 460.5 | 473 | 473 | 485.5 | 498 | 510.5 | 523 | 535.5 | 548 | 548 | 560.5 |
| 5 | 423 | 435.5 | 435.5 | 448 | 460.5 | 473 | 485.5 | 498 | 498 | 510.5 | 523 | 535.5 | 548 | 560.5 | 560.5 | 573 | 585.5 | 598 | 610.5 |
| 6 | 460.5 | 473 | 485.5 | 498 | 510.5 | 523 | 535.5 | 535.5 | 548 | 560.5 | 573 | 585.5 | 598 | 598 | 610.5 | 623 | 635.5 | 648 | 660.5 |
| 7 | 510.5 | 523 | 535.5 | 548 | 560.5 | 560.5 | 573 | 585.5 | 598 | 610.5 | 623 | 623 | 635.5 | 648 | 660.5 | 673 | 685.5 | 698 | 698 |
| 8 | 560.5 | 573 | 585.5 | 598 | 598 | 610.5 | 623 | 635.5 | 648 | 660.5 | 660.5 | 673 | 685.5 | 698 | 710.5 | 723 | 723 | 735.5 | 748 |
| 9 | 610.5 | 623 | 623 | 635.5 | 648 | 660.5 | 673 | 685.5 | 685.5 | 698 | 710.5 | 723 | 735.5 | 748 | 760.5 | 760.5 | 773 | 785.5 | 798 |

Dimensions: SV1000 Series

Power supply with 7/8 inch connector

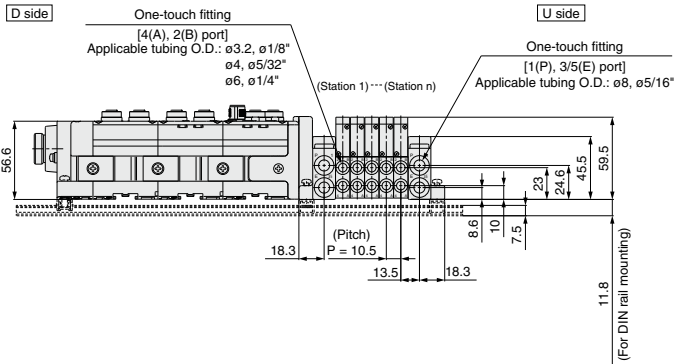
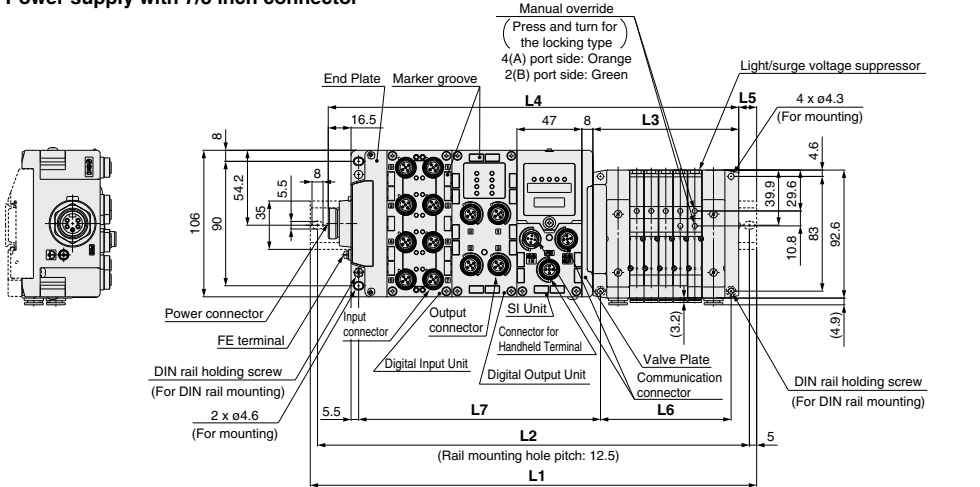

$L2 = L1 - 10.5$
 $L3 = 10.5 \times n1 + 53$
 $L4 = L3 + 97.5 + 47 \times n2$
 $L5 = (L1 - L4) / 2$
 $L6 = 10.5 \times n1 + 42$
 $L7 = 47 \times n2 + 81$

L1: DIN Rail Overall Length

| I/O unit stations (n2) \ Valve stations (n1) | 2 | 3 | 4 | 5 | 6 | 7 | 8 | 9 | 10 | 11 | 12 | 13 | 14 | 15 | 16 | 17 | 18 | 19 | 20 |
|--|-------|-------|-------|-------|-------|-------|-------|-------|-------|-------|-------|-------|-------|-------|-------|-------|-------|-------|-------|
| 0 | 198 | 210.5 | 223 | 235.5 | 248 | 248 | 260.5 | 273 | 285.5 | 298 | 310.5 | 310.5 | 323 | 335.5 | 348 | 360.5 | 373 | 385.5 | 385.5 |
| 1 | 248 | 260.5 | 273 | 285.5 | 285.5 | 298 | 310.5 | 323 | 335.5 | 348 | 360.5 | 373 | 385.5 | 398 | 410.5 | 410.5 | 423 | 435.5 | 435.5 |
| 2 | 298 | 310.5 | 310.5 | 323 | 335.5 | 348 | 360.5 | 373 | 373 | 385.5 | 398 | 410.5 | 423 | 435.5 | 448 | 448 | 460.5 | 473 | 485.5 |
| 3 | 348 | 348 | 360.5 | 373 | 385.5 | 398 | 410.5 | 410.5 | 423 | 435.5 | 448 | 460.5 | 473 | 473 | 485.5 | 498 | 510.5 | 523 | 535.5 |
| 4 | 385.5 | 398 | 410.5 | 423 | 435.5 | 435.5 | 448 | 460.5 | 473 | 485.5 | 498 | 510.5 | 510.5 | 523 | 535.5 | 548 | 560.5 | 573 | 573 |
| 5 | 435.5 | 448 | 460.5 | 473 | 473 | 485.5 | 498 | 510.5 | 523 | 535.5 | 535.5 | 548 | 560.5 | 573 | 585.5 | 598 | 598 | 610.5 | 623 |
| 6 | 485.5 | 498 | 498 | 510.5 | 523 | 535.5 | 548 | 560.5 | 573 | 573 | 585.5 | 598 | 610.5 | 623 | 635.5 | 635.5 | 648 | 660.5 | 673 |
| 7 | 535.5 | 535.5 | 548 | 560.5 | 573 | 585.5 | 598 | 598 | 610.5 | 623 | 635.5 | 648 | 660.5 | 660.5 | 673 | 685.5 | 698 | 710.5 | 723 |
| 8 | 573 | 585.5 | 598 | 610.5 | 623 | 635.5 | 635.5 | 648 | 660.5 | 673 | 685.5 | 698 | 698 | 710.5 | 723 | 735.5 | 748 | 760.5 | 760.5 |
| 9 | 623 | 635.5 | 648 | 660.5 | 660.5 | 673 | 685.5 | 698 | 710.5 | 723 | 723 | 735.5 | 748 | 760.5 | 773 | 785.5 | 798 | 798 | 810.5 |

Dimensions: SV2000 Series

Power supply with 7/8 inch connector

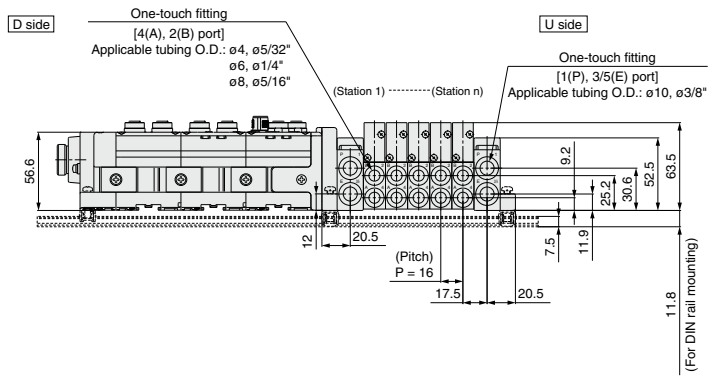
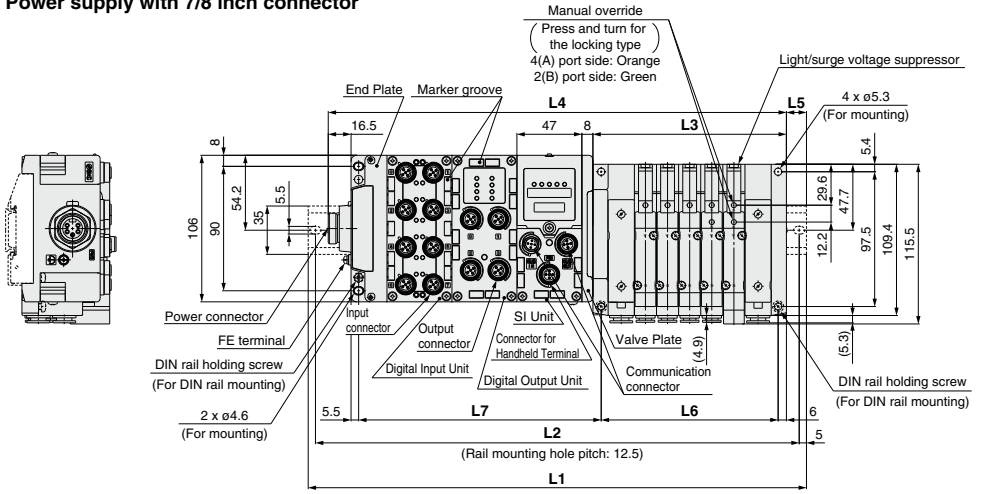

- L2 = L1 - 10.5
- L3 = 16 x n1 + 60
- L4 = L3 + 97.5 + 47 x n2
- L5 = (L1 - L4)/2
- L6 = 16 x n1 + 48
- L7 = 47 x n2 + 81.5

L1: DIN Rail Overall Length

| I/O unit stations (n2) \ Valve stations (n1) | 2 | 3 | 4 | 5 | 6 | 7 | 8 | 9 | 10 | 11 | 12 | 13 | 14 | 15 | 16 | 17 | 18 | 19 | 20 |
|--|-------|-------|-------|-------|-------|-------|-------|-------|-------|-------|-------|-------|-------|-------|-------|-------|-------|-------|-------|
| 0 | 223 | 235.5 | 248 | 273 | 285.5 | 298 | 310.5 | 335.5 | 348 | 360.5 | 373 | 398 | 410.5 | 423 | 448 | 460.5 | 473 | 485.5 | 510.5 |
| 1 | 260.5 | 285.5 | 298 | 310.5 | 335.5 | 348 | 360.5 | 373 | 398 | 410.5 | 423 | 448 | 460.5 | 473 | 485.5 | 510.5 | 523 | 535.5 | 548 |
| 2 | 310.5 | 323 | 348 | 360.5 | 373 | 398 | 410.5 | 423 | 435.5 | 460.5 | 473 | 485.5 | 510.5 | 523 | 535.5 | 548 | 573 | 585.5 | 598 |
| 3 | 360.5 | 373 | 398 | 410.5 | 423 | 435.5 | 460.5 | 473 | 485.5 | 498 | 523 | 535.5 | 548 | 573 | 585.5 | 598 | 610.5 | 635.5 | 648 |
| 4 | 410.5 | 423 | 435.5 | 460.5 | 473 | 485.5 | 498 | 523 | 535.5 | 548 | 573 | 585.5 | 598 | 610.5 | 635.5 | 648 | 660.5 | 673 | 698 |
| 5 | 448 | 473 | 485.5 | 498 | 523 | 535.5 | 548 | 560.5 | 585.5 | 598 | 610.5 | 635.5 | 648 | 660.5 | 673 | 698 | 710.5 | 723 | 748 |
| 6 | 498 | 523 | 535.5 | 548 | 560.5 | 585.5 | 598 | 610.5 | 623 | 648 | 660.5 | 673 | 698 | 710.5 | 723 | 735.5 | 760.5 | 773 | 785.5 |
| 7 | 548 | 560.5 | 585.5 | 598 | 610.5 | 623 | 648 | 660.5 | 673 | 698 | 710.5 | 723 | 735.5 | 760.5 | 773 | 785.5 | 798 | 823 | 835.5 |
| 8 | 598 | 610.5 | 623 | 648 | 660.5 | 673 | 685.5 | 710.5 | 723 | 735.5 | 760.5 | 773 | 785.5 | 798 | 823 | 835.5 | 848 | 873 | 885.5 |
| 9 | 648 | 660.5 | 673 | 685.5 | 710.5 | 723 | 735.5 | 748 | 773 | 785.5 | 798 | 823 | 835.5 | 848 | 860.5 | 885.5 | 898 | 910.5 | 935.5 |

Dimensions: SV3000 Series

Power supply with 7/8 inch connector

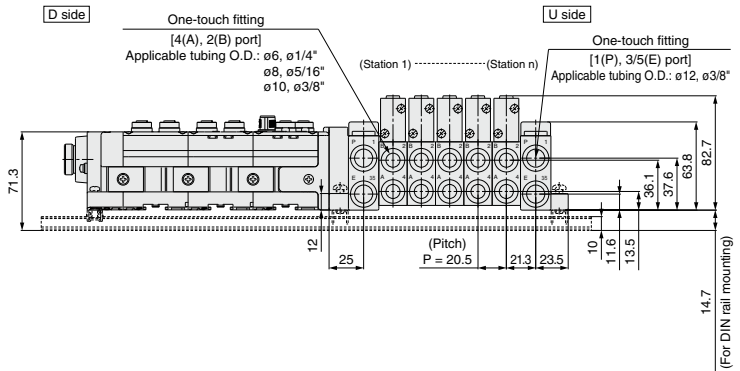
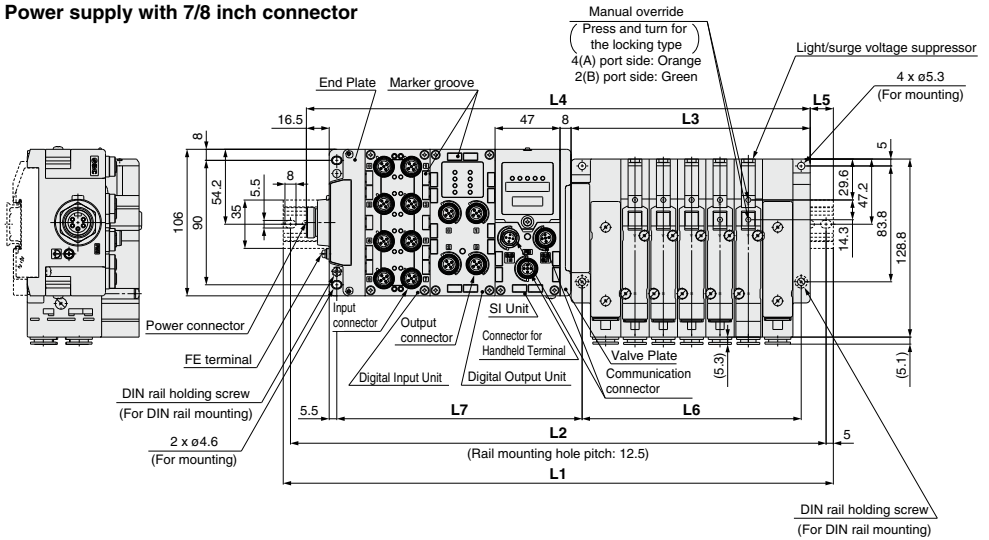

- L2 = L1 - 10.5
- L3 = 20.5 x n1 + 70.5
- L4 = L3 + 97.5 + 47 x n2
- L5 = (L1 - L4)/2
- L6 = 20.5 x n1 + 56
- L7 = 47 x n2 + 83.5

L1: DIN Rail Overall Length

| I/O unit stations (n2) \ Valve stations (n1) | 2 | 3 | 4 | 5 | 6 | 7 | 8 | 9 | 10 | 11 | 12 | 13 | 14 | 15 | 16 | 17 | 18 | 19 | 20 |
|--|-------|-------|-------|-------|-------|-------|-------|-------|-------|-------|-------|-------|-------|-------|-------|-------|-------|-------|-------|
| 0 | 235.5 | 260.5 | 285.5 | 298 | 323 | 335.5 | 360.5 | 385.5 | 398 | 423 | 448 | 460.5 | 485.5 | 510.5 | 523 | 548 | 560.5 | 585.5 | 610.5 |
| 1 | 285.5 | 310.5 | 323 | 348 | 373 | 385.5 | 410.5 | 423 | 448 | 473 | 485.5 | 510.5 | 535.5 | 548 | 573 | 598 | 610.5 | 635.5 | 660.5 |
| 2 | 335.5 | 348 | 373 | 398 | 410.5 | 435.5 | 460.5 | 473 | 498 | 523 | 535.5 | 560.5 | 573 | 598 | 623 | 635.5 | 660.5 | 685.5 | 698 |
| 3 | 385.5 | 398 | 423 | 435.5 | 460.5 | 485.5 | 498 | 523 | 548 | 560.5 | 585.5 | 610.5 | 623 | 648 | 660.5 | 685.5 | 710.5 | 723 | 748 |
| 4 | 423 | 448 | 473 | 485.5 | 510.5 | 523 | 548 | 573 | 585.5 | 610.5 | 635.5 | 648 | 673 | 698 | 710.5 | 735.5 | 760.5 | 773 | 798 |
| 5 | 473 | 498 | 510.5 | 535.5 | 560.5 | 573 | 598 | 623 | 635.5 | 660.5 | 673 | 698 | 723 | 735.5 | 760.5 | 785.5 | 798 | 823 | 848 |
| 6 | 523 | 535.5 | 560.5 | 585.5 | 598 | 623 | 648 | 660.5 | 685.5 | 710.5 | 723 | 748 | 760.5 | 785.5 | 810.5 | 823 | 848 | 873 | 885.5 |
| 7 | 573 | 585.5 | 610.5 | 623 | 648 | 673 | 685.5 | 710.5 | 735.5 | 748 | 773 | 798 | 810.5 | 835.5 | 860.5 | 873 | 898 | 910.5 | 935.5 |
| 8 | 610.5 | 635.5 | 660.5 | 673 | 698 | 723 | 735.5 | 760.5 | 773 | 798 | 823 | 835.5 | 860.5 | 885.5 | 898 | 923 | 948 | 960.5 | 985.5 |
| 9 | 660.5 | 685.5 | 698 | 723 | 748 | 760.5 | 785.5 | 810.5 | 823 | 848 | 860.5 | 885.5 | 910.5 | 923 | 948 | 973 | 985.5 | — | — |

Integrated-type (For Output) Serial Transmission System

EX260 Series

IP67 (partly IP40) compliant

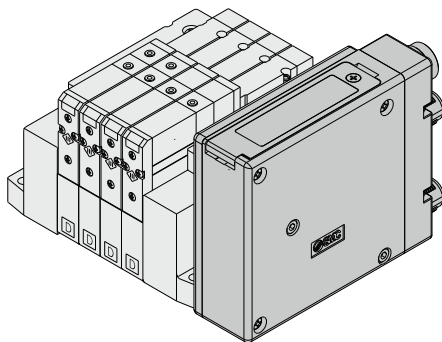

Tie-rod base

| | |
|-------------------|---|
| Applicable series | Tie-rod base manifold SV1000/SV2000/SV3000 |
|-------------------|---|

| |
|--|
| • Number of outputs points: 16, 32 points each |
|--|

Tie-rod Base: EX260 Integrated-type (For Output) Serial Transmission System

SV Series





How to Order Manifold

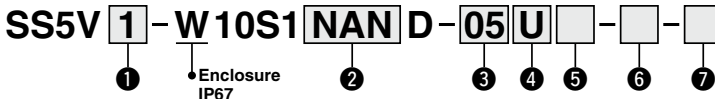

① Series

| | |
|---|--------|
| 1 | SV1000 |
| 2 | SV2000 |
| 3 | SV3000 |

② SI Unit specifications

(output polarity, protocol, number of outputs, communication connector)

| Symbol (output polarity) | Protocol | Number of outputs | Communication connector |
|--------------------------|-----------------------|-------------------|-------------------------|
| Positive common (NPN) | Negative common (NPN) | | |
| 0 Without SI Unit | | | |
| QA | QAN | 32 | M12 |
| QB | QBN | 16 | |
| NA | NAN | 32 | |
| NB | NBN | 16 | M12 |
| NC | NCN | 32 | |
| ND | NDN | 16 | |
| VA | VAN | 32 | M12 |
| VB | VBN | 16 | |
| DA | DAN | 32 | |
| DB | DBN | 16 | M12 |
| FA | FAN | 32 | |
| FB | FBN | 16 | |
| EA | EAN | 32 | M12 |
| EB | EBN | 16 | |
| GA | GAN | 32 | |
| GB | GBN | 16 | |
| — (Note 2) | | Ethernet | 32 |
| — (Note 2) | | POWERLINK | 16 |

Note 1) DIN rail cannot be mounted without SI Unit.
 Note 2) Positive common (NPN) type is not applicable.
 Note 3) IP40 for the D-sub applicable communication connector specification.
 (The manifold part number is "SS5V□-10S1NC/ND□.")
 Note 4) For SI unit part number, refer to the table below.

③ Valve stations

In case of the 32 Outputs SI unit

| Symbol | Stations | Note |
|--------|-------------|---|
| 02 | 2 stations | Double wiring (Note 1) |
| ⋮ | ⋮ | |
| 16 | 16 stations | |
| 02 | 2 stations | Specified layout (Note 2) (Available up to 32 solenoids) |
| ⋮ | ⋮ | |
| 20 | 20 stations | |

In case of the 16 Outputs SI unit

| Symbol | Stations | Note |
|--------|-------------|---|
| 02 | 2 stations | Double wiring (Note 1) |
| ⋮ | ⋮ | |
| 08 | 8 stations | |
| 02 | 2 stations | Specified layout (Note 2) (Available up to 16 solenoids) |
| ⋮ | ⋮ | |
| 16 | 16 stations | |

Note 1) Double wiring: single, double, 3-position and 4-position solenoid valves can be used on all manifold stations.
 Use of a single solenoid will result in an unused control signal. If this is not desired, order with a specified layout.
 Note 2) Specified layout: Indicate the wiring specifications with the manifold specification sheet.
 (Note that double, 3-position and 4-position valves cannot be used where single solenoid wiring has been specified.)

④ P, E port location

| | |
|---|-------------------------------|
| U | U side (2 to 10 stations) |
| D | D side (2 to 10 stations) |
| B | Both sides (2 to 20 stations) |

⑤ SUP/EXH block assembly specifications

| | |
|-----------|----------------------------------|
| NII | Internal pilot |
| S (Note) | Internal pilot/Built-in silencer |
| R | External pilot |
| RS (Note) | External pilot/Built-in silencer |

Note) When the built-in silencer type is used, keep the air outlet from coming in direct contact with water or other liquids.

⑦ Mounting

| | |
|-----|--------------------------------------|
| NII | Direct mounting |
| D | DIN rail mounting (With DIN rail) |
| D0 | DIN rail mounting (Without DIN rail) |
| D3 | For 3 stations |
| ⋮ | ⋮ |
| D20 | For 20 stations |

When a longer DIN rail is desired than the specified stations. (Specify a longer rail than the standard length.)

* If the DIN rail must be mounted without an SI Unit, select "D0" and order the DIN rail separately. Refer to L3 of the dimensions for the DIN rail length. For the DIN rail part number, refer to page 123.

⑥ A, B port size (Metric size)

| Symbol | A, B port | P, E port | Applicable series |
|--------|------------------------|-----------|-------------------|
| C3 | ø3.2 One-touch fitting | ø8 | SV1000 |
| C4 | ø4 One-touch fitting | | |
| C6 | ø6 One-touch fitting | | |
| C4 | ø4 One-touch fitting | ø10 | SV2000 |
| C6 | ø6 One-touch fitting | | |
| C8 | ø8 One-touch fitting | | |
| C6 | ø6 One-touch fitting | ø12 | SV3000 |
| C8 | ø8 One-touch fitting | | |
| C10 | ø10 One-touch fitting | | |
| M | A, B ports mixed | | |

* In the case of mixed specifications (M), indicate separately on the manifold specification sheet.

* The port sizes of X, PE ports for external pilot specifications (R, RS) are ø4 (millimeters) or ø5/32" (inches) for the SV1000/2000 series, and ø6 (millimeters) or ø1/4" (inches) for the SV3000 series.

EX260 SI unit part no.

| Symbol | Protocol | Number of outputs | Communication connector | SI unit part no. | |
|--------|------------|-------------------|-------------------------|------------------|------------|
| | | | | +COM. | -COM. |
| QA | DeviceNet® | 32 | M12 | EX260-SDN2 | EX260-SDN1 |
| QB | | 16 | | EX260-SDN4 | EX260-SDN3 |
| NA | PROFIBUS | 32 | M12 | EX260-SPR2 | EX260-SPR1 |
| NB | | 16 | | EX260-SPR4 | EX260-SPR3 |
| NC | | 32 | | EX260-SPR6 | EX260-SPR5 |
| ND | D-sub | 16 | D-sub | EX260-SPR8 | EX260-SPR7 |
| VA | | 32 | | EX260-SMJ2 | EX260-SMJ1 |
| VB | CC-Link | 16 | M12 | EX260-SMJ4 | EX260-SMJ3 |

A, B port size (Inch size)

| Symbol | A, B port | P, E port | Applicable series |
|--------|--------------------------|-----------|-------------------|
| N1 | ø1/8" One-touch fitting | ø5/16" | SV1000 |
| N3 | ø5/32" One-touch fitting | | |
| N7 | ø1/4" One-touch fitting | | |
| N3 | ø5/32" One-touch fitting | ø3/8" | SV2000 |
| N7 | ø1/4" One-touch fitting | | |
| N9 | ø5/16" One-touch fitting | | |
| N7 | ø1/4" One-touch fitting | ø3/8" | SV3000 |
| N9 | ø5/16" One-touch fitting | | |
| N11 | ø3/8" One-touch fitting | | |
| M | A, B ports mixed | | |

EX260 SI unit part no.

| Symbol | Protocol | Number of outputs | Communication connector | SI unit part no. | |
|--------|--------------|-------------------|-------------------------|------------------|------------|
| | | | | +COM. | -COM. |
| DA | EtherCAT | 32 | M12 | EX260-SEC2 | EX260-SEC1 |
| DB | | 16 | | EX260-SEC4 | EX260-SEC3 |
| FA | PROFINET | 32 | M12 | EX260-SPN2 | EX260-SPN1 |
| FB | | 16 | | EX260-SPN4 | EX260-SPN3 |
| EA | | 32 | | EX260-SEN2 | EX260-SEN1 |
| EB | EtherNet/IP™ | 16 | M12 | EX260-SEN4 | EX260-SEN3 |
| GA | Ethernet | 32 | | — | EX260-SPL1 |
| GB | POWERLINK | 16 | | — | EX260-SPL3 |

How to Order Manifold Assembly

Example (SV1000)

Manifold

SS5V1-W10S1NAND-04B-C6 (1 set)

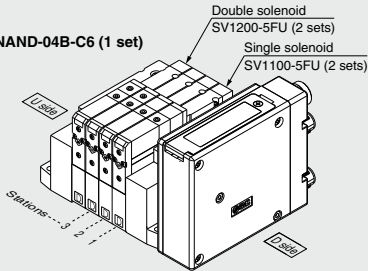

SS5V1-W10S1NAND-04B-C6 1 set (Manifold part no.)
 *SV1100-5FU 2 sets (Single solenoid part no.)
 *SV1200-5FU 2 sets (Double solenoid part no.)

How to Order Valves

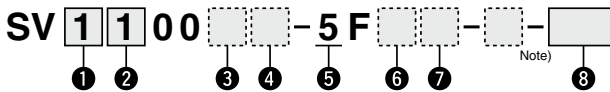

1 Series

| | |
|---|--------|
| 1 | SV1000 |
| 2 | SV2000 |
| 3 | SV3000 |

2 Type of actuation

| | |
|---|---|
| 1 | 2-position single |
| 2 | 2-position double |
| 3 | 3-position closed center |
| 4 | 3-position exhaust center |
| 5 | 3-position pressure center |
| A | 4-position dual 3-port valve: N.C./N.C. |
| B | 4-position dual 3-port valve: N.O./N.O. |
| C | 4-position dual 3-port valve: N.C./N.O. |

* 4-position dual 3-port valves are applicable to the SV1000 and SV2000 series only.

3 Pilot type

| | |
|-----|----------------|
| NII | Internal pilot |
| R | External pilot |

* External pilot specifications is not available for 4-position dual 3-port valves.

4 Back pressure check valve

| | |
|-----|----------|
| NII | None |
| K | Built-in |

* Built-in back pressure check valve type is applicable to the SV1000 series only.
 * Back pressure check valve is not available for 3-position valve.

Note) Refer to Specific Product Precautions 2 on page 136.

5 Rated voltage

| | |
|---|--------|
| 5 | 24 VDC |
|---|--------|

6 Light/Surge voltage suppressor

| | |
|---|-------------------------------------|
| U | With light/surge voltage suppressor |
| R | With surge voltage suppressor |

7 Manual override

NII: Non-locking push type

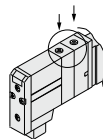

D: Push-turn locking slotted type

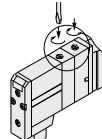

Note) Available with manifold block for station additions. Refer to page 119.

8 Made to Order

| | |
|-----|--|
| NII | — |
| X90 | Main valve fluororubber (Refer to page 134.) |

- Refer to the **Web Catalog** for the dimensions of single SI unit.
- Refer to the technical operation manual for details of SI unit.

Dimensions: SV1000 Series for EX260 Integrated-type (For Output) Serial Transmission System

● Tie-rod base manifold: SS5V1-W10S1□□D-Stations $\frac{U}{D}$ (S, R, RS)- $\frac{C3, N1}{C4, N3}$ (-D)

- When P, E port outlets are indicated on the U side or D side, the P, E ports on the opposite side are plugged.
- External pilot port positions and silencer discharge port positions are the same as P, E port outlet positions.

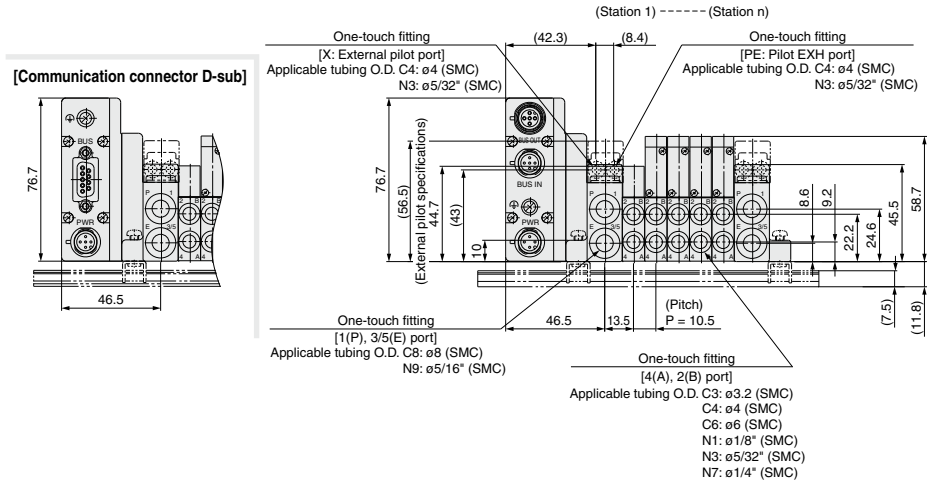
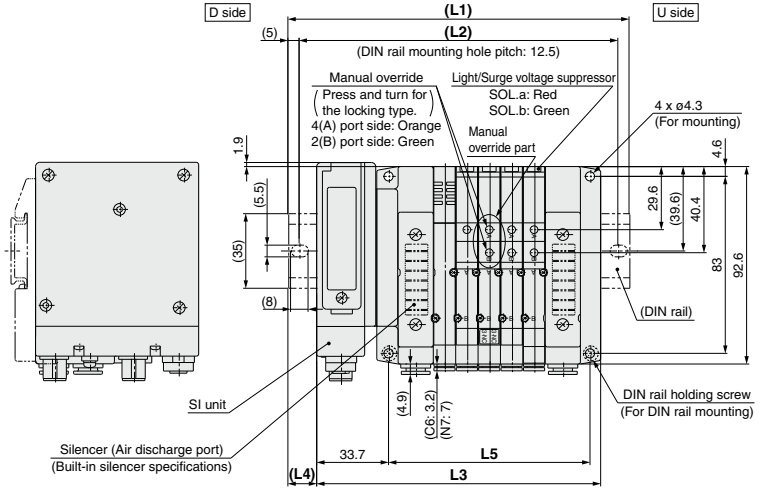

L: DIN Rail Overall Length

| L | n: Stations | | | | | | | | | | | | | | | | | | | |
|----|-------------|-------|-------|-------|-------|-------|-------|-------|-------|-------|-------|-------|-------|-------|-------|-------|-------|-------|-------|--|
| | 2 | 3 | 4 | 5 | 6 | 7 | 8 | 9 | 10 | 11 | 12 | 13 | 14 | 15 | 16 | 17 | 18 | 19 | 20 | |
| L1 | 135.5 | 148 | 148 | 160.5 | 173 | 185.5 | 198 | 210.5 | 210.5 | 223 | 235.5 | 248 | 260.5 | 273 | 273 | 285.5 | 298 | 310.5 | 323 | |
| L2 | 125 | 137.5 | 137.5 | 150 | 162.5 | 175 | 187.5 | 200 | 200 | 212.5 | 225 | 237.5 | 250 | 262.5 | 262.5 | 275 | 287.5 | 300 | 312.5 | |
| L3 | 102.2 | 112.7 | 123.2 | 133.7 | 144.2 | 154.7 | 165.2 | 175.7 | 186.2 | 196.7 | 207.2 | 217.7 | 228.2 | 238.7 | 249.2 | 259.7 | 270.2 | 280.7 | 291.2 | |
| L4 | 16.5 | 17.5 | 12.5 | 13.5 | 14.5 | 15.5 | 16.5 | 17.5 | 12 | 13 | 14 | 15 | 16 | 17 | 12 | 13 | 14 | 15 | 16 | |
| L5 | 63 | 73.5 | 84 | 94.5 | 105 | 115.5 | 126 | 136.5 | 147 | 157.5 | 168 | 178.5 | 189 | 199.5 | 210 | 220.5 | 231 | 241.5 | 252 | |

Dimensions: SV2000 Series for EX260 Integrated-type (For Output) Serial Transmission System

● Tie-rod base manifold: SS5V2-W10S1□□D-**Stations** $\frac{U}{D}$ (S, R, RS)- $\frac{C3, N3}{C6, N6}$ (-D)

- When P, E port outlets are indicated on the U side or D side, the P, E ports on the opposite side are plugged.
- External pilot port positions and silencer discharge port positions are the same as P, E port outlet positions.

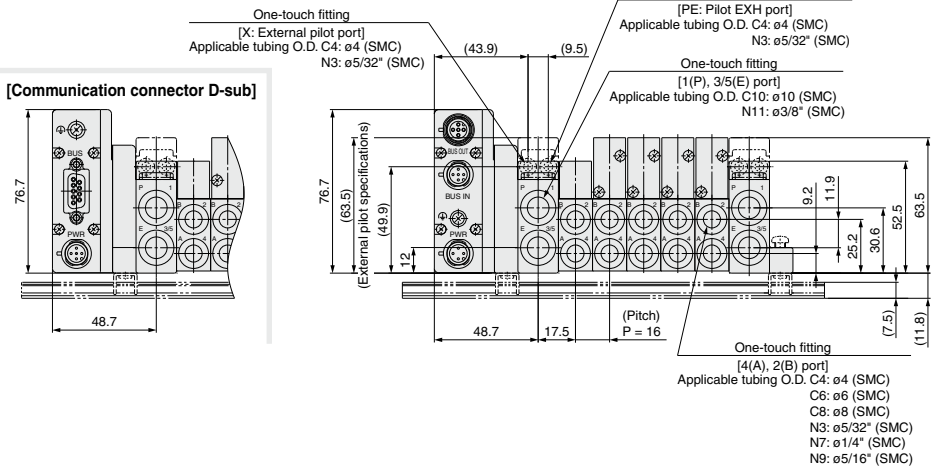
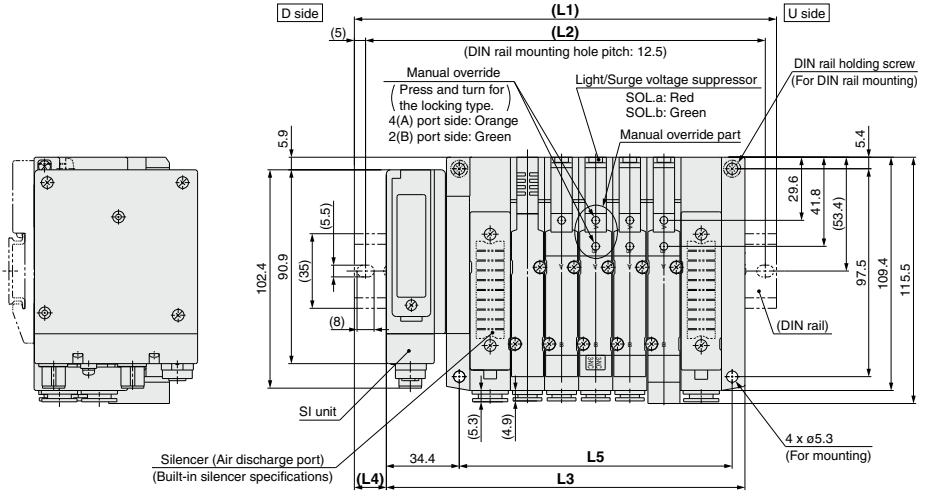

L: DIN Rail Overall Length

| L | n: Stations | | | | | | | | | | | | | | | | | | | |
|----|-------------|-------|-------|-------|-------|-------|-------|-------|-------|-------|-------|-------|-------|-------|-------|-------|-------|-------|-------|--|
| | 2 | 3 | 4 | 5 | 6 | 7 | 8 | 9 | 10 | 11 | 12 | 13 | 14 | 15 | 16 | 17 | 18 | 19 | 20 | |
| L1 | 148 | 160.5 | 185.5 | 198 | 210.5 | 235.5 | 248 | 260.5 | 273 | 298 | 310.5 | 323 | 335.5 | 360.5 | 373 | 385.5 | 410.5 | 423 | 435.5 | |
| L2 | 137.5 | 150 | 175 | 187.5 | 200 | 225 | 237.5 | 250 | 262.5 | 287.5 | 300 | 312.5 | 325 | 350 | 362.5 | 375 | 400 | 412.5 | 425 | |
| L3 | 120.2 | 136.2 | 152.2 | 168.2 | 184.2 | 200.2 | 216.2 | 232.2 | 248.2 | 264.2 | 280.2 | 296.2 | 312.2 | 328.2 | 344.2 | 360.2 | 376.2 | 392.2 | 408.2 | |
| L4 | 14 | 12 | 16.5 | 15 | 13 | 17.5 | 16 | 14 | 12.5 | 17 | 15 | 13.5 | 11.5 | 16 | 14.5 | 12.5 | 17 | 15.5 | 13.5 | |
| L5 | 80 | 96 | 112 | 128 | 144 | 160 | 176 | 192 | 208 | 224 | 240 | 256 | 272 | 288 | 304 | 320 | 336 | 352 | 368 | |

Integrated-type (For Output) Serial Transmission System

EX126 Series

IP67 compliant

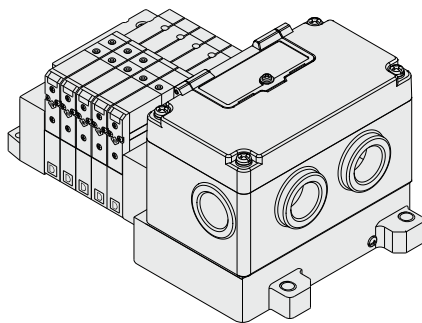

Applicable series **Tie-rod base manifold**
SV1000/SV2000/SV3000

• Number of outputs points: 16 points

EX126 Integrated-type (For Output) Serial Transmission System

SV Series



How to Order

• Tie-rod base

SS5V **1** - W 10S4 D-05 **U** - -

• Series

| | |
|---|--------|
| 1 | SV1000 |
| 2 | SV2000 |
| 3 | SV3000 |

• Enclosure IP67 specifications

• SI unit

| | |
|----|-------------------------------|
| 0 | Without SI unit and end plate |
| VW | CC-Link |

- When the SI unit is not included, only the terminal block plate is included.

• Mounting

| | |
|-----|---|
| Nil | Direct mounting |
| D | DIN rail mounting (With DIN rail) |
| D0* | DIN rail mounting (Without DIN rail) |
| D3 | For 3 stations When a longer DIN rail is desired than the specified stations. (Specify a longer rail than the standard length.) |
| : | : |
| : | : |
| D16 | For 16 stations |

- * In the case of D0, only DIN rail fittings are attached.

• Valve stations

| Symbol | Stations | Note |
|--------|-------------|--|
| 02 | 2 stations | Double wiring specifications (1) |
| : | : | |
| 08 | 8 stations | |
| 02 | 2 stations | Specified layout (2) (up to 16 solenoids possible.) |
| : | : | |
| 16 | 16 stations | |

Note 1) Double wiring specifications: Single, double, 3 position and 4 position solenoid valves can be used on all manifold stations. Use of a single solenoid will result in an unused control signal. If this is not desired, order with a specified layout.

Note 2) Specified layout: Indicate wiring specifications on a manifold specificationsheet. (Note that double, 3 and 4 position valves cannot be used where single solenoid wiring has been specified.)

• SUP/EXH block assembly specifications

| | |
|-----|----------------------------------|
| Nil | Internal pilot |
| S* | Internal pilot/Built-in silencer |
| R | External pilot |
| RS* | External pilot/Built-in silencer |

Note) When the built-in silencer type is used, keep the exhaust port from coming in direct contact with water or other liquids.

SI Unit Part No.

| Symbol | Protocol type | SI unit part no. |
|--------|---------------|------------------|
| VW | CC-Link | EX126D-SMJ1 |

Refer to the **Web Catalog** and the Operation Manual for the details of the EX126 Integrated-type (For Output) Serial Transmission System.
Please download the Operation Manual via our website, <https://www.smcworld.com>.

P, E port location

| | |
|---|-------------------------------|
| U | U side (2 to 10 stations) |
| D | D side (2 to 10 stations) |
| B | Both sides (2 to 16 stations) |

A, B port size (Metric)

| Symbol | A, B port | P, E port | Applicable series |
|--------|----------------------------|---------------------------|-------------------|
| C3 | One-touch fitting for ø3.2 | One-touch fitting for ø4 | SV1000 |
| C4 | One-touch fitting for ø4 | | |
| C6 | One-touch fitting for ø6 | | |
| C4 | One-touch fitting for ø4 | One-touch fitting for ø10 | SV2000 |
| C6 | One-touch fitting for ø6 | | |
| C8 | One-touch fitting for ø8 | | |
| C6 | One-touch fitting for ø6 | One-touch fitting for ø12 | SV3000 |
| C8 | One-touch fitting for ø8 | | |
| C10 | One-touch fitting for ø10 | | |
| M | A, B ports mixed | | |

A, B port size (Inch)

| Symbol | A, B port | P, E port | Applicable series |
|--------|------------------------------|------------------------------|-------------------|
| N1 | One-touch fitting for ø1/8" | One-touch fitting for ø5/16" | SV1000 |
| N3 | One-touch fitting for ø5/32" | | |
| N7 | One-touch fitting for ø1/4" | | |
| N3 | One-touch fitting for ø5/32" | One-touch fitting for ø3/8" | SV2000 |
| N7 | One-touch fitting for ø1/4" | | |
| N9 | One-touch fitting for ø5/16" | | |
| N7 | One-touch fitting for ø1/4" | One-touch fitting for ø3/8" | SV3000 |
| N9 | One-touch fitting for ø5/16" | | |
| N11 | One-touch fitting for ø3/8" | | |
| M | A, B ports mixed | | |

* In the case of mixed specifications (M), indicate separately on the manifold specification sheet.

* Port sizes of X, PE port for external pilot specification (R, RS) are ø4 (metric), ø5/32" (inch) for SV1000/2000 and ø6 (metric) and ø1/4" (inch) for SV3000.

How to Order Manifold Assembly

Ordering example (SV1000)

Manifold

SS5V1-W10S4VWD-05B-C6 (1 set)

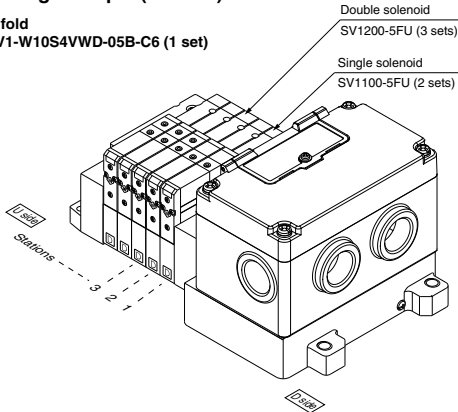

SS5V1-W10S4VWD-05B-C6 1 set (manifold part no.)
 * SV1100-5FU 2 sets (manifold part no.)
 * SV1200-5FU 3 sets (manifold part no.)

How to Order Valve

SV 1 1 0 0 - 5 F - - -

Series

| | |
|---|--------|
| 1 | SV1000 |
| 2 | SV2000 |
| 3 | SV3000 |

Type of actuation

| | |
|---|---|
| 1 | 2 position single |
| 2 | 2 position double |
| 3 | 3 position closed center |
| 4 | 3 position exhaust center |
| 5 | 3 position pressure center |
| A | 4 position dual 3 port valve: N.C./N.C. |
| B | 4 position dual 3 port valve: N.O./N.O. |
| C | 4 position dual 3 port valve: N.C./N.O. |

* 4 position dual 3 port valves are applicable to the SV1000 and SV2000 series only.

Pilot type

| | |
|-----|----------------|
| Nil | Internal pilot |
| R | External pilot |

* External pilot specifications is not available for 4 position dual 3 port valves.

Back pressure check valve

| | |
|-----|----------|
| Nil | None |
| K | Built-in |

* Built-in back pressure check valve type is applicable to the SV1000 series only.
 * Back pressure check valve is not available for 3 position valve.

Rated voltage

| | |
|---|--------|
| 5 | 24 VDC |
|---|--------|

Note) Available with manifold block for station additions. Refer to page 119.

Made to Order

| | |
|-----|--|
| Nil | - |
| X90 | Main valve fluororubber (Refer to page 134.) |

Manual override

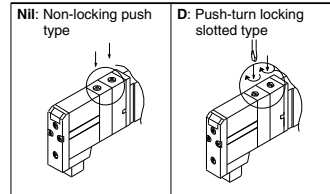

Light/Surge voltage suppressor

| | |
|---|-------------------------------------|
| U | With light/surge voltage suppressor |
| R | With surge voltage suppressor |

Note) Refer to Specific Product Precautions 2 on page 136.

Dimensions: SV1000 Series for EX126 Integrated-type (For Output) Serial Transmission System

● Tie-rod base manifold : SS5V1-W10S4 □ D-^UStations_B (S, R, RS)-^{C3, N1, C4, N3, C6, N7}(-D)

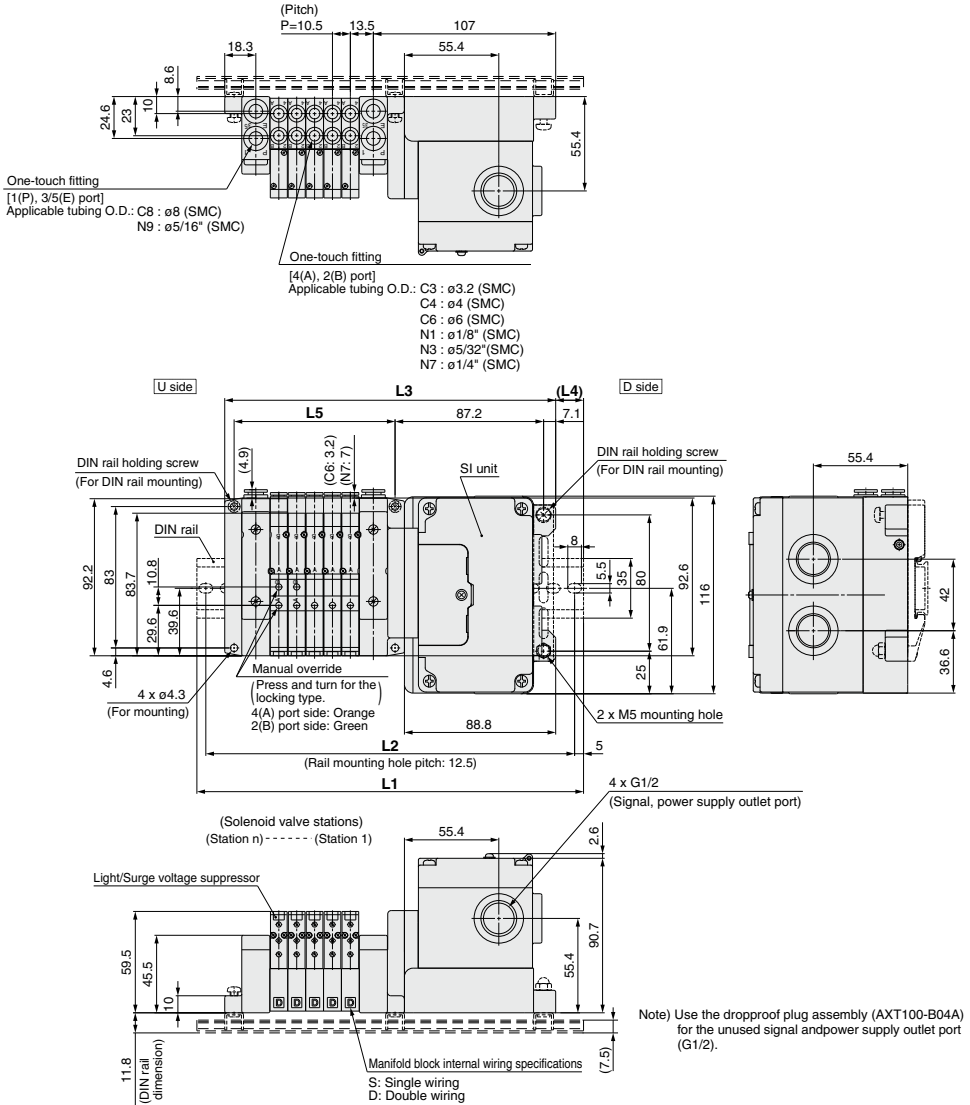

L Dimension

| n | 2 | 3 | 4 | 5 | 6 | 7 | 8 | 9 | 10 | 11 | 12 | 13 | 14 | 15 | 16 |
|----|-------|-------|-------|-------|-------|-------|-------|-------|-------|-------|-------|-------|-------|-------|-------|
| L1 | 198 | 198 | 210.5 | 223 | 235.5 | 248 | 260.5 | 260.5 | 273 | 285.5 | 298 | 310.5 | 323 | 323 | 335.5 |
| L2 | 187.5 | 187.5 | 200 | 212.5 | 225 | 237.5 | 250 | 250 | 262.5 | 275 | 287.5 | 300 | 312.5 | 312.5 | 325 |
| L3 | 162.8 | 173.3 | 183.8 | 194.3 | 204.8 | 215.3 | 225.8 | 236.3 | 246.8 | 257.3 | 267.8 | 278.3 | 288.8 | 299.3 | 309.8 |
| L4 | 17.5 | 12.5 | 13.5 | 14.5 | 15.5 | 16.5 | 17.5 | 12 | 13 | 14 | 15 | 16 | 17 | 12 | 13 |
| L5 | 63 | 73.5 | 84 | 94.5 | 105 | 115.5 | 126 | 136.5 | 147 | 157.5 | 168 | 178.5 | 189 | 199.5 | 210 |

Dimensions: SV2000 Series for EX126 Integrated-type (For Output) Serial Transmission System

● Tie-rod base manifold : SS5V2-W10S4 □ D- Stations $\frac{U}{D}$ (S, R, RS) $\frac{C4, N3}{C6, N7}$ $\frac{C8, N9}{C8, N9}$ (-D)

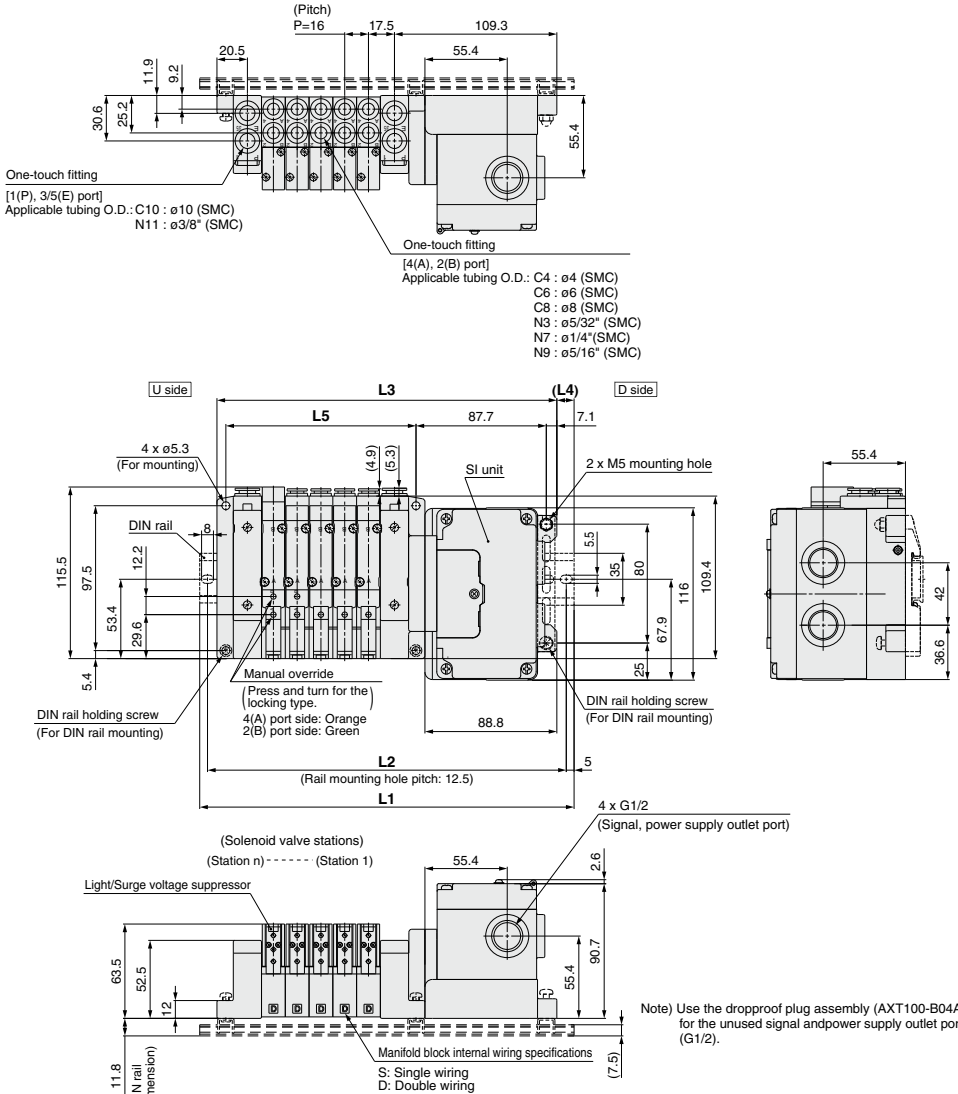

L Dimension

| n | 2 | 3 | 4 | 5 | 6 | 7 | 8 | 9 | 10 | 11 | 12 | 13 | 14 | 15 | 16 |
|----|-------|-------|-------|-------|-------|-------|-------|-------|-------|-------|-------|-------|-------|-------|-------|
| L1 | 210.5 | 223 | 248 | 260.5 | 273 | 285.5 | 310.5 | 323 | 335.5 | 348 | 373 | 385.5 | 398 | 423 | 435.5 |
| L2 | 200 | 212.5 | 237.5 | 250 | 262.5 | 275 | 300 | 312.5 | 325 | 337.5 | 362.5 | 375 | 387.5 | 412.5 | 425 |
| L3 | 180.8 | 196.8 | 212.8 | 228.8 | 244.8 | 260.8 | 276.8 | 292.8 | 308.8 | 324.8 | 340.8 | 356.8 | 372.8 | 388.8 | 404.8 |
| L4 | 15 | 13 | 17.5 | 16 | 14 | 12.5 | 17 | 15 | 13.5 | 11.5 | 16 | 14.5 | 12.5 | 17 | 15.5 |
| L5 | 80 | 96 | 112 | 128 | 144 | 160 | 176 | 192 | 208 | 224 | 240 | 256 | 272 | 288 | 304 |

n : Stations

Dimensions: SV3000 Series for EX126 Integrated-type (For Output) Serial Transmission System

● Tie-rod base manifold : SS5V3-W10S4 □ D-Stations $\frac{U}{D}$ (S, R, RS) $\frac{C6, N7}{C8, N6, C10, N11}$ (-D)

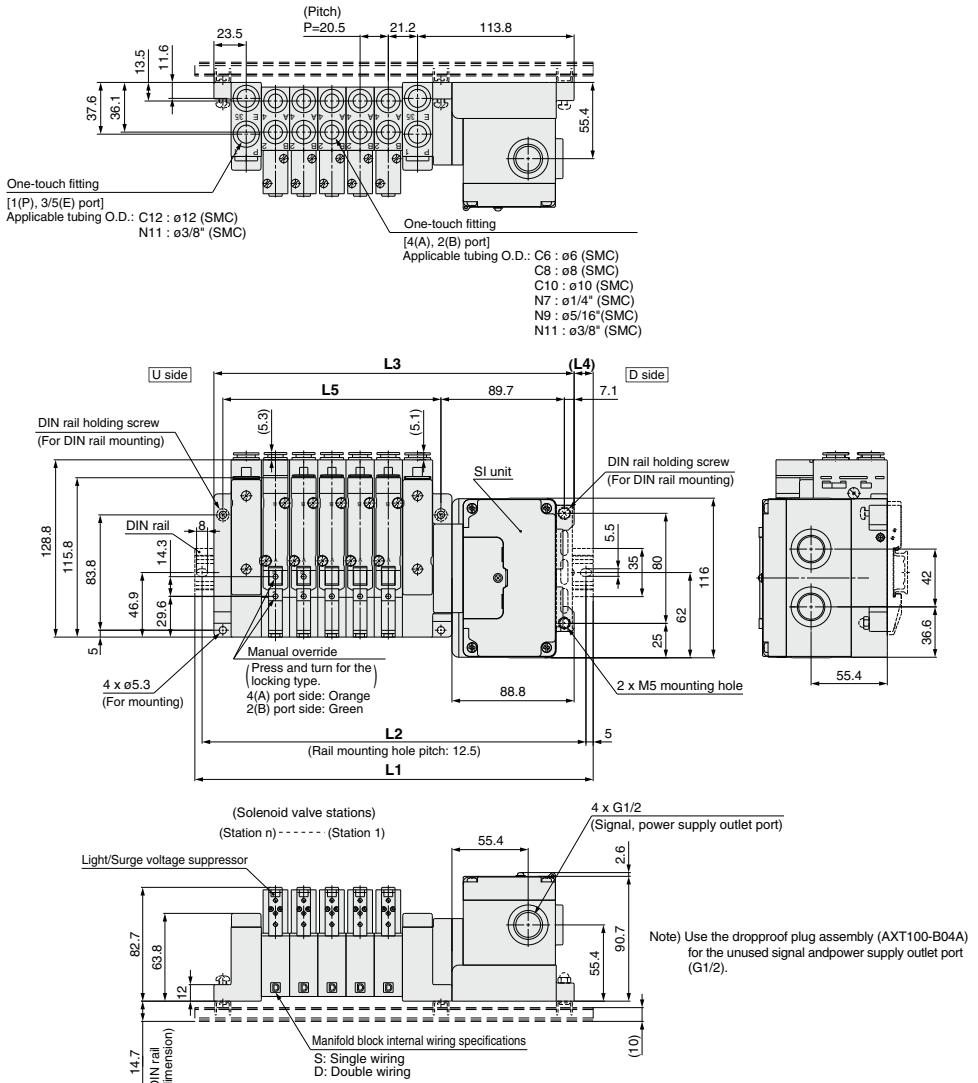

L Dimension

n : Stations

| n | 2 | 3 | 4 | 5 | 6 | 7 | 8 | 9 | 10 | 11 | 12 | 13 | 14 | 15 | 16 |
|----|-------|-------|-------|-------|-------|-------|-------|-------|-------|-------|-------|-------|-------|-------|-------|
| L1 | 235.5 | 248 | 273 | 285.5 | 310.5 | 335.5 | 348 | 373 | 398 | 410.5 | 435.5 | 460.5 | 473 | 498 | 510.5 |
| L2 | 225 | 237.5 | 262.5 | 275 | 300 | 325 | 337.5 | 362.5 | 387.5 | 400 | 425 | 450 | 462.5 | 487.5 | 500 |
| L3 | 200.3 | 220.8 | 241.3 | 261.8 | 282.3 | 302.8 | 323.3 | 343.8 | 364.3 | 384.8 | 405.3 | 425.8 | 446.3 | 466.8 | 487.3 |
| L4 | 17.5 | 13.5 | 16 | 12 | 14 | 16.5 | 12.5 | 14.5 | 17 | 13 | 15 | 17.5 | 13.5 | 15.5 | 11.5 |
| L5 | 97 | 117.5 | 138 | 158.5 | 179 | 199.5 | 220 | 240.5 | 261 | 281.5 | 302 | 322.5 | 343 | 363.5 | 384 |

Integrated-type (For Output) Serial Transmission System

EX120 Series

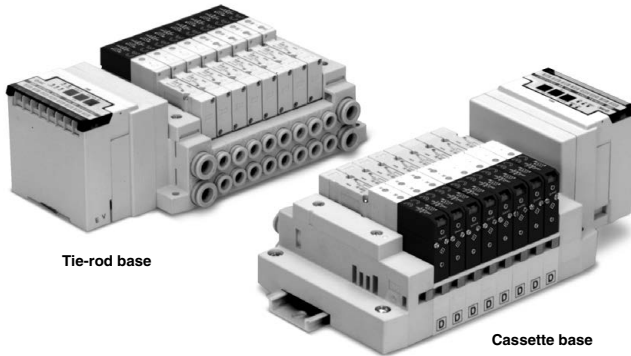

Tie-rod base

Cassette base

Applicable series

**Cassette base manifold
SV1000/SV2000**

**Tie-rod base manifold
SV1000/SV2000/SV3000/SV4000**

• Number of outputs points: 16 points

EX120 Integrated-type (For Output) Serial Transmission System

SV Series



How to Order Manifold

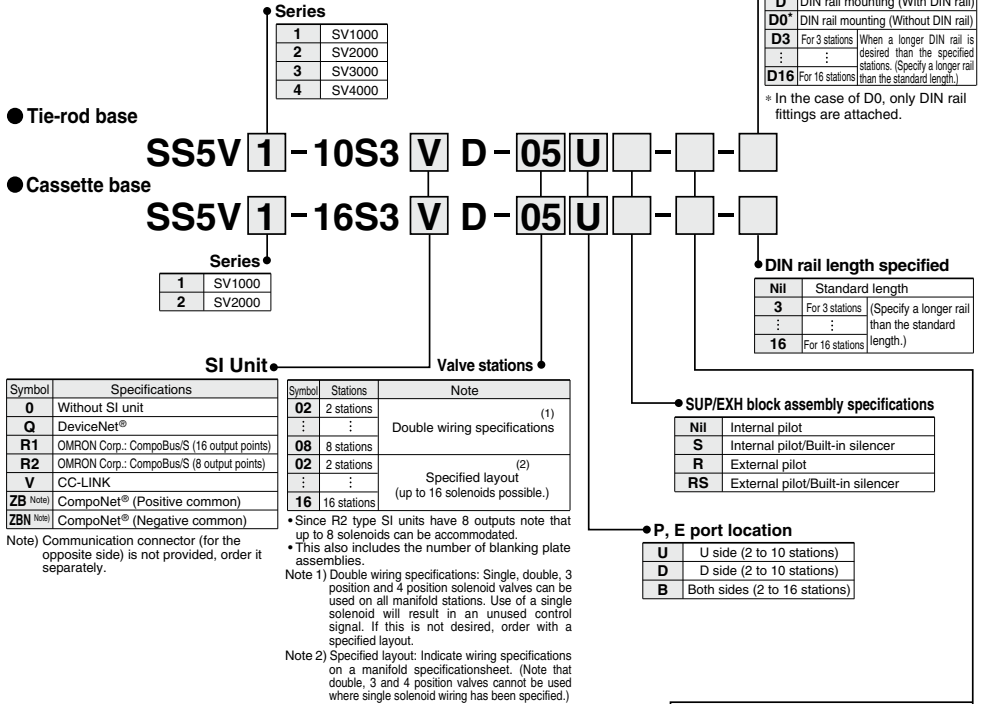

SI Unit Part No.

| Symbol | Protocol type | SI unit part no. |
|------------|--|------------------|
| Q | DeviceNet® | EX120-SDN1 |
| R1 | OMRON Corp.: CompoBus/S (16 output points) | EX120-SCS1 |
| R2 | OMRON Corp.: CompoBus/S (8 output points) | EX120-SCS2 |
| V | CC-LINK | EX120-SMJ1 |
| ZB | CompoNet® (Positive common) | EX120-SCM1 |
| ZBN | CompoNet® (Negative common) | EX120-SCM3 |

Refer to the **Web Catalog** and the Operation Manual for the details of EX120 Integrated-type (For Output) Serial Transmission System. Please download the Operation Manual via our website, <https://www.smcworld.com>.

A, B port size (Metric)

| Symbol | A, B port | P, E port | Applicable series |
|------------|----------------------------|---------------------------|-------------------|
| C3 | One-touch fitting for ø3.2 | One-touch fitting for ø8 | SV1000 |
| C4 | One-touch fitting for ø4 | | |
| C6 | One-touch fitting for ø6 | One-touch fitting for ø10 | SV2000 |
| C4 | One-touch fitting for ø4 | | |
| C8 | One-touch fitting for ø8 | One-touch fitting for ø12 | SV3000 |
| C6 | One-touch fitting for ø6 | | |
| C8 | One-touch fitting for ø8 | One-touch fitting for ø12 | SV4000 |
| C10 | One-touch fitting for ø10 | | |
| C12 | One-touch fitting for ø12 | Rc 3/8 | SV4000 |
| 02 | Rc 1/4 | | |
| 03 | Rc 3/8 | G 3/8 | SV4000 |
| 02F | G 1/4 | | |
| 03F | G 3/8 | | |
| M | A, B ports mixed | | |

A, B port size (Inch)

| Symbol | A, B port | P, E port | Applicable series |
|------------|------------------------------|------------------------------|-------------------|
| N1 | One-touch fitting for ø1/8" | One-touch fitting for ø5/16" | SV1000 |
| N3 | One-touch fitting for ø5/32" | | |
| N7 | One-touch fitting for ø1/4" | One-touch fitting for ø3/8" | SV2000 |
| N3 | One-touch fitting for ø5/32" | | |
| N7 | One-touch fitting for ø1/4" | One-touch fitting for ø3/8" | SV3000 |
| N9 | One-touch fitting for ø5/16" | | |
| N7 | One-touch fitting for ø1/4" | One-touch fitting for ø3/8" | SV4000 |
| N9 | One-touch fitting for ø5/16" | | |
| N11 | One-touch fitting for ø3/8" | NPT 3/8 | SV4000 |
| 02N | NPT 1/4 | | |
| 03N | NPT 3/8 | NPTF 3/8 | SV4000 |
| 02T | NPTF 1/4 | | |
| 03T | NPTF 3/8 | | |
| M | A, B ports mixed | | |

* In the case of mixed specifications (M), indicate separately on the manifold specification sheet.
* Port sizes of X, PE port for external pilot specification (R, RS) are ø4 (metric), ø5/32" (inch) for SV1000/2000 and ø6 (metric) and ø1/4" (inch) for SV3000/4000.

How to Order Manifold Assembly

Ordering example (SV1000)

Manifold
SS5V1-16S3AD-06B-C6 (1 set)

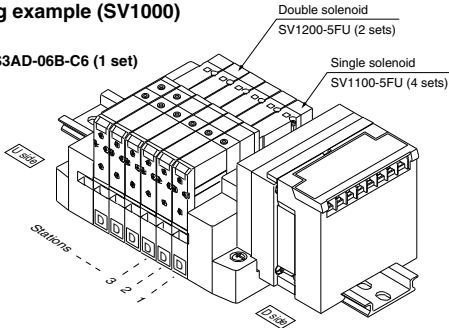

SS5V1-16S3CD-06B-C6 1 set (manifold part no.)
 * SV1100-5FU 4 sets (Single solenoid part no.)
 * SV1200-5FU 2 sets (Double solenoid part no.)

How to Order Solenoid Valves

SV 1 1 00 - 5 F - [] - [] (Note)

Series

| | |
|---|--------|
| 1 | SV1000 |
| 2 | SV2000 |
| 3 | SV3000 |
| 4 | SV4000 |

Type of actuation

| | |
|---|---|
| 1 | 2 position single |
| 2 | 2 position double |
| 3 | 3 position closed center |
| 4 | 3 position exhaust center |
| 5 | 3 position pressure center |
| A | 4 position dual 3 port valve: N.C./N.C. |
| B | 4 position dual 3 port valve: N.O./N.O. |
| C | 4 position dual 3 port valve: N.C./N.O. |

* 4 position dual 3 port valves are applicable to the SV1000 and SV2000 series only.

Pilot type

| | |
|-----|----------------|
| Nil | Internal pilot |
| R | External pilot |

* External pilot specifications is not available for 4 position dual 3 port valves.

Note) Available with manifold block for station additions. Refer to pages 113 and 119.

Made to Order

| | |
|-----|---|
| Nil | — |
| X90 | Main valve fluoro rubber (Refer to page 134.) |

Manual override

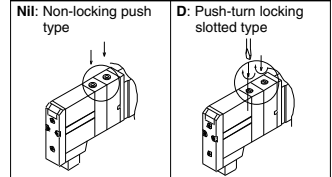

Light/Surge voltage suppressor

| | |
|---|-------------------------------------|
| U | With light/surge voltage suppressor |
| R | With surge voltage suppressor |

Rated voltage

| | |
|---|--------|
| 5 | 24 VDC |
|---|--------|

Back pressure check valve

| | |
|-----|----------|
| Nil | None |
| K | Built-in |

* Built-in back pressure check valve type is applicable to the SV1000 series only.
 * Back pressure check valve is not available for 3 position Valve.

Note) Refer to Specific Product Precautions 2 on page 136.

Dimensions: SV2000 Series for EX120 Integrated-type (For Output) Serial Transmission System

● Cassette base manifold : SS5V2-16S3 □ D- Stations $\frac{U}{B}$ (S, R, RS) $\frac{C4, N3}{C6, N7}$ $\frac{C8, N6}{C8, N6}$

- When P, E port outlets are indicated on the U side or D side, the P, E ports on the opposite side are plugged.
- External pilot port positions and silencer discharge port positions are the same as P, E port outlet positions.

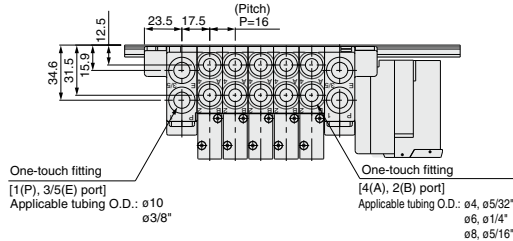

With External Pilot Specifications

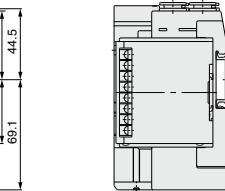
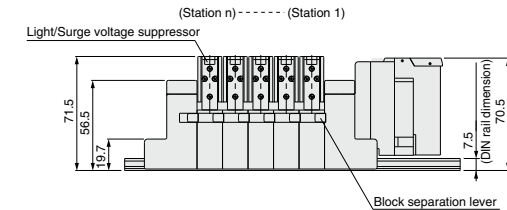
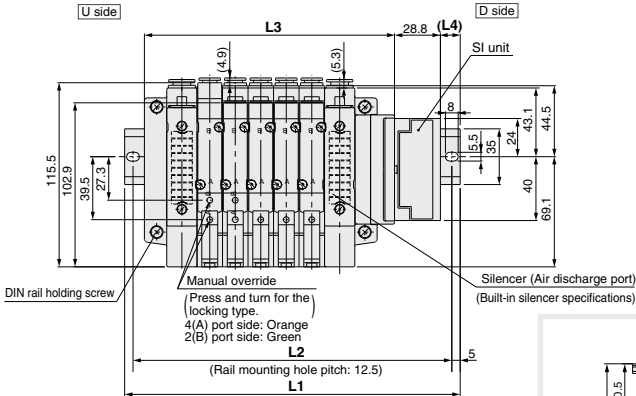
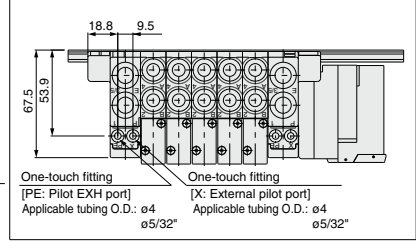

With option

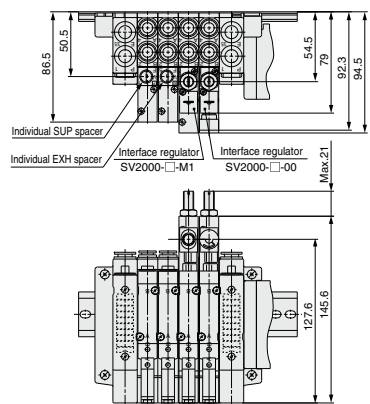

L Dimension

n : Stations

| n | 2 | 3 | 4 | 5 | 6 | 7 | 8 | 9 | 10 | 11 | 12 | 13 | 14 | 15 | 16 |
|----|-------|-------|-------|-------|-------|-------|-------|-------|-------|-------|-------|-------|-------|-------|-------|
| L1 | 173 | 185.5 | 198 | 210.5 | 235.5 | 248 | 260.5 | 273 | 298 | 310.5 | 323 | 348 | 360.5 | 373 | 385.5 |
| L2 | 162.5 | 175 | 187.5 | 200 | 225 | 237.5 | 250 | 262.5 | 287.5 | 300 | 312.5 | 337.5 | 350 | 362.5 | 375 |
| L3 | 108.9 | 124.9 | 140.9 | 156.9 | 172.9 | 188.9 | 204.9 | 220.9 | 236.9 | 252.9 | 268.9 | 284.9 | 300.9 | 316.9 | 332.9 |
| L4 | 17.5 | 16 | 14 | 12.5 | 17 | 15 | 13.5 | 11.5 | 16 | 14.5 | 12.5 | 17 | 15.5 | 13.5 | 12 |

SV Series

Dimensions: SV3000 Series for EX120 Integrated-type (For Output) Serial Transmission System

● Tie-rod base manifold : SS5V3-10S3 □ D- Stations $\frac{U}{D}$ (S, R, RS) $\frac{C6, N7}{C10, N6, N11}$ (-D)

- When P, E port outlets are indicated on the U side or D side, the P, E ports on the opposite side are plugged.
- External pilot port positions and silencer discharge port positions are the same as P, E port outlet positions.

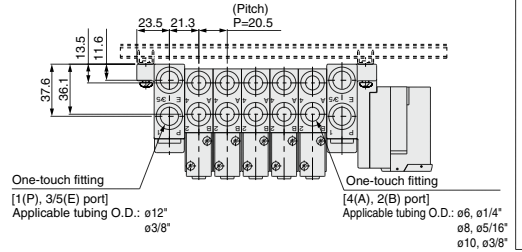

With External Pilot Specifications

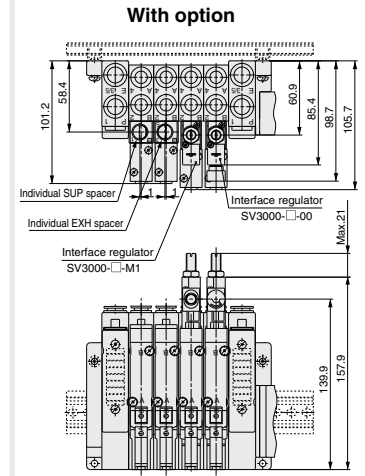
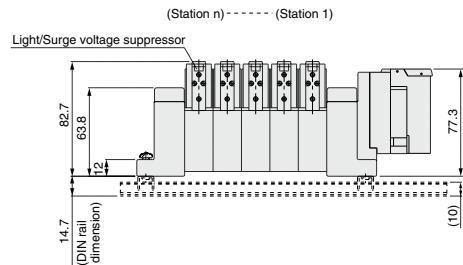
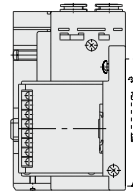
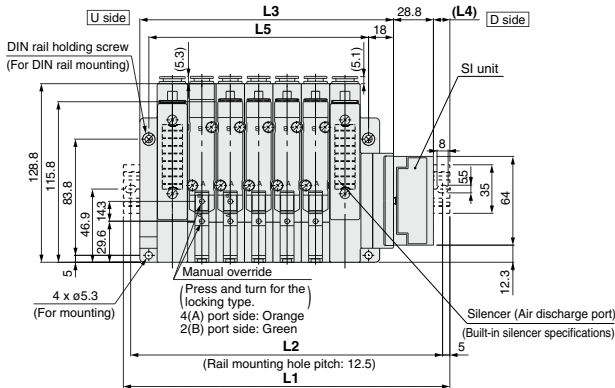
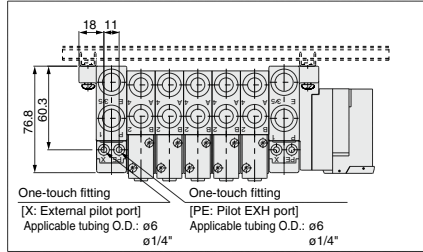

L Dimension

| L | 2 | 3 | 4 | 5 | 6 | 7 | 8 | 9 | 10 | 11 | 12 | 13 | 14 | 15 | 16 |
|----|-------|-------|-------|-------|-------|-------|-------|-------|-------|-------|-------|-------|-------|-------|-------|
| L1 | 185.5 | 198 | 223 | 235.5 | 260.5 | 285.5 | 298 | 323 | 348 | 360.5 | 385.5 | 410.5 | 423 | 448 | 460.5 |
| L2 | 175 | 187.5 | 212.5 | 225 | 250 | 275 | 287.5 | 312.5 | 337.5 | 350 | 375 | 400 | 412.5 | 437.5 | 450 |
| L3 | 121.5 | 142 | 162.5 | 183 | 203.5 | 224 | 244.5 | 265 | 285.5 | 306 | 326.5 | 347 | 367.5 | 388 | 408.5 |
| L4 | 17.5 | 13.5 | 16 | 12 | 14 | 16.5 | 12.5 | 14.5 | 17 | 13 | 15 | 17.5 | 13.5 | 15.5 | 11.5 |
| L5 | 97 | 117.5 | 138 | 158.5 | 179 | 199.5 | 220 | 240.5 | 261 | 281.5 | 302 | 322.5 | 343 | 363.5 | 384 |

n : Stations

Circular Connector

IP67 compliant

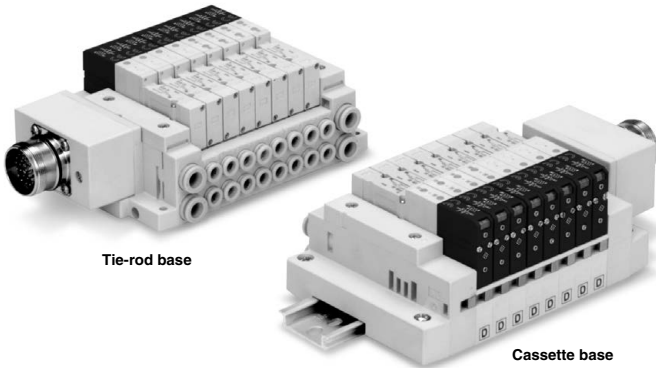

| | |
|---------------------------------|--|
| Applicable series | Cassette base manifold SV1000/SV2000 |
| | Tie-rod base manifold SV1000/SV2000/SV3000/SV4000 |
| • Number of connectors: 26 pins | |

Circular Connector SV Series



How to Order Manifold

Series

| | |
|---|--------|
| 1 | SV1000 |
| 2 | SV2000 |
| 3 | SV3000 |
| 4 | SV4000 |

Valve stations

| Symbol | Stations | Note |
|--------|-------------|--|
| 02 | 2 stations | Double wiring specifications (1) |
| : | : | |
| : | : | |
| 12 | 12 stations | Specified layout (2) (Up to 24 solenoids possible.) |
| 02 | 2 stations | |
| : | : | |
| 20 | 20 stations | |

Mounting

| Nil | Direct mounting |
|-----|--------------------------------------|
| D | DIN rail mounting (With DIN rail) |
| D0 | DIN rail mounting (Without DIN rail) |
| D3 | For 3 stations |
| : | : |
| : | : |
| D20 | For 20 stations |

DIN rail length specified

| Nil | Standard length |
|---------------------|-----------------|
| 3 | For 3 stations |
| : | : |
| : | : |
| 20 ^{Note)} | For 20 stations |

A, B port size (Metric)

| Symbol | Specifications | P, E port | Applicable series |
|--------|----------------------------|---------------------------|-------------------|
| C3 | One-touch fitting for ø3.2 | One-touch fitting for ø8 | SV1000 |
| C4 | One-touch fitting for ø4 | | |
| C6 | One-touch fitting for ø6 | | |
| C4 | One-touch fitting for ø4 | One-touch fitting for ø10 | SV2000 |
| C6 | One-touch fitting for ø6 | | |
| C8 | One-touch fitting for ø8 | | |
| C6 | One-touch fitting for ø6 | One-touch fitting for ø12 | SV3000 |
| C8 | One-touch fitting for ø8 | | |
| C10 | One-touch fitting for ø10 | | |
| C8 | One-touch fitting for ø8 | One-touch fitting for ø12 | SV4000 |
| C10 | One-touch fitting for ø10 | | |
| C12 | One-touch fitting for ø12 | | |
| 02 | Rc 1/4 | Rc 3/8 | |
| 03 | Rc 3/8 | | |
| 02F | G 1/4 | | |
| 03F | G 3/8 | G 3/8 | |
| M | A, B ports mixed | | |

A, B port size (Inch)

| Symbol | Specifications | P, E port | Applicable series |
|--------|------------------------------|------------------------------|-------------------|
| N1 | One-touch fitting for ø1/8" | One-touch fitting for ø5/16" | SV1000 |
| N3 | One-touch fitting for ø5/32" | | |
| N7 | One-touch fitting for ø1/4" | | |
| N3 | One-touch fitting for ø5/32" | One-touch fitting for ø3/8" | SV2000 |
| N7 | One-touch fitting for ø1/4" | | |
| N9 | One-touch fitting for ø5/16" | | |
| N7 | One-touch fitting for ø1/4" | One-touch fitting for ø3/8" | SV3000 |
| N9 | One-touch fitting for ø5/16" | | |
| N11 | One-touch fitting for ø3/8" | | |
| N9 | One-touch fitting for ø5/16" | One-touch fitting for ø3/8" | SV4000 |
| N11 | One-touch fitting for ø3/8" | | |
| 02N | NPT 1/4 | | |
| 03N | NPT 3/8 | NPT 3/8 | |
| 02T | NPTF 1/4 | NPTF 3/8 | |
| 03T | NPTF 3/8 | | |
| M | A, B ports mixed | | |

P, E port location

| | |
|---|-------------------------------|
| U | U side (2 to 10 stations) |
| D | D side (2 to 10 stations) |
| B | Both sides (2 to 20 stations) |

SUP/EXH block assembly specifications

| | |
|-----|----------------------------------|
| Nil | Internal pilot |
| S* | Internal pilot/Built-in silencer |
| R | External pilot |
| RS* | External pilot/Built-in silencer |

Enclosure IP67 specifications

Valve stations Type 16: SV1000 series

| Symbol | Stations | Note |
|--------|-------------|--|
| 02 | 2 stations | Double wiring specifications (1) |
| : | : | |
| : | : | |
| 09 | 9 stations | Specified layout (2) (up to 18 solenoids possible.) |
| 02 | 2 stations | |
| : | : | |
| 18 | 18 stations | |

Type 16: SV2000 series

| Symbol | Stations | Note |
|--------|-------------|--|
| 02 | 2 stations | Double wiring specifications (1) |
| : | : | |
| : | : | |
| 12 | 12 stations | Specified layout (2) (up to 24 solenoids possible.) |
| 02 | 2 stations | |
| : | : | |
| 20 | 20 stations | |

Note 1) Double wiring specifications: Single, double, 3 position and 4 position solenoid valves can be used at all of the manifold stations. Use of a single solenoid will result in an unused control signal. If this is not desired, order with a specified layout.

Note 2) Specified layout: Indicate wiring specifications on the manifold specification sheet. (Note that double, 3 and 4 position valves cannot be used where single solenoid wiring has been specified.)

Note) When the built-in silencer type is used, keep the exhaust port from coming in direct contact with water or other liquids.



How to Order Manifold Assembly

Ordering example (SV1000)

Manifold
SS5V1-W16CD-06B-C6 (1 set)

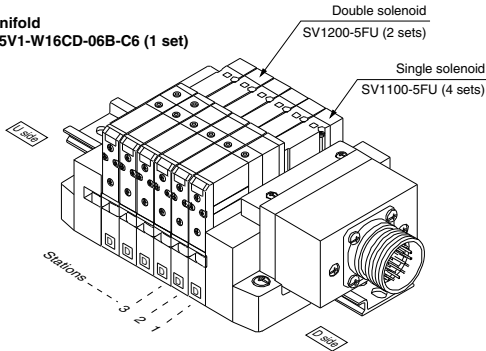

SS5V1-W16CD-06B-C6.....1 set (Manifold part no.)
* SV1100-5FU.....4 sets (Single solenoid part no.)
* SV1200-5FU.....2 sets (Double solenoid part no.)

How to Order Solenoid Valves

SV 1 1 0 0 - 5 F - - -

Series ●

| | |
|---|--------|
| 1 | SV1000 |
| 2 | SV2000 |
| 3 | SV3000 |
| 4 | SV4000 |

Type of actuation ●

| | |
|---|---|
| 1 | 2 position single |
| 2 | 2 position double |
| 3 | 3 position closed center |
| 4 | 3 position exhaust center |
| 5 | 3 position pressure center |
| A | 4 position dual 3 port valve: N.C./N.C. |
| B | 4 position dual 3 port valve: N.O./N.O. |
| C | 4 position dual 3 port valve: N.C./N.O. |

* 4 position dual 3 port valves are applicable to the SV1000 and SV2000 series only.

Pilot type ●

| | |
|-----|----------------|
| Nil | Internal pilot |
| R | External pilot |

* External pilot specifications is not available for 4 position dual 3 port valves.

Back pressure check valve ●

| | |
|-----|----------|
| Nil | None |
| K | Built-in |

* Built-in back pressure check valve type is applicable to the SV1000 series only.
* Back pressure check valve is not available for 3 position valve.

Rated voltage ●

| | |
|---|--------|
| 5 | 24 VDC |
| 6 | 12 VDC |

Note)

Note) Available with manifold block for station additions. Refer to pages 113 and 119.

Made to Order ●

| | |
|-----|--|
| Nil | — |
| X90 | Main valve fluororubber (Refer to page 134.) |

Manual override ●

Nil: Non-locking push type

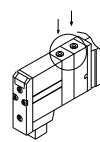

D: Push-turn locking slotted type

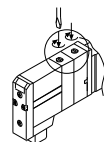

Light/Surge voltage suppressor ●

| | |
|---|-------------------------------------|
| U | With light/surge voltage suppressor |
| R | With surge voltage suppressor |

Note) Refer to Specific Product Precautions 2 on page 136.

Manifold Electrical Wiring

| 10C/16C Circular Connector Type (26 pins) | | |
|---|--------------|----------|
| | Terminal no. | Polarity |
| Station 1 | SOL_01 | (-) (+) |
| | SOL_02 | (-) (+) |
| Station 2 | SOL_03 | (-) (+) |
| | SOL_04 | (-) (+) |
| Station 3 | SOL_05 | (-) (+) |
| | SOL_06 | (-) (+) |
| Station 4 | SOL_07 | (-) (+) |
| | SOL_08 | (-) (+) |
| Station 5 | SOL_09 | (-) (+) |
| | SOL_10 | (-) (+) |
| Station 6 | SOL_11 | (-) (+) |
| | SOL_12 | (-) (+) |
| Station 7 | SOL_13 | (-) (+) |
| | SOL_14 | (-) (+) |
| Station 8 | SOL_15 | (-) (+) |
| | SOL_16 | (-) (+) |
| Station 9 | SOL_17 | (-) (+) |
| | SOL_18 | (-) (+) |
| Station 10 | SOL_19 | (-) (+) |
| | SOL_20 | (-) (+) |
| Station 11 | SOL_21 | (-) (+) |
| | SOL_22 | (-) (+) |
| Station 12 | SOL_23 | (-) (+) |
| | SOL_24 | (-) (+) |
| | COM_25 | (+) (-) |
| | COM_26 | (+) (-) |

Positive common specification Negative common specification

- This circuit has double wiring specifications for up to 12 stations. Since the usable number of solenoids differs depending on the manifold type, refer to the table below. In the case of single solenoids, connect to SOL_ A. Furthermore, when wiring is specified on a manifold specification sheet, connections are made without skipping any connectors, and connections are made without skipping any connectors, and signals A for single and A, B for double are in order 1→2 → 3 → 4, etc.
- Stations are counted from D side (connector side) as the 1st.
- Since solenoid valves do not have polarity, either the +COM or -COM can be used.

Usable No. of Solenoids

| Model | | Max. no. of solenoids |
|-----------------------|-----------|-----------------------|
| Tie-rod base type 10 | SV1000 | 24 |
| | to SV4000 | |
| Cassette base type 16 | SV1000 | 18 |
| | SV2000 | 24 |

Dimensions: SV1000 Series for Circular Connector

● **Cassette base manifold: SS5V1-W16CD-(Stations) $\frac{U}{D}$ (S, R, RS)-** C3, N1
C4, N3
C5, N7

- When P, E port outlets are indicated on the U side or D side, the P, E ports on the opposite side are plugged.
- External pilot port positions and silencer discharge port positions are the same as P, E port outlet positions.

With External Pilot Specifications

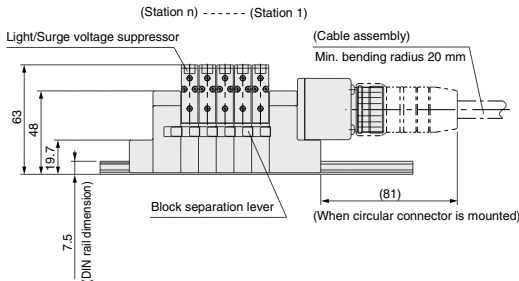
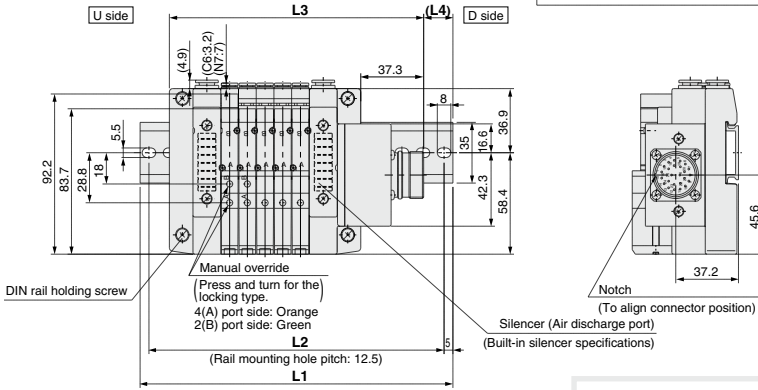
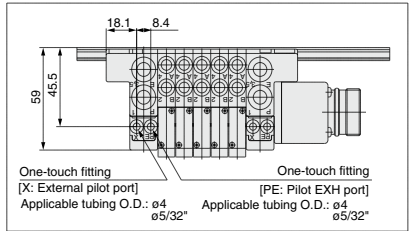
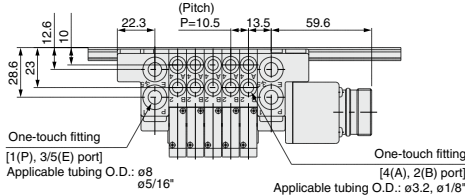

With option

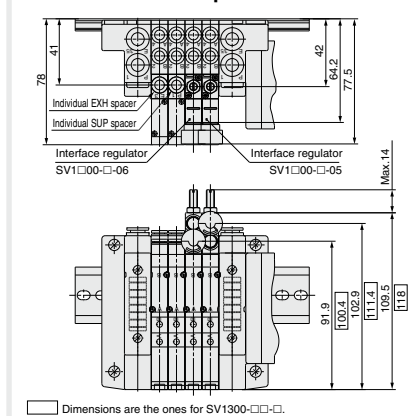

L Dimension

| n | 2 | 3 | 4 | 5 | 6 | 7 | 8 | 9 | 10 | 11 | 12 | 13 | 14 | 15 | 16 | 17 | 18 |
|----|-------|-------|-------|-------|-------|-------|-------|-------|-------|-------|-------|-------|-------|-------|-------|-------|-------|
| L1 | 148 | 160.5 | 173 | 185.5 | 185.5 | 198 | 210.5 | 223 | 235.5 | 248 | 248 | 260.5 | 273 | 285.5 | 298 | 310.5 | 310.5 |
| L2 | 137.5 | 150 | 162.5 | 175 | 175 | 187.5 | 200 | 212.5 | 225 | 237.5 | 237.5 | 250 | 262.5 | 275 | 287.5 | 300 | 300 |
| L3 | 119.3 | 129.8 | 140.3 | 150.8 | 161.3 | 171.8 | 182.3 | 192.8 | 203.3 | 213.8 | 224.3 | 234.8 | 245.3 | 255.8 | 266.3 | 276.8 | 287.3 |
| L4 | 14.5 | 15.5 | 16.5 | 17.5 | 12 | 13 | 14 | 15 | 16 | 17 | 12 | 13 | 14 | 15 | 16 | 17 | 11.5 |

Dimensions: SV2000 Series for Circular Connector

● Cassette base manifold: SS5V2-W16CD-(Stations) $\frac{U}{D}$ (S, R, RS)- C4, N3 C6, N7 C8, N9

- When P, E port outlets are indicated on the U side or D side, the P, E ports on the opposite side are plugged.
- External pilot port positions and silencer discharge port positions are the same as P, E port outlet positions.

With External Pilot Specifications

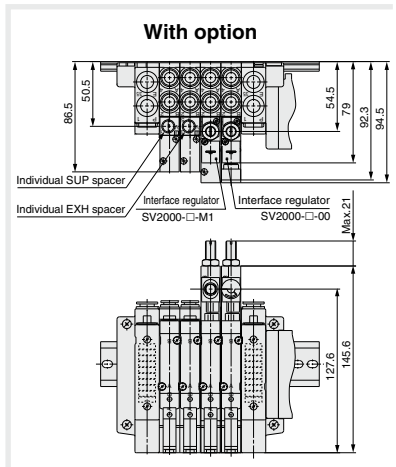
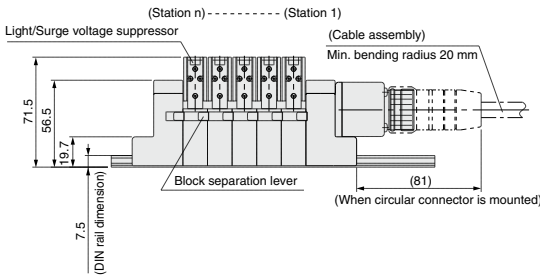
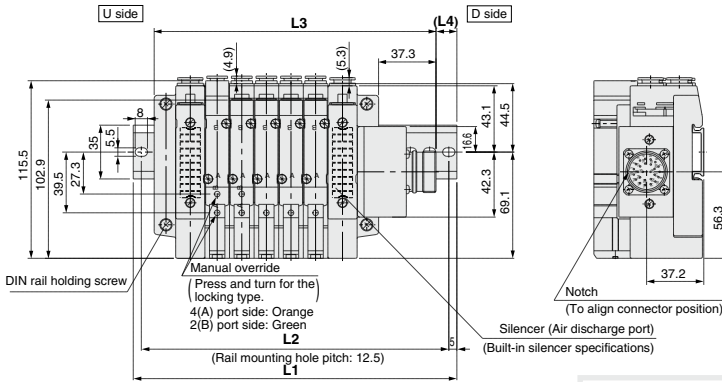
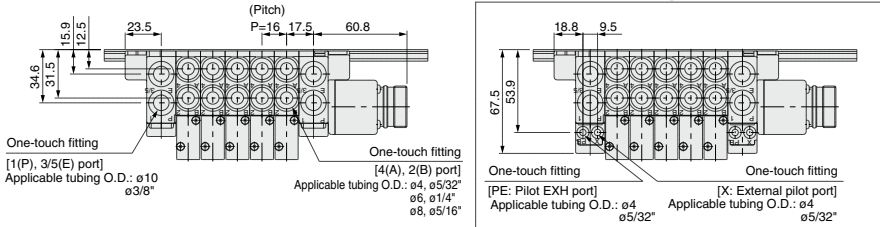

L Dimension

| n | 2 | 3 | 4 | 5 | 6 | 7 | 8 | 9 | 10 | 11 | 12 | 13 | 14 | 15 | 16 | 17 | 18 | 19 | 20 |
|----|-------|-------|-------|-------|-------|-------|-------|-------|-------|-------|-------|-------|-------|-------|-------|-------|-------|-------|-------|
| L1 | 160.5 | 185.5 | 198 | 210.5 | 223 | 248 | 260.5 | 273 | 298 | 310.5 | 323 | 335.5 | 360.5 | 373 | 385.5 | 410.5 | 423 | 435.5 | 448 |
| L2 | 150 | 175 | 187.5 | 200 | 212.5 | 237.5 | 250 | 262.5 | 287.5 | 300 | 312.5 | 325 | 350 | 362.5 | 375 | 400 | 412.5 | 425 | 437.5 |
| L3 | 135.3 | 151.3 | 167.3 | 183.3 | 199.3 | 215.3 | 231.3 | 247.3 | 263.3 | 279.3 | 295.3 | 311.3 | 327.3 | 343.3 | 359.3 | 375.3 | 391.3 | 407.3 | 423.3 |
| L4 | 12.5 | 17 | 15.5 | 13.5 | 12 | 16.5 | 14.5 | 13 | 17.5 | 15.5 | 14 | 12 | 16.5 | 15 | 13 | 17.5 | 16 | 14 | 12.5 |

Dimensions: SV1000 Series for Circular Connector

● Tie-rod base manifold: SS5V1-W10CD-(Stations) $\frac{U}{D}$ (S, R, RS)-C3, N1
C4, N3 (-D)
C6, N7

- When P, E port outlets are indicated on the U side or D side, the P, E ports on the opposite side are plugged.
- External pilot port positions and silencer discharge port positions are the same as P, E port outlet positions.

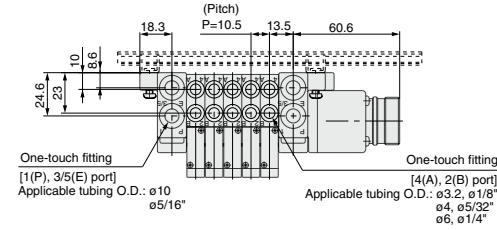

With External Pilot Specifications

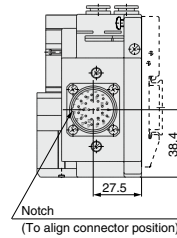
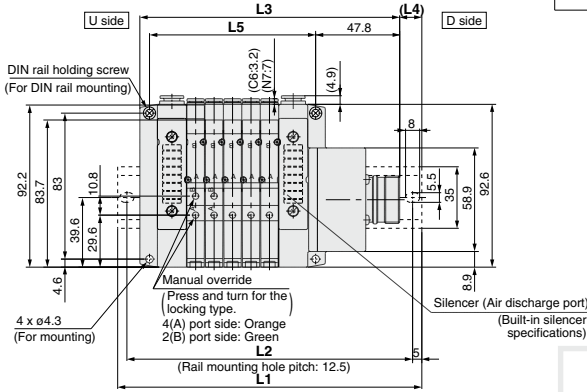
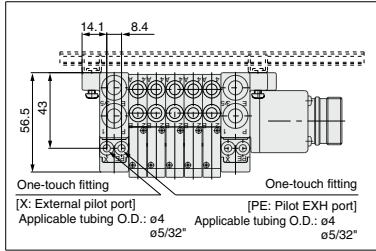

With option

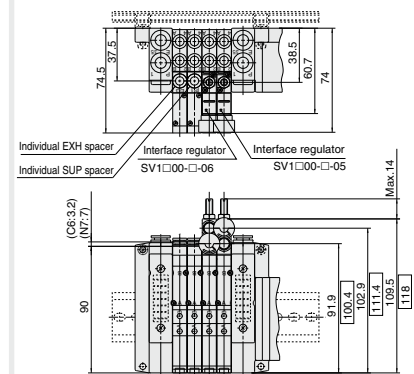
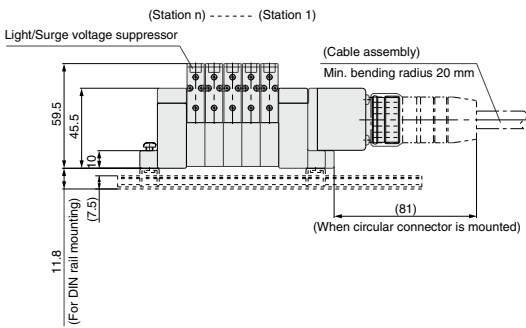

□ Dimensions are the ones for SV1300-□-□.

L Dimension

| n | 2 | 3 | 4 | 5 | 6 | 7 | 8 | 9 | 10 | 11 | 12 | 13 | 14 | 15 | 16 | 17 | 18 | 19 | 20 |
|----|-------|-------|-------|-------|-------|-------|-------|-------|-------|-------|-------|-------|-------|-------|-------|-------|-------|-------|-------|
| L1 | 148 | 160.5 | 160.5 | 173 | 185.5 | 198 | 210.5 | 223 | 235.5 | 235.5 | 248 | 260.5 | 273 | 285.5 | 298 | 298 | 310.5 | 323 | 335.5 |
| L2 | 137.5 | 150 | 150 | 162.5 | 175 | 187.5 | 200 | 212.5 | 225 | 225 | 237.5 | 250 | 262.5 | 275 | 287.5 | 287.5 | 300 | 312.5 | 325 |
| L3 | 116.3 | 128.8 | 137.3 | 147.8 | 158.3 | 168.8 | 179.3 | 189.8 | 200.3 | 210.8 | 221.3 | 231.8 | 242.3 | 252.8 | 263.3 | 273.8 | 284.3 | 294.8 | 305.3 |
| L4 | 16 | 17 | 11.5 | 12.5 | 13.5 | 14.5 | 15.5 | 16.5 | 17.5 | 12.5 | 13.5 | 14.5 | 15.5 | 16.5 | 17.5 | 12 | 13 | 14 | 15 |
| L5 | 63 | 73.5 | 84 | 94.5 | 105 | 115.5 | 126 | 136.5 | 147 | 157.5 | 168 | 178.5 | 189 | 199.5 | 210 | 220.5 | 231 | 241.5 | 252 |

n: Stations

SV Series

Dimensions: SV2000 Series for Circular Connector

● Tie-rod base manifold: SS5V2-W10CD-Stations U (S, R, RS) D (S, R, RS) C4, N3 C6, N7 C8, N8 (-D)

- When P, E port outlets are indicated on the U side or D side, the P, E ports on the opposite side are plugged.
- External pilot port positions and silencer discharge port positions are the same as P, E port outlet positions.

With External Pilot Specifications

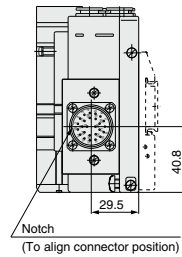
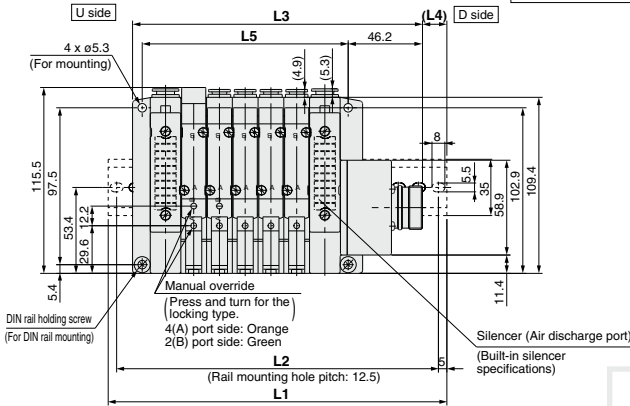
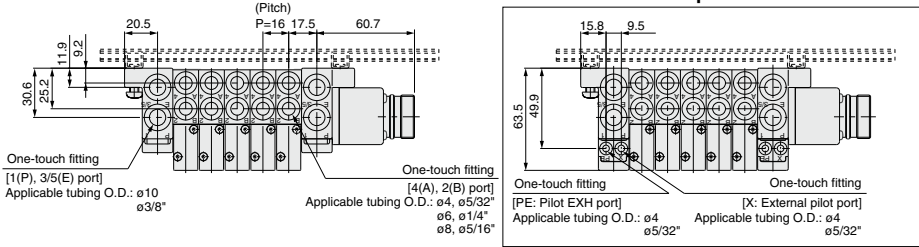

With option

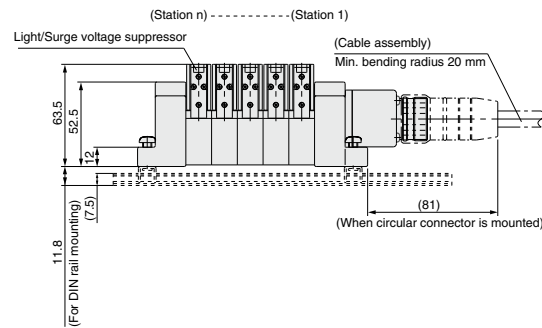
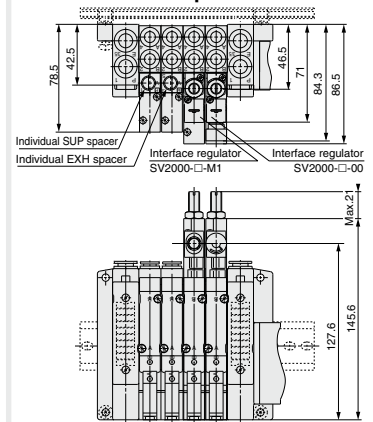

L Dimension

| n | 2 | 3 | 4 | 5 | 6 | 7 | 8 | 9 | 10 | 11 | 12 | 13 | 14 | 15 | 16 | 17 | 18 | 19 | 20 |
|----|-------|-------|-------|-------|-------|-------|-------|-------|-------|-------|-------|-------|-------|-------|-------|-------|-------|-------|-------|
| L1 | 160.5 | 173 | 198 | 210.5 | 223 | 235.5 | 260.5 | 273 | 285.5 | 310.5 | 323 | 335.5 | 348 | 373 | 385.5 | 398 | 423 | 435.5 | 448 |
| L2 | 150 | 162.5 | 187.5 | 200 | 212.5 | 225 | 250 | 262.5 | 275 | 300 | 312.5 | 325 | 337.5 | 362.5 | 375 | 387.5 | 412.5 | 425 | 437.5 |
| L3 | 132.2 | 148.2 | 164.2 | 180.2 | 196.2 | 212.2 | 228.2 | 244.2 | 260.2 | 276.2 | 292.2 | 308.2 | 324.2 | 340.2 | 356.2 | 372.2 | 388.2 | 404.2 | 420.2 |
| L4 | 14 | 12.5 | 17 | 15 | 13.5 | 11.5 | 16 | 14.5 | 12.5 | 17 | 15.5 | 13.5 | 12 | 16.5 | 14.5 | 13 | 17.5 | 15.5 | 14 |
| L5 | 80 | 96 | 112 | 128 | 144 | 160 | 176 | 192 | 208 | 224 | 240 | 256 | 272 | 288 | 304 | 320 | 336 | 352 | 368 |

Dimensions: SV3000 Series for Circular Connector

● Tie-rod base manifold: SS5V3-W10CD- $\frac{U}{D}$ (S, R, RS)-C6, N7
C8, N9
C10, N11 (-D)

- When P, E port outlets are indicated on the U side or D side, the P, E ports on the opposite side are plugged.
- External pilot port positions and silencer discharge port positions are the same as P, E port outlet positions.

With External Pilot Specifications

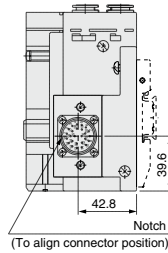
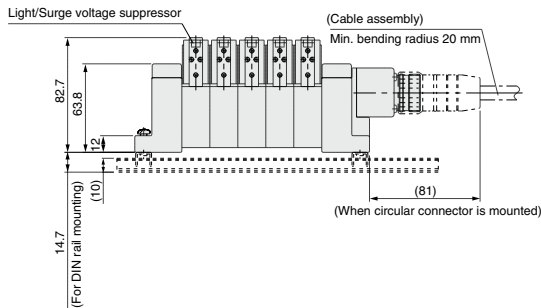
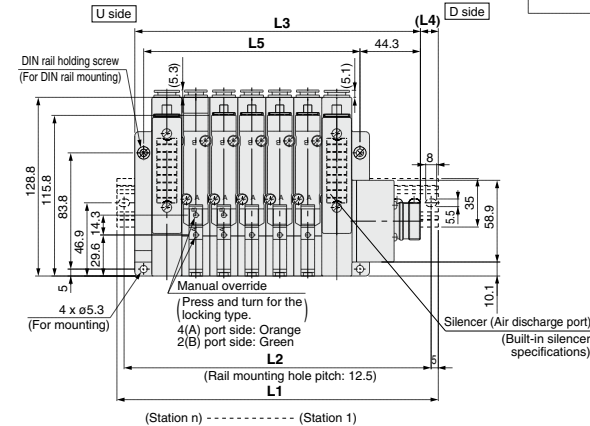
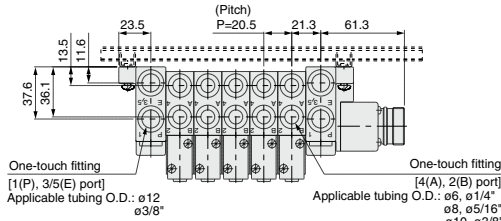
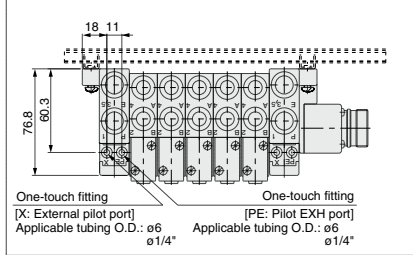

With option

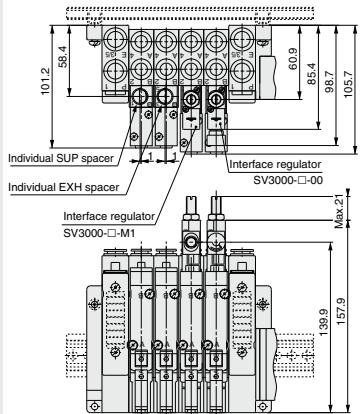

L Dimension

| n | 2 | 3 | 4 | 5 | 6 | 7 | 8 | 9 | 10 | 11 | 12 | 13 | 14 | 15 | 16 | 17 | 18 | 19 | 20 |
|----|-------|-------|-------|-------|-------|-------|-------|-------|-------|-------|-------|-------|-------|-------|-------|-------|-------|-------|-------|
| L1 | 173 | 198 | 223 | 235.5 | 260.5 | 285.5 | 298 | 323 | 335.5 | 360.5 | 385.5 | 398 | 423 | 448 | 460.5 | 485.5 | 510.5 | 523 | 548 |
| L2 | 162.5 | 187.5 | 212.5 | 225 | 250 | 275 | 287.5 | 312.5 | 325 | 350 | 375 | 387.5 | 412.5 | 437.5 | 450 | 475 | 500 | 512.5 | 537.5 |
| L3 | 147.8 | 168.3 | 188.8 | 209.3 | 229.8 | 250.3 | 270.8 | 291.3 | 311.8 | 332.3 | 352.8 | 373.3 | 393.8 | 414.3 | 434.8 | 455.3 | 475.8 | 496.3 | 516.8 |
| L4 | 12.5 | 15 | 17 | 13 | 15.5 | 17.5 | 13.5 | 16 | 12 | 14 | 16.5 | 12.5 | 14.5 | 17 | 13 | 15 | 17.5 | 13.5 | 15.5 |
| L5 | 97 | 117.5 | 138 | 158.5 | 179 | 199.5 | 220 | 240.5 | 261 | 281.5 | 302 | 322.5 | 343 | 363.5 | 384 | 404.5 | 425 | 445.5 | 466 |

n: Stations

SV Series

Dimensions: SV4000 Series for Circular Connector

● Tie-rod base manifold: SS5V4-W10CD- $\begin{matrix} \text{U} \\ \text{D} \end{matrix}$ (S, R, RS)- $\begin{matrix} \text{O}8 \\ \text{O}3, \text{C}10, \text{N}9 \\ \text{C}12, \text{N}11 \end{matrix}$ (-D)

- When P, E port outlets are indicated on the U side or D side, the P, E ports on the opposite side are plugged.
- External pilot port positions and silencer discharge port positions are the same as P, E port outlet positions.

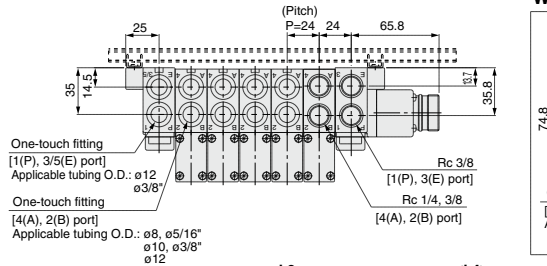

With External Pilot Specifications

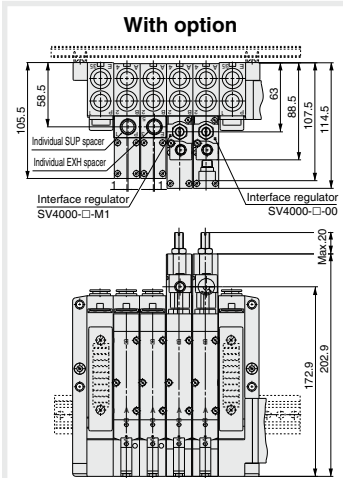
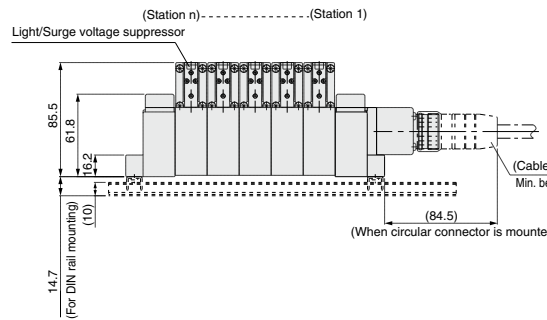
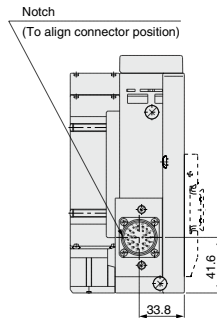
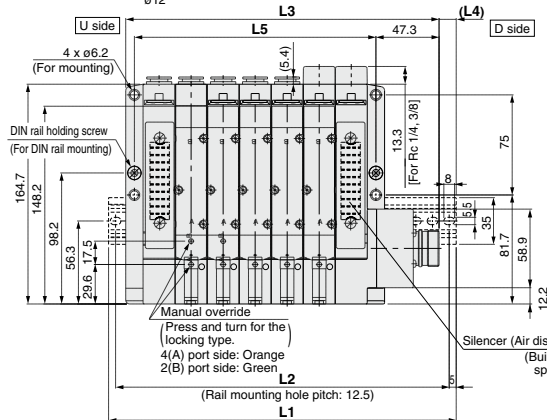
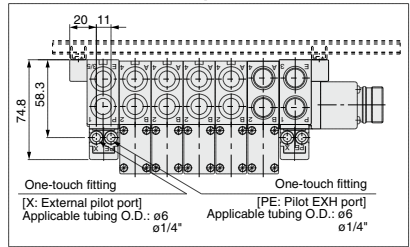

L Dimension

| n | 2 | 3 | 4 | 5 | 6 | 7 | 8 | 9 | 10 | 11 | 12 | 13 | 14 | 15 | 16 | 17 | 18 | 19 | 20 |
|----|-------|-------|-------|-------|-------|-------|-------|-------|-------|-------|-------|-------|-------|-------|-------|-------|-------|-------|-------|
| L1 | 198 | 210.5 | 235.5 | 260.5 | 285.5 | 310.5 | 335.5 | 360.5 | 385.5 | 410.5 | 435.5 | 460.5 | 485.5 | 498 | 523 | 548 | 573 | 598 | 623 |
| L2 | 187.5 | 200 | 225 | 250 | 275 | 300 | 325 | 350 | 375 | 400 | 425 | 450 | 475 | 487.5 | 512.5 | 537.5 | 562.5 | 587.5 | 612.5 |
| L3 | 162.8 | 186.8 | 210.8 | 234.8 | 258.8 | 282.8 | 306.8 | 330.8 | 354.8 | 378.8 | 402.8 | 426.8 | 450.8 | 474.8 | 498.8 | 522.8 | 546.8 | 570.8 | 594.8 |
| L4 | 17.5 | 12 | 12.5 | 13 | 13.5 | 14 | 14.5 | 15 | 15.5 | 16 | 16.5 | 17 | 17.5 | 11.5 | 12 | 12.5 | 13 | 13.5 | 14 |
| L5 | 109 | 133 | 157 | 181 | 205 | 229 | 253 | 277 | 301 | 325 | 349 | 373 | 397 | 421 | 445 | 469 | 493 | 517 | 541 |

D-sub Connector

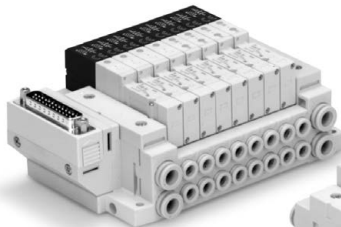

Tie-rod base

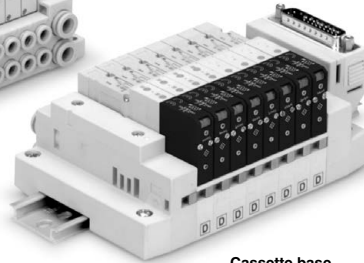

Cassette base

Applicable series

Cassette base manifold
SV1000/SV2000

Tie-rod base manifold
SV1000/SV2000/SV3000/SV4000

- Number of connectors: 25 pins
 - MIL-C-24308
- Conforming to JIS-X-5101

D-sub Connector SV Series



How to Order Manifold

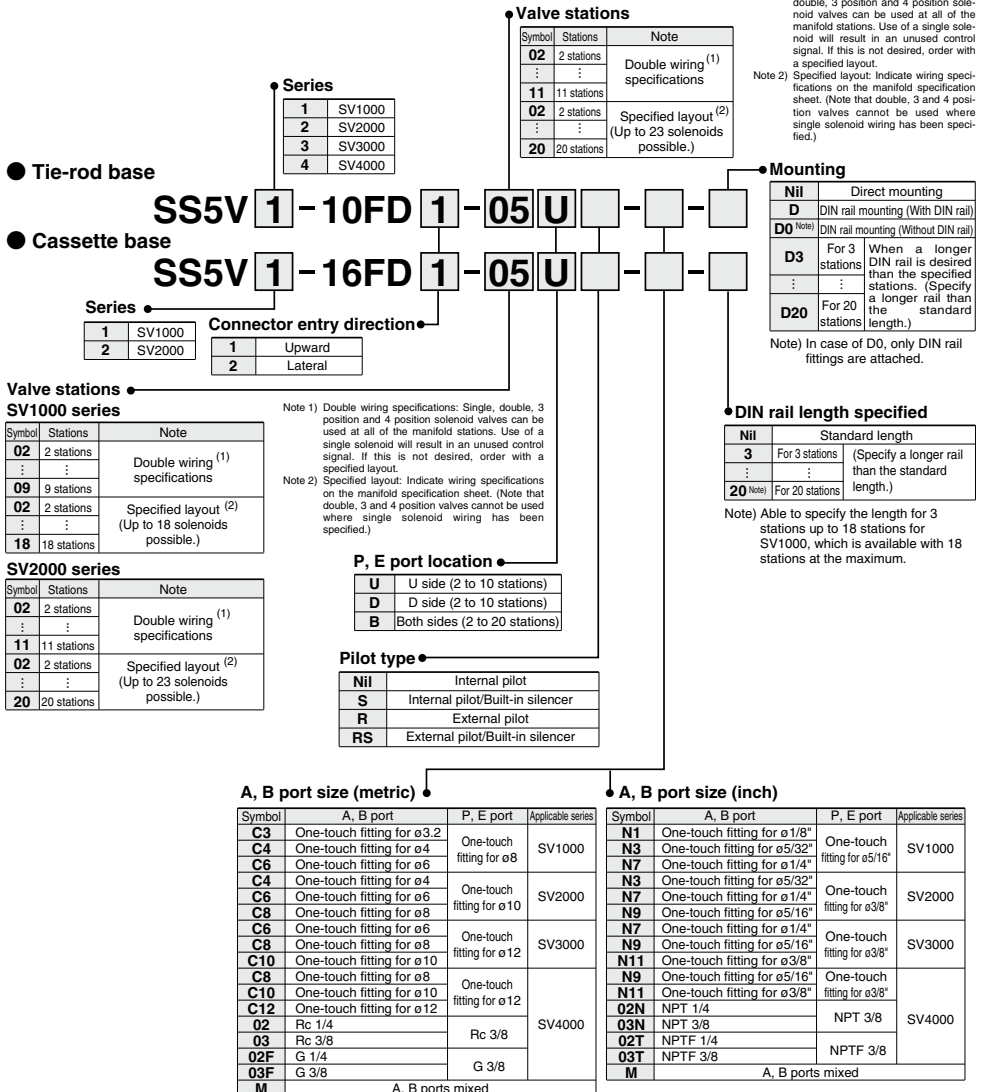

* In the case of mixed specifications (M), indicate separately on the manifold specification sheet.

* Port sizes of X, PE port for external pilot specifications (R, RS) are ø4 (metric), ø5/32" (inch) for SV1000/2000 and ø6 (metric) and ø1/4" (inch) for SV3000/4000.

How to Order Manifold Assembly

Ordering example (SV1000)

Manifold
SS5V1-16FD1-06B-C6 (1 set)

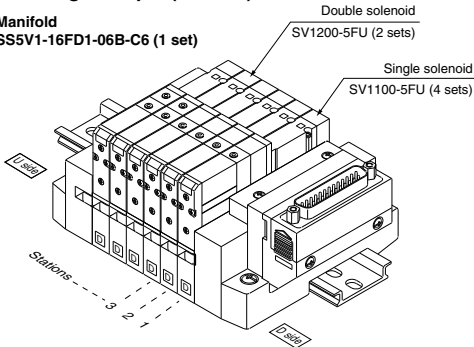

SS5V1-16FD1-06B-C6.....1 set (Manifold part no.)
* SV1100-5FU.....4 sets (Single solenoid part no.)
* SV1200-5FU.....2 sets (Double solenoid part no.)

How to Order Solenoid Valves

SV 1 1 0 0 - 5 F - [] - []

Series

| | |
|---|--------|
| 1 | SV1000 |
| 2 | SV2000 |
| 3 | SV3000 |
| 4 | SV4000 |

Type of actuation

| | |
|---|---|
| 1 | 2 position single |
| 2 | 2 position double |
| 3 | 3 position closed center |
| 4 | 3 position exhaust center |
| 5 | 3 position pressure center |
| A | 4 position dual 3 port valve: N.C./N.C. |
| B | 4 position dual 3 port valve: N.O./N.O. |
| C | 4 position dual 3 port valve: N.C./N.O. |

* 4 position dual 3 port valves are applicable to the SV1000 and SV2000 series only.

Pilot type

| | |
|-----|----------------|
| Nil | Internal pilot |
| R | External pilot |

* External pilot specifications is not available for 4 position dual 3 port valves.

Note) Available with manifold block for station additions. Refer to pages 113 and 119.

Made to Order

| | |
|-----|--|
| Nil | — |
| X90 | Main valve fluororubber (Refer to page 134.) |

Manual override

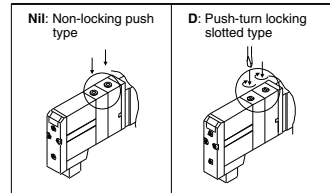

Light/Surge voltage suppressor

| | |
|---|-------------------------------------|
| U | With light/surge voltage suppressor |
| R | With surge voltage suppressor |

Rated voltage

| | |
|---|--------|
| 5 | 24 VDC |
| 6 | 12 VDC |

Back pressure check valve

| | |
|-----|----------|
| Nil | None |
| K | Built-in |

* Built-in back pressure check valve type is applicable to the SV1000 series only.

* Back pressure check valve is not available for 3 position valve.

Note) Refer to Specific Product Precautions 2 on page 136.

Manifold Electrical Wiring

10F/16F D-sub Connector Type (25 pins)

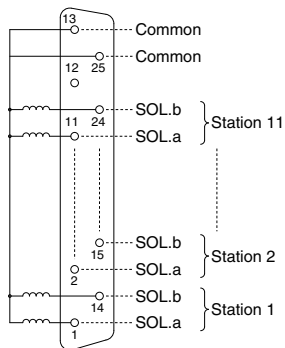

- This circuit has double wiring specifications for up to 11 stations. Since the usable number of solenoids differs depending on the manifold type, refer to the table below.
In the case of single solenoids, connect to SOL.A. Furthermore, when wiring is specified on the manifold specification sheet, connections are made without skipping any connectors, and signals A for single and A, B for double are in order 1 → 14 → 2 → 15, etc.
- Stations are counted from D side (connector side) as the 1st.
- Since solenoid valves do not have polarity, either the +COM or -COM can be used.

Usable No. of Solenoids

| Model | Max. no. of solenoids | |
|--|-----------------------|----|
| Tie-rod base type 10 SV1000 to SV4000 | 23 | |
| Cassette base type 16 | SV1000 | 18 |
| | SV2000 | 23 |

Dimensions: SV2000 Series for D-sub Connector

● Cassette base manifold: SS5V2-16FD₂ - Stations $\frac{U}{D}$ (S, R, RS) C4, N3 C5, N7 C8, N9

- When P, E port outlets are indicated on the U side or D side, the P, E ports on the opposite side are plugged.
- External pilot port positions and silencer discharge port positions are the same as P, E port outlet positions.

With External Pilot Specifications

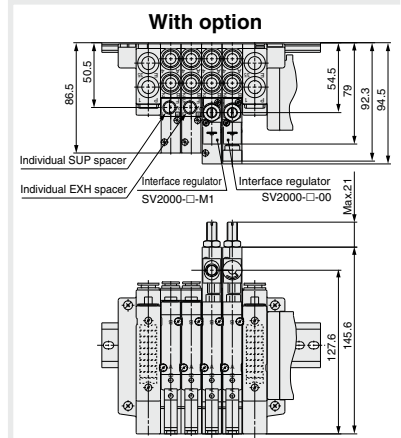
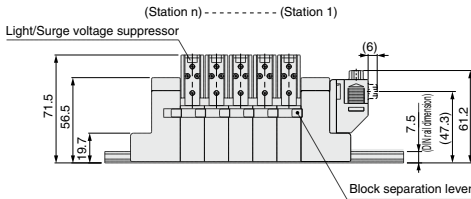
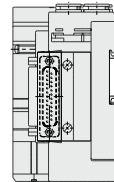
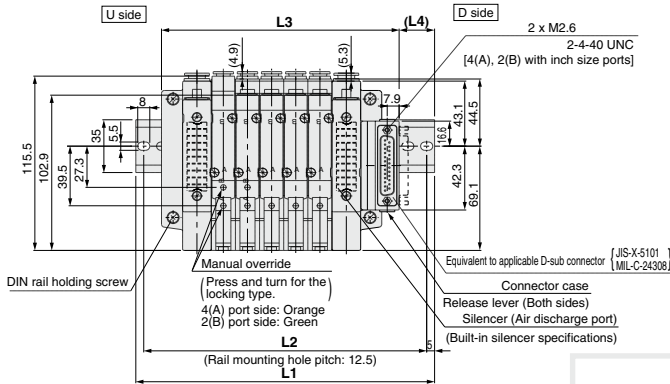
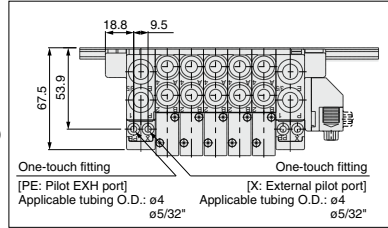
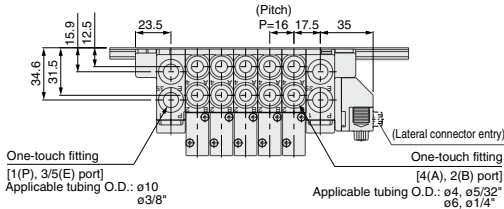

L Dimension

| n | 2 | 3 | 4 | 5 | 6 | 7 | 8 | 9 | 10 | 11 | 12 | 13 | 14 | 15 | 16 | 17 | 18 | 19 | 20 |
|----|-------|-------|-------|-------|-------|-------|-------|-------|-------|-------|-------|-------|-------|-------|-------|-------|-------|-------|-------|
| L1 | 148 | 160.5 | 173 | 198 | 210.5 | 223 | 235.5 | 260.5 | 273 | 285.5 | 310.5 | 323 | 335.5 | 348 | 373 | 385.5 | 398 | 423 | 435.5 |
| L2 | 137.5 | 150 | 162.5 | 187.5 | 200 | 212.5 | 225 | 250 | 262.5 | 275 | 300 | 312.5 | 325 | 337.5 | 362.5 | 375 | 387.5 | 412.5 | 425 |
| L3 | 109.5 | 125.5 | 141.5 | 157.5 | 173.5 | 189.5 | 205.5 | 221.5 | 237.5 | 253.5 | 269.5 | 285.5 | 301.5 | 317.5 | 333.5 | 349.5 | 365.5 | 381.5 | 397.5 |
| L4 | 22.5 | 20.5 | 19 | 23.5 | 21.5 | 20 | 18 | 22.5 | 21 | 19 | 23.5 | 22 | 20 | 18.5 | 23 | 21 | 19.5 | 24 | 22 |

SV Series

Dimensions: SV2000 Series for D-sub Connector

● Tie-rod base manifold: SS5V2-10FD₂¹ = $\left[\begin{matrix} \text{Stations} \\ \text{D} \end{matrix} \right] \begin{matrix} \text{U} \\ \text{B} \end{matrix} (\text{S, R, RS}) - \begin{matrix} \text{C4, N3} \\ \text{C5, N7} \\ \text{C5, N9} \end{matrix} (-\text{D})$

- When P, E port outlets are indicated on the U side or D side, the P, E ports on the opposite side are plugged.
- External pilot port positions and silencer discharge port positions are the same as P, E port outlet positions.

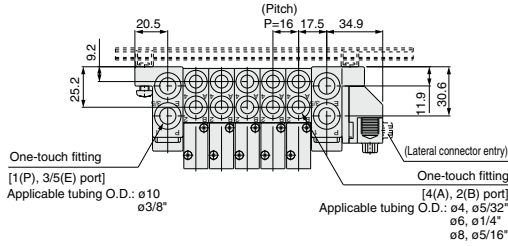

With External Pilot Specifications

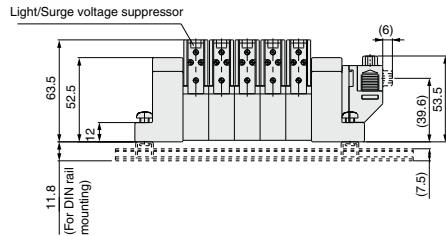
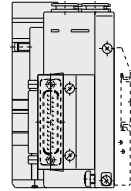
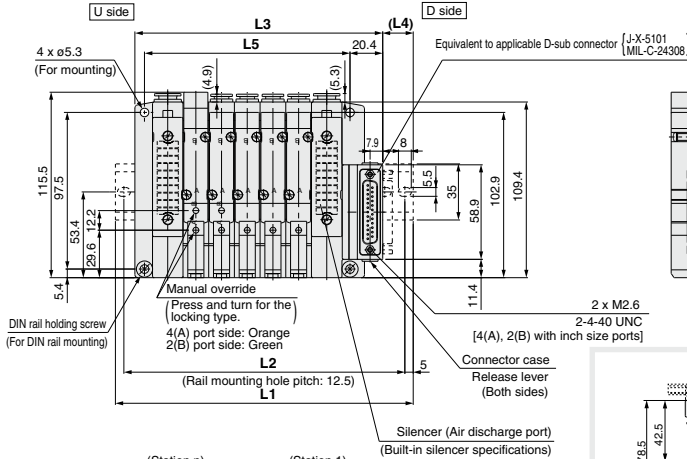
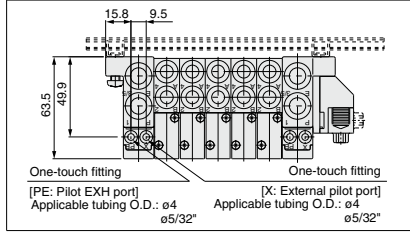

With option

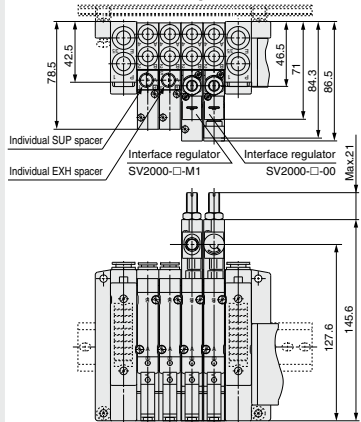

L Dimension

| n | 2 | 3 | 4 | 5 | 6 | 7 | 8 | 9 | 10 | 11 | 12 | 13 | 14 | 15 | 16 | 17 | 18 | 19 | 20 |
|----|-------|-------|-------|-------|-------|-------|-------|-------|-------|-------|-------|-------|-------|-------|-------|-------|-------|-------|-------|
| L1 | 135.5 | 160.5 | 173 | 185.5 | 210.5 | 223 | 235.5 | 248 | 273 | 285.5 | 298 | 323 | 335.5 | 348 | 360.5 | 385.5 | 398 | 410.5 | 435.5 |
| L2 | 125 | 150 | 162.5 | 175 | 200 | 212.5 | 225 | 237.5 | 262.5 | 275 | 287.5 | 312.5 | 325 | 337.5 | 350 | 375 | 387.5 | 400 | 425 |
| L3 | 106.4 | 122.4 | 138.4 | 154.4 | 170.4 | 186.4 | 202.4 | 218.4 | 234.4 | 250.4 | 266.4 | 282.4 | 298.4 | 314.4 | 330.4 | 346.4 | 362.4 | 378.4 | 394.4 |
| L4 | 17.5 | 22 | 20.5 | 18.5 | 23 | 21.5 | 19.5 | 18 | 23.4 | 20.5 | 19 | 23.5 | 21.5 | 20 | 18 | 22.5 | 21 | 19 | 23.5 |
| L5 | 80 | 96 | 112 | 128 | 144 | 160 | 176 | 192 | 208 | 224 | 240 | 256 | 272 | 288 | 304 | 320 | 336 | 352 | 368 |

Dimensions: SV3000 Series for D-sub Connector

● Tie-rod base manifold: SS5V3-10FD₂ $\left[\begin{matrix} \text{Stations} \\ \text{U} \\ \text{D} \end{matrix} \right] (\text{S, R, RS}) - \begin{matrix} \text{C6, N7} \\ \text{C8, N9} \\ \text{C10, N11} \end{matrix} (-\text{D})$

- When P, E port outlets are indicated on the U side or D side, the P, E ports on the opposite side are plugged.
- External pilot port positions and silencer discharge port positions are the same as P, E port outlet positions.

With External Pilot Specifications

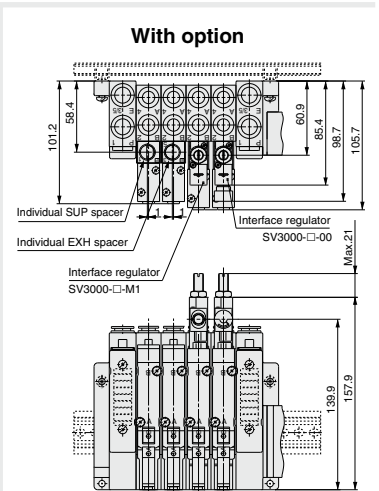
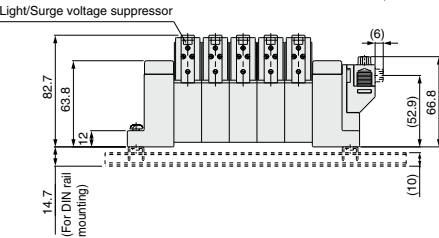
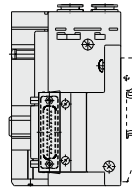
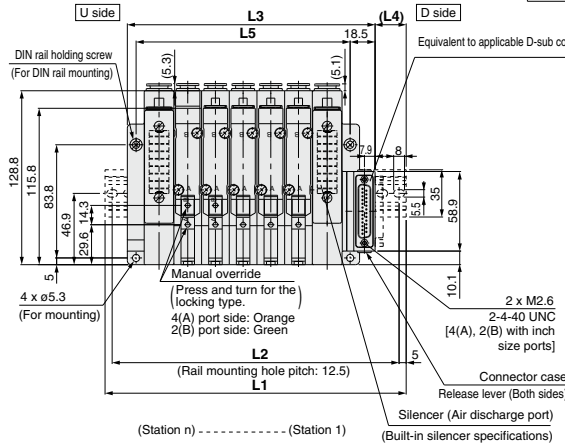
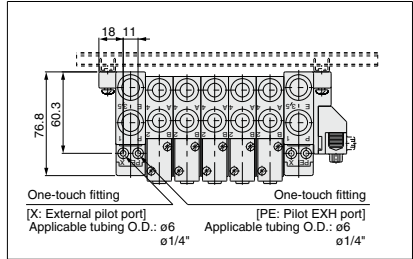
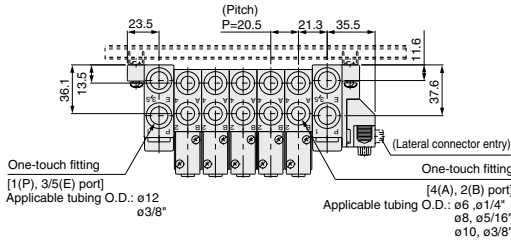

L Dimension

| n | 1 | 2 | 3 | 4 | 5 | 6 | 7 | 8 | 9 | 10 | 11 | 12 | 13 | 14 | 15 | 16 | 17 | 18 | 19 | 20 |
|----|-------|-------|-------|-------|-------|-------|-------|-------|-------|-------|-------|-------|-------|-------|-------|-------|-------|-------|-------|----|
| L1 | 160.5 | 173 | 198 | 223 | 235.5 | 260.5 | 285.5 | 298 | 323 | 348 | 360.5 | 385.5 | 398 | 423 | 448 | 460.5 | 485.5 | 510.5 | 523 | |
| L2 | 150 | 162.5 | 187.5 | 212.5 | 225 | 250 | 275 | 287.5 | 312.5 | 337.5 | 350 | 375 | 387.5 | 412.5 | 437.5 | 450 | 475 | 500 | 512.5 | |
| L3 | 122 | 142.5 | 163 | 183.5 | 204 | 224.5 | 245 | 265.5 | 286 | 306.5 | 327 | 347.5 | 368 | 388.5 | 409 | 429.5 | 450 | 470.5 | 491 | |
| L4 | 22.5 | 18.5 | 20.5 | 23 | 19 | 21 | 23.5 | 19.5 | 21.5 | 24 | 20 | 22 | 18 | 20.5 | 22.5 | 18.5 | 21 | 23 | 19 | |
| L5 | 97 | 117.5 | 138 | 158.5 | 179 | 199.5 | 220 | 240.5 | 261 | 281.5 | 302 | 322.5 | 343 | 363.5 | 384 | 404.5 | 425 | 445.5 | 466 | |

n: Stations

Flat Ribbon Cable Connector

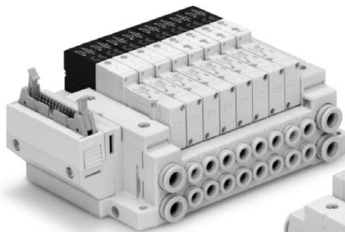

Tie-rod base

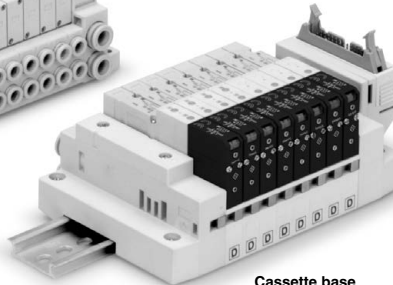

Cassette base

Applicable series

Cassette base manifold
SV1000/SV2000

Tie-rod base manifold
SV1000/SV2000/SV3000/SV4000

- Number of connectors: 26, 20, 10 pins
- With strain relief
- Conforming to MIL-C-83503

Flat Ribbon Cable Connector

SV Series



How to Order Manifold

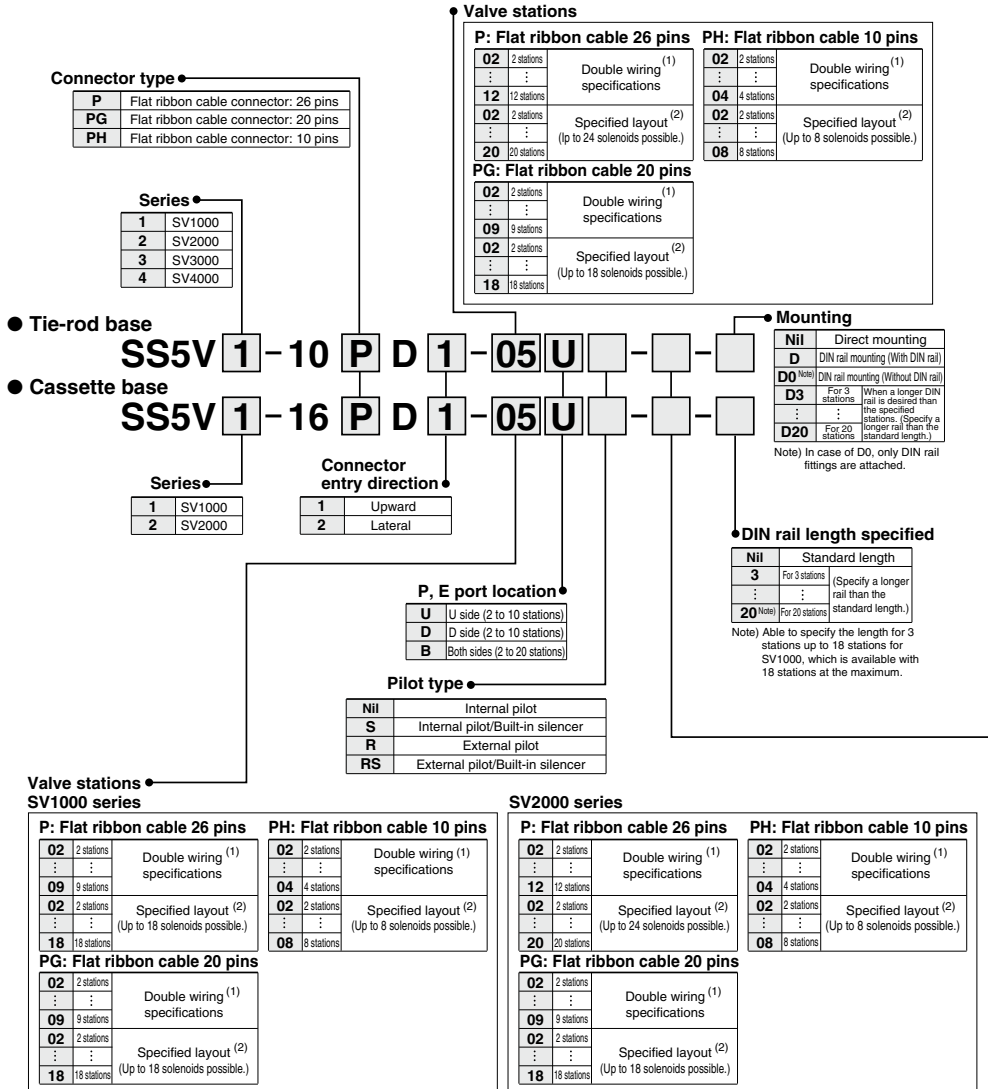

Note 1) Double wiring specifications: Single, double, 3 and 4 position solenoid valves can be used on all manifold stations. Use of a single solenoid will result in an unused control signal. If this is not desired, order with a specified layout.

Note 2) Specified layout: Indicate wiring specifications on a manifold specification sheet. (Note that double, 3 and 4 position valves cannot be used where single solenoid wiring has been specified.)

How to Order Valve Manifold Assembly

Ordering example (SV1000)

Manifold

SS5V1-16PD1-06B-C6 (1 set)

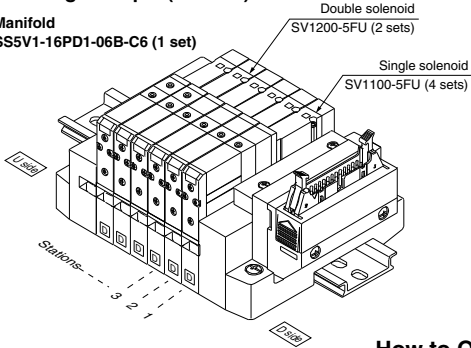

SS5V1-16PD1-06B-C6.....1 set (manifold part no.)
 * SV1100-5FU.....4 sets (Single solenoid part no.)
 * SV1200-5FU.....2 sets (Double solenoid part no.)

How to Order Valve

SV 1 1 0 0 - 5 F

Series ●

| | |
|---|--------|
| 1 | SV1000 |
| 2 | SV2000 |
| 3 | SV3000 |
| 4 | SV4000 |

Type of actuation ●

| | |
|---|---|
| 1 | 2 position single |
| 2 | 2 position double |
| 3 | 3 position closed center |
| 4 | 3 position exhaust center |
| 5 | 3 position pressure center |
| A | 4 position dual 3 port valve: N.C./N.C. |
| B | 4 position dual 3 port valve: N.O./N.O. |
| C | 4 position dual 3 port valve: N.C./N.O. |

* 4 position dual 3 port valves are applicable to the SV1000 and SV2000 series only.

Pilot type ●

| | |
|-----|----------------|
| Nil | Internal pilot |
| R | External pilot |

* External pilot specifications is not available for 4 position dual 3 port valves.

Rated voltage

| | |
|---|--------|
| 5 | 24 VDC |
| 6 | 12 VDC |

Back pressure check valve

| | |
|-----|----------|
| Nil | None |
| K | Built-in |

* Built-in back pressure check valve type is applicable to the SV1000 series only.
 * Back pressure check valve is not available for 3 position valve.

Note) Refer to Specific Product Precautions 2 on page 136.

Note) []

Note) Available with manifold block for station additions. Refer to pages 113 and 119.

Made to Order ●

| | |
|-----|--|
| Nil | — |
| X90 | Main valve fluororubber (Refer to page 134.) |

Manual override

Nil: Non-locking push type

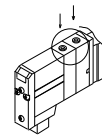

D: Push-turn locking slotted type

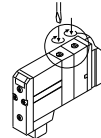

Light/Surge voltage suppressor

| | |
|---|-------------------------------------|
| U | With light/surge voltage suppressor |
| R | With surge voltage suppressor |

A, B port size (Metric)

| Symbol | A, B port | P, E port | Applicable series |
|--------|----------------------------|---------------------------|-------------------|
| C3 | One-touch fitting for ø3.2 | One-touch fitting for ø8 | SV1000 |
| C4 | One-touch fitting for ø4 | | |
| C6 | One-touch fitting for ø6 | One-touch fitting for ø10 | SV2000 |
| C4 | One-touch fitting for ø4 | | |
| C6 | One-touch fitting for ø6 | One-touch fitting for ø12 | SV3000 |
| C8 | One-touch fitting for ø8 | | |
| C10 | One-touch fitting for ø10 | One-touch fitting for ø12 | SV4000 |
| C12 | One-touch fitting for ø12 | | |
| 02 | Rc 1/4 | Rc 3/8 | |
| 03 | Rc 3/8 | | |
| 02F | G 1/4 | G 3/8 | |
| 03F | G 3/8 | | |
| M | A, B ports mixed | | |

A, B port size (Inch)

| Symbol | A, B port | P, E port | Applicable series |
|--------|------------------------------|------------------------------|-------------------|
| N1 | One-touch fitting for ø1/8" | One-touch fitting for ø5/16" | SV1000 |
| N3 | One-touch fitting for ø5/32" | | |
| N7 | One-touch fitting for ø1/4" | One-touch fitting for ø3/8" | SV2000 |
| N3 | One-touch fitting for ø5/32" | | |
| N7 | One-touch fitting for ø1/4" | One-touch fitting for ø3/8" | SV3000 |
| N9 | One-touch fitting for ø5/16" | | |
| N7 | One-touch fitting for ø1/4" | One-touch fitting for ø3/8" | SV4000 |
| N9 | One-touch fitting for ø5/16" | | |
| N11 | One-touch fitting for ø3/8" | One-touch fitting for ø3/8" | |
| N9 | One-touch fitting for ø5/16" | | |
| N11 | One-touch fitting for ø3/8" | NPT 3/8 | |
| 02N | NPT 1/4 | | |
| 03N | NPT 3/8 | NPTF 3/8 | |
| 02T | NPTF 1/4 | | |
| 03T | NPTF 3/8 | | |
| M | A, B ports mixed | | |

* In the case of mixed specifications (M), indicate separately on the manifold specification sheet.

* Port sizes of X, PE port for external pilot specification (R, RS) are ø4 (metric), ø5/32" (inch) for SV1000/2000 and ø6 (metric) and ø1/4" (inch) for SV3000/4000.

Manifold Electrical Wiring

10P/16P Flat Ribbon Cable Type (26 pins)

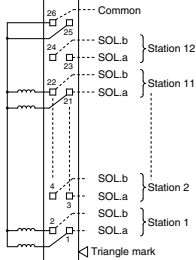

- This circuit has double wiring specifications for up to 12 stations. Since the usable number of solenoids differs depending on the manifold type, refer to the table below. In the case of single solenoids, connect to SOL. A. Furthermore, when wiring is specified on a manifold specification sheet, connections are made without skipping any connectors, and connectors are made without skipping any connectors, and signals A for single and A, B for double are in order 1 → 2 → 3 → 4, etc.
- Stations are counted from D side (connector side) as the 1st one.
- Since terminal numbers are not indicated on the flat cable, use the triangle mark as a reference for wiring.
- Since solenoid valves do not have polarity, either the +COM or -COM can be used.

Usable No. of Solenoids

| Model | | Max. no. of solenoids |
|-----------------------|------------------|-----------------------|
| Tie-rod base type 10 | SV1000 to SV4000 | 24 |
| | SV1000 to SV2000 | 18 |
| Cassette base type 16 | SV1000 to SV2000 | 24 |

10PG/16PG Flat Ribbon Cable Type (20 pins)

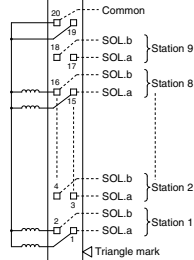

- This circuit has double wiring specifications for up to 9 stations. Since the usable number of solenoids differs depending on the manifold type, refer to the table below. In the case of single solenoids, connect to SOL. A. Furthermore, when wiring is specified on a manifold specification sheet, connections are made without skipping any connectors, and connectors are made without skipping any connectors, and signals A for single and A, B for double are in order 1 → 2 → 3 → 4, etc.
- Stations are counted from D side (connector side) as the 1st one.
- Since terminal numbers are not indicated on the flat cable, use the triangle mark as a reference for wiring.
- Since solenoid valves do not have polarity, either the +COM or -COM can be used.

Usable No. of Solenoids

| Model | | Max. no. of solenoids |
|----------------------|------------------|-----------------------|
| Tie-rod base type 10 | SV1000 to SV4000 | 18 |
| | SV1000 to SV2000 | 18 |

10PH/16PH Flat Ribbon Cable Type (10 pins)

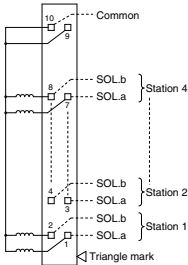

- This circuit has double wiring specifications for up to 4 stations. Since the usable number of solenoids differs depending on the manifold type, refer to the table below. In the case of single solenoids, connect to SOL. A. Furthermore, when wiring is specified on a manifold specification sheet, connections are made without skipping any connectors, and connectors are made without skipping any connectors, and signals A for single and A, B for double are in order 1 → 2 → 3 → 4, etc.
- Stations are counted from D side (connector side) as the 1st one.
- Since terminal numbers are not indicated on the flat cable, use the triangle mark as a reference for wiring.
- Since solenoid valves do not have polarity, either the +COM or -COM can be used.

Usable No. of Solenoids

| Model | | Max. no. of solenoids |
|----------------------|------------------|-----------------------|
| Tie-rod base type 10 | SV1000 to SV4000 | 8 |
| | SV1000 to SV2000 | 8 |

Dimensions: SV1000 Series for Flat Ribbon Cable

● Cassette base manifold : **SS5V1-16** ^P PG ^D D₂ - [Stations] ^U B (S, R, RS) ^{C3, N1} ^{C4, N3} ^{C6, N7}

- When P, E port outlets are indicated on the U side or D side, the P, E ports on the opposite side are plugged.
- External pilot port positions and silencer discharge port positions are the same as P, E port outlet positions.

With External Pilot Specifications

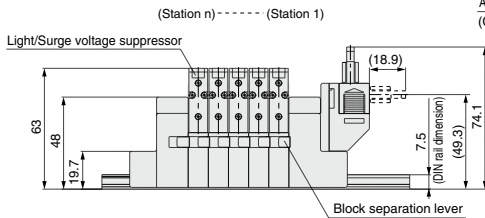
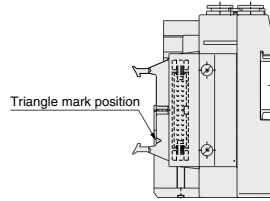
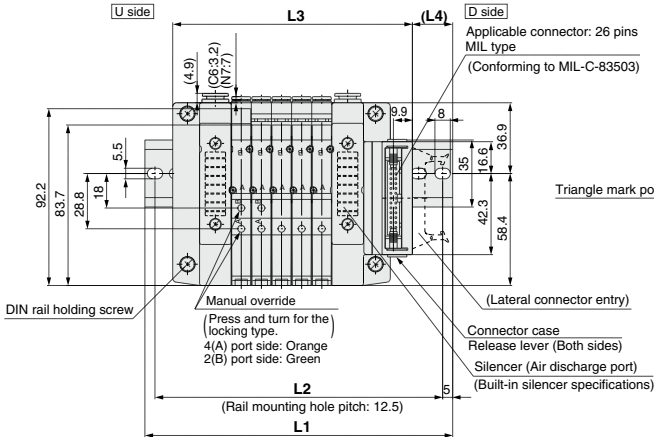
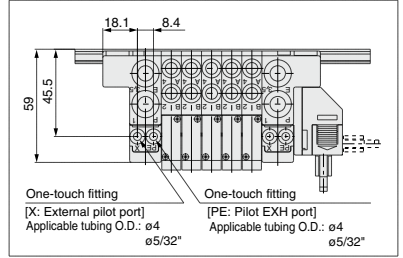
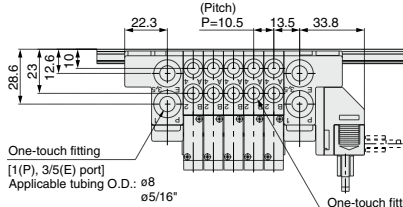

Applicable connector: 20 pins MIL type (Conforming to MIL-C-83503)

Applicable connector: 10 pins MIL type (Conforming to MIL-C-83503)

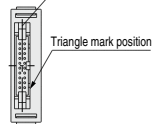

16PG (20 pins)

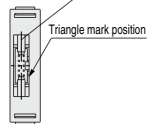

16PH (10 pins)

Refer to page 93 (compliant for D-sub connector) for dimensions with interface regulator and individual SUP/EXH spacer.

L Dimension

| | n : Stations | | | | | | | | | | | | | | | | |
|----|--------------|-------|-------|-------|-------|-------|-------|-------|-------|-------|-------|-------|-------|-------|-------|-------|-------|
| n | 2 | 3 | 4 | 5 | 6 | 7 | 8 | 9 | 10 | 11 | 12 | 13 | 14 | 15 | 16 | 17 | 18 |
| L1 | 135.5 | 135.5 | 148 | 160.5 | 173 | 185.5 | 198 | 198 | 210.5 | 223 | 235.5 | 248 | 260.5 | 260.5 | 273 | 285.5 | 298 |
| L2 | 125 | 125 | 137.5 | 150 | 162.5 | 175 | 187.5 | 187.5 | 200 | 212.5 | 225 | 237.5 | 250 | 250 | 262.5 | 275 | 287.5 |
| L3 | 93.5 | 104 | 114.5 | 125 | 135.5 | 146 | 156.5 | 167 | 177.5 | 188 | 198.5 | 209 | 219.5 | 230 | 240.5 | 251 | 261.5 |
| L4 | 24.5 | 19 | 20 | 21 | 22 | 23 | 24 | 19 | 20 | 21 | 22 | 23 | 24 | 18.5 | 19.5 | 20.5 | 21.5 |

SV Series

Dimensions: SV2000 Series for Flat Ribbon Cable

● Cassette base manifold : SS5V2-16 ^P _{PH} D₂ - [Stations] _B (S, R, RS) ^{C4, N3} _{C6, N7} ^{C8, N9}

- When P, E port outlets are indicated on the U side or D side, the P, E ports on the opposite side are plugged.
- External pilot port positions and silencer discharge port positions are the same as P, E port outlet positions.

With External Pilot Specifications

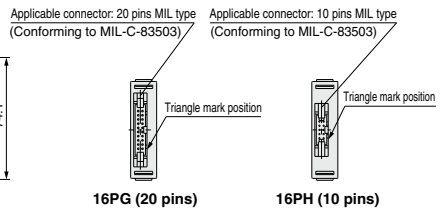
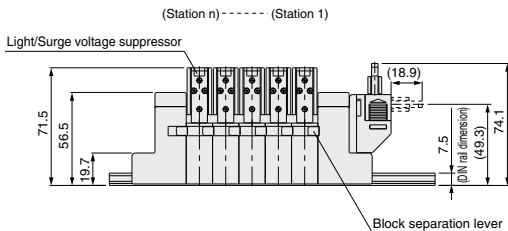
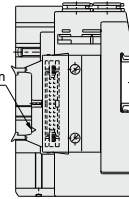
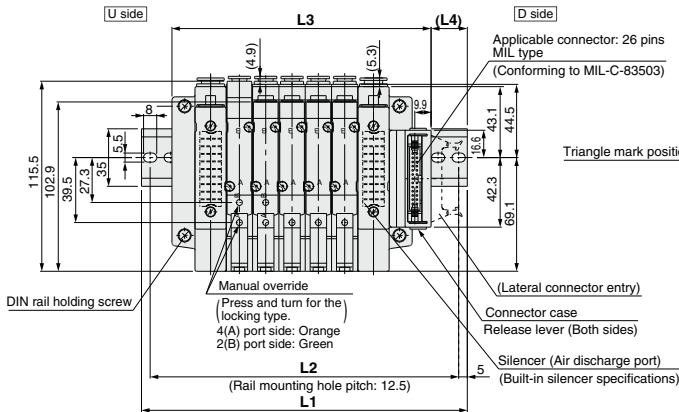
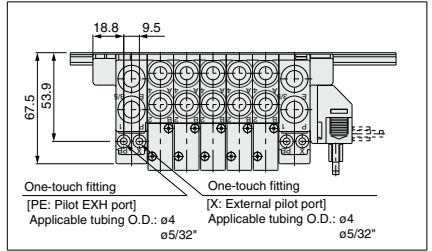
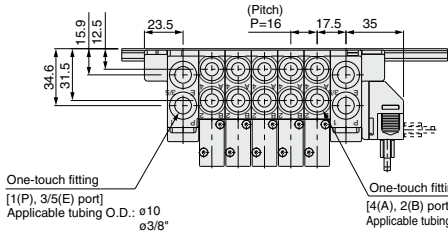

Refer to page 93 (compliant for D-sub connector) for dimensions with interface regulator and individual SUP/EXH spacer.

L Dimension

| n | 2 | 3 | 4 | 5 | 6 | 7 | 8 | 9 | 10 | 11 | 12 | 13 | 14 | 15 | 16 | 17 | 18 | 19 | 20 |
|----|-------|-------|-------|-------|-------|-------|-------|-------|-------|-------|-------|-------|-------|-------|-------|-------|-------|-------|-------|
| L1 | 148 | 160.5 | 173 | 198 | 210.5 | 223 | 235.5 | 260.5 | 273 | 285.5 | 310.5 | 323 | 335.5 | 348 | 373 | 385.5 | 398 | 423 | 435.5 |
| L2 | 137.5 | 150 | 162.5 | 187.5 | 200 | 212.5 | 225 | 250 | 262.5 | 275 | 300 | 312.5 | 325 | 337.5 | 362.5 | 375 | 387.5 | 412.5 | 425 |
| L3 | 109.5 | 125.5 | 141.5 | 157.5 | 173.5 | 189.5 | 205.5 | 221.5 | 237.5 | 253.5 | 269.5 | 285.5 | 301.5 | 317.5 | 333.5 | 349.5 | 365.5 | 381.5 | 397.5 |
| L4 | 22.5 | 21 | 19 | 23.5 | 22 | 20 | 18.5 | 23 | 21 | 19.5 | 24 | 22 | 20.5 | 18.5 | 23 | 21.5 | 19.5 | 24 | 22.5 |

Dimensions: SV1000 Series for Flat Ribbon Cable

● Tie-rod base manifold : SS5V1-10^P_{PH} D₂ - (Stations)^U_B (S, R, RS) - C_{3, N1}_{C6, N7} (-D)

- When P, E port outlets are indicated on the U side or D side, the P, E ports on the opposite side are plugged.
- External pilot port positions and silencer discharge port positions are the same as P, E port outlet positions.

With External Pilot Specifications

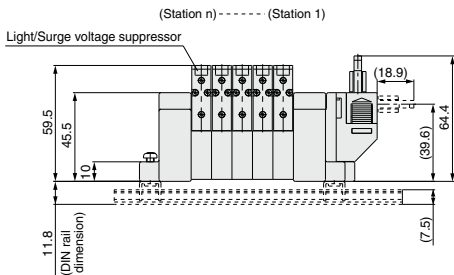
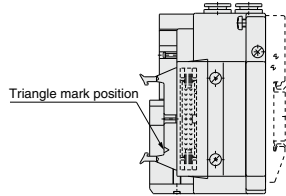
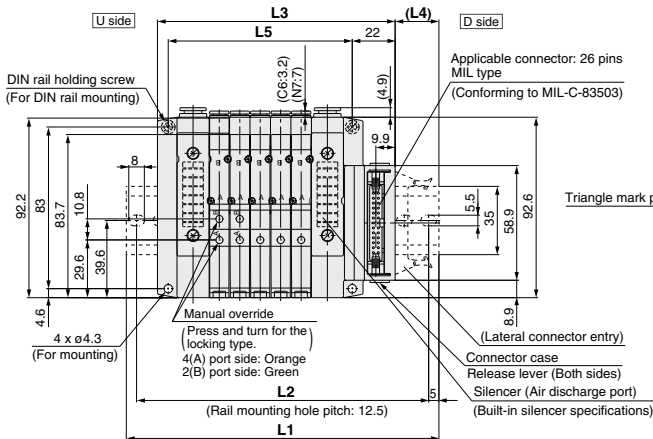
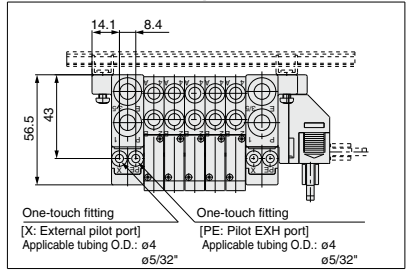
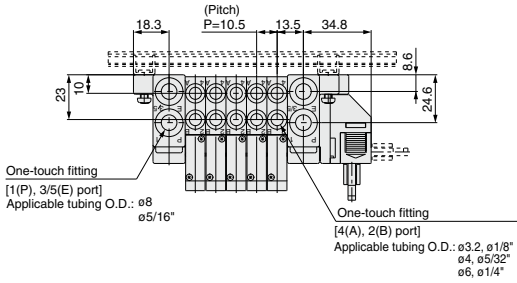

Applicable connector: 20 pins MIL type (Conforming to MIL-C-83503) Applicable connector: 10 pins MIL type (Conforming to MIL-C-83503)

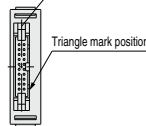

10PG (20 pins)

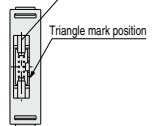

10PH (10 pins)

Refer to page 93 (compliant for D-sub connector) for dimensions with interface regulator and individual SUP/EXH spacer.

L Dimension

| | n : Stations | | | | | | | | | | | | | | | | | | | |
|----------------|--------------|-------|-------|-------|-------|-------|-------|-------|-------|-------|-------|-------|-------|-------|-------|-------|-------|-------|-------|--|
| L _n | 2 | 3 | 4 | 5 | 6 | 7 | 8 | 9 | 10 | 11 | 12 | 13 | 14 | 15 | 16 | 17 | 18 | 19 | 20 | |
| L1 | 123 | 135.5 | 148 | 160.5 | 173 | 173 | 185.5 | 198 | 210.5 | 223 | 235.5 | 248 | 248 | 260.5 | 273 | 285.5 | 298 | 310.5 | 310.5 | |
| L2 | 112.5 | 125 | 137.5 | 150 | 162.5 | 162.5 | 175 | 187.5 | 200 | 212.5 | 225 | 237.5 | 237.5 | 250 | 262.5 | 275 | 287.5 | 300 | 300 | |
| L3 | 90.5 | 101 | 111.5 | 122 | 132.5 | 143 | 153.5 | 164 | 174.5 | 185 | 195.5 | 206 | 216.5 | 227 | 237.5 | 248 | 258.5 | 269 | 279.5 | |
| L4 | 19.5 | 20.5 | 21.5 | 22.5 | 23.5 | 18.5 | 19.5 | 20.5 | 21.5 | 22.5 | 23.5 | 24.5 | 19 | 20 | 21 | 22 | 23 | 24 | 19 | |
| L5 | 63 | 73.5 | 84 | 94.5 | 105 | 115.5 | 126 | 136.5 | 147 | 157.5 | 168 | 178.5 | 189 | 199.5 | 210 | 220.5 | 231 | 241.5 | 252 | |

SV Series

Dimensions: SV2000 Series for Flat Ribbon Cable

● Tie-rod base manifold : SS5V2-10 ^P PG D₂ - [Stations] _B (S, R, RS) ^{C4, N3} - C6, N7 / (-D)

- When P, E port outlets are indicated on the U side or D side, the P, E ports on the opposite side are plugged.
- External pilot port positions and silencer discharge port positions are the same as P, E port outlet positions.

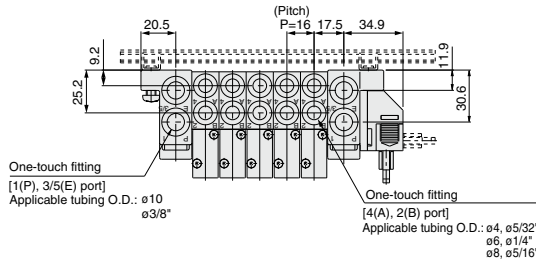

With External Pilot Specifications

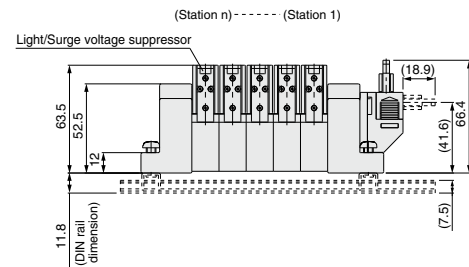
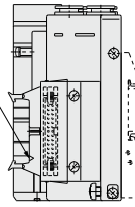
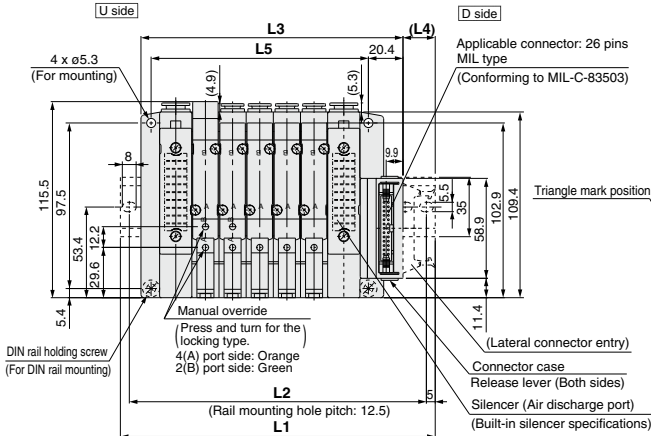
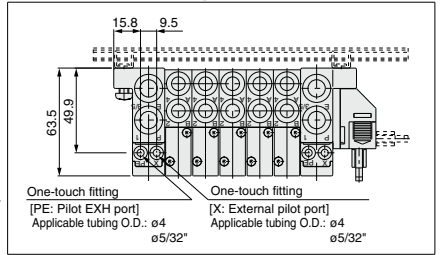

Applicable connector: 20 pins MIL type (Conforming to MIL-C-83503)

Applicable connector: 10 pins MIL type (Conforming to MIL-C-83503)

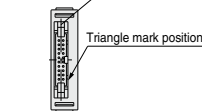

10PG (20 pins)

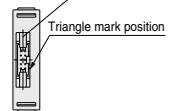

10PH (10 pins)

Refer to page 96 (compliant for D-sub connector) for dimensions with interface regulator and individual SUP/EXH spacer.

L Dimension

| L | n : Stations | | | | | | | | | | | | | | | | | | | |
|----|--------------|-------|-------|-------|-------|-------|-------|-------|-------|-------|-------|-------|-------|-------|-------|-------|-------|-------|-------|----|
| | 1 | 2 | 3 | 4 | 5 | 6 | 7 | 8 | 9 | 10 | 11 | 12 | 13 | 14 | 15 | 16 | 17 | 18 | 19 | 20 |
| L1 | 148 | 160.5 | 173 | 185.5 | 210.5 | 223 | 235.5 | 248 | 273 | 285.5 | 298 | 323 | 335.5 | 348 | 360.5 | 385.5 | 398 | 410.5 | 435.5 | |
| L2 | 137.5 | 150 | 162.5 | 175 | 200 | 212.5 | 225 | 237.5 | 262.5 | 275 | 287.5 | 312.5 | 325 | 337.5 | 350 | 375 | 387.5 | 400 | 425 | |
| L3 | 106.4 | 122.4 | 138.4 | 154.4 | 170.4 | 186.4 | 202.4 | 218.4 | 234.4 | 250.4 | 266.4 | 282.4 | 298.4 | 314.4 | 330.4 | 346.4 | 362.4 | 378.4 | 394.4 | |
| L4 | 24 | 22.5 | 20.5 | 19 | 23.5 | 21.5 | 20 | 18 | 22.5 | 21 | 19 | 23.5 | 22 | 20 | 18.5 | 23 | 21 | 19.5 | 24 | |
| L5 | 80 | 96 | 112 | 128 | 144 | 160 | 176 | 192 | 208 | 224 | 240 | 256 | 272 | 288 | 304 | 320 | 336 | 352 | 368 | |

Dimensions: SV3000 Series for Flat Ribbon Cable

● Tie-rod base manifold : $SS5V3-10 \frac{P}{PH} \frac{D_2}{D_1} - [Stations] \frac{U}{B} (S, R, RS) \frac{C_6, N7}{C_8, N9} \frac{C_{10}, N_{11}}{(-)}$

- When P, E port outlets are indicated on the U side or D side, the P, E ports on the opposite side are plugged.
- External pilot port positions and silencer discharge port positions are the same as P, E port outlet positions.

With External Pilot Specifications

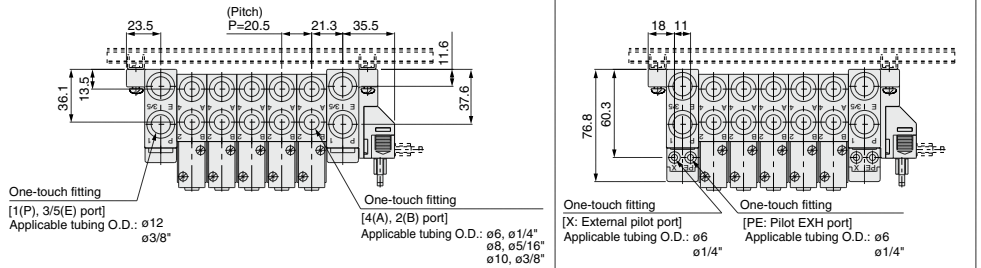

(Station n) ----- (Station 1)

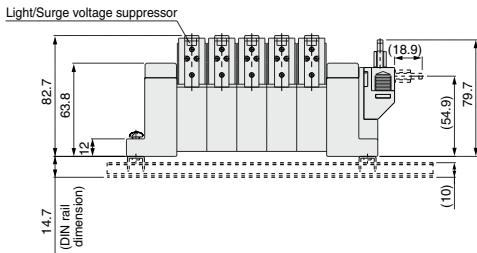

Applicable connector: 20 pins MIL type (Conforming to MIL-C-83503)

Applicable connector: 10 pins MIL type (Conforming to MIL-C-83503)

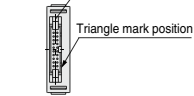

10PG (20 pins)

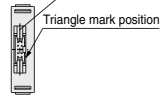

10PH (10 pins)

Refer to page 97 (compliant for D-sub connector) for dimensions with interface regulator and individual SUP/EXH spacer.

L Dimension

| | n : Stations | | | | | | | | | | | | | | | | | | | |
|----------------|--------------|-------|-------|-------|-------|-------|-------|-------|-------|-------|-------|-------|-------|-------|-------|-------|-------|-------|-------|----|
| L _n | 1 | 2 | 3 | 4 | 5 | 6 | 7 | 8 | 9 | 10 | 11 | 12 | 13 | 14 | 15 | 16 | 17 | 18 | 19 | 20 |
| L ₁ | 160.5 | 173 | 198 | 223 | 235.5 | 260.5 | 285.5 | 298 | 323 | 348 | 360.5 | 385.5 | 398 | 423 | 448 | 460.5 | 485.5 | 510.5 | 523 | |
| L ₂ | 150 | 162.5 | 187.5 | 212.5 | 225 | 250 | 275 | 287.5 | 312.5 | 337.5 | 350 | 375 | 387.5 | 412.5 | 437.5 | 450 | 475 | 500 | 512.5 | |
| L ₃ | 122 | 142.5 | 163 | 183.5 | 204 | 224.5 | 245 | 265.5 | 286 | 306.5 | 327 | 347.5 | 368 | 388.5 | 409 | 429.5 | 450 | 470.5 | 491 | |
| L ₄ | 22.5 | 18.5 | 21 | 23 | 19 | 21.5 | 23.5 | 19.5 | 22 | 24 | 20.5 | 22.5 | 18.5 | 20.5 | 23 | 19 | 21 | 23.5 | 19.5 | |
| L ₅ | 97 | 117.5 | 138 | 158.5 | 179 | 199.5 | 220 | 240.5 | 261 | 281.5 | 302 | 322.5 | 343 | 363.5 | 384 | 404.5 | 425 | 445.5 | 466 | |

SV Series

Dimensions: SV4000 Series for Flat Ribbon Cable

● Tie-rod base manifold : SS5V4-10^P_{PH} D₁^P - (Stations)_B (S, R, RS) 0₂^{CS}, 0₃^{CS}, N₈, C₁₀, N₁₁ (-D)

- When P, E port outlets are indicated on the U side or D side, the P, E ports on the opposite side are plugged.
- External pilot port positions and silencer discharge port positions are the same as P, E port outlet positions.

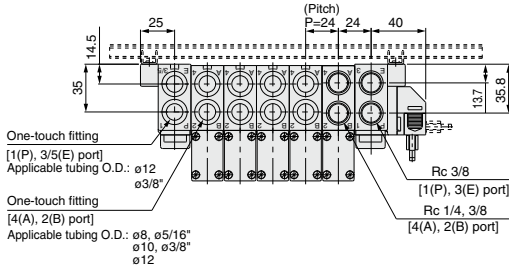

With External Pilot Specifications

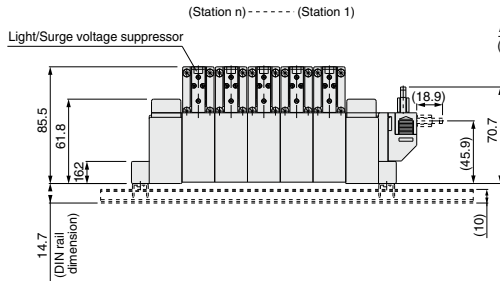
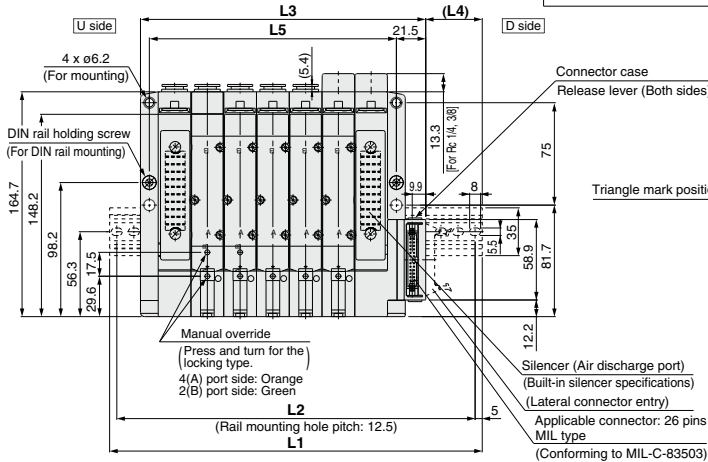
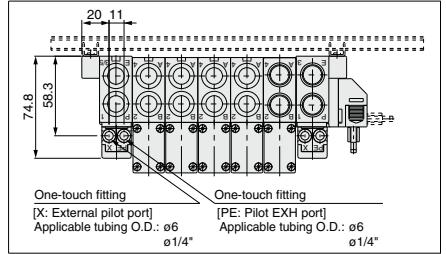

Applicable connector: 20 pins MIL type (Conforming to MIL-C-83503)

Applicable connector: 10 pins MIL type (Conforming to MIL-C-83503)

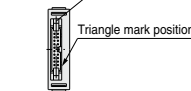

10PG (20 pins)

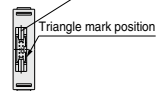

10PH (10 pins)

Refer to page 98 (compliant for D-sub connector) for dimensions with interface regulator and individual SUP/EXH spacer.

L Dimension

| n | 2 | 3 | 4 | 5 | 6 | 7 | 8 | 9 | 10 | 11 | 12 | 13 | 14 | 15 | 16 | 17 | 18 | 19 | 20 |
|----|-------|-------|-------|-------|-------|-------|-------|-------|-------|-------|-------|-------|-------|-------|-------|-------|-------|-------|-------|
| L1 | 185.5 | 210.5 | 235.5 | 260.5 | 285.5 | 310.5 | 335.5 | 348 | 373 | 398 | 423 | 448 | 473 | 498 | 523 | 548 | 573 | 598 | 623 |
| L2 | 175 | 200 | 225 | 250 | 275 | 300 | 325 | 337.5 | 362.5 | 387.5 | 412.5 | 437.5 | 462.5 | 487.5 | 512.5 | 537.5 | 562.5 | 587.5 | 612.5 |
| L3 | 137 | 161 | 185 | 209 | 233 | 257 | 281 | 305 | 329 | 353 | 377 | 401 | 425 | 449 | 473 | 497 | 521 | 545 | 569 |
| L4 | 31.5 | 31.5 | 31.5 | 31.5 | 31.5 | 31.5 | 31.5 | 31.5 | 31.5 | 31.5 | 31.5 | 31.5 | 31.5 | 31.5 | 31.5 | 31.5 | 31.5 | 31.5 | 31.5 |
| L5 | 109 | 133 | 157 | 181 | 205 | 229 | 253 | 277 | 301 | 325 | 349 | 373 | 397 | 421 | 445 | 469 | 493 | 517 | 541 |

n : Stations

Type 16: Cassette Base Manifold Exploded View

⚠ Caution

Mounting Screw Tightening Torques

M2: 0.15 N·m

M3: 0.6 N·m

M4: 1.4 N·m

Unless otherwise indicated, tighten mounting screws to the torques shown above.

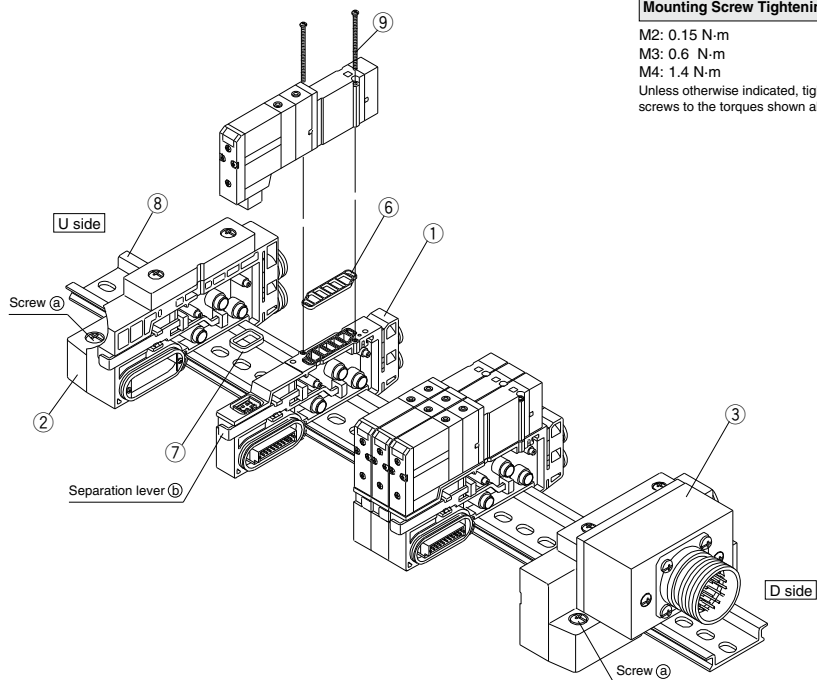

③ SUP/EXH block assembly

EX500 (Type 16SA2W)

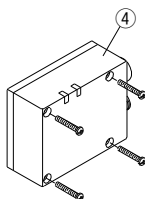
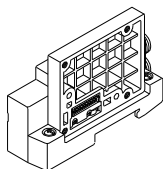

EX120 (Type 16S3□)

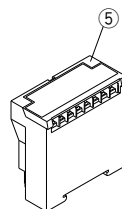
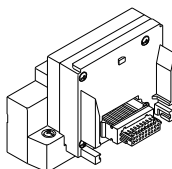

Circular connector (Type 16C)

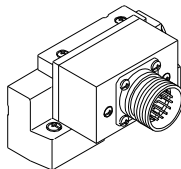

D-sub connector (Type 16F□)

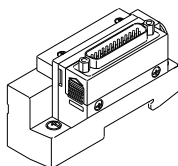

For Flat ribbon cable connector (Type 16P□)

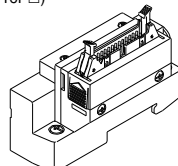

① **Manifold Block Assembly Part No.**

| Series | Wiring specifications | Manifold block assembly part no. | Note |
|--------|-----------------------|----------------------------------|---|
| SV1000 | Single | SV1000-50-3A-□□ | C3: With One-touch fitting for ø3.2 N1: One-touch fitting for ø1/8" C4: With One-touch fitting for ø4 N3: One-touch fitting for ø5/32" C6: With One-touch fitting for ø6 N7: One-touch fitting for ø1/4" (Gaskets ⑥ and ⑦ are included.) |
| | Double | SV1000-50-4A-□□ | |
| SV2000 | Single | SV2000-50-3A-□□ | C4: With One-touch fitting for ø4 N3: One-touch fitting for ø5/32" C6: With One-touch fitting for ø6 N7: One-touch fitting for ø1/4" C8: With One-touch fitting for ø8 N9: One-touch fitting for ø5/16" (Gaskets ⑥ and ⑦ are included.) |
| | Double | SV2000-50-4A-□□ | |

② **SUP/EXH end block assembly** SV □ 000 – 52U – 2 A □ – □

③ **SUP/EXH block assembly** SV □ 000 – 51D □ – □ A □ – □

| Series | |
|--------|--------|
| 1 | SV1000 |
| 2 | SV2000 |

Connector entry direction
(D-sub, flat types only)

| | |
|---|---------|
| 1 | Upward |
| 2 | Lateral |

SUP/EXH block assembly specifications

| | |
|----|---|
| 30 | For EX500 (decentralized serial) |
| 32 | For circular connector |
| 33 | D-sub connector |
| 34 | For flat ribbon cable connector (26 pins) |
| 35 | For flat ribbon cable connector (20 pins) |
| 36 | For flat ribbon cable connector (10 pins) |
| 38 | For EX120 (dedicated output serial) |

* Since EX500 and EX120 type SI units are not included, order them separately.

● **P, E port size**

| | | |
|------------------------|------------------------------|------------|
| C8 | One-touch fitting for ø8 | SV1000 |
| N9 | One-touch fitting for ø5/16" | |
| C10 | One-touch fitting for ø10 | SV2000 |
| N11 | One-touch fitting for ø3/8" | |
| 00 ^{Note 1)} | Plug | All series |
| 00U ^{Note 2)} | | |

Note 1) "00" (Plug) is not available for S, R and RS types.

Note 2) "00U" is available only for D-sub connectors and the lock bracket size is in inches.

● **Pilot specifications**

| | |
|-----|----------------------------------|
| NII | Internal pilot specifications |
| S | Internal pilot/Built-in silencer |
| R | External pilot specifications |
| RS | External pilot/Built-in silencer |

| No. | Description | Part no. | | Note |
|-----|------------------------------|-----------------------------|----------------------------|---|
| | | SV1000 | SV2000 | |
| ④ | EX500 series SI unit | EX500-S0001 | | |
| ⑤ | EX120 series SI unit | Refer to page 70. | | |
| ⑥ | Gasket | SX3000-57-4 | SX5000-57-6 | |
| ⑦ | Connector gasket | SX3000-146-2 | | |
| ⑧ | DIN rail | VZ1000-11-1-□ | | Refer to DIN rail dimension tables on page 123. |
| ⑨ | Round head combination screw | SX3000-22-2 (M2 x 24) | SV2000-21-1 (M3 x 30) | |
| | | Tightening torque: 0.16 N·m | Tightening torque: 0.8 N·m | |

Type 16: Cassette Base Manifold

How to increase manifold bases (Type 16)

- (1) Loosen the screws (a) (2 pcs. on one side) that hold the manifold base onto the DIN rail.
(When removing the manifold base from the DIN rail, loosen the holding screws at four locations.)
- (2) Using a flat head screwdriver, etc., pull the lever (b) forward on the manifold block assembly where a station is to be added, and disconnect the manifold block assemblies.
- (3) Attach the manifold block assembly to be added to the DIN rail as shown in the figure.
- (4) Connect the block assemblies by pressing them together, and push the lever (b) in firmly until it stops.
Then secure them to the DIN rail by tightening the screws (a).

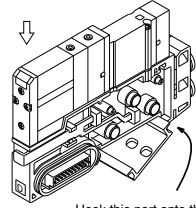

Hook this part onto the DIN rail, and press down in the direction of the arrow.

Figure. Block mounting procedure

⚠ Caution (Tightening torque: 1.4 N·m)

⚠ Caution

Fitting assembly replacement

By replacing manifold fitting assemblies, it is possible to change the size of the A, B ports and P, E ports. To replace them, Remove the clip with a flat head screwdriver, etc., and pull out the fitting assembly. Mount the new fitting assembly by inserting it and then replacing the clip to its fully inserted position.

Fitting Assembly Part No.

| | | Port size | SV1000 | SV2000 |
|-----------|--|------------------------------|----------------|-----------------|
| A, B Port | | One-touch fitting for ø3.2 | VVQ1000-50A-C3 | — |
| | | One-touch fitting for ø4 | VVQ1000-50A-C4 | VVQ1000-51A-C4 |
| | | One-touch fitting for ø6 | VVQ1000-50A-C6 | VVQ1000-51A-C6 |
| | | One-touch fitting for ø8 | — | VVQ1000-51A-C8 |
| | | One-touch fitting for ø1/8" | VVQ1000-50A-N1 | — |
| | | One-touch fitting for ø5/32" | VVQ1000-50A-N3 | VVQ1000-51A-N3 |
| | | One-touch fitting for ø1/4" | VVQ1000-50A-N7 | VVQ1000-51A-N7 |
| | | One-touch fitting to ø5/16" | — | VVQ1000-51A-N9 |
| P, E Port | | One-touch fitting for ø8 | VVQ1000-51A-C8 | — |
| | | One-touch fitting for ø10 | — | VVQ2000-51A-C10 |
| | | One-touch fitting for ø5/16" | VVQ1000-51A-N9 | — |
| | | One-touch fitting for ø3/8" | — | VVQ2000-51A-N11 |

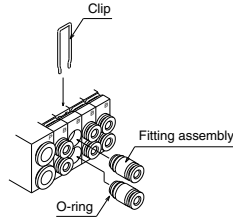

Note 1) Be careful to avoid damage or contamination of O-rings, as this can cause air leakage.

Note 2) When removing a fitting assembly from a valve, after removing the clip, attach tubing or a plug (KQ2P-□□) to the One-touch fitting, and pull it out while holding the tubing (or plug). If it is pulled out while holding the release button of the fitting assembly (resin part), the release button may be damaged.

Note 3) Be sure to shut off the power and air supplies before disassembly. Furthermore, since air may remain inside the actuator, piping and manifold, confirm that the air is completely exhausted before performing any work.

■ How to order cassette base type 16 solenoid valves with manifold block

[SV1000/SV2000 Series]

• Type with manifold block is used when adding stations, etc.

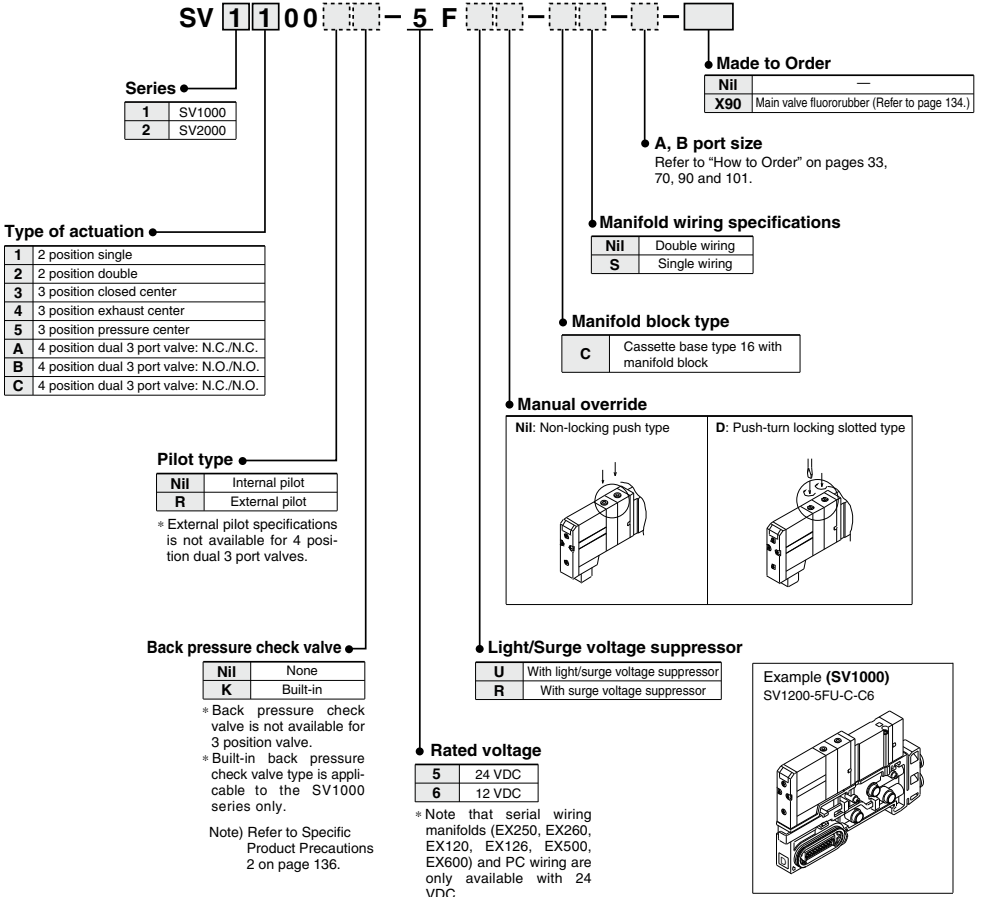

Type 10: Tie-rod Base Manifold Exploded View

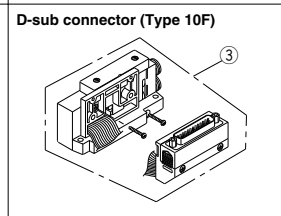
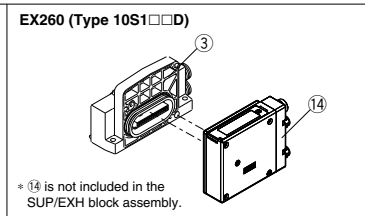
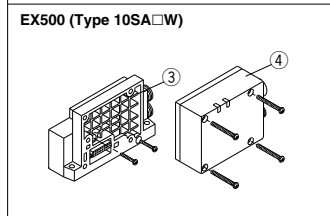
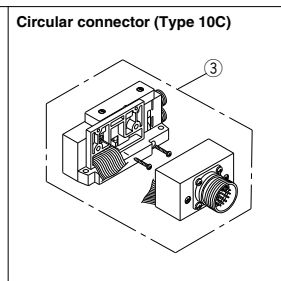
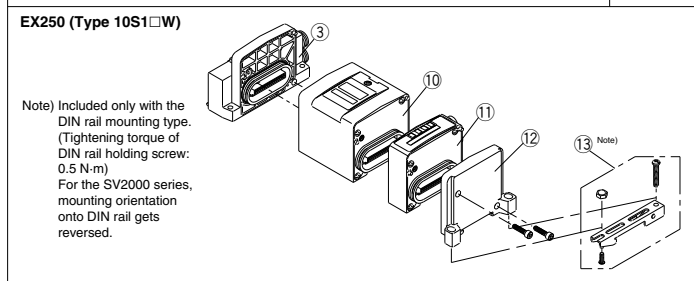
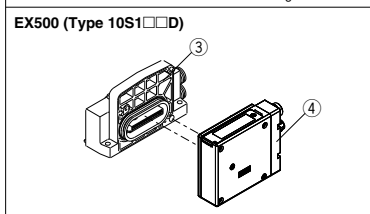
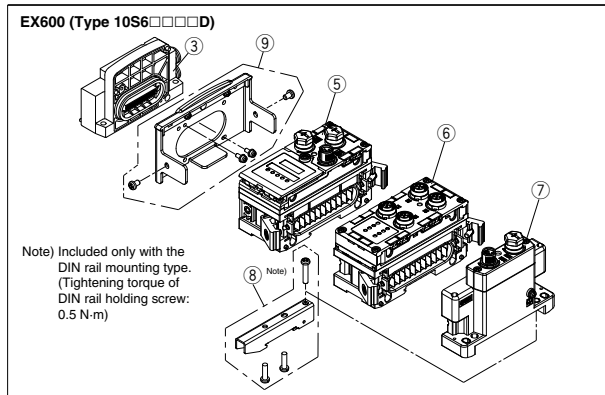
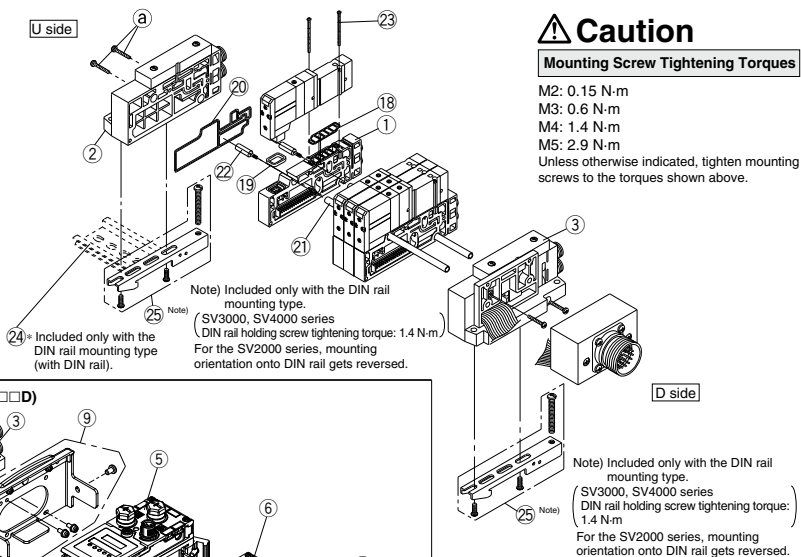

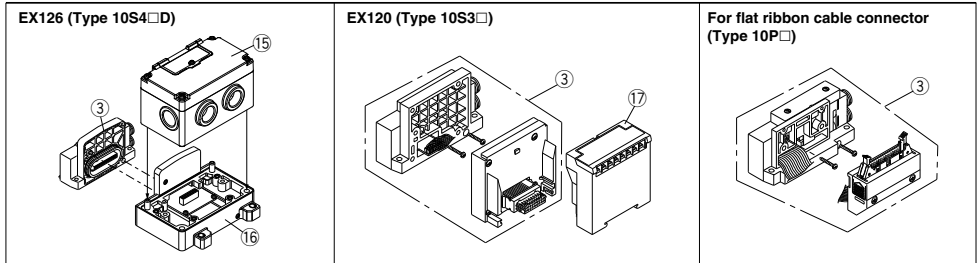

① Manifold Block Assembly Part No.

| Series | Wiring specifications | Manifold block assembly part no. | Note |
|--------|-----------------------|----------------------------------|--|
| SV1000 | Single | SV1000-50-1A-□□ | C3: With ø3.2 One-touch fitting N1: ø1/8" One-touch fitting C4: With ø4 One-touch fitting N3: ø5/32" One-touch fitting C6: With ø6 One-touch fitting N7: ø1/4" One-touch fitting (Tie-rod for station additions ② and gaskets ⑬, ⑭, and ⑯ are included.) |
| | Double | SV1000-50-2A-□□ | |
| SV2000 | Single | SV2000-50-1A-□□ | C4: With ø4 One-touch fitting N3: ø5/32" One-touch fitting C6: With ø6 One-touch fitting N7: ø1/4" One-touch fitting C8: With ø8 One-touch fitting N9: ø5/16" One-touch fitting (Tie-rod for station additions ② and gaskets ⑬, ⑭, and ⑯ are included.) |
| | Double | SV2000-50-2A-□□ | |
| SV3000 | Single | SV3000-50-1A-□□ | C6: With ø6 One-touch fitting N7: ø1/4" One-touch fitting C8: With ø8 One-touch fitting N9: ø5/16" One-touch fitting C10: With ø10 One-touch fitting N11: ø3/8" One-touch fitting (Tie-rod for station additions ② and gaskets ⑬, ⑭, and ⑯ are included.) |
| | Double | SV3000-50-2A-□□ | |
| SV4000 | Single | SV4000-50-1A-□□ | C8: With ø8 One-touch fitting N9: ø5/16" One-touch fitting C10: With ø10 One-touch fitting N11: ø3/8" One-touch fitting C12: With ø12 One-touch fitting O2: Rc 1/4 O2N: NPT 1/4 O3: Rc 3/8 O3N: NPT 3/8 O2F: G1/4 O2T: NPTF 1/4 O3F: G3/8 O3T: NPTF 3/8 (Tie-rod for station additions ② and gaskets ⑬, ⑭, and ⑯ are included.) |
| | Double | SV4000-50-2A-□□ | |

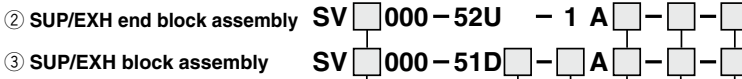

Series

| | |
|---|--------|
| 1 | SV1000 |
| 2 | SV2000 |
| 3 | SV3000 |
| 4 | SV4000 |

Connector entry direction
(D-sub, flat types only)

| | |
|---|---------|
| 1 | Upward |
| 2 | Lateral |

Mounting

| | |
|-----|-------------------|
| Nil | Direct mounting |
| DO | DIN rail mounting |

SUP/EXH block assembly specifications

| | |
|----|---|
| 10 | For EX600 (Gateway Decentralized System) For EX500 (Gateway Decentralized System 2) For EX600 |
| 11 | For EX250 For EX260 For EX126 |
| 12 | For circular connector |
| 13 | D-sub connector |
| 14 | For flat ribbon cable connector (26 pins) |
| 15 | For flat ribbon cable connector (20 pins) |
| 16 | For flat ribbon cable connector (10 pins) |
| 18 | For EX120 (dedicated output serial) |

Pilot type

| | |
|-----|----------------------------------|
| Nil | Internal pilot |
| S | Internal pilot/Built-in silencer |
| R | External pilot |
| RS | External pilot/Built-in silencer |

P, E port size

| | | |
|-----|--------------------------|------------|
| C8 | ø8 One-touch fitting | SV1000 |
| N9 | ø5/16" One-touch fitting | |
| C10 | ø10 One-touch fitting | SV2000 |
| N11 | ø3/8" One-touch fitting | |
| C12 | ø12 One-touch fitting | SV3000 |
| N11 | ø3/8" One-touch fitting | SV4000 |
| O3 | Rc 3/8 | |
| O3F | G 3/8 | SV4000 |
| O3N | NPT 3/8 | |
| O3T | NPTF 3/8 | |
| 00 | Plug | All series |
| 00U | Plug | All series |

Note 1) "00" (Plug) is not available for S, R and RS types.
Note 2) "00U" is available only for D-sub connectors and the lock bracket size is in inches.

* Since EX500, EX600, EX250, EX260, EX126 and EX120 type SI units are not included, order them separately.

Note that EX600 series EtherCAT compatible SI units (EX600-SEC1 and EX600-SEC2) are to be discontinued as of October 2022.

Type 10: Tie-rod Base Manifold Exploded View

| No. | Description | Part no. | | | | Note |
|-----|---|-----------------------------|-------------------------------|----------------------------|----------------------------|---|
| | | SV1000 | SV2000 | SV3000 | SV4000 | |
| 4 | EX500 series SI unit | | Refer to page 28. | | | Gateway Decentralized System 2 (128 points) |
| | | | Refer to page 33. | | | Gateway Decentralized System (64 points) |
| | | | EX600-SDN1A | | | DeviceNet® PNP (Negative common) |
| | | | EX600-SDN2A | | | DeviceNet® NPN (Positive common) |
| | | | EX600-SMJ1 | | | CC-Link PNP (Negative common) |
| | | | EX600-SMJ2 | | | CC-Link NPN (Positive common) |
| | | | EX600-SPR1A | | | PROFIBUS DP PNP (Negative common) |
| | | | EX600-SPR2A | | | PROFIBUS DP NPN (Positive common) |
| | | | EX600-SEN3 | | | EtherNet/IP™ (2 port) PNP (Negative common) |
| | | | EX600-SEN4 | | | EtherNet/IP™ (2 port) NPN (Positive common) |
| | | | EX600-SPN1 | | | PROFINET PNP (Negative common) |
| | | | EX600-SPN2 | | | PROFINET NPN (Positive common) |
| | | | EX600-SEC1 | | | EtherCAT PNP (Negative common) |
| | | | EX600-SEC2 | | | EtherCAT NPN (Positive common) |
| | | | EX600-WEN1 ^{Note 2)} | | | Wireless base module EtherNet/IP™ PNP (Negative common) |
| | | | EX600-WEN2 ^{Note 2)} | | | Wireless base module EtherNet/IP™ NPN (Positive common) |
| | | | EX600-WPN1 ^{Note 2)} | | | Wireless base module PROFINET PNP (Negative common) |
| | | | EX600-WPN2 ^{Note 2)} | | | Wireless base module PROFINET NPN (Positive common) |
| | | | EX600-WSV1 ^{Note 2)} | | | Wireless remote module PNP (Negative common) |
| | | | EX600-WSV2 ^{Note 2)} | | | Wireless remote module NPN (Positive common) |
| | | | EX600-DXNB | | | NPN input M12 connector 5 pins (4 pcs.) 8 inputs |
| | | | EX600-DXPB | | | PNP input M12 connector 5 pins (4 pcs.) 8 inputs |
| | | | EX600-DXNC | | | NPN input M8 connector 3 pins (8 pcs.) 8 inputs |
| | | | EX600-DXNC1 | | | NPN input M8 connector 3 pins (8 pcs.) 8 inputs, with open circuit detection |
| | | | EX600-DXPC | | | PNP input M8 connector 3 pins (8 pcs.) 8 inputs |
| | | | EX600-DXPC1 | | | PNP input M8 connector 3 pins (8 pcs.) 8 inputs, with open circuit detection |
| | | | EX600-DXND | | | NPN input M12 connector 5 pins (8 pcs.) 16 inputs |
| | | | EX600-DXPD | | | PNP input M12 connector 5 pins (8 pcs.) 16 inputs |
| | | | EX600-DXNE | | | NPN input D-sub connector 25 pins 16 inputs |
| | | | EX600-DXPE | | | PNP input D-sub connector 25 pins 16 inputs |
| | | | EX600-DXNF | | | NPN input spring type terminal block 32 pins 16 inputs |
| | | | EX600-DXPF | | | PNP input spring type terminal block 32 pins 16 inputs |
| | | | EX600-DYNB | | | NPN output M12 connector 5 pins (4 pcs.) 8 outputs |
| | | | EX600-DYPB | | | PNP output M12 connector 5 pins (4 pcs.) 8 outputs |
| | | | EX600-DYNE | | | NPN output D-sub connector 25 pins 16 outputs |
| | | | EX600-DYPE | | | PNP output D-sub connector 25 pins 16 outputs |
| | | | EX600-DYNF | | | NPN output spring type terminal block 32 pins 16 outputs |
| | | | EX600-DYPE | | | PNP output spring type terminal block 32 pins 16 outputs |
| | | | EX600-DMNE | | | NPN input/output D-sub connector 25 pins 8 inputs/outputs |
| | | | EX600-DMPE | | | PNP input/output D-sub connector 25 pins 8 inputs/outputs |
| | | | EX600-DMNF | | | NPN input/output spring type terminal block 32 pins 8 inputs/outputs |
| | | | EX600-DMPF | | | PNP input/output spring type terminal block 32 pins 8 inputs/outputs |
| | EX600 series analog input unit | | EX600-AXA | | | M12 connector 5 pins (2 pcs.), 2-channel input |
| | EX600 series analog output unit | | EX600-AYA | | | M12 connector 5 pins (2 pcs.), 2-channel output |
| | EX600 series analog input/output unit | | EX600-AMB | | | M12 connector 5 pins (4 pcs.), 2-channel input/output |
| | | | EX600-ED2 | | | M12 power supply connector, B-coded |
| | | | EX600-ED2-2 | | | M12 power supply connector, B-coded, with DIN rail mounting bracket |
| | | | EX600-ED3 | | | 7/8 inch power supply connector |
| | | | EX600-ED3-2 | | | 7/8 inch power supply connector, with DIN rail mounting bracket |
| | | | EX600-ED4 | | | M12 power supply connector IN/OUT, A-coded, Pin arrangement 1 |
| | | | EX600-ED4-2 | | | M12 power supply connector IN/OUT, A-coded, Pin arrangement 1, with DIN rail mounting bracket |
| | | | EX600-ED5 | | | M12 power supply connector IN/OUT, A-coded, Pin arrangement 2 |
| | | | EX600-ED5-2 | | | M12 power supply connector IN/OUT, A-coded, Pin arrangement 2, with DIN rail mounting bracket |
| 8 | Clamp assembly for EX600 | | EX600-ZMA2 | | | With mounting screws (M4 x 20 1 pc., M4 x 12 2 pcs.) |
| 9 | Valve plate for EX600 | | EX600-ZMV1 | | | Enclosed parts: round head screws (M4 x 6) 2 pcs., round head screws (M3 x 8) 4 pcs. |
| 10 | EX250 series SI unit | | Refer to page 42. | | | M12, 2 inputs |
| | | | EX250-IE1 | | | M12, 4 inputs |
| | | | EX250-IE2 | | | M8, 4 inputs (3 pins) |
| | | | EX250-IE3 | | | With mounting screws (M3 x 10, 2 pcs.) |
| 12 | EX250 series end plate assembly | | EX250-EA1 | | | |
| 13 | For EX250 clamp assembly | | SV1000-78A | | | |
| 14 | EX260 series SI unit | | Refer to page 58. | | | |
| 15 | EX126 series SI unit | | Refer to page 64. | | | |
| 16 | Terminal block plate | | VVQC1000-74A-2 | | | For mounting EX126 SI unit |
| 17 | EX120 series SI unit | | Refer to page 70. | | | |
| 18 | Gasket | SX3000-57-4 | SX5000-57-6 | SX7000-57-5 | SY9000-11-2 | |
| 19 | Connector gasket | SX3000-146-2 | SX3000-146-2 | SX3000-146-2 | SX3000-146-2 | |
| 20 | Manifold block gasket | SX3000-181-1 | SV5000-138-1 | SV3000-65-1 | SV4000-65-2 | |
| 21 | Tie-rod | SV1000-55-1-□□ | SV2000-55-1-□□ | SV3000-55-1-□□ | SV4000-55-1-□□ | □□: Manifold stations |
| 22 | Tie-rod for station addition | SV1000-55-2-1 | SV2000-55-2A | SV3000-55-2A | SV4000-55-2A | |
| 23 | Round head combination screw (Valve mounting screw) | SX3000-22-2 (M2 x 24) | SV2000-21-1 (M3 x 30) | SV3000-21-1 (M4 x 35) | SV2000-21-2 (M3 x 40) | |
| | | Tightening torque: 0.16 N·m | Tightening torque: 0.8 N·m | Tightening torque: 1.4 N·m | Tightening torque: 0.8 N·m | |
| 24 | DIN rail | VZ1000-11-1-□ | VZ1000-11-1-□ | VZ1000-11-4-□ | VZ1000-11-4-□ | Refer to DIN rail dimension tables on page 123. |
| 25 | Clamp assembly | SV1000-69A | SV1000-69A | SV3000-69A | SV3000-69A | |
| | Clamp assembly for EX600 | SV1000-69A | SV2000-75A | SV3000-69A | | |

Note 1) Two pieces of 21 and 22 (tie-rod) are required for the SV1000 series, and three pieces are required for the SV2000, 3000 and 4000 series.
Two pieces of 23 (valve mounting screw) are required for the SV1000, 2000 and 3000 series, and three pieces are required for the SV4000 series.

Note 2) The wireless system is suitable for use only in a country where it is in accordance with the Radio Act and regulations of that country.

Type 10: Tie-rod Base Manifold

How to increase manifold bases (Type 10)

- (1) Loosen the U side screws (a), and remove the SUP/EXH end block assembly (2).

- (2) Screw in the tie-rods (14) for station addition.
(Screw them in until there is no gap between the tie-rods.)

- (3) Connect the manifold assembly (1) and supply/exhaust end block assembly (2) to be added, and tighten the screws (a).

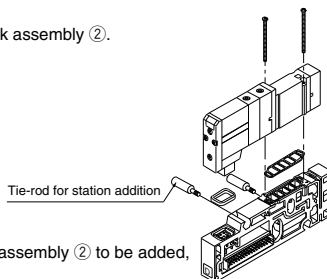

- ⚠ Caution** Tightening torques (a)
- | | |
|----------------|---------|
| SV1000, SV2000 | 0.6 N·m |
| SV3000 | 1.4 N·m |
| SV4000 | 2.9 N·m |

Note) When eliminating manifold stations, the appropriate tie-rods (13) for the desired change should be ordered separately.
(When equipped with a DIN rail, be sure to tighten the DIN rail holding screws after tightening the tension bolts.)

⚠ Caution

Fitting Assembly Replacement

By replacing manifold fitting assemblies, it is possible to change the size of the A, B ports and P, E ports. To replace them, remove the clip with a flat head screwdriver, etc., and pull out the fitting assembly. Mount the new fitting assembly by inserting it and then replacing the clip to its fully inserted position.

Fitting Assembly Part No.

| Port size | | SV1000 | SV2000 | SV3000 | SV4000 |
|---------------------------------------|------------------------------|----------------|-----------------|-----------------|-----------------|
| A, B Port | One-touch fitting for ø3.2 | VVQ1000-50A-C3 | — | — | — |
| | One-touch fitting for ø4 | VVQ1000-50A-C4 | VVQ1000-51A-C4 | — | — |
| | One-touch fitting for ø6 | VVQ1000-50A-C6 | VVQ1000-51A-C6 | VVQ2000-51A-C6 | — |
| | One-touch fitting for ø8 | — | VVQ1000-51A-C8 | VVQ2000-51A-C8 | VVQ4000-50B-C8 |
| | One-touch fitting for ø10 | — | — | VVQ2000-51A-C10 | VVQ4000-50B-C10 |
| | One-touch fitting for ø12 | — | — | — | VVQ4000-50B-C12 |
| | One-touch fitting for ø1/8" | VVQ1000-50A-N1 | — | — | — |
| | One-touch fitting for ø5/32" | VVQ1000-50A-N3 | VVQ1000-51A-N3 | — | — |
| | One-touch fitting for ø1/4" | VVQ1000-50A-N7 | VVQ1000-51A-N7 | VVQ2000-51A-N7 | — |
| | One-touch fitting for ø5/16" | — | VVQ1000-51A-N9 | VVQ2000-51A-N9 | VVQ4000-50B-N9 |
| One-touch fitting for ø3/8" | — | — | VVQ2000-51A-N11 | VVQ4000-50B-N11 | |
| 1/4 threaded type port block assembly | — | — | — | SY9000-58A-02□ | |
| 3/8 threaded type port block assembly | — | — | — | SY9000-58A-03□ | |
| P, E Port | One-touch fitting for ø8 | VVQ1000-51A-C8 | — | — | — |
| | One-touch fitting for ø10 | — | VVQ2000-51A-C10 | — | — |
| | One-touch fitting for ø12 | — | — | VVQ4000-50B-C12 | VVQ4000-50B-C12 |
| | One-touch fitting for ø5/16" | VVQ1000-51A-N9 | — | — | — |
| | One-touch fitting for ø3/8" | — | VVQ2000-51A-N11 | VVQ4000-50B-N11 | VVQ4000-50B-N11 |
| 3/8 threaded type port block assembly | — | — | — | SY9000-58B-03□ | |

■ 1/4, 3/8 thread type port block assembly

For A, B port

SY9000-58A-02 03

For P, E port

SY9000-58B-03 03



● Thread type

| | |
|-----|------|
| Nil | Rc |
| F | G |
| N | NPT |
| T | NPTF |

Note 1) Be careful to avoid damage or contamination of O-rings, as this can cause air leakage.

Note 2) When removing a fitting assembly from a valve, after removing the clip, attach tubing or a plug (KQP-□□) to the One-touch fitting, and pull it out while holding the tubing (or plug). If it is pulled out while holding the release button of the fitting assembly (resin part), the release button may be damaged.

However, 02 and 03 port block assemblies should be pulled out as they are.

Note 3) Be sure to shut off the power and air supplies before disassembly. Furthermore, since air may remain inside the actuator, piping and manifold, confirm that the air is completely exhausted before performing any work.

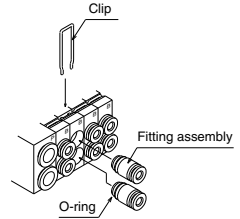

■ How to order tie-rod type 10 solenoid valves with manifold block

[SV1000 to SV4000 series]

• Type with manifold block is used when adding stations, etc.

SV 1 1 00 - 5 F - - - -

Series ●

| | |
|---|--------|
| 1 | SV1000 |
| 2 | SV2000 |
| 3 | SV3000 |
| 4 | SV4000 |

Type of actuation ●

| | |
|---|---|
| 1 | 2 position single |
| 2 | 2 position double |
| 3 | 3 position closed center |
| 4 | 3 position exhaust center |
| 5 | 3 position pressure center |
| A | 4 position dual 3 port valve: N.C./N.C. |
| B | 4 position dual 3 port valve: N.O./N.O. |
| C | 4 position dual 3 port valve: N.C./N.O. |

*4 position dual 3 port valves are applicable to the SV1000 and SV2000 series only.

Pilot type ●

| | |
|-----|----------------|
| Nil | Internal pilot |
| R | External pilot |

* External pilot specifications is not available for 4 position dual 3 port valves.

Back pressure check valve ●

| | |
|-----|----------|
| Nil | None |
| K | Built-in |

* Built-in back pressure check valve type is applicable to the SV1000 series only.

* Back pressure check valve is not available for 3 position valve.

(Note) Refer to Specific Product Precautions 2 on page 136.

● A, B port size

Refer to "How to Order" on pages 33, 42, 64, 70, 90 and 101.

● Manifold wiring specifications

| | |
|-----|---------------|
| Nil | Double wiring |
| S | Single wiring |

Made to Order ●

| | |
|-----|--|
| Nil | — |
| X90 | Main valve fluororubber (Refer to page 134.) |

● Manifold block type

| | |
|---|--|
| T | For Tie-rod base type 10 with manifold block |
|---|--|

Note) Tie-rod type 10 includes tie-rods for station additions.

● Manual override

Nil: Non-locking push type

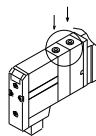

D: Push-turn locking slotted type

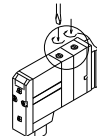

● Light/Surge voltage suppressor

| | |
|---|-------------------------------------|
| U | With light/surge voltage suppressor |
| R | With surge voltage suppressor |

● Rated voltage

| | |
|---|--------|
| 5 | 24 VDC |
| 6 | 12 VDC |

* Note that serial wiring (EX500, EX250 and EX12□) are only available with 24 VDC.

Example (SV1000)
SV1200-5FU-T-C6

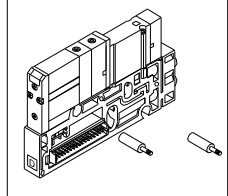

Manifold Options (Common for Type 16 and 10)

Relay output module

By adding a relay output module to a SV series manifold, devices up to 110 VAC, 3 A (large type solenoid valves, etc.) can be controlled together with the SV series valves.

How to Order

SV 000-60-5 A-1A

Series ●

| | |
|---|--------|
| 1 | SV1000 |
| 2 | SV2000 |
| 3 | SV3000 |
| 4 | SV4000 |

● No. of output point

| | |
|---|-----------|
| A | 1 output |
| B | 2 outputs |

● Rated voltage

| | |
|---|--------|
| 5 | 24 VDC |
| 6 | 12 VDC |

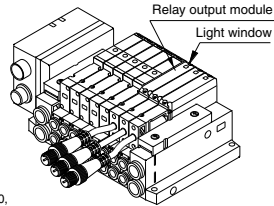

* Note that serial wiring manifolds (EX500, EX250 and EX12□) are available with 24 VDC only.

Relay Output Module Specifications

| Item | Specifications | | | |
|----------------------|---|--------|--|--------|
| No. of output points | 1 output [connector with lead wire (M12)] | | 2 outputs [connector with lead wire (M12)] | |
| Output type | <p>Contact type ("a" contact)</p> | | <p>Contact type ("a" contact)</p> | |
| Load voltage | 110 VAC | 30 VDC | 110 VAC | 30 VDC |
| Load current | 3 A | 3 A | 0.3 A | 1 A |
| Indicator light | Red | | | |
| Enclosure | Based on IP67 (IEC60529) | | | |
| Current consumption | 20 mA or less | | | |
| Polarity | Non-polar | | | |
| weight (g) | 48 | | | |

Connection Destination (Female Side) Connector Cable

| Connector size | pin | Manufacturer | Applicable series |
|----------------|-----|---------------------------|-------------------|
| M12 | 4 | Correns Corp. | VA-4D |
| | | OMRON Corp. | XS2 |
| | | Azbil Corp. | PA5-41 |
| | | HIROSE ELECTRIC CO., LTD. | HR24 |
| | | DDK Ltd. | CM01-8DP4S |

* This connector is a female connector for ① relay output module and ② single unit/sub-plate.

Manifold Options

■ Blanking plate assembly

Used in situations where valves will be added in the future or for maintenance.

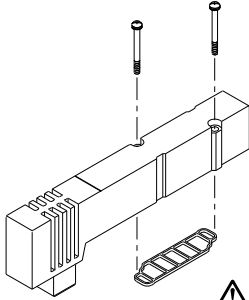

| Series | Blanking plate assembly part no. |
|--------|----------------------------------|
| SV1000 | SV1000-67-1A |
| SV2000 | SV2000-67-1A |
| SV3000 | SV3000-67-1A |
| SV4000 | SV4000-67-1A |

⚠ Caution

Mounting screw
tightening torques

M2: 0.16 N·m
M3: 0.8 N·m
M4: 1.4 N·m

■ SUP/EXH block disk

[SUP block disk]
By placing a SUP block disk in a manifold valve's pressure supply passage, two different high and low pressures can be supplied to one manifold.

[EXH block disk]
By installing an EXH block disk in a manifold valve's exhaust passage, the valve's exhaust can be separated so that it will not affect other valves. It can also be used on a manifold with mixed positive pressure and vacuum.

(Two pieces are required to block EXH on both sides. However, the SV1000 and 2000 series type 10 manifolds require only one piece.)

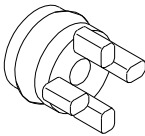

Cassette base type 16

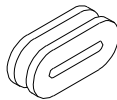

Tie-rod base type 10

| Series | Manifold Model | SUP block disk | EXH block disk |
|--------|----------------|----------------|----------------|
| SV1000 | 10 | SV1000-59-1A | SV1000-59-2A |
| | 16 | SX3000-77-1A | SX3000-77-1A |
| SV2000 | 10 | SV2000-59-1A | SV2000-59-2A |
| | 16 | SV2000-59-3A | SV2000-59-3A |
| SV3000 | 10 | SV3000-59-1A | SV3000-59-1A |
| SV4000 | 10 | SY9000-57-1A | SY9000-57-1A |

■ Label for block disk

These labels are attached to manifolds in which SUP and EXH block disks have been installed, in order to identify the installed locations. (Three sheets each included.)

SV1000-74-1A

Label for SUP
block disk



Label for EXH
block disk

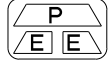

Label for SUP/EXH
block disk



* When a block disk is concurrently ordered by specifying on the manifold specification sheet, etc., a label will be stuck on the position where block disk is mounted.

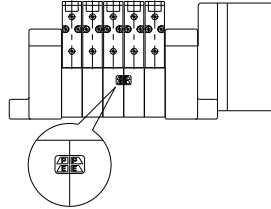

■ Silencer (Compact resin type/One-touch fitting connection)

AN10-C to AN30-C

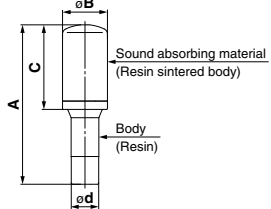

Dimensions

| Series | Model | A | B | C | ϕd |
|---------------------------------|----------|------|------|------|-----------|
| SV1000 (For $\phi 8$) | AN15-C08 | 4.5 | 13 | 20 | $\phi 8$ |
| SV2000 (For $\phi 10$) | AN20-C10 | 57.5 | 16.5 | 30.5 | $\phi 10$ |
| SV3000, SV4000 (For $\phi 12$) | AN30-C12 | 71.5 | 20 | 43.5 | $\phi 12$ |

■ Plug

These are inserted in unused cylinder ports and P, E ports.

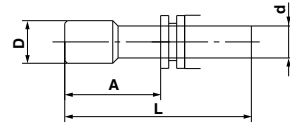

| Applicable fitting size d | Model | A | L | D |
|---------------------------|---------|------|------|-------------|
| $\phi 4$ | KQ2P-04 | 16 | 32 | $\phi 6$ |
| $\phi 6$ | KQ2P-06 | 18 | 35 | $\phi 8$ |
| $\phi 8$ | KQ2P-08 | 20.5 | 39 | $\phi 10$ |
| $\phi 10$ | KQ2P-10 | 22 | 43 | $\phi 12$ |
| $\phi 12$ | KQ2P-12 | 24 | 44.5 | $\phi 14$ |
| $\phi 1/8"$ | KQ2P-01 | 16 | 31.5 | $\phi 5$ |
| $\phi 5/32"$ | KQ2P-03 | 16 | 32 | $\phi 6$ |
| $\phi 1/4"$ | KQ2P-07 | 18 | 35 | $\phi 8.5$ |
| $\phi 5/16"$ | KQ2P-09 | 20.5 | 39 | $\phi 10$ |
| $\phi 3/8"$ | KQ2P-11 | 22 | 43 | $\phi 11.5$ |

Manifold Options

■ Circular connector/Cable assembly (26 pins)

AXT100 – MC26 – □

Lead Wire Length

| Part no. | L dimension |
|-----------------|-------------|
| AXT100-MC26-015 | 1.5 m |
| AXT100-MC26-030 | 3 m |
| AXT100-MC26-050 | 5 m |

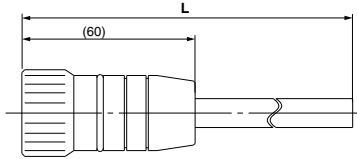

Plug terminal no.
(arrangement as seen from lead wire side)

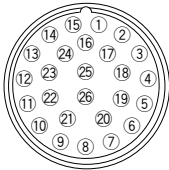

Circular Connector Cable Assembly Terminal No.

| Terminal no. | Lead wire color | Dot marking |
|--------------|-----------------|-------------|
| ① | Black | None |
| ② | Brown | None |
| ③ | Red | None |
| ④ | Orange | None |
| ⑤ | Yellow | None |
| ⑥ | Pink | None |
| ⑦ | Blue | None |
| ⑧ | Purple | White |
| ⑨ | Gray | Black |
| ⑩ | White | Black |
| ⑪ | White | Red |
| ⑫ | Yellow | Red |
| ⑬ | Orange | Red |
| ⑭ | Yellow | Black |
| ⑮ | Pink | Black |
| ⑯ | Blue | White |
| ⑰ | Purple | None |
| ⑱ | Gray | None |
| ⑲ | Orange | Black |
| ⑳ | Red | White |
| ㉑ | Brown | White |
| ㉒ | Pink | Red |
| ㉓ | Gray | Red |
| ㉔ | Black | White |
| ㉕ | White | None |

Note) Terminal no. ㉕ is connected to ㉓ inside the connector.

■ D-sub connector/Cable assembly (25 pins)

AXT100 – DS25 – □

Lead Wire Length

| Part no. | L dimension |
|-----------------|-------------|
| AXT100-DS25-015 | 1.5 m |
| AXT100-DS25-030 | 3 m |
| AXT100-DS25-050 | 5 m |

When a commercially available connector is required, use a 25 pin female connector conforming to MIL-C24308.

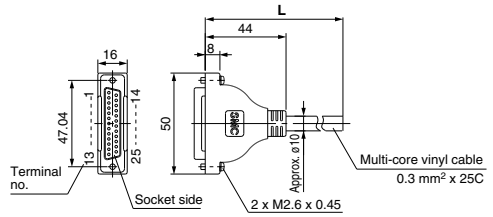

D-sub Connector Cable Assembly Terminal No.

| Terminal no. | Lead wire color | Dot marking |
|--------------|-----------------|-------------|
| ① | Black | None |
| ② | Brown | None |
| ③ | Red | None |
| ④ | Orange | None |
| ⑤ | Yellow | None |
| ⑥ | Pink | None |
| ⑦ | Blue | None |
| ⑧ | Purple | White |
| ⑨ | Gray | Black |
| ⑩ | White | Black |
| ⑪ | White | Red |
| ⑫ | Yellow | Red |
| ⑬ | Orange | Red |
| ⑭ | Yellow | Black |
| ⑮ | Pink | Black |
| ⑯ | Blue | White |
| ⑰ | Purple | None |
| ⑱ | Gray | None |
| ⑲ | Orange | Black |
| ⑳ | Red | White |
| ㉑ | Brown | White |
| ㉒ | Pink | Red |
| ㉓ | Gray | Red |
| ㉔ | Black | White |
| ㉕ | White | None |

Circular Connector, D-sub Connector Cable Assembly Electric Characteristics

| Item | Characteristics |
|-----------------------------------|-----------------|
| Conductor resistance Ω/km, 20°C | 65 or less |
| Withstand voltage VAC, 1 min. | 1000 |
| Insulation resistance, MΩkm, 20°C | 5 or less |

Note) The minimum inside bending radius for each cable is 20 mm.

Manifold Options

■ Flat ribbon cable/Cable assembly

AXT100 – FC □ – □

| Cable length (L) | 10 pins | 20 pins | 26 pins |
|---------------------|---------------|---------------|---------------|
| 1.5 m | AXT100-FC10-1 | AXT100-FC20-1 | AXT100-FC26-1 |
| 3 m | AXT100-FC10-2 | AXT100-FC20-2 | AXT100-FC26-2 |
| 5 m | AXT100-FC10-3 | AXT100-FC20-3 | AXT100-FC26-3 |
| Connector width (W) | 17.2 | 30 | 37.5 |

* For other commercial connectors, use a type with strain relief conforming to MIL-C-83503.

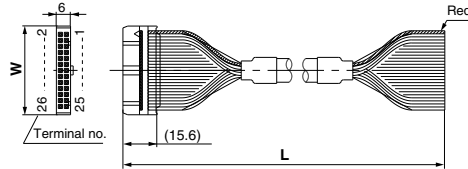

Connector manufacturers' example

- HIROSE ELECTRIC CO., LTD.
- 3M Japan Limited
- Fujitsu Limited
- Japan Aviation Electronics Industry, Limited
- J.S.T. Mfg. Co., Ltd.

■ Connector cable for M12 waterproof connector (Female side)

Connector manufacturers' example
Correns Corp.
OMRON Corp.
Azbil Corp.
HIROSE ELECTRIC CO., LTD.
DDK Ltd.

■ SV1000/2000 and the EX500 series input unit DIN rail dimensions and mass

VZ1000 – 11 – 1 – □

* As for □, enter the number from the DIN rail dimensions table.

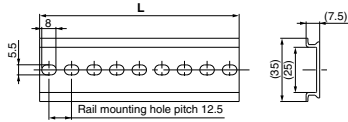

| | | | | | | | | | | |
|-------------|-------|-------|-------|-------|-------|-------|-------|-------|-------|-------|
| No. | 0 | 1 | 2 | 3 | 4 | 5 | 6 | 7 | 8 | 9 |
| L dimension | 98 | 110.5 | 123 | 135.5 | 148 | 160.5 | 173 | 185.5 | 198 | 210.5 |
| Mass (g) | 17.6 | 19.9 | 22.1 | 24.4 | 26.6 | 28.9 | 31.1 | 33.4 | 35.6 | 37.9 |
| No. | 10 | 11 | 12 | 13 | 14 | 15 | 16 | 17 | 18 | 19 |
| L dimension | 223 | 235.5 | 248 | 260.5 | 273 | 285.5 | 298 | 310.5 | 323 | 335.5 |
| Mass (g) | 40.1 | 42.4 | 44.6 | 46.9 | 49.1 | 51.4 | 53.6 | 55.9 | 58.1 | 60.4 |
| No. | 20 | 21 | 22 | 23 | 24 | 25 | 26 | 27 | 28 | 29 |
| L dimension | 348 | 360.5 | 373 | 385.5 | 398 | 410.5 | 423 | 435.5 | 448 | 460.5 |
| Mass (g) | 62.5 | 64.9 | 67.1 | 69.4 | 71.6 | 73.9 | 76.1 | 78.4 | 80.6 | 82.9 |
| No. | 30 | 31 | 32 | 33 | 34 | 35 | 36 | 37 | 38 | 39 |
| L dimension | 473 | 485.5 | 498 | 510.5 | 523 | 535.5 | 548 | 560.5 | 573 | 585.5 |
| Mass (g) | 85.1 | 87.4 | 89.6 | 91.9 | 94.1 | 96.4 | 98.6 | 100.9 | 103.1 | 105.4 |
| No. | 40 | 41 | 42 | 43 | 44 | 45 | 46 | 47 | 48 | 49 |
| L dimension | 598 | 610.5 | 623 | 635.5 | 648 | 660.5 | 673 | 685.5 | 698 | 710.5 |
| Mass (g) | 107.6 | 109.9 | 112.1 | 114.4 | 116.6 | 118.9 | 121.1 | 123.4 | 125.6 | 127.9 |
| No. | 50 | 51 | 52 | 53 | 54 | 55 | 56 | 57 | 58 | 59 |
| L dimension | 723 | 735.5 | 748 | 760.5 | 773 | 785.5 | 798 | 810.5 | 823 | 835.5 |
| Mass (g) | 130.1 | 132.4 | 134.6 | 136.9 | 139.1 | 141.4 | 143.6 | 145.9 | 148.1 | 150.4 |
| No. | 60 | 61 | 62 | 63 | 64 | 65 | 66 | 67 | 68 | 69 |
| L dimension | 848 | 860.5 | 873 | 885.5 | 898 | 910.5 | 923 | 935.5 | 948 | 960.5 |
| Mass (g) | 152.6 | 154.9 | 157.1 | 159.4 | 161.6 | 163.9 | 166.1 | 168.4 | 170.6 | 172.9 |
| No. | 70 | 71 | | | | | | | | |
| L dimension | 973 | 985.5 | | | | | | | | |
| Mass (g) | 175.1 | 177.4 | | | | | | | | |

■ SV3000 and 4000 DIN rail dimensions and mass

VZ1000 – 11 – 4 – □

* As for □, enter the number from the DIN rail dimensions table.

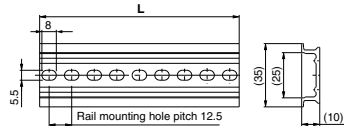

| | | | | | | | | | | | | | | | | | | | | | |
|-------------|-------|-------|-------|-------|-------|-------|-------|-------|-------|-------|-------|-------|-------|-------|-------|-------|-------|-------|-------|-------|-------|
| No. | 0 | 1 | 2 | 3 | 4 | 5 | 6 | 7 | 8 | 9 | 10 | 11 | 12 | 13 | 14 | 15 | 16 | 17 | 18 | 19 | 20 |
| L dimension | 98 | 110.5 | 123 | 135.5 | 148 | 160.5 | 173 | 185.5 | 198 | 210.5 | 223 | 235.5 | 248 | 260.5 | 273 | 285.5 | 298 | 310.5 | 323 | 335.5 | 348 |
| Mass (g) | 24.8 | 28 | 31.1 | 34.3 | 37.4 | 40.6 | 43.8 | 46.9 | 50.1 | 53.3 | 56.4 | 59.6 | 62.7 | 65.9 | 69.1 | 72.2 | 75.4 | 78.6 | 81.7 | 84.9 | 88 |
| No. | 21 | 22 | 23 | 24 | 25 | 26 | 27 | 28 | 29 | 30 | 31 | 32 | 33 | 34 | 35 | 36 | 37 | 38 | 39 | 40 | 41 |
| L dimension | 360.5 | 373 | 385.5 | 398 | 410.5 | 423 | 435.5 | 448 | 460.5 | 473 | 485.5 | 498 | 510.5 | 523 | 535.5 | 548 | 560.5 | 573 | 585.5 | 598 | 610.5 |
| Mass (g) | 91.2 | 94.4 | 97.5 | 100.7 | 103.9 | 107 | 110.2 | 113.3 | 116.5 | 119.7 | 122.8 | 126 | 129.2 | 132.3 | 135.5 | 138.6 | 141.8 | 145 | 148.1 | 151.3 | 154.5 |
| No. | 42 | 43 | 44 | 45 | 46 | 47 | 48 | 49 | 50 | 51 | 52 | 53 | 54 | 55 | 56 | 57 | 58 | 59 | 60 | 61 | 62 |
| L dimension | 623 | 635.5 | 648 | 660.5 | 673 | 685.5 | 698 | 710.5 | 723 | 735.5 | 748 | 760.5 | 773 | 785.5 | 798 | 810.5 | 823 | 835.5 | 848 | 860.5 | 873 |
| Mass (g) | 157.6 | 160.8 | 163.9 | 167.1 | 170.3 | 173.4 | 176.6 | 179.8 | 182.9 | 186.1 | 189.2 | 192.4 | 195.6 | 198.7 | 201.9 | 205.1 | 208.2 | 211.4 | 214.5 | 217.7 | 220.9 |
| No. | 63 | 64 | 65 | 66 | 67 | 68 | 69 | 70 | 71 | | | | | | | | | | | | |
| L dimension | 885.5 | 898 | 910.5 | 923 | 935.5 | 948 | 960.5 | 973 | 985.5 | | | | | | | | | | | | |
| Mass (g) | 224 | 227.2 | 230.4 | 233.5 | 236.7 | 239.8 | 243 | 246.2 | 249.3 | | | | | | | | | | | | |

SV Series

Manifold Options

Interface Regulator How to Order Interface Regulator

SV1000 Series

SV1 0 00 - 05 - P

Applicable valve Note 3)

| | |
|---|--------------------------------|
| 0 | For single, double, 4 position |
| 3 | For 3 position |

Pressure gauge option Note 1)

| | |
|----|--|
| M1 | Without pressure gauge |
| 05 | With MPa indication pressure gauge [For odd number station] |
| 06 | With MPa indication pressure gauge [For even number station] |
| N5 | With psi indication pressure gauge [For odd number station] |
| N6 | With psi indication pressure gauge [For even number station] |

Note 2)

Note 2)

Regulating port

| | |
|----|---|
| P | P port |
| A1 | A port (P controlled type, A port regulation) |
| B1 | B port (P controlled type, B port regulation) |

SV2000/3000/4000 Series

SV 2 000 - 00 - P

Series

| | |
|---|--------|
| 2 | SV2000 |
| 3 | SV3000 |
| 4 | SV4000 |

Regulating port

| | |
|----|---|
| P | P port |
| A1 | A port (P controlled type, A port regulation) |
| B1 | B port (P controlled type, B port regulation) |

Note 1) 1(P) port pressure regulation is only available for 3-position closed center and pressure closed center, and 4-position dual 3-port valves.

Pressure gauge option

| | |
|----|------------------------------------|
| M1 | Without pressure gauge |
| 00 | With MPa indication pressure gauge |
| N0 | With psi indication pressure gauge |

Note 2)

Note 1) In the case of the SV1000 series with a pressure gauge when mounting on the manifold, use caution that the part numbers are different between the odd no. stations and the even no. stations to avoid pressure gauges from interfering from each others.

Note 2) The units with the psi indication are sold only overseas according to the new measurement law in Japan.

Note 3) Use caution that the part numbers will differ depending on the one for single/double and 4- and 3-position due to the different length of solenoid valves. Also, if the one for 3 position is included in the same manifold, use all the ones for 3-position.

SV1000-05/N5-□
(For mounting odd number stations)

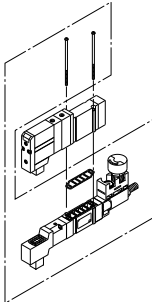

SV1000-06/N6-□
(For mounting even number stations)

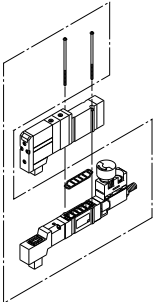

SV1000-M1-□

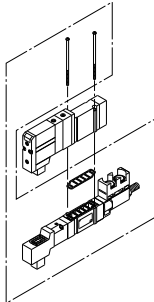

SV2000-00/N0-□

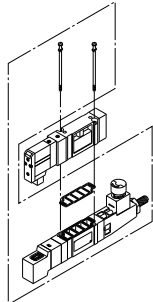

SV2000-M1-□

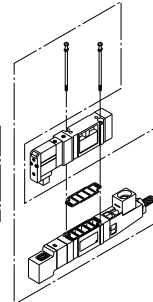

SV3000-00/N0-□

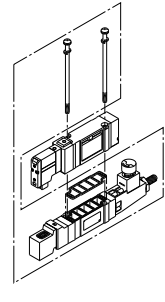

SV3000-M1-□

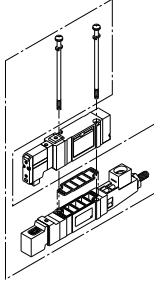

SV4000-00/N0-□

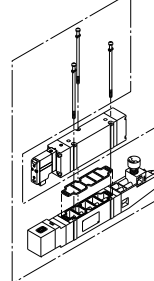

SV4000-M1-□

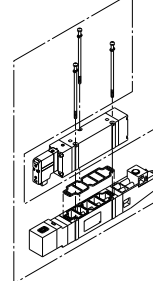

Symbol

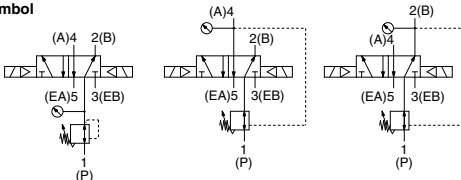

Accessory

| Series | Round head combination screw | Gasket |
|--------|------------------------------|-------------|
| SV1000 | SX3000-22-9 (M2 x 39.5) | SX3000-57-4 |
| SV2000 | SV2000-21-7 (M3 x 53) | SX5000-57-6 |
| SV3000 | SV3000-21-4 (M4 x 57) | SX7000-57-5 |
| SV4000 | SV2000-21-8 (M3 x 69.5) | SY9000-11-2 |

⚠ Caution

Mounting Screw Tightening Torques

M2: 0.16 N·m
M3: 0.8 N·m
M4: 1.4 N·m

Manifold Option

■ Individual SUP spacer assembly

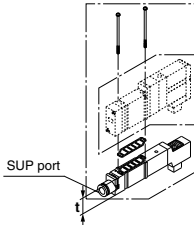

■ Individual EXH spacer assembly

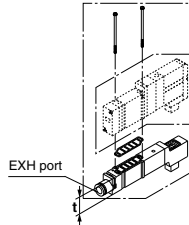

How to order individual SUP/EXH spacer assembly

SV1000 Series

SV1000 - **38** - 1A - **C6**

* t: 15

SV2000/SV3000/SV4000 Series

SV **2** 000 - **38** - 1 **A**

● Port size

| | |
|-----------|------------------------------------|
| C3 | One-touch fitting for $\phi 3.2$ |
| C4 | One-touch fitting for $\phi 4$ |
| C6 | One-touch fitting for $\phi 6$ |
| N1 | One-touch fitting for $\phi 1/8"$ |
| N3 | One-touch fitting for $\phi 5/32"$ |
| N7 | One-touch fitting for $\phi 1/4"$ |

● Series

| Symbol | Series | t |
|----------|--------|------|
| 2 | SV2000 | 15 |
| 3 | SV3000 | 18.5 |
| 4 | SV4000 | 20 |

● Thread type (Note)

| NH | Rc |
|----------|------|
| F | G |
| N | NPT |
| T | NPTF |

● Spacer type

| | |
|-----------|--|
| 38 | Individual SUP spacer |
| 39 | Individual EXH spacer |
| 88 | Individual SUP + Individual EXH spacers (Double-stack) |

* In the SV3000 series, only type 10 is compatible with the double-stack spacers.
The SV4000 series is not compatible with the double-stack spacers.
Individual SUP and EXH spacers can be mounted either on the top or the bottom.

Note) SV2000/3000/4000 port size

| Series | Port size |
|---------------|-----------|
| SV2000 | 1/8 |
| SV3000 | |
| SV4000 | 1/4 |

Accessory

| Series | Round head combination screw | Gasket |
|---------------|------------------------------|--------------|
| SV1000 | SX3000-22-9 (M2 x 39.5) | SX3000-57-4 |
| SV2000 | SV2000-21-6 (M3 x 46) | SY5000-11-15 |
| SV3000 | SV3000-21-3 (M4 x 53) | SY7000-11-11 |
| SV4000 | SV2000-21-5 (M3 x 60) | SY9000-11-2 |

■ Individual SUP/EXH spacer assembly (Double-stack)

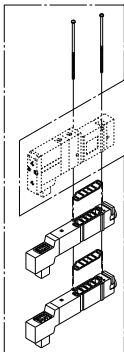

Single Valve/Sub-plate Type IP67 Compliant SV1000/2000/3000/4000 Series



How to Order

SV 1 1 00 - 5 W1 U D - - -

Series

| | |
|---|--------|
| 1 | SV1000 |
| 2 | SV2000 |
| 3 | SV3000 |
| 4 | SV4000 |

Made to order

| | |
|-----|--|
| Nil | — |
| X90 | Main valve fluororubber (Refer to page 134.) |

Type of actuation

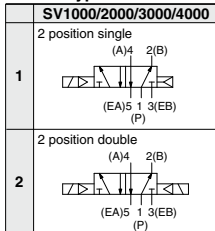

Pilot type

| | |
|-----|----------------|
| Nil | Internal pilot |
| R | External pilot |

* External pilot specifications is not available for 4 position dual 3 port valves.

Thread type

| | |
|-----|------|
| Nil | Rc |
| F | G |
| N | NPT |
| T | NPTF |

Port size

| Symbol | Port size | Applicable series |
|--------|-------------------|-------------------|
| Nil | Without sub-plate | |
| 01 | 1/8 | SV1000 |
| 02 | 1/4 | SV2000 SV3000 |
| 03 | 3/8 | SV3000 SV4000 |
| 04 | 1/2 | SV4000 |

Manual override

| | |
|-----|--------------------------------|
| Nil | Non-locking push type |
| D | Push-turn locking slotted type |

Light/Surge voltage suppressor

| | |
|---|-------------------------------------|
| U | With light/surge voltage suppressor |
| R | With surge voltage suppressor |

M12 waterproof connector

| Symbol | Cable length (mm) |
|--------|-------------------|
| W1 | 300 |
| W2 | 500 |
| W3 | 1000 |
| W4 | 2000 |
| W7 | 5000 |

Rated voltage

| | |
|---|--------|
| 5 | 24 VDC |
| 6 | 12 VDC |

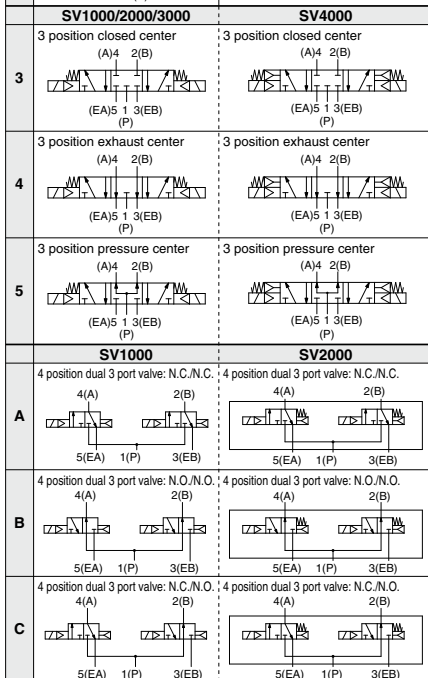

* SV3000 and 4000 are not available with 4 position dual 3 port valve.

SV Series Solenoid Valve Specifications



| | | |
|--|------------------------------|--|
| Fluid | | Air |
| Internal pilot operating pressure range (MPa) | 2 position single | 0.15 to 0.7 |
| | 4 position dual 3 port valve | |
| | 2 position double | 0.1 to 0.7 |
| External pilot operating pressure range (MPa) | 3 position | 0.2 to 0.7 |
| | Operating pressure range | -100 kPa to 0.7 |
| Ambient and fluid temperature (°C) | 2 position single, double | 0.25 to 0.7 |
| | 4 position dual 3 port valve | |
| | 3 position | -10 to 50 (No freezing) |
| Max. operating frequency (Hz) | 2 position single, double | 5 |
| | 4 position dual 3 port valve | |
| | 3 position | 3 |
| Manual override | | Non-locking push type |
| | | Push-turn locking slotted type |
| Pilot exhaust method | Internal pilot | Common exhaust type for main and pilot valve |
| | External pilot | |
| Lubrication | | Not required |
| Mounting orientation | | Unrestricted |
| Impact/Vibration resistance (ms²) | | 150/30 (8.3 to 2000 Hz) |
| Enclosure | | IP67 (Based on IEC60529) |
| Electrical entry | | M12 waterproof connector |
| Coil rated voltage | | 24 VDC, 12 VDC |
| Allowable voltage fluctuation | | ±10% of rated voltage |
| Power consumption (W) | | 0.6 (With indicator light: 0.65) |
| Surge voltage suppressor | | Zener diode |
| Indicator light | | LED |

Note) Impact resistance: No malfunction occurred when it is tested with a drop tester in the axial direction and at the right angles to the main valve and armature in both energized and de-energized states every once for each condition. (Values at the initial period)

Vibration resistance: No malfunction occurred in a one-sweep test between 45 and 2000 Hz. Test was performed at both energized and de-energized states in the axial direction and at the right angles to the main valve and armature. (Values at the initial period)

Response Time

| Type of actuation | Response time (ms) (at the pressure of 0.5 MPa) | | | |
|------------------------------|---|------------|------------|------------|
| | SV1000 | SV2000 | SV3000 | SV4000 |
| 2 position single | 11 or less | 25 or less | 28 or less | 40 or less |
| 2 position double | 10 or less | 17 or less | 26 or less | 40 or less |
| 3 position | 18 or less | 29 or less | 32 or less | 82 or less |
| 4 position dual 3 port valve | 15 or less | 33 or less | — | — |

Note) Based on dynamic performance test, JIS B 8375-1981. (Coil temperature: 20°C, at rated voltage)

M12 Waterproof Connector Wiring Specifications

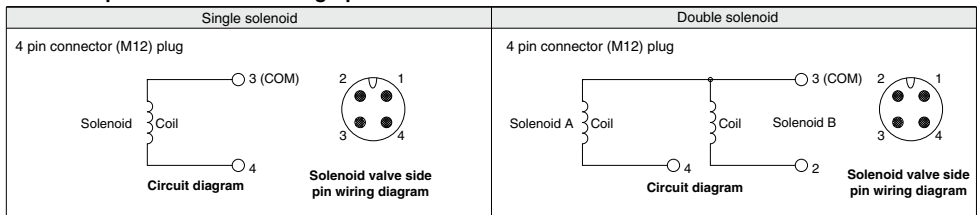

Note) Solenoid valves have no polarity.

Connection Destination (Female Side) Connector Cable

| Connector size | pin | Manufacturer | Applicable series |
|----------------|-----|---------------------------|-------------------|
| M12 | 4 | Correns Corp. | VA-4D |
| | | OMRON Corp. | XS2 |
| | | Azbil Corp. | PA5-41 |
| | | HIROSE ELECTRIC CO., LTD. | HR24 |
| | | DDK Ltd. | CM01-8DP4S |

* This connector is a female connector for ① relay output module and ② single unit/sub-plate.

Flow Rate Characteristics/Weight

SV1000 Series

| Valve model | Type of actuation | | Port size | Flow rate characteristics ⁽¹⁾ | | | | | | Weight (g) ⁽²⁾ |
|-------------|-------------------|-----------------|-----------|--|-------------|-------------|------------------------------|-------------|-------------|---|
| | | | | 1 → 4/2 (P → A/B) | | | 4/2 → 5/3 (A/B → EA/EB) | | | M12 waterproof connector (Cable length 300 mm) |
| | | | | C [dm ³ /(s·bar)] | b | Cv | C [dm ³ /(s·bar)] | b | Cv | |
| SV1□00-□-01 | 2 position | Single | Rc 1/8 | 1.0 | 0.30 | 0.24 | 1.1 | 0.30 | 0.26 | 123 (88) |
| | | Double | | | | | | | | 128 (93) |
| | 3 position | Closed center | | 0.77 | 0.28 | 0.18 | 0.85 | 0.30 | 0.19 | 130 (95) |
| | | Exhaust center | | 0.73 | 0.31 | 0.18 | 1.1 [0.55] | 0.26 [0.52] | 0.24 [0.16] | |
| | | Pressure center | | 1.2 [0.51] | 0.24 [0.45] | 0.29 [0.14] | 0.89 | 0.47 | 0.24 | |
| | 4 position dual | N.C./N.C. | | 0.68 | 0.35 | 0.18 | 1.1 | 0.39 | 0.29 | 128 (93) |
| | | N.O./N.O. | | 0.87 | 0.31 | 0.23 | 0.77 | 0.44 | 0.21 | |

Note 1) []: Denotes the normal position. Note 2) (): Denotes without sub-plate.

SV2000 Series

| Valve model | Type of actuation | | Port size | Flow rate characteristics ⁽¹⁾ | | | | | | Weight (g) ⁽²⁾ |
|-------------|-------------------|-----------------|-----------|--|-------------|-------------|------------------------------|-------------|-------------|---|
| | | | | 1 → 4/2 (P → A/B) | | | 4/2 → 5/3 (A/B → EA/EB) | | | M12 waterproof connector (Cable length 300 mm) |
| | | | | C [dm ³ /(s·bar)] | b | Cv | C [dm ³ /(s·bar)] | b | Cv | |
| SV2□00-□-02 | 2 position | Single | Rc 1/4 | 2.4 | 0.41 | 0.64 | 2.8 | 0.29 | 0.66 | 159 (96) |
| | | Double | | | | | | | | 163 (100) |
| | 3 position | Closed center | | 1.8 | 0.47 | 0.50 | 1.8 | 0.40 | 0.47 | 168 (105) |
| | | Exhaust center | | 1.4 | 0.55 | 0.44 | 3.0 [1.2] | 0.33 [0.48] | 0.72 [0.37] | |
| | | Pressure center | | 3.3 [0.84] | 0.36 [0.60] | 0.85 [0.28] | 1.8 | 0.40 | 0.48 | |
| | 4 position dual | N.C./N.C. | | 2.2 | 0.40 | 0.55 | 2.6 | 0.31 | 0.60 | 163 (100) |
| | | N.O./N.O. | | 2.7 | 0.24 | 0.57 | 2.3 | 0.36 | 0.54 | |

Note 1) []: Denotes the normal position. Note 2) (): Denotes without sub-plate.

SV3000 Series

| Valve model | Type of actuation | | Port size | Flow rate characteristics ⁽¹⁾ | | | | | | Weight (g) ⁽²⁾ |
|-------------|-------------------|-----------------|-----------|--|-------------|------------|------------------------------|-------------|------------|---|
| | | | | 1 → 4/2 (P → A/B) | | | 4/2 → 5/3 (A/B → EA/EB) | | | M12 waterproof connector (Cable length 300 mm) |
| | | | | C [dm ³ /(s·bar)] | b | Cv | C [dm ³ /(s·bar)] | b | Cv | |
| SV3□00-□-02 | 2 position | Single | Rc 1/4 | 4.1 | 0.41 | 1.1 | 4.1 | 0.29 | 1.0 | 250 (121) |
| | | Double | | | | | | | | 253 (124) |
| | 3 position | Closed center | | 3.0 | 0.43 | 0.80 | 2.6 | 0.41 | 0.72 | 26 (132) |
| | | Exhaust center | | 2.6 | 0.42 | 0.71 | 4.7 [1.7] | 0.35 [0.48] | 1.1 [0.49] | |
| | | Pressure center | | 5.3 [2.3] | 0.39 [0.49] | 1.3 [0.65] | 2.2 | 0.49 | 0.63 | |
| SV3□00-□-03 | 2 position | Single | Rc 3/8 | 4.9 | 0.29 | 1.2 | 4.5 | 0.27 | 1.1 | 235 |
| | | Double | | | | | | | | 238 |
| | 3 position | Closed center | | 3.0 | 0.40 | 0.80 | 2.6 | 0.45 | 0.73 | 246 |
| | | Exhaust center | | 2.6 | 0.42 | 0.71 | 4.8 [1.7] | 0.35 [0.48] | 1.1 [0.34] | |
| | | Pressure center | | 5.3 [2.3] | 0.31 [0.51] | 1.3 [0.64] | 2.3 | 0.45 | 0.66 | |

Note 1) []: Denotes the normal position. Note 2) (): Denotes without sub-plate.

SV4000 Series

| Valve model | Type of actuation | | Port size | Flow rate characteristics ⁽¹⁾ | | | | | | Weight (g) ⁽²⁾ |
|-------------|-------------------|-----------------|-----------|--|-------------|------------|------------------------------|-------------|------------|---|
| | | | | 1 → 4/2 (P → A/B) | | | 4/2 → 5/3 (A/B → EA/EB) | | | M12 waterproof connector (Cable length 300 mm) |
| | | | | C [dm ³ /(s·bar)] | b | Cv | C [dm ³ /(s·bar)] | b | Cv | |
| SV4□00-□-03 | 2 position | Single | Rc 3/8 | 7.9 | 0.34 | 2.0 | 9.6 | 0.43 | 2.5 | 505 (208) |
| | | Double | | | | | | | | 509 (212) |
| | 3 position | Closed center | | 7.5 | 0.33 | 1.8 | 7.3 | 0.30 | 1.7 | 530 (233) |
| | | Exhaust center | | 7.2 | 0.34 | 1.7 | 13 [4.0] | 0.23 [0.41] | 2.8 [0.95] | |
| | | Pressure center | | 12 [3.3] | 0.26 [0.41] | 2.8 [0.84] | 6.7 | 0.40 | 1.9 | |
| SV4□00-□-04 | 2 position | Single | Rc 1/2 | 8.0 | 0.48 | 2.2 | 10 | 0.29 | 2.5 | 484 |
| | | Double | | | | | | | | 488 |
| | 3 position | Closed center | | 7.6 | 0.32 | 1.8 | 7.3 | 0.32 | 1.8 | 509 |
| | | Exhaust center | | 7.3 | 0.42 | 2.0 | 13 [4.7] | 0.32 [0.54] | 3.6 [1.5] | |
| | | Pressure center | | 12 [3.3] | 0.33 [0.51] | 3.3 [0.94] | 7.4 | 0.33 | 1.9 | |

Note 1) []: Denotes the normal position. Note 2) (): Denotes without sub-plate.

Construction: SV1000/2000/3000/4000 Single Valve/Sub-plate Type

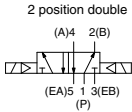
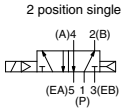

SV1000/2000/3000

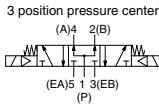
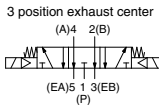
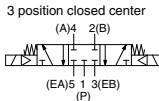

SV4000

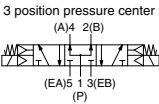
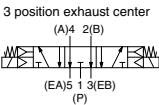
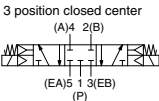

2 position single

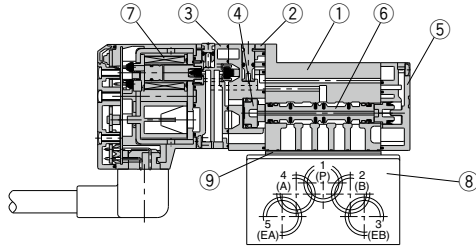

2 position double

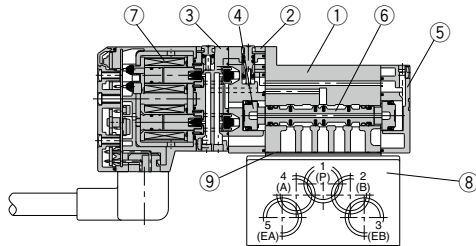

3 position closed center/exhaust center/pressure center

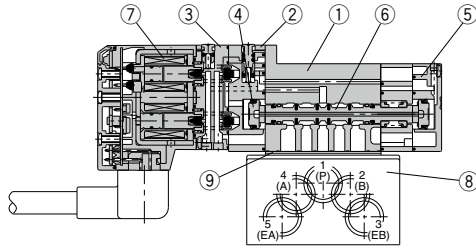

Component Parts

| No. | Description | Material | Note |
|-----|-----------------------------|--|-------|
| ① | Body | Aluminum die-casted (SV1000 is zinc die-casted) | White |
| ② | Adapter plate | Resin | White |
| ③ | Pilot body | Resin | White |
| ④ | Piston | Resin | — |
| ⑤ | End plate | Resin | White |
| ⑥ | Spool valve assembly | Aluminum/HNBR | — |
| ⑦ | Molded coil | — | Gray |

Caution

Mounting screw tightening torques

M2: 0.16 N·m
M3: 0.8 N·m
M4: 1.4 N·m

Replacement Parts

| No. | Description | Part no. | | | | Note |
|-----|-------------------------------------|--------------------------|--------------------------|--|--|---|
| | | SV1□00 | SV2□00 | SV3□00 | SV4□00 | |
| ⑧ | Sub-plate | SY3000-27-1□ | SY5000-27-1□ | 1/4: SY7000-27-1□ 3/8: SY7000-27-2□ | 3/8: SY9000-27-1□ 1/2: SY9000-27-2□ | Aluminum die-casted Refer to thread types on page 126 for □. |
| ⑨ | Gasket | SY3000-11-25 | SY5000-11-18 | SY7000-11-14 | SY9000-11-2 | |
| — | Round head combination screw | SX3000-22-2 (M2 x 24) | SV2000-21-1 (M3 x 30) | SV3000-21-1 (M4 x 35) | SV2000-21-2 (M3 x 40) | For valve mounting (Matt nickel plated) |

Note) Round head combination screw requires 2 pcs. per one valve for the SV1000, SV2000 and SV3000 series. For the SV4000 series, it requires 3 pcs.

SV Series

Dimensions: SV1000 Series

2 position single/double, 4 position dual 3 port [M12 waterproof connector type]

SV1□00(R)-□W□□-01□

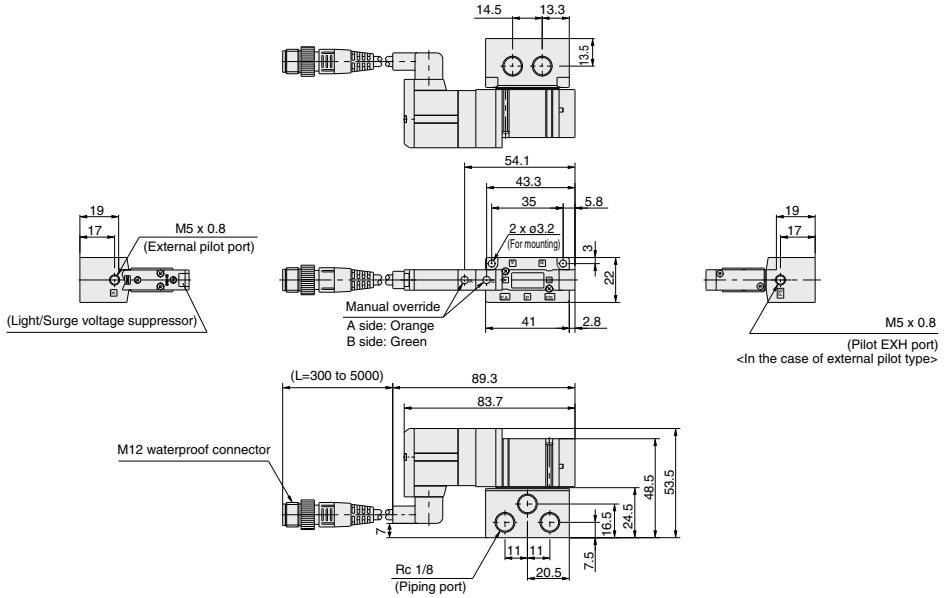

3 position closed center/exhaust center/pressure center [M12 waterproof connector type]

SV1□00(R)-□W□□-01□

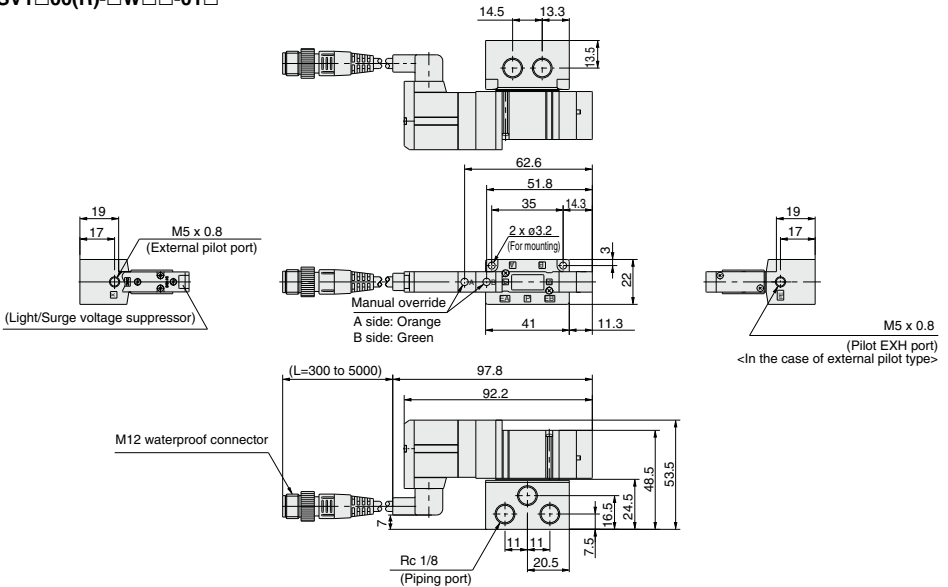

Dimensions: SV2000 Series

2 position single/double, 4 position dual 3 port [M12 waterproof connector type]
SV2□00(R)-□W□□-02□

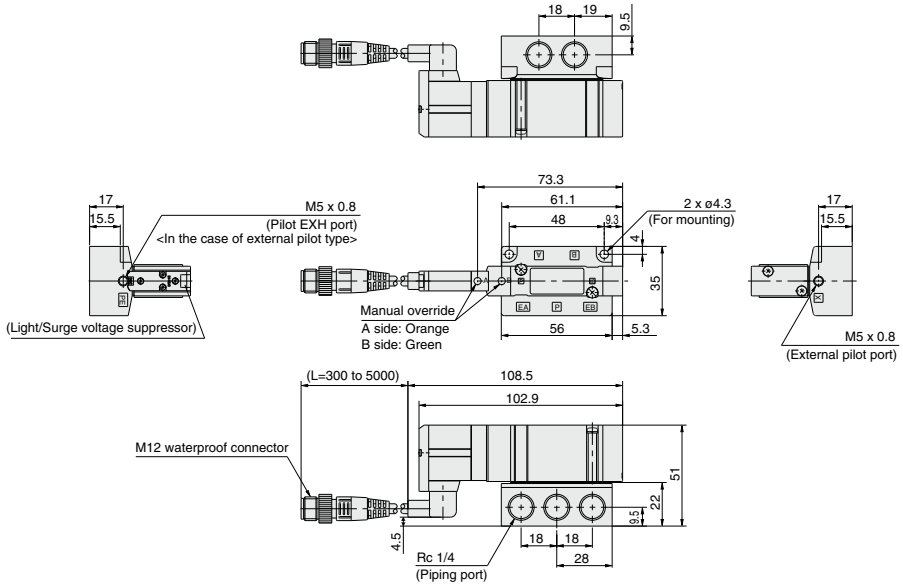

3 position closed center/exhaust center/pressure center [M12 waterproof connector type]
SV2□00(R)-□W□□-02□

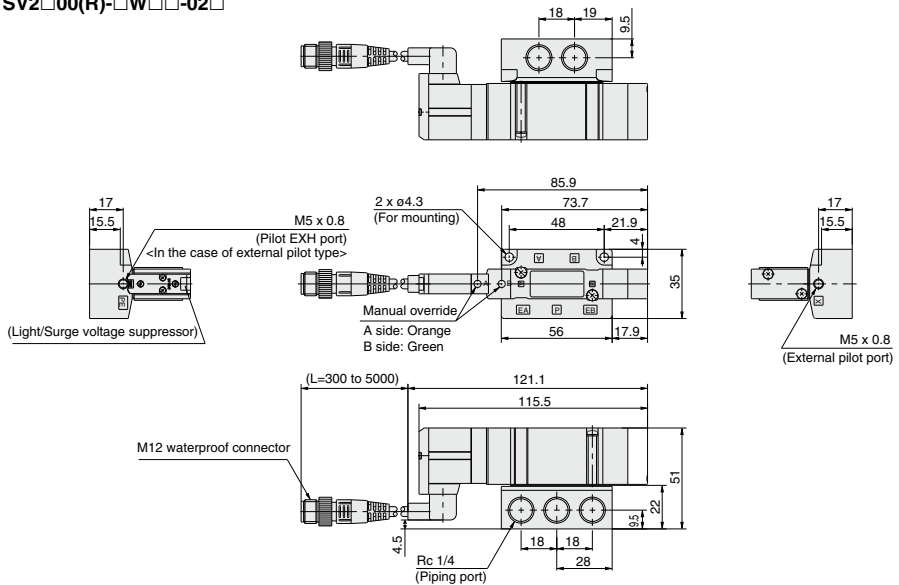

Dimensions: SV3000 Series

2 position single/double [M12 waterproof connector type]

SV3□00(R)-□W□□-02, 03□

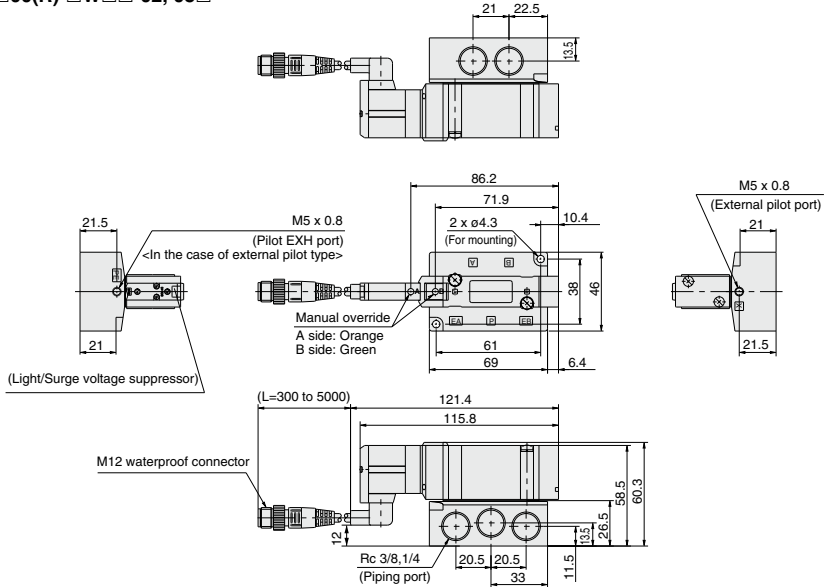

3 position closed center/exhaust center/pressure center [M12 waterproof connector type]

SV3□00(R)-□W□□-02, 03□

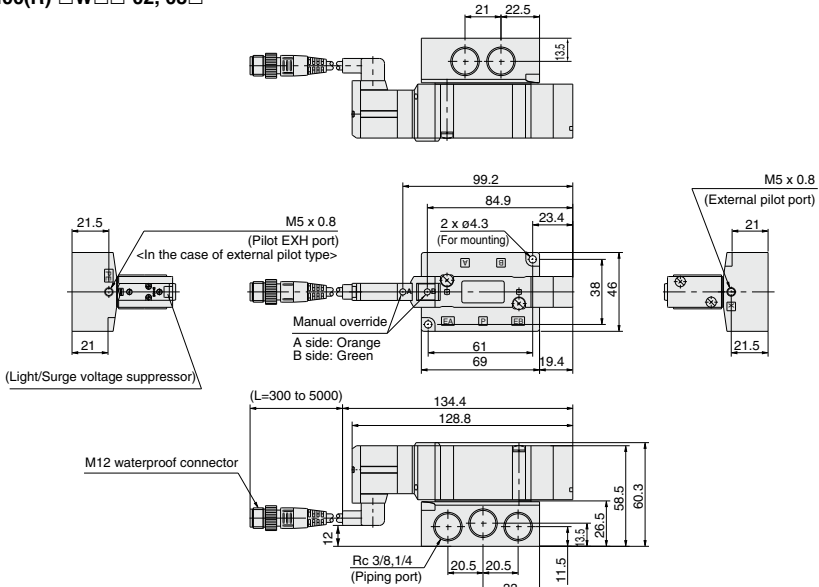

Dimensions: SV4000 Series

2 position single/double [M12 waterproof connector type]

SV4□00(R)-□W□□-03, 04□

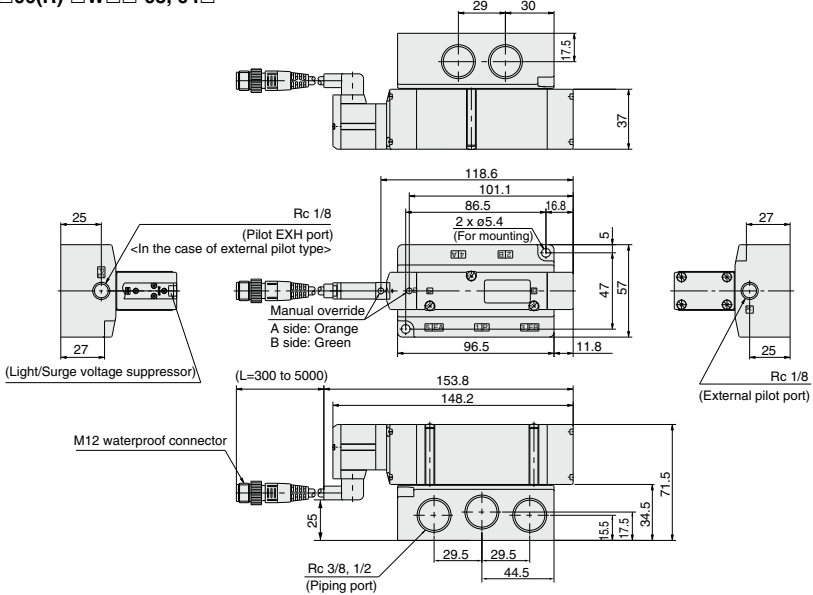

3 position closed center/exhaust center/pressure center [M12 waterproof connector type]

SV4□00(R)-□W□□-03, 04□

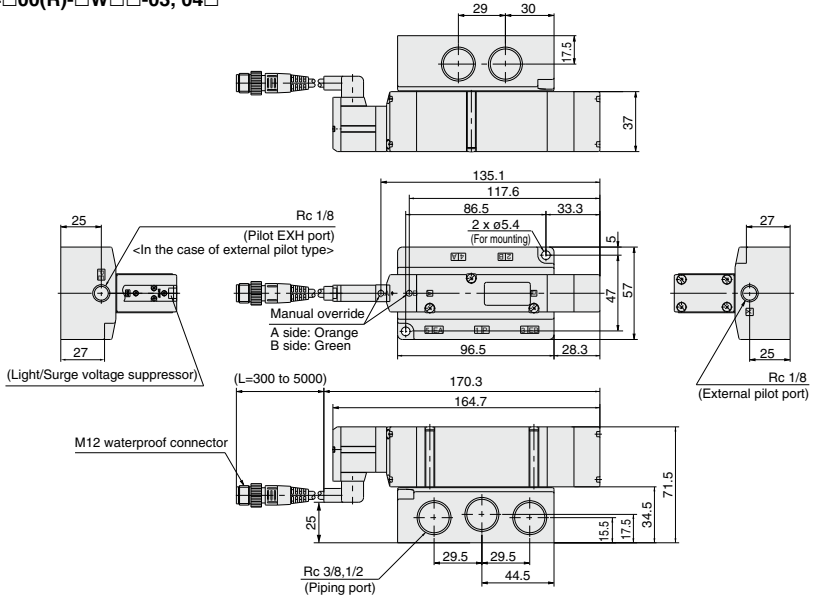



Please contact SMC for detailed dimensions, specifications and lead times.

1 Main Valve Fluororubber Specifications

Symbol
-X90

Fluororubber is used for rubber parts of the main valve to allow use in applications such as the following.

1. When using a lubricant other than the recommended turbine oil, and there is a possibility of malfunction due to swelling of the spool valve seats.
2. When ozone enters or is generated in the air supply.

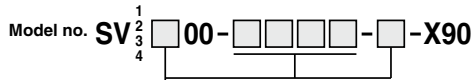

● Entry is the same as standard products.

Note) Because in the -X90 series fluororubber is used for only main valve, the rubber parts of the application/usage in conditions requiring heat resistance should be avoided.



SV Series

Specific Product Precautions 1

Be sure to read this before handling the products.

Refer to page 8 for safety instructions and pages 9 to 15 for 3/4/5 port solenoid valve precautions.

Environment

Warning

1. Do not use valves in atmospheres of corrosive gases, chemicals, salt water, water, steam, or where there is direct contact with any of these.
2. Products compliant with IP65 and IP67 enclosures (Based on IEC60529) are protected against dust and water, however, these products cannot be used in water.
3. Products compliant with IP65 and IP67 enclosures satisfy the specifications by mounting each product properly. Be sure to read the Specific Product Precautions for each product.
4. When using built-in silencer type manifold with an IP67 enclosure, keep the exhaust port of the silencer from coming in direct contact with water or other liquids. Liquid filtration through the exhaust port of the silencer can cause damage to the valve.

Manual Override Operation

Warning

Handle carefully, as connected equipment can be actuated through manual override operation.

Non-locking push type

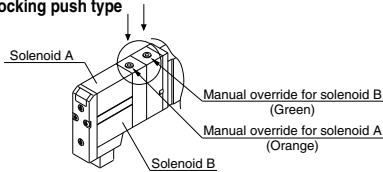

Push-turn locking slotted type

After pushing down, turn in the direction of the arrow. If it is not turned, it can be operated the same way as the non-locking type.

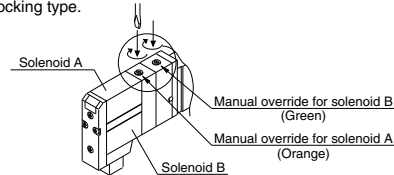

Caution

When locking the manual override with the push-turn locking slotted type, be sure to push it down before turning. Turning without first pushing it down can cause damage to the manual override and other trouble such as air leakage, etc.

Exhaust Restriction

Caution

Since Series SV is a type in which the pilot valve exhaust joins the main valve exhaust inside the valve, use caution, so that the piping from the exhaust port is not restricted.

SV Series Used as a 3 Port Valve

Caution

In the case of using a 5 port valve (as a 3 port valve)

The SV series can be used as normally closed (N.C.) or normally open (N.O.) 3 port valves by closing one of the cylinder ports (A or B) with a plug. However, they should be used with the exhaust ports kept open. They are convenient at times when a double solenoid type 3 port valve is required.

| Plug position | | B port | A port |
|---------------------|--------|--------|--------|
| Actuation | | N.C. | N.O. |
| Number of solenoids | Single | | |
| | Double | | |

Light/Surge Voltage Suppressor

Caution

Solenoid valves have no polarity. Light/Surge voltage suppressor

Single solenoid

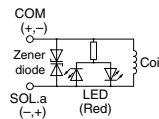

Double solenoid, 3 position type

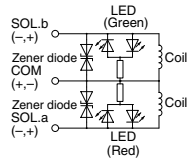

Surge voltage suppressor

Single solenoid

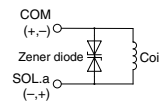

Double solenoid, 3 position type

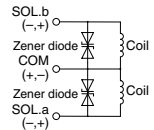

Light Indication

Caution

When equipped with indicator light and surge voltage suppressor, the light window turns red when solenoid A is energized, and it turns green when solenoid B is energized.

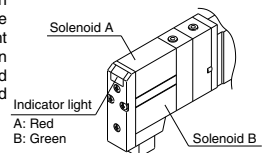



SV Series

Specific Product Precautions 2

Be sure to read this before handling the products.

Refer to page 8 for safety instructions and pages 9 to 15 for 3/4/5 port solenoid valve precautions.

Connector Entry Directions

⚠ Caution

Connector entry directions for D-sub connectors and flat ribbon cables can be changed. To change the connector's entry direction, press the levers on both sides of the connector, take it off, and change the direction as shown in the drawing. Since lead wire assemblies are attached to the connector, excessive pulling or twisting can cause broken wires or other trouble. Also, take precautions so that lead wires are not caught and pinched when installing the connector.

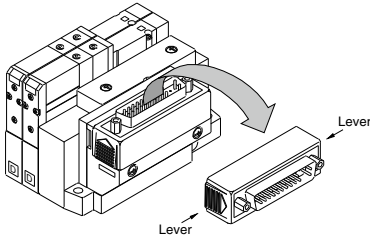

Manifold Mounting

⚠ Caution

There will be slight variations in the width of manifold blocks due to tolerance for the stacking manifold type. As the manifold is made up of a combination of manifold blocks, there will be an error due to accumulated tolerance between the actual pitch dimensions of the mounting holes used to secure the manifold and the values stated in the catalog. Keep this in mind when increasing the number of stations.

Manifold Block Width Tolerance Chart

| Series | Block width tolerance |
|---------------------|-----------------------|
| SS5V1-(W)10□ series | ±0.15 mm |
| SS5V2-(W)10□ series | ±0.2 mm |
| SS5V3-(W)10□ series | ±0.15 mm |
| SS5V4-(W)10□ series | ±0.15 mm |

How to Order Manifold

⚠ Caution

The letter "S" or "D" is indicated on manifold blocks for the SV series as shown below. This indication refers to the type of substrate assembly (single wiring or double wiring) inside the manifold blocks. When the manifold specification sheet does not include a wiring specification, all stations will be double wiring specification (D). In this case, single and double solenoid valves can be mounted in any position, but when a single valve is used, there will be an unused control signal. To avoid this, indicate positions of manifold blocks for a single wiring specification (S) and double wiring specification (D) on a manifold specification sheet. (Note that double, 3 or 4 position valves cannot be used for manifolds blocks with single wiring specification (S).)

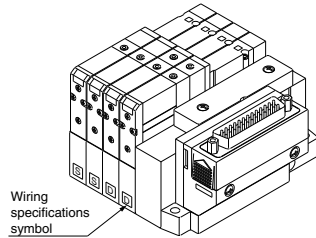

Substrate Assemblies inside Manifolds

⚠ Caution

Substrate assemblies inside of manifolds cannot be taken apart. Attempting to do so may damage parts.

One-touch Fittings

⚠ Caution

1. Tube attachment/detachment for One-touch fittings

1) Attaching of tube

- (1) Take a tube having no flaws on its periphery and cut it off at a right angle. When cutting the tube, use tube cutters TK-1, 2 or 3. Do not use pinchers, nippers or scissors, etc. If cutting is done with tools other than tube cutters, there is the danger that the tube may be cut diagonally or become flattened, etc., making a secure installation impossible, and causing problems such as the tube pulling out after installation or air leakage. Also allow some extra length in the tube.
- (2) Grasp the tube and push it in slowly, inserting it securely all the way into the fitting.
- (3) After inserting the tube, pull on it lightly to confirm that it will not come out. If it is not installed securely all the way into the fitting, this can cause problems such as air leakage or the tube pulling out.

2) Detaching of tube

- (1) Push in the release button sufficiently, and push the collar evenly at the same time.
- (2) Pull out the tube while holding down the release button so that it does not come out. If the release button is not pressed down sufficiently, there will be increased bite on the tube and it will become more difficult to pull it out.
- (3) When the removed tube is to be used again, cut off the portion which has been chewed before reusing it. If the chewed portion of the tube is used as is, this can cause trouble such as air leakage or difficulty in removing the tube.



SV Series

Specific Product Precautions 3

Be sure to read this before handling the products.

Refer to page 8 for safety instructions and pages 9 to 15 for 3/4/5 port solenoid valve precautions.

Other Tubing Brands

Caution

1. When using tube other than SMC brand, confirm that the following specifications are satisfied with respect to the outside diameter tolerance of the tube.

- | | |
|------------------------|---------------------------------------|
| 1) Nylon tubing | within ± 0.1 mm |
| 2) Soft nylon tubing | within ± 0.1 mm |
| 3) Polyurethane tubing | within $+0.15$ mm within -0.2 mm |

Do not use tubing which does not meet these outside diameter tolerances. It may not be possible to connect them, or they may cause other trouble, such as air leakage or the tube pulling out after connection.

Back Pressure Check Valve Built-in Type

Caution

1. Valves with built-in back pressure check valve is to protect the back pressure inside a valve. For this reason, use caution the valves with external pilot specification cannot be pressurized from exhaust port [3/5(E)]. As compared with the types which do not integrate the back pressure check valve, C value of the flow rate characteristics goes down. For details, please contact SMC.
2. Do not switch valves when A or B port is open to the atmosphere, or while the actuators and air operated equipment are in operation. The back pressure prevention seal may be peeled off, which may cause air leakage or malfunctions. Use caution especially when performing a trial operation or maintenance work.



SV Series

Specific Product Precautions 4

Be sure to read this before handling the products.

Refer to page 8 for safety instructions and pages 9 to 15 for 3/4/5 port solenoid valve precautions.

Interface Regulator

Caution

Specifications

| Interface regulator | SV1□00-□-□ | SV2000-□-□ | SV3000-□-□ | SV4000-□-□ | |
|----------------------------|------------------------|-----------------|------------|------------|---------|
| Applicable model | SV1000 | SV2000 | SV3000 | SV4000 | |
| Regulating port | P, A, B | | | | |
| Set pressure range | 0.1 to 0.7 MPa | | | | |
| Maximum operating pressure | 0.7 MPa | | | | |
| Fluid | Air | | | | |
| Ambient and fluid temp. | Maximum at 50°C | | | | |
| Weight | With pressure gauge | 38.4 g (43.4 g) | 86.5 g | 103.8 g | 178.2 g |
| | Without pressure gauge | 32 g (37 g) | 80.3 g | 97.6 g | 171.8 g |

Note 1) Apply pressure from P port in the base for interface regulator.

Note 2) P port pressure regulation is only available for closed center, pressure center and 4-position dual 3-port valve.

Note 3) Gasket and mounting screws are included in the weight.

Note 4) () : Denotes the values of SV1300.

Flow Rate Characteristics

SV1000 P Reduced pressure (P → A,B)

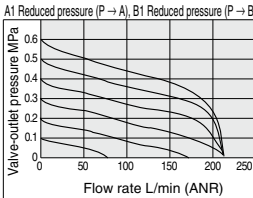
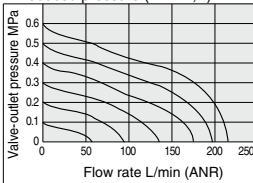

SV2000 P Reduced pressure (P → A,B)

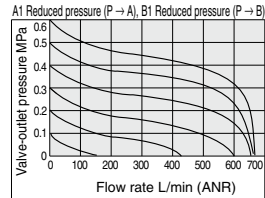
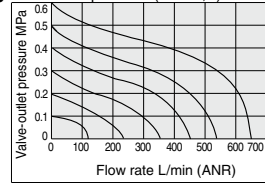

SV3000 P Reduced pressure (P → A,B)

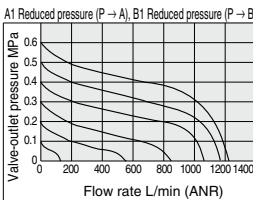
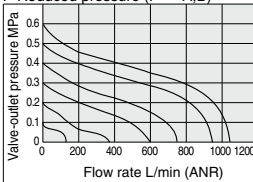

How to Calculate the Flow Rate

For obtaining the flow rate, refer to the [Web Catalog](#).



SV Series

Specific Product Precautions 5

Be sure to read this before handling the products.

Refer to page 8 for safety instructions and pages 9 to 15 for 3/4/5 port solenoid valve precautions.

Serial Wiring EX500/EX250/EX260/EX120 Precautions

Warning

- These products are intended for use in general factory automation equipment.
Avoid using these products in machinery/equipment which affects human safety, and in cases where malfunction or failure can result in extensive damage.
- Do not use in an explosive atmosphere, environment with inflammable gases, or corrosive atmosphere.
This can cause injury or fire, etc.
- Work such as transporting, installing, piping, wiring, operation, control and maintenance should be performed by personnel with specialized knowledge.
There is a danger of electrocution, injury or fire, etc.
- Install an external emergency stop circuit that can promptly stop operation and shut off the power supply.
- Do not remodel these products, as there is a danger of injury and damage.
- Do not wipe the product with chemicals, etc.

Caution

- Read the operation manual carefully, strictly observe the precautions and operate within the range of the specifications.
- Do not drop these products or submit them to strong impacts. This can cause damage, failure or malfunction, etc.
- In locations with poor electrical conditions, take steps to ensure a steady flow of the rated power supply. Use of a voltage outside of the specifications can cause malfunction, damage to the unit, electrocution or fire, etc.
- Do not touch connector terminals or internal substrates when current is being supplied. There is a danger of malfunction, damage to the unit or electrocution if connector terminals or internal substrates are touched when current is being supplied.
Be sure that the power supply is OFF when adding or removing manifold valves or input blocks, etc., or when connecting or disconnecting connectors.
- Operate at an ambient temperature that is within the specifications. Even when the ambient temperature range is within the specifications, do not use in locations where there are rapid temperature changes.
- Keep wire scraps and other extraneous material from getting inside these products. This can cause fire, failure or malfunction, etc.
- Give consideration to the operating environment depending on the type of enclosure being used.
To achieve IP65 or IP67 protection, provide appropriate wiring between all units using electrical wiring cables, communication connectors and cables with M12 connectors. Also, provide waterproof caps when there are unused ports, and perform proper mounting of input units, input blocks, SI units and manifold valves, etc. Provide a cover or other protection for applications in which there is constant exposure to water.
- Obey the proper tightening torque.
There is a possibility of damaging threads if tightening exceeds the tightening torque range.
- Provide adequate protection when operating in locations such as the following:
 - Where noise is generated by static electricity, etc.
 - Where there is a strong electric field
 - Where there is a danger of exposure to radiation
 - When in close proximity to power supply lines

Caution

- When these products are installed in equipment, provide adequate protection against noise by using noise filters, etc.
- Since these products are components that are used after installation in other equipment, the customer should confirm conformity to EMC directives for the finished product.
- Do not remove the name plate.
- Perform periodic inspections and confirm normal operation. It may otherwise be impossible to guarantee safety due to unexpected malfunction or erroneous operation.
- Do not use in places where there are cyclic temperature changes.
In case that the cyclic temperature is beyond normal temperature changes, the inside the product is likely to be adversely effected.
- Do not use in direct sunlight.
Do not use in direct sunlight. It may cause malfunction or damage.
- Do not use in places where there is radiated heat around it.
Such a place is likely to cause malfunction.

Power Supply Safety Instructions

Caution

- Operation is possible with a single power supply or a separate power supply. However, be sure to provide two wiring systems (one for solenoid valves, and one for input and control units).
- Use the following UL approved products for DC power supply combinations.
 - Controlled voltage current circuit conforming to UL508
Circuit uses the secondary coil of an isolated transformer as the power supply, satisfying the following conditions.
 - Max. voltage (with no load): 30 Vrms (42.4 V peak) or less
 - Max. current: (1) 8 A or less (including shorts), and (2) When controlled by a circuit protector (fuse, etc.) with the following rating

| No-load voltage (V peak) | Max. current rating |
|--------------------------|---------------------|
| 0 to 20 [V] | 5.0 |
| Over 20 [V] to 30 [V] | 100 |
| | Peak voltage value |

- A circuit (class 2 circuit) with maximum 30 Vrms (42.4 V peak) or less, and a power supply consisting of a class 2 power supply unit conforming to UL1310, or a class 2 transformer conforming to UL1585

Safety Instructions for Cable

Caution

- Be careful of mis-wiring. This can cause malfunction, damage and fire in the unit.
- To prevent noise and surge in signal lines, keep all wiring separate from power lines and high voltage lines. Otherwise, this can cause malfunction.
- Check wiring insulation, as defective insulation can cause damage to the unit due to excessive voltage or current.
- Do not bend or pull cables repeatedly, and do not place heavy objects on them or allow them to be pinched. This can cause broken lines.



SV Series

Specific Product Precautions 6

Be sure to read this before handling the products.

Refer to page 8 for safety instructions and pages 9 to 15 for 3/4/5 port solenoid valve precautions.

EX600 Precautions

Design/Selection

Warning

- Use this product within the specification range.**
Using beyond the specified specifications range can cause fire, malfunction, or damage to the system. Confirm the specifications when operating.
- When using for an interlock circuit:**
 - Provide a multiple interlock system which is operated by another system (such as mechanical protection function).
 - Perform an inspection to check that it is working properly.

This may cause possible injury due to malfunction.

Caution

- When applicable to UL, use a Class 2 power supply unit conforming to UL1310 for direct current power supply.**
- Use this product within the specified voltage range.**
Using beyond the specified voltage range is likely to cause the units and connecting devices to be damaged or to malfunction.
- The power supply for the unit should be 0 V as the standard for both power supply for output as well as power supply for control/input.**

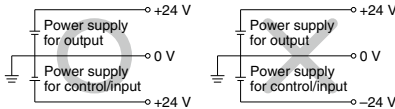

- Do not install a unit in a place where it can be used as a foothold.**
Applying any excessive load such as stepping on the unit by mistake or placing a foot on it, will cause it to break.
- Keep the surrounding space free for maintenance.**
When designing a system, take into consideration the amount of free space needed for performing maintenance.
- Do not remove the name plate.**
Improper maintenance or incorrect use of operation manual can cause failure and malfunction. Also, there is a risk of losing conformity with safety standards.
- Beware of inrush current when the power supply is turned on.**
Some connected loads can apply an initial charge current which will trigger the over current protection function, causing the unit to malfunction.

Mounting

Caution

- When handling and assembling units:**
 - Do not touch the sharp metal parts of the connector or plug.
 - Do not apply excessive force to the unit when disassembling.
The connecting portions of the unit are firmly joined with seals.
 - When joining units, take care not to get fingers caught between units.
Injury can result.

Mounting

Caution

- Do not drop, bump, or apply excessive impact.**
Otherwise, the unit can become damaged, malfunction, or fail to function.
- Observe the tightening torque range.**
Tightening outside of the allowable torque range will likely damage the screw.
IP67 cannot be guaranteed if the screws are not tightened to the specified torque.
- When lifting a large size manifold solenoid valve unit, take care to avoid causing stress to the valve connection joint.**
The connection parts of the unit may be damaged. Because the unit may be heavy, carrying and installation should be performed by more than one operator to avoid strain or injury.
- When placing a manifold, mount it on a flat surface.**
Torsion in the whole manifold can lead to trouble such as air leakage or defective insulation.

Wiring

Caution

- Confirm grounding to maintain the safety of the reduced wiring system and for anti-noise performance.**
Provide a specific grounding as close to the unit as possible to minimize the distance to grounding.
- Avoid repeatedly bending or stretching the cable and applying a heavy object or force to it.**
Wiring applying repeated bending and tensile stress to the cable can break the circuit.
- Avoid miswiring.**
If miswired, there is a danger of malfunction or damage to the reduced wiring system.
- Do not wire while energizing the product.**
There is a danger of malfunction or damage to the reduced wiring system or input/output equipment.
- Avoid wiring the power line and high pressure line in parallel.**
Noise or surge produced by signal line resulting from the power line or high pressure line could cause malfunction. Wiring of the reduced wiring system or input/output device and the power line or high pressure line should be separated from each other.
- Confirm the wiring insulation.**
Defective insulation (contact with other circuits, improper insulation between terminals, etc.) may cause damage to the reduced wiring system or input/output device due to excessive voltage or current.



SV Series

Specific Product Precautions 7

Be sure to read this before handling the products.

Refer to page 8 for safety instructions and pages 9 to 15 for 3/4/5 port solenoid valve precautions.

EX600 Precautions

Wiring

Caution

7. When a reduced wiring system is installed in machinery/equipment, provide adequate protection against noise by using noise filters, etc.
Noise in signal lines may cause malfunction.
8. When connecting wires of input/output device or Handheld Terminal, prevent water, solvent or oil from entering inside from the connector section.
This can cause damage, equipment failure or malfunction.
9. Avoid wiring patterns in which excessive stress is applied to the connector.
This may cause malfunction or damage to the unit due to contact failure.

Operating Environment

Warning

1. Do not use in an atmosphere containing an inflammable gas or explosive gas.
Use in such an atmosphere is likely to cause a fire or explosion. This system is not explosion-proof.

Caution

1. Select the proper type of enclosure according to the environment of operation.
IP65/67 is achieved when the following conditions are met.
 - 1) Provide appropriate wiring between all units using electrical wiring cables, communication connectors and cables with M12 connectors.
 - 2) Suitable mounting of each unit and manifold valve.
 - 3) Be sure to mount a seal cap on any unused connectors.If using in an environment that is exposed to water splashes, please take measures such as using a cover.
When the enclosure is IP40, do not use in an operating environment or atmosphere where it may come in contact with corrosive gas, chemical agents, seawater, water, or water vapor. When connected to EX600-D□□E or EX600-D□□F, manifold enclosure is IP40.
Also, the Handheld Terminal conforms to IP20, so prevent foreign matter from entering inside, and water, solvent or oil from coming in direct contact with it.
2. Provide adequate protection when operating in locations such as the following.
Failure to do so may cause damage or malfunction. The effect of countermeasures should be checked in individual equipment and machine.
 - 1) Where noise is generated by static electricity, etc.
 - 2) Where there is a strong electric field
 - 3) Where there is a danger of exposure to radiation
 - 4) When in close proximity to power supply lines

Operating Environment

Caution

3. Do not use in an environment where oil and chemicals are used.
Operating in environments with coolants, cleaning solvents, various oils or chemicals may cause adverse effects (damage, malfunction) to the unit even in a short period of time.
4. Do not use in an environment where the product could be exposed to corrosive gas or liquid.
This may damage the unit and cause it to malfunction.
5. Do not use in locations with sources of surge generation.
Installation of the unit in an area around the equipment (electromagnetic lifters, high frequency induction furnaces, welding machine, motors, etc.), which generates the large surge voltage could cause to deteriorate an internal circuitry element of the unit or result in damage. Implement countermeasures against the surge from the generating source, and avoid touching the lines with each other.
6. Use the product type that has an integrated surge absorption element when directly driving a load which generates surge voltage by relay, solenoid valves or lamp.
When a surge generating load is directly driven, the unit may be damaged.
7. The product is CE/UKCA marked, but not immune to lightning strikes. Take measures against lightning strikes in your system.
8. Keep dust, wire scraps and other extraneous material from getting inside the product.
This may cause malfunction or damage.
9. Mount the unit in such locations, where no vibration or shock is affected.
This may cause malfunction or damage.
10. Do not use in places where there are cyclic temperature changes.
In case that the cyclic temperature is beyond normal temperature changes, the internal unit is likely to be adversely effected.
11. Do not use in direct sunlight.
Do not use in direct sunlight. It may cause malfunction or damage.
12. Use this product within the specified ambient temperature range.
This may cause malfunction.
13. Do not use in places where there is radiated heat around it.
Such a place is likely to cause malfunction.



SV Series

Specific Product Precautions 8

Be sure to read this before handling the products.

Refer to page 8 for safety instructions and pages 9 to 15 for 3/4/5 port solenoid valve precautions.

EX600 Precautions

Adjustment/Operation

⚠ Warning

1. **Do not perform operation or setting with wet hands.**

There is a risk of electrical shock.

<Handheld Terminal>

2. **Do not apply pressure to the LCD.**

There is a possibility of the crack of LCD and injuring.

3. **The forced input/output function is used to change the signal status forcibly. When operating this function, be sure to check the safety of the surroundings and installation.**

Otherwise, injury or equipment damage could result.

4. **Incorrect setting of parameters can cause malfunction. Be sure to check the settings before use.**

This may cause injury or equipment damage.

⚠ Caution

1. **Use a watchmaker's screwdriver with thin blade for the setting of each switch of the SI Unit.**

When setting the switch, do not touch other unrelated parts.

This may cause parts damage or malfunction due to a short circuit.

2. **Provide adequate setting for the operating conditions.**

Failure to do so could result in malfunction.

Refer to the operation manual for setting of the switches.

3. **For the details of programming and address setting, refer to the manual from the PLC manufacturer.**

The content of programming related to protocol is designed by the manufacturer of the PLC used.

<Handheld Terminal>

4. **Do not press the setting buttons with a sharp pointed object.**

This may cause damage or malfunction.

5. **Do not apply excessive load and impact to the setting buttons.**

This may cause damage, equipment failure or malfunction.

When the order does not include the SI Unit, the Valve Plate to connect the manifold and SI Unit is not mounted. Use attached valve fixing screws and mount the Valve Plate.

(Tightening torque: 0.6 to 0.7 N·m)

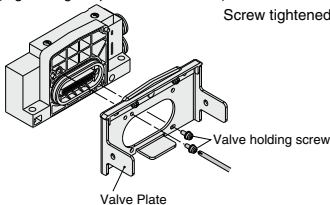

Maintenance

⚠ Warning

1. **Do not disassemble, modify (including circuit board replacement) or repair this product.**

Such actions are likely to cause injuries or breakage.

2. **When an inspection is performed,**

- **Turn off the power supply.**
- **Stop the air supply, exhaust the residual pressure in piping and verify that the air is released before performing maintenance work.**

Unexpected malfunction of system components and injury can result.

⚠ Caution

1. **When handling and replacing the unit:**

- **Do not touch the sharp metal parts of the connector or plug.**
- **Do not apply excessive force to the unit when disassembling.**

The connecting portions of the unit are firmly joined with seals.

- **When joining units, take care not to get fingers caught between units.**

Injury can result.

2. **Perform periodic inspection.**

Unexpected malfunction in the system composition devices is likely to occur due to malfunction of machinery or equipment.

3. **After maintenance, make sure to perform an appropriate functionality inspection.**

In cases of abnormality such as faulty operation, stop operation. Unexpected malfunction in the system composition devices is likely to occur.

4. **Do not use benzene and thinner for cleaning units.**

Damage to the surface or erasure of the display can result. Wipe off any stains with a soft cloth.

If the stain is persistent, wipe off with a cloth soaked in a dilute solution of neutral detergent and wrung out tightly, and then finish with a dry cloth.

Other

⚠ Caution

1. **Refer to the catalog of each series for Common Precautions and Specific Product Precautions on manifold solenoid valves.**

■ Trademark

DeviceNet® is a registered trademark of ODVA, Inc. EtherNet/IP® is a registered trademark of ODVA, Inc. CompoNet® is a registered trademark of ODVA, Inc. EtherCAT® is registered trademark and patented technology, licensed by Beckhoff Automation GmbH, Germany.