

# Fieldbus System (Output device for driving 5-port solenoid valves)

## EX260 Series

# Space-saving installation

Compact Approx.

28 mm



\* Only the SV and SV valves are UL-compliant.

- IO-Link compatible
- IP67
  - \* For units with a D-sub connector, and when connected to S0700 manifolds, it is IP40.
- Drives up to 32 solenoids
- Daisy-chain wiring communication

\* Excludes the units compatible with IO-Link

### <Compatible Protocols>



EtherNet/IP EtherCAT ETHERNET POWERLINK

Made to Order



CANopen

Please contact SMC for details on compatible products.

### Compliant with functional safety standards (PROFIsafe compatible)

- Product certification obtained by a third party (IEC 61508/62061 SIL 3, ISO 13849 PL e Cat. 3)
- Safety output for valve control

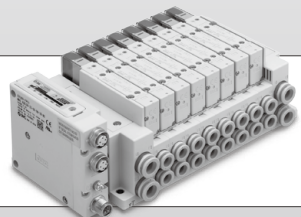

### Manifold length reduced by approx. 53 mm

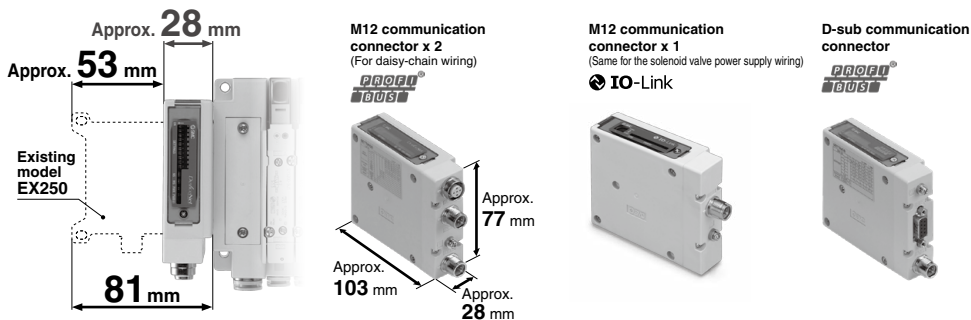

### Daisy-chain wiring communication is possible.\*1

A branch connector is not necessary/Reduced wiring space

\*1 Excludes the units compatible with IO-Link

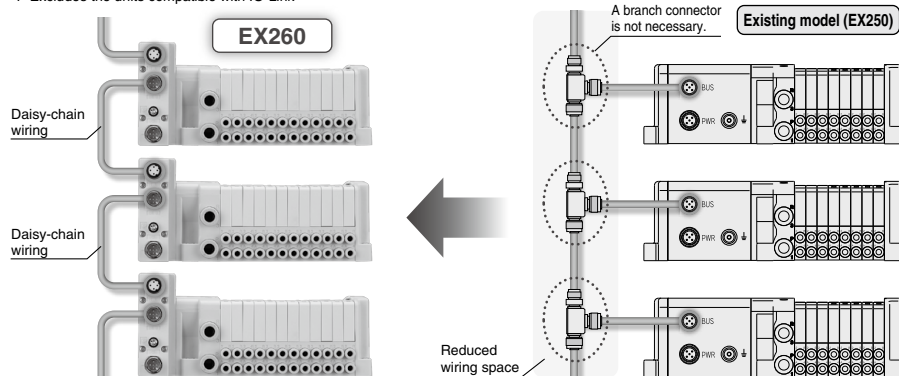

### Wiring and piping from the same direction is possible. (for side ported)

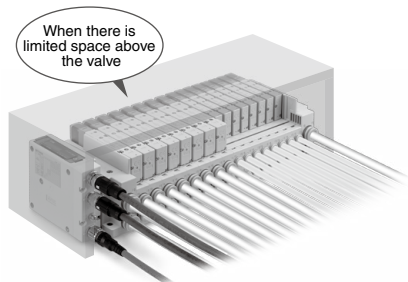





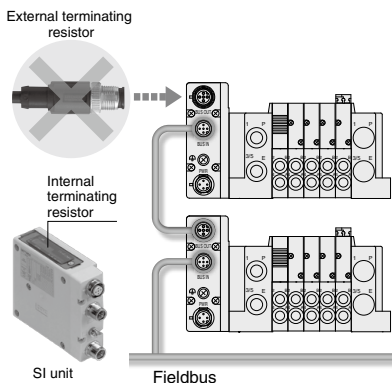

### An external terminating resistor is not necessary.

(Only available for M12 PROFIBUS DP, CC-Link communication connectors)























ON/OFF switching is possible with an internal terminating resistor.  
An external terminating resistor is not necessary.







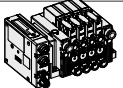



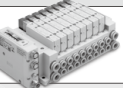

**Product Specification Variations**

		 DeviceNet	 CC-Link	 EtherNet/IP	 EtherCAT	 POWERLINK	 IO-Link	 PROFINET
Number of outputs	16	●	●	●	●	●	●	●
	32	●	●	●	●	●	●	●
Output polarity	PNP	●	●	●	●	●	●	●
	NPN	●	●	●	●	●	●	●
Communication connector	M12	●	●	●	●	●	●	●
	D-sub	●	●	●	●	●	●	●

**Applicable Valve Series and Compatible Protocols**

Fieldbusses & Industrial Ethernet		 DeviceNet	 CC-Link	 EtherNet/IP	 EtherCAT	 POWERLINK	 IO-Link		
Applicable valve	Flow rate characteristics (4/2 → 5/3)		Max. number of solenoids	Power consumption [W]	Applicable cylinder size				
	C [dm <sup>3</sup> /(s·bar)]	b							
 IP67*1 		SY3000	1.6	0.19	32	0.35 (Standard) 0.1 (With power-saving circuit)	ø50		
		SY5000	3.6	0.17			ø63		
		SY7000	5.9	0.20			ø80		
 IP67*1, *2 		JSY1000	0.91	0.48	32	0.2 (With power-saving circuit) 0.4 (Standard) 0.1 (With power-saving circuit)	ø40		
		JSY3000	2.77	0.27			ø50		
		JSY5000	6.59	0.22			ø80		
 IP40 		S0700*3	0.37	0.39	32	0.35	ø25		
 IP67*1 			SV1000*3	1.1	0.35	32	0.6	ø40	
	SV2000*3		2.4	0.18	ø63				
	SV3000*3		4.3	0.21	ø80				
 IP67*1 		VQC1000	1.0	0.30	24	0.4 (Standard) 0.95 (Standard) 0.4 (Low-wattage type)	ø40		
		VQC2000	3.2	0.30			ø63		
		VQC4000	7.3	0.38			ø160		
		VQC5000	17	0.31			ø180		
Applicable vacuum unit				ZK2□A	Nozzle diameter [mm]		16	0.4	-91
					0.7				
					1.0				
					1.2				
					1.5				

**Safety Communication**  The use of validated products may be required for valve manifolds used in the safety-related parts of equipment which is compliant with safety standard ISO 13849. For validated products, please contact your SMC sales representative.

Applicable valve	Flow rate characteristics (4/2 → 5/3)		Max. number of solenoids	Power consumption [W]	Applicable cylinder size		
	C [dm <sup>3</sup> /(s·bar)]	b					
 IP67 		SY3000	1.6	0.19	32	0.35 (Standard) 0.1 (With power-saving circuit)	ø50
		SY5000	3.6	0.17			ø63
		SY7000	5.9	0.20			ø80
 IP67*2 		JSY1000	0.91	0.48	32	0.2 (With power-saving circuit) 0.4 (Standard) 0.1 (With power-saving circuit)	ø40
		JSY3000	2.77	0.27			ø50
		JSY5000	6.59	0.22			ø80
 IP67 		VQC1000	1.0	0.30	24	0.4 (Standard) 0.95 (Standard) 0.4 (Low-wattage type)	ø40
		VQC2000	3.2	0.30			ø63
		VQC4000	7.3	0.38			ø160
		VQC5000	17	0.31			ø180

\*1 Units with a D-sub communication connector are IP40.  
 \*2 The JSY1000 is IP40.  
 \*3 There is no manifold part number setting for the IO-Link compatible SI units.

## IO-Link compatible

### Integratable with various existing networks

IO-Link devices can be easily connected to various networks via the IO-Link master, which acts as a gateway between IO-Link communication and various Fieldbuses.

Solenoid valves can be connected for communication without relying upon a Fieldbus or PLC.

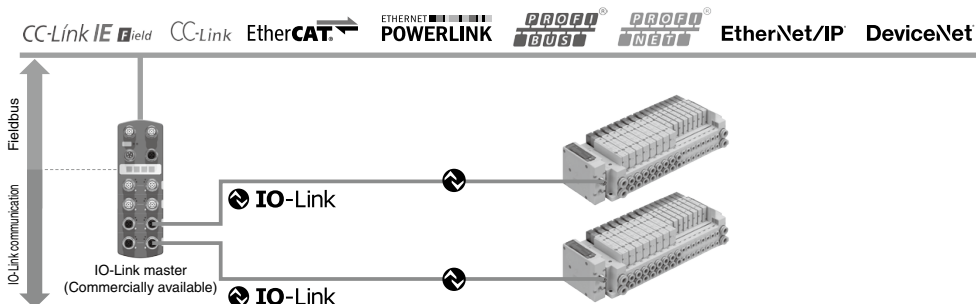

### Can be connected using a single general-purpose cable, resulting in a reduction in the space required for wiring

#### Port class B

IO-Link master  
(Commercially available)

- Connect the IO-Link master port to the device using a 1:1 configuration.
- Connect using an M12 round connector.
- Maximum cable length: 20 m
- Special communication cables are not necessary.
- In order to connect the SI unit using a single cable, use a port class B type IO-Link master.



Port class B compliant

#### Port class A

IO-Link master  
(Commercially available)

General-purpose 5-wire unshielded cables are used for connection.  
The signal wire and valve power supply wire can be connected with the same cable.

#### SI unit/Connector pin arrangement

Pin no.	SI unit port pin function (Port class B)
1	+24 V for control unit
2	+24 V for solenoid valve
3	0 V for control unit
4	IO-Link communication
5	0 V for solenoid valve

#### Y Branch Connector

#### Port class A compliant

A special wiring Y branch connector is available.



Used when connecting to a port class A type IO-Link master, which is often used when connecting to an IO-Link sensor

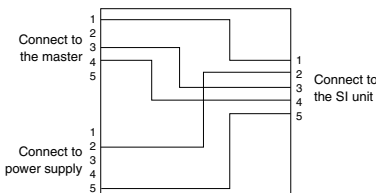

#### Difference between IO-Link master port class A and class B

Pin no.	IO-Link master port pin function	
	Port class A	Port class B
1	+24 V	+24 V
2	NC/DI/DO	Additional power supply +24 V
3	0 V	0 V
4	IO-Link/DI/DO	IO-Link/DI/DO
5	NC	Additional power supply 0 V



## Supports safety communication (PROFIsafe) <EX260-FPS1>



PROFIsafe is established as an international standard (IEC 61784-3-3). It is a communication protocol that transmits safety-related data by PROFINET communication and can be used up until safety standards ISO 13849-1 PL e and IEC 61508/IEC 62061 SIL 3.



PROFINET/PROFIsafe compatible PLC



PROFINET/PROFIsafe

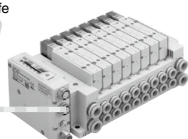

EX260-FPS1  
(PROFIsafe compatible SI unit)

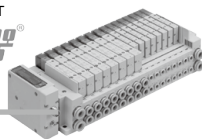

EX260-SPN□  
(PROFINET compatible SI unit)

A PROFIsafe compatible PLC allows for the use of a PROFINET compatible SI unit and a PROFIsafe compatible SI unit to be used on one communication line at the same time.

## Compliant with safety standards

This product (EX260-FPS1) is intended to facilitate safe machine and system designing (ISO/IEC standard compliance) and has been certified by a third party (TÜV Rheinland) for use up until the standards listed below.



IEC 61508/IEC 62061 SIL 3  
ISO 13849 PL e/Cat. 3

### · SIL (Safety Integrity Level)

A safety integrity level as defined by international standard IEC 61508/62061  
There are 4 levels of safety, with the lowest being SIL 1 and the highest being SIL 4.

### · PL (Performance Level)

A scale used to define the capability of safety-related parts to perform a safety function as defined by international standard ISO 13849  
There are 5 levels of safety function, with the lowest being PL a and the highest being PL e.

## Safety Output

This product (EX260-FPS1) has a safety switch inside the product. It shuts off the voltage supplied to the valve by turning OFF the safety switch via directive from the PLC to enter safe state. The safety switch of this product (EX260-FPS1) has two redundancies, one on the 24 V side and the other on the 0 V side. It continuously runs diagnostics. The safety switch is turned OFF in the event of an error detection.

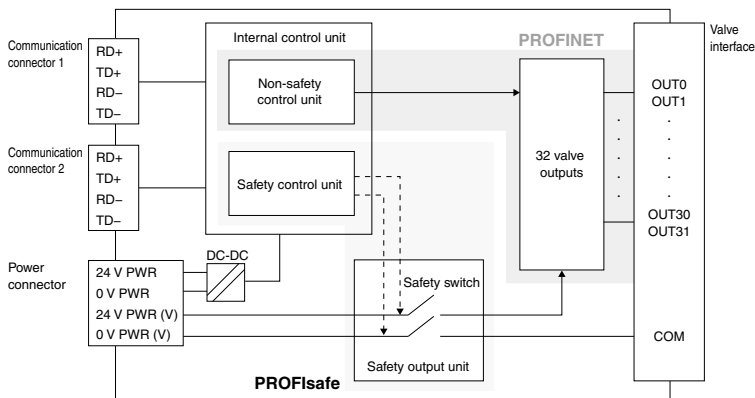

## ⚠ Safety Definition

The safe state of this product (EX260-FPS1) is a condition in which the safety output described above is turned OFF to shut off the supply of power to the valve manifold.  
This product does not cover valve manifolds that are being used in connection with this product or the safety function and safe state of electric/air equipment that includes a peripheral circuit.

## Reduced wiring, Space saving

### For built-in safety output (EX260-FPS1)

- A separate safety output unit is not required. (Space saving)
- There is no need for wiring between the safety output unit and the EX260-FPS1. (Reduced wiring)

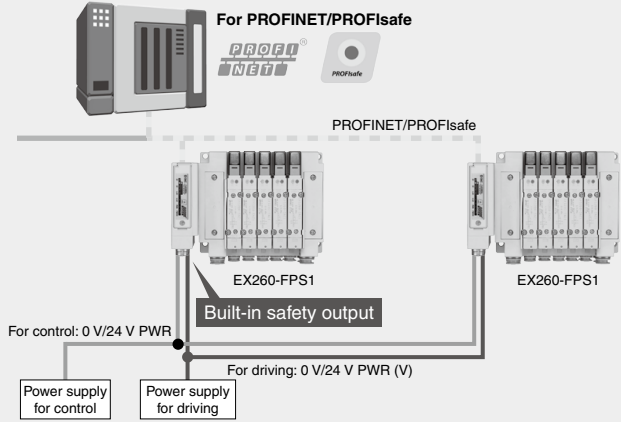

### When a separate safety output unit is installed (Conventional connection example)

- A separate safety output unit is required. (Increased installation space)
- Increased wiring is required for connection with another unit. (Increased wiring)

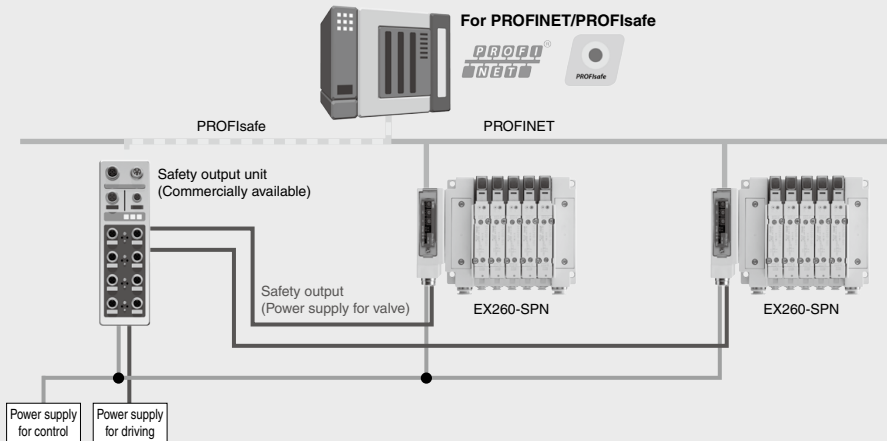

## **⚠ Safety of the machine or system**

The manufacturer of the machine/system and its user are responsible for the safety of the machine/system. Use of this product (EX260-FPS1) requires machine/system safety concepts which are in accordance with the corresponding directives and standards, safety function validation, and hazard and risk analysis. Target SILs (IEC 61508/62061 compliance) and performance levels/categories (ISO 13849 compliance) are determined based on the risk analysis. For more information, refer to the "Safety of the machine or system" section in the operation manual of the EX260-FPS1.

# CONTENTS

## Fieldbus System (Output device for driving 5-port solenoid valves) **EX260 Series**

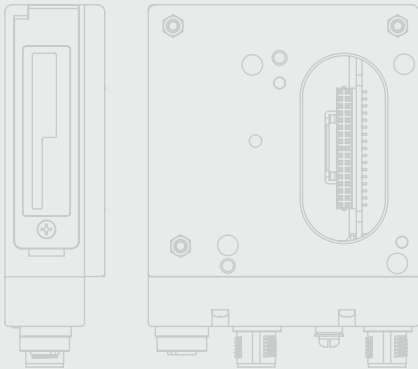
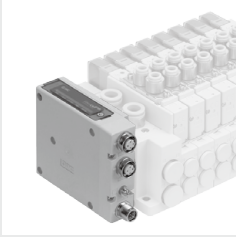

How to Order SI Units .....	p. 1320
Specifications .....	p. 1321
Dimensions .....	p. 1323
Parts Description .....	p. 1324
LED Indicator .....	p. 1325

### Accessories

① Communication Cable .....	p. 1326
② Field-wireable Communication Connector .....	p. 1332
③ Power Supply Cable (For SI unit) .....	p. 1333
④ Power Supply Cable (For SI unit/For power block) ..	p. 1334
⑤ Seal Cap (10 pcs.) .....	p. 1334
⑥ Output Block .....	p. 1335
⑦ Power Block .....	p. 1335
⑧ Connector for Output Block Wiring .....	p. 1336
⑨ End Plate .....	p. 1336
⑩ Bracket Plate/DIN Rail Mounting Bracket .....	p. 1336

### Made to Order

SI Unit	
EtherNet/IP™ Web server function compatible ...	p. 1337
Communication Cable .....	p. 1337
Power Supply Cable .....	p. 1338

Specific Product Precautions .....	p. 1339
------------------------------------	---------

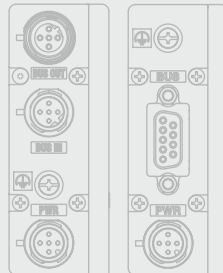



# Fieldbus System For Output

# EX260 Series



## Compact design

Compact design for space saving

## Number of outputs

32/16 digital output type available for each unit in the series  
(IO-Link and PROFIsafe are only compatible with the 32-point digital output type.)

## Output polarity

Negative common (PNP)/positive common (NPN) type available for each unit in the series  
(Only negative common (PNP) is available for Ethernet POWERLINK, IO-Link, and PROFIsafe.)

## Enclosure

IP67 (For units with a D-sub connector, and when connected with S0700 manifolds, it is IP40.)

## Internal terminating resistor

ON/OFF switching is possible with an internal terminating resistor for communication.  
(Only for units compatible with M12 PROFIBUS DP, CC-Link communication connectors)

## Applicable Manifold

SY3000/5000/7000

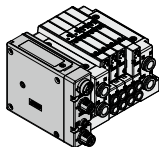

S0700

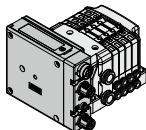

JSY1000/3000/5000

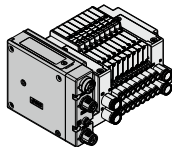

SV1000/2000/3000

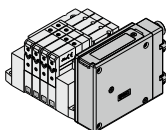

VQC1000/2000/4000/5000

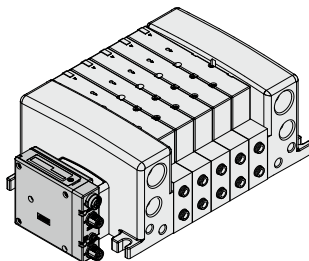

## Applicable Vacuum Unit

ZK2□A

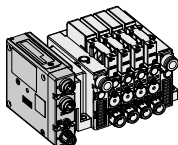

## How to Order SI Units

### EX260 - S **PR1**

#### Communication protocol

Symbol	Protocol	Number of outputs	Output polarity	Communication connector	Manifold symbol	Applicable manifold/Vacuum unit
<b>DN1</b>	DeviceNet®	32	Source/PNP (Negative common)	M12	QAN	SY3000/5000/7000 JSY1000/3000/5000 VQC1000/2000/4000/5000 S0700 SV1000/2000/3000 ZK2□A
<b>DN2</b>			Sink/NPN (Positive common)		QA	
<b>DN3</b>		16	Source/PNP (Negative common)		QBN	
<b>DN4</b>			Sink/NPN (Positive common)		QB	
<b>PR1</b>	PROFIBUS DP	32	Source/PNP (Negative common)	M12	NAN	
<b>PR2</b>			Sink/NPN (Positive common)		NA	
<b>PR3</b>		16	Source/PNP (Negative common)		NBN	
<b>PR4</b>			Sink/NPN (Positive common)		NB	
<b>PR5</b>		32	Source/PNP (Negative common)	D-sub*1	NCN	
<b>PR6</b>			Sink/NPN (Positive common)		NC	
<b>PR7</b>		16	Source/PNP (Negative common)		NDN	
<b>PR8</b>			Sink/NPN (Positive common)		ND	
<b>MJ1</b>	CC-Link	32	Source/PNP (Negative common)	M12	VAN	
<b>MJ2</b>			Sink/NPN (Positive common)		VA	
<b>MJ3</b>		16	Source/PNP (Negative common)		VBN	
<b>MJ4</b>			Sink/NPN (Positive common)		VB	
<b>EC1</b>	EtherCAT	32	Source/PNP (Negative common)	M12	DAN	
<b>EC2</b>			Sink/NPN (Positive common)		DA	
<b>EC3</b>		16	Source/PNP (Negative common)		DBN	
<b>EC4</b>			Sink/NPN (Positive common)		DB	
<b>PN1</b>	PROFINET	32	Source/PNP (Negative common)	M12	FAN	
<b>PN2</b>			Sink/NPN (Positive common)		FA	
<b>PN3</b>		16	Source/PNP (Negative common)		FBN	
<b>PN4</b>			Sink/NPN (Positive common)		FB	
<b>EN1</b>	EtherNet/IP™	32	Source/PNP (Negative common)	M12	EAN	
<b>EN2</b>			Sink/NPN (Positive common)		EA	
<b>EN3</b>		16	Source/PNP (Negative common)		EBN	
<b>EN4</b>			Sink/NPN (Positive common)		EB	
<b>PL1</b>	Ethernet POWERLINK	32	Source/PNP (Negative common)	M12	GAN	
<b>PL3</b>		16			GBN	
<b>IL1</b>	IO-Link	32	Source/PNP (Negative common)	M12	KAN	SY3000/5000/7000 JSY1000/3000/5000 VQC1000/2000/4000/5000 ZK2□A

\*1 Enclosure is IP40 when the communication connector is D-sub.



**Made to Order**

→ p. 1337

EtherNet/IP™ LAN cable connectable RJ45 communication connectors
EtherNet/IP™ Web server function compatible

\* For "How to Order Manifold Assembly," refer to the **Web Catalog** of each valve.

#### Safety communication compliant SI unit

### EX260 - F **PS1**

#### Communication protocol

Symbol	Protocol	Number of outputs	Output polarity	Communication connector	Manifold symbol	Applicable manifold
<b>PS1</b>	PROFIsafe	32	Source/PNP (Negative common)	M12	FPN	SY3000/5000/7000 JSY1000/3000/5000 VQC1000/2000/4000/5000

\* The use of validated products may be required for valve manifolds used in the safety-related parts of equipment which is compliant with safety standard ISO 13849. For validated products, please contact your SMC sales representative.

## Specifications

### All SI Units Common Specifications

Power supply for control	Power supply voltage	21.6 to 26.4 VDC*1
	Internal current consumption	100 mA or less*4
Power supply for output	Power supply voltage	22.8 to 26.4 VDC
	Enclosure	IP67*2
Environmental resistance	Operating temperature range	-10 to +50°C
	Operating humidity range	35 to 85% RH (No condensation)
	Withstand voltage	500 VAC for 1 minute between terminals and housing
	Insulation resistance	10 MΩ or more (500 VDC measured via megohmmeter) between terminals and housing
Standards	CE/UKCA marking, UL (CSA) compliant	
Weight	200 g	
	Mounting screw	
Accessories	2 pcs.	
	Seal cap (for M12 connector socket)	EX9-AWTS (1 pc.)*3

\*1 To serve as the power supply for communication, the power supply voltages are 11 to 25 VDC for the EX260-SDN□, 18 to 30 VDC for the EX260-SIL1, and 20.4 to 28.8 VDC for the EX260-FPS1.

\*2 IP40 applies to EX260-SPR5/6/7/8.

\*3 Not provided for EX260-SPR5/6/7/8

\*4 200 mA or less for the EX260-FPS1

Model	EX260-SPR1/3	EX260-SPR2/4	EX260-SPR5/7	EX260-SPR6/8	EX260-SDN1/3	EX260-SDN2/4	
Applicable system	Protocol					DeviceNet®	
	Version*1					DP-V0	
	Configuration file*3					GSD file	
I/O occupation area (Inputs/Outputs)	SPR1: 0/32 SPR3: 0/16	SPR2: 0/32 SPR4: 0/16	SPR5: 0/32 SPR7: 0/16	SPR6: 0/32 SPR8: 0/16	SDN1: 0/32 SDN3: 0/16	SDN2: 0/32 SDN4: 0/16	
Applicable function	—					QuickConnect™	
Communication speed	9.6 k/19.2 k/45.45 k/93.75 k/187.5 k/500 k/1.5 M/3 M/6 M/12 Mbps					125 k/250 k/500 kbps	
Communication connector specification	M12			D-sub*4		M12	
Terminating resistor switch	Built-in			None			
Output	Output type	Source/PNP (Negative common)	Sink/NPN (Positive common)	Source/PNP (Negative common)	Sink/NPN (Positive common)	Source/PNP (Negative common)	Sink/NPN (Positive common)
	Number of outputs	SPR1: 32 points SPR3: 16 points	SPR2: 32 points SPR4: 16 points	SPR5: 32 points SPR7: 16 points	SPR6: 32 points SPR8: 16 points	SDN1: 32 points SDN3: 16 points	SDN2: 32 points SDN4: 16 points
	Load	Solenoid valve with surge voltage suppressor 24 VDC, 1.5 W or less (SMC)					
	Supplied voltage	24 VDC					
	Supplied current	SPR1: Max. 2.0 A SPR3: Max. 1.0 A	SPR2: Max. 2.0 A SPR4: Max. 1.0 A	SPR5: Max. 2.0 A SPR7: Max. 1.0 A	SPR6: Max. 2.0 A SPR8: Max. 1.0 A	SDN1: Max. 2.0 A SDN3: Max. 1.0 A	SDN2: Max. 2.0 A SDN4: Max. 1.0 A

Model	EX260-SMJ1/3	EX260-SMJ2/4	EX260-SEC1/3	EX260-SEC2/4	EX260-SPN1/3	EX260-SPN2/4		
Applicable system	Protocol					PROFINET*2		
	Version*1					PROFINET Specification Version 2.2		
	Configuration file*3					GSD file		
I/O occupation area (Inputs/Outputs)	SMJ1: 32/32 SMJ3: 32/32 (1 station, remote I/O stations)	SMJ2: 32/32 SMJ4: 32/32 (1 station, remote I/O stations)	SEC1: 0/32 SEC3: 0/16	SEC2: 0/32 SEC4: 0/16	SPN1: 0/32 SPN3: 0/16	SPN2: 0/32 SPN4: 0/16		
Applicable function	—					FSU, MRP		
Communication speed	156 k/625 k/2.5 M/5 M/10 Mbps			100 Mbps*2				
Communication connector specification	M12							
Terminating resistor switch	Built-in			None (Not required)				
Output	Output type	Source/PNP (Negative common)	Sink/NPN (Positive common)	Source/PNP (Negative common)	Sink/NPN (Positive common)	Source/PNP (Negative common)	Sink/NPN (Positive common)	
	Number of outputs	SMJ1: 32 points SMJ3: 16 points	SMJ2: 32 points SMJ4: 16 points	SEC1: 32 points SEC3: 16 points	SEC2: 32 points SEC4: 16 points	SPN1: 32 points SPN3: 16 points	SPN2: 32 points SPN4: 16 points	
	Load	Solenoid valve with surge voltage suppressor 24 VDC, 1.5 W or less (SMC)					Solenoid valve with surge voltage suppressor 24 VDC, 1.0 W or less (SMC)	
	Supplied voltage	24 VDC						
	Supplied current	SMJ1: Max. 2.0 A SMJ3: Max. 1.0 A	SMJ2: Max. 2.0 A SMJ4: Max. 1.0 A	SEC1: Max. 2.0 A SEC3: Max. 1.0 A	SEC2: Max. 2.0 A SEC4: Max. 1.0 A	SPN1: Max. 2.0 A SPN3: Max. 1.0 A	SPN2: Max. 2.0 A SPN4: Max. 1.0 A	

\*1 Please note that the version is subject to change.

\*2 Use a CAT5 or higher communication cable for EtherCAT, PROFINET, Ethernet/IP™, and Ethernet POWERLINK.

\*3 The configuration file can be downloaded from the SMC website: <https://www.smcworld.com>

\*4 Enclosure is IP40 when the communication connector is D-sub.

# EX260 Series

## Specifications

Model		EX260-SEN1/3	EX260-SEN2/4	EX260-SPL1	EX260-SPL3	EX260-SIL1	EX260-FPS1	
Applicable system	Protocol	EtherNet/IP™*2		Ethernet POWERLINK		IO-Link	PROFINET/ PROFIsafe*2	
	Version*1	Volume 1 (Edition 3.17) Volume 2 (Edition 1.18)		EPG DS 301 Version 1.2.0		V1.1	PROFINET Specification Version 2.3 PROFIsafe Specification Version 2.4	
	Configuration file*3	EDS file		XDD file		IODD file	GSD file	
I/O occupation area (Inputs/Outputs)	SEN1: 16/32 SEN3: 16/16	SEN2: 16/32 SEN4: 16/16	16/32	16/16	0/32 16/32*4	0/32*5		
Applicable function	QuickConnect™, DLR		—		—	—	FSU, Shared Device, MRP	
Communication speed	10 M/100 Mbps*2		100 Mbps*2		COM3/COM2*4	100 Mbps*2		
Communication connector specification	M12							
Terminating resistor switch	None (Not required)							
Output	Output type	Source/PNP (Negative common)	Sink/NPN (Positive common)	Source/PNP (Negative common)				
	Number of outputs	SEN1: 32 points SEN3: 16 points	SEN2: 32 points SEN4: 16 points	32	16	32		
	Load	Solenoid valve with surge voltage suppressor 24 VDC, 1.5 W or less (SMC)					Solenoid valve with surge voltage suppressor 24 VDC, 0.95 W or less (SMC)	
	Supplied voltage	24 VDC						
Supplied current	SEN1: Max. 2.0 A SEN3: Max. 1.0 A	SEN2: Max. 2.0 A SEN4: Max. 1.0 A	Max. 2 A	Max. 1 A	Max. 2 A	Max. 1.3 A		

\*1 Please note that the version is subject to change.

\*2 Use a CAT5 or higher communication cable for PROFINET, PROFIsafe, EtherNet/IP™, and Ethernet POWERLINK.

\*3 The configuration file can be downloaded from the SMC website: <https://www.smcworld.com>

\*4 A selection can be made using the setting switch.

\*5 In addition, it occupies input 4 bite/output 5 bite for safety.

## Dimensions

### M12 communication connector type

- For PROFIBUS DP    For DeviceNet®  
For CC-Link    For EtherCAT    For PROFINET  
For EtherNet/IP™    For Ethernet POWERLINK

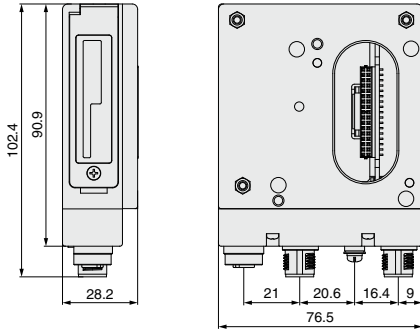

### D-sub communication connector type (EX260-SPR5/6/7/8)

- For PROFIBUS DP

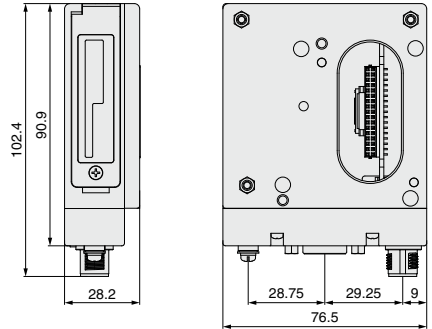

### M12 communication connector type

- For IO-Link

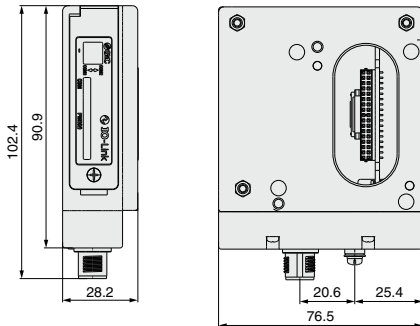

### M12 communication connector type

- For PROFI-safe

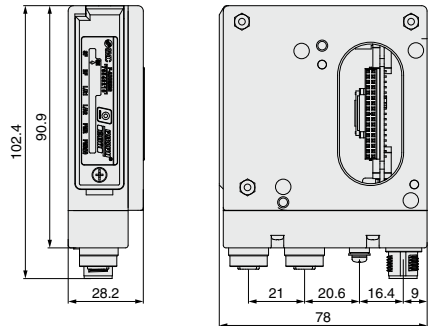

# EX260 Series

## Parts Description

For PROFIBUS DP    For DeviceNet®    For CC-Link  
 For PROFIsafe    For EtherCAT    For PROFINET  
 For EtherNet/IP™    For Ethernet POWERLINK

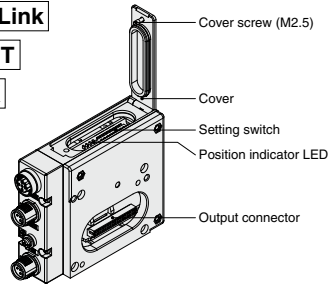

\* The setting switch varies depending on the model.  
 Refer to the operation manual for details.  
 It can be downloaded via the SMC website: <https://www.smcworld.com>

### <Connector> M12 communication connector type



Part no.	EX260-SPR1/-SPR2 -SPR3/-SPR4	EX260-SDN□	EX260-SMJ□	EX260-SEC□ EX260-SPN□ EX260-SEN□ EX260-SPL□ EX260-FPS1
Communication protocol	PROFIBUS DP	DeviceNet®	CC-Link	EtherCAT PROFINET EtherNet/IP™ EtherNet POWERLINK PROFIsafe
Communication connector (M12) BUS OUT	5 pins, socket, B code (SPEEDCON)	5 pins, socket, A code (SPEEDCON)	5 pins, socket, A code*1 (SPEEDCON)	4 pins, socket, D code (SPEEDCON)
Communication connector (M12) BUS IN	5 pins, plug, B code (SPEEDCON)	5 pins, plug, A code (SPEEDCON)	4 pins, plug, A code (SPEEDCON)	4 pins, socket, D code (SPEEDCON)
Ground terminal	M3			
Power connector (M12)	5 pins, plug, A code (SPEEDCON)	4 pins, plug, A code (SPEEDCON)	5 pins, plug, B code (SPEEDCON)	5 pins*2, 4 pins*3, plug, A code (SPEEDCON)

\*1 Recommended mating M12 4-pin plug part no.: PCA-1567717

\*2 For EtherCAT, PROFINET, and Ethernet POWERLINK  
 \*3 For EtherNet/IP™ and PROFIsafe

### <Connector> D-sub communication connector type

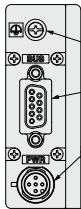

Part no.	EX260-SPR5/-SPR6/-SPR7/-SPR8
Communication protocol	PROFIBUS DP
Ground terminal	M3
Communication connector (D-sub) BUS IN/OUT	9 pins, socket
Power connector (M12)	5 pins, plug, A code

### For IO-Link

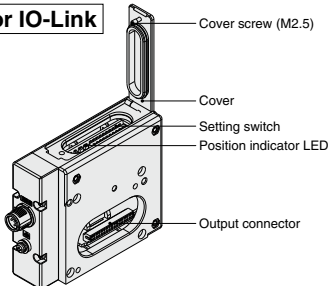

### <Connector>

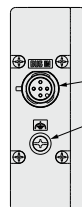

Part no.	EX260-SIL1
Communication protocol	IO-Link
Communication/Power connector (M12)	5 pins, plug,*1 A code (SPEEDCON)
Ground terminal	M3

\*1 The communication line, SI unit power supply line, and the solenoid valve power supply line are connected using the same cable.

\* The setting switch varies depending on the model.  
 Refer to the operation manual for details.  
 It can be downloaded via the SMC website: <https://www.smcworld.com>

**LED Indicator**

**For DeviceNet® EX260-SDN**

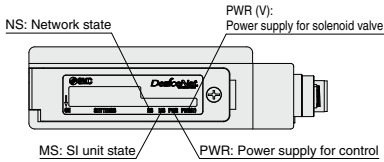

**For EtherCAT EX260-SEC**

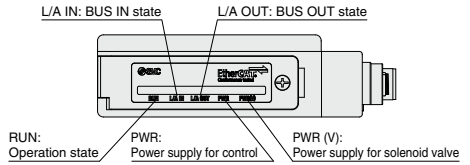

**For EtherNet/IP™ EX260-SEN**

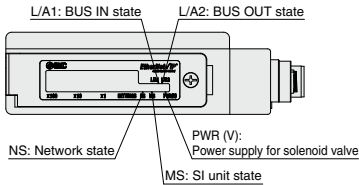

**For CC-Link EX260-SMJ**

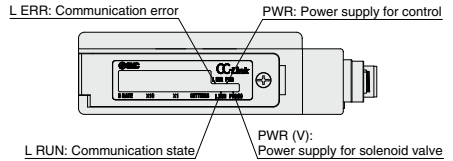

**For PROFINET EX260-SPN**

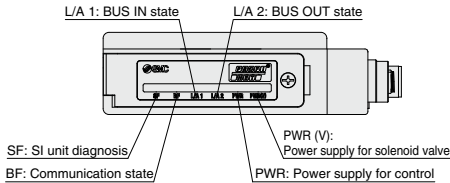

**For PROFIBUS DP EX260-SPR**

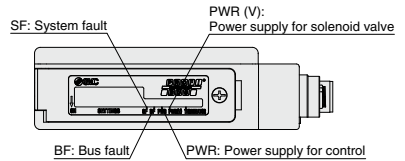

**For Ethernet POWERLINK EX260-SPL**

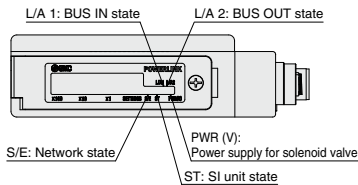

**For IO-Link EX260-SIL1**

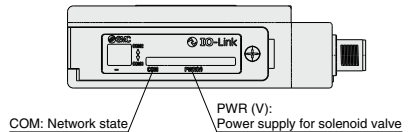

**For PROFIsafe EX260-FPS1**

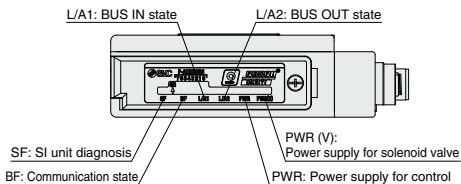

# EX260 Series Accessories

## ① Communication Cable

For CC-Link

**PCA-1567720**  
(Socket)



Socket connector pin arrangement  
A-coded (Normal key)

≠1 Number of holes: 5,  
Total number of pins: 4

**PCA-1567717**  
(Plug)



Plug connector pin arrangement  
A-coded (Normal key)

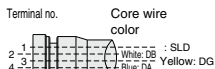
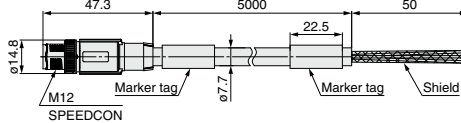
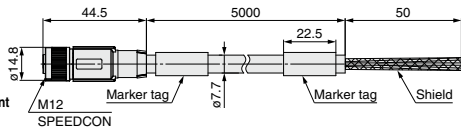

Connections

Item		Specifications
Cable O.D.		ø7.7 mm
Conductor nominal cross section	Data pair	0.5 mm <sup>2</sup> /AWG20
	Drain	0.34 mm <sup>2</sup> /AWG22
Wire O.D. (Including insulator)		2.55 mm
Min. bending radius (Fixed)		77 mm



Made to Order

Cable length	10000 mm	p. 1337
--------------	----------	---------

**EX9-AC [005] MJ-SSPS** (With connector on both sides (Socket/Plug))

● Cable length (L)

<b>005</b>	500 mm
<b>010</b>	1000 mm
<b>020</b>	2000 mm
<b>030</b>	3000 mm
<b>050</b>	5000 mm
<b>100</b>	10000 mm

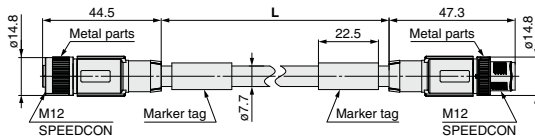

Socket connector pin arrangement  
A-coded (Normal key)

≠1 Number of holes: 5,  
Total number of pins: 4

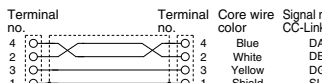

Connections



Plug connector pin arrangement  
A-coded (Normal key)

Item		Specifications
Cable O.D.		ø7.7 mm
Conductor nominal cross section	Data pair	0.5 mm <sup>2</sup> /AWG20
	Drain	0.34 mm <sup>2</sup> /AWG22
Wire O.D. (Including insulator)		2.55 mm
Min. bending radius (Fixed)		77 mm

**EX9-AC [005] MJ-SAPA** (With angled connector on both sides (Socket/Plug))

● Cable length (L)

<b>005</b>	500 mm
<b>010</b>	1000 mm
<b>020</b>	2000 mm
<b>030</b>	3000 mm
<b>050</b>	5000 mm
<b>100</b>	10000 mm

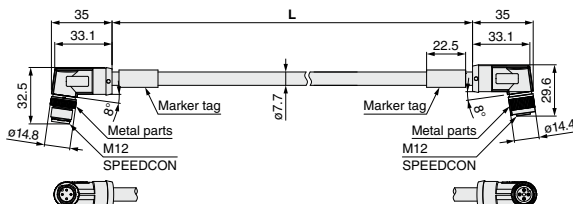

Plug connector pin arrangement  
A-coded (Normal key)

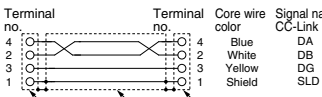

Connections



Socket connector pin arrangement  
A-coded (Normal key)

≠1 Number of holes: 5,  
Total number of pins: 4

Item		Specifications
Cable O.D.		ø7.7 mm
Conductor nominal cross section	Data pair	0.5 mm <sup>2</sup> /AWG20
	Drain	0.34 mm <sup>2</sup> /AWG22
Wire O.D. (Including insulator)		2.55 mm
Min. bending radius (Fixed)		77 mm



**1 Communication Cable**

**For DeviceNet®**

**PCA-1557633**  
(Socket)



Socket connector pin arrangement A-coded (Normal key)

**PCA-1557646**  
(Plug)



Plug connector pin arrangement A-coded (Normal key)

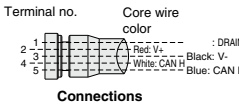
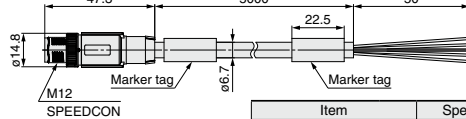
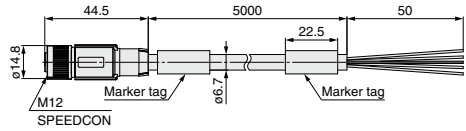

Item		Specifications
<b>Cable O.D.</b>		ø6.7 mm
<b>Conductor nominal cross section</b>	Power pair	0.34 mm <sup>2</sup> /AWG22
	Data pair	0.25 mm <sup>2</sup> /AWG24
<b>Wire O.D. (including insulator)</b>	Power pair	1.4 mm
	Data pair	2.05 mm
<b>Min. bending radius (Fixed)</b>		67 mm



Made to Order

Cable length	10000 mm	p. 1337
--------------	----------	---------

**EX9-AC [005] DN-SSPS (With connector on both sides (Socket/Plug))**

• Cable length (L)

<b>005</b>	500 mm
<b>010</b>	1000 mm
<b>020</b>	2000 mm
<b>030</b>	3000 mm
<b>050</b>	5000 mm
<b>100</b>	10000 mm

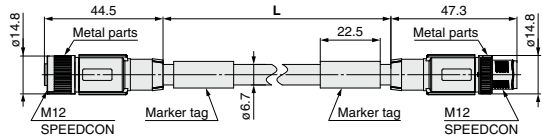

Socket connector pin arrangement A-coded (Normal key)

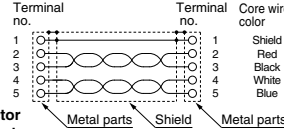

Connections



Plug connector pin arrangement A-coded (Normal key)

Item		Specifications
<b>Cable O.D.</b>		ø6.7 mm
<b>Conductor nominal cross section</b>	Power pair	0.34 mm <sup>2</sup> /AWG22
	Data pair	0.25 mm <sup>2</sup> /AWG24
<b>Wire O.D. (including insulator)</b>	Power pair	1.4 mm
	Data pair	2.05 mm
<b>Min. bending radius (Fixed)</b>		67 mm

**EX9-AC [005] DN-SAPA (With angled connector on both sides (Socket/Plug))**

• Cable length (L)

<b>005</b>	500 mm
<b>010</b>	1000 mm
<b>020</b>	2000 mm
<b>030</b>	3000 mm
<b>050</b>	5000 mm
<b>100</b>	10000 mm

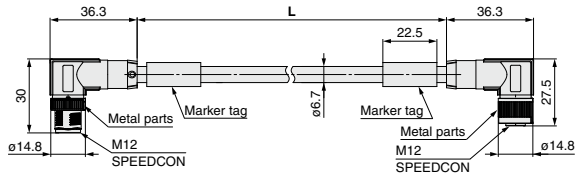

Plug connector pin arrangement A-coded (Normal key)

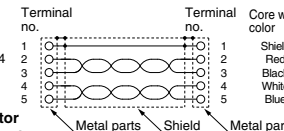

Connections

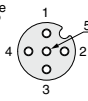

Socket connector pin arrangement A-coded (Normal key)

Item		Specifications
<b>Cable O.D.</b>		ø6.7 mm
<b>Conductor nominal cross section</b>	Power pair	0.34 mm <sup>2</sup> /AWG22
	Data pair	0.25 mm <sup>2</sup> /AWG24
<b>Wire O.D. (including insulator)</b>	Power pair	1.4 mm
	Data pair	2.05 mm
<b>Min. bending radius (Fixed)</b>		67 mm

# EX260 Series

## 1 Communication Cable

### For PROFIBUS DP

**PCA-1557688**  
(Socket)



Socket connector  
pin arrangement  
B-coded (Reverse key)

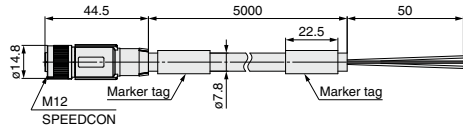

**PCA-1557691**  
(Plug)



Plug connector  
pin arrangement  
B-coded (Reverse key)

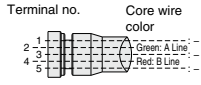
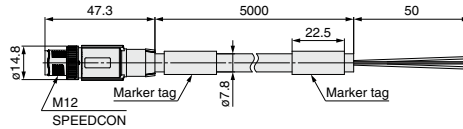

Connections

Item	Specifications
<b>Cable O.D.</b>	ø7.8 mm
<b>Conductor nominal cross section</b>	0.34 mm <sup>2</sup> /AWG22
<b>Wire O.D. (including insulator)</b>	2.55 mm
<b>Min. bending radius (Fixed)</b>	78 mm

### For EtherCAT

### For PROFINET

### For EtherNet/IP™

### For Ethernet POWERLINK

### For PROFIsafe

**EX9-AC 020 EN-PSRJ** (Plug/RJ-45 connector)

• Cable length (L)

<b>010</b>	1000 mm
<b>020</b>	2000 mm
<b>030</b>	3000 mm
<b>050</b>	5000 mm
<b>100</b>	10000 mm



Plug connector  
pin arrangement  
D-coded

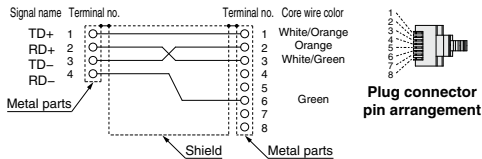
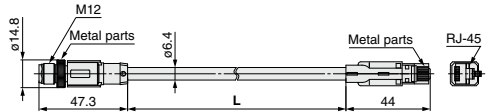

Connections (Straight cable)

Item	Specifications
<b>Cable O.D.</b>	ø6.4 mm
<b>Conductor nominal cross section</b>	0.14 mm <sup>2</sup> /AWG26
<b>Wire O.D. (including insulator)</b>	0.98 mm
<b>Min. bending radius (Fixed)</b>	26 mm

**PCA-1446566** (Plug)



Plug connector  
pin arrangement  
D-coded

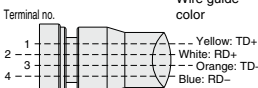
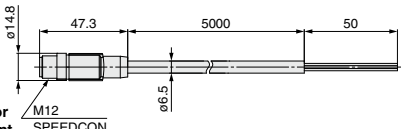

Connections

Item	Specifications
<b>Cable O.D.</b>	ø6.5 mm
<b>Conductor nominal cross section</b>	0.34 mm <sup>2</sup> /AWG22
<b>Wire O.D. (including insulator)</b>	1.55 mm
<b>Min. bending radius (Fixed)</b>	19.5 mm

**1 Communication Cable**

For EtherCAT

For PROFINET

For EtherNet/IP™

For Ethernet POWERLINK

For PROFIsafe

**EX9-AC 005 EN-PSPS (With connector on both sides (Plug/Plug))**

● Cable length (L)

005	500 mm
010	1000 mm
020	2000 mm
030	3000 mm
050	5000 mm
100	10000 mm

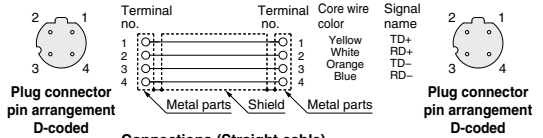
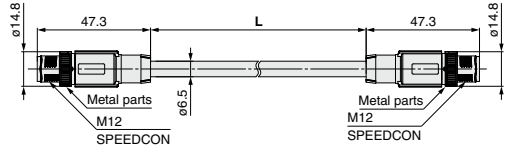

Item	Specifications
<b>Cable O.D.</b>	ø6.5 mm
<b>Conductor nominal cross section</b>	0.34 mm <sup>2</sup> /AWG22
<b>Wire O.D. (Including insulator)</b>	1.55 mm
<b>Min. bending radius (Fixed)</b>	19.5 mm

**EX9-AC 005 EN-PAPA (With angled connector on both sides (Plug/Plug))**

● Cable length (L)

005	500 mm
010	1000 mm
020	2000 mm
030	3000 mm
050	5000 mm
100	10000 mm

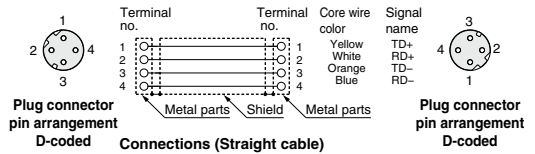
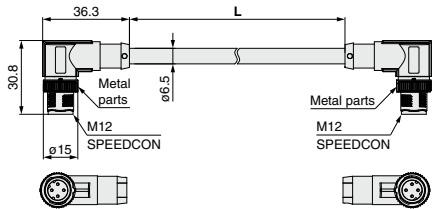

Item	Specifications
<b>Cable O.D.</b>	ø6.5 mm
<b>Conductor nominal cross section</b>	0.34 mm <sup>2</sup> /AWG22
<b>Wire O.D. (Including insulator)</b>	1.55 mm
<b>Min. bending radius (Fixed)</b>	19.5 mm

# EX260 Series

## ① Communication Cable

For IO-Link

Connection examples

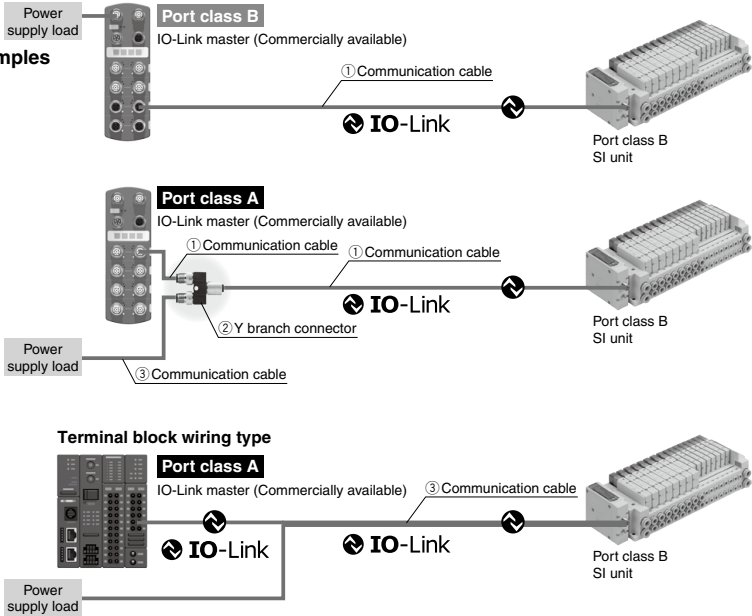

## ① Communication cable

EX9-AC [005]-SSPS (With connector on both sides (Socket/Plug))

• Cable length (L)

005	500 mm
010	1000 mm
020	2000 mm
030	3000 mm
050	5000 mm
100	10000 mm

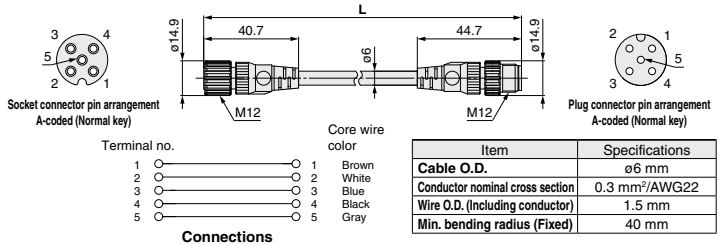

EX9-AC [005]-SAPA (With connector on both sides (Socket/Plug))

• Cable length (L)

005	500 mm
010	1000 mm
020	2000 mm
030	3000 mm
050	5000 mm
100	10000 mm

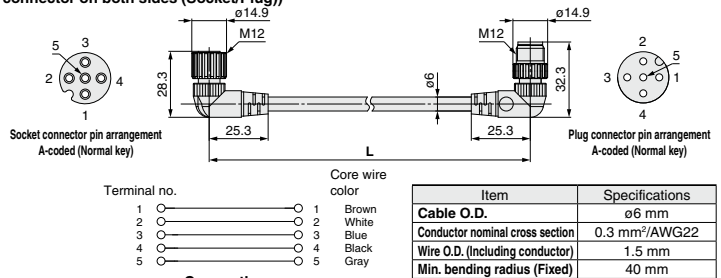

### ① Communication Cable

#### For IO-Link

#### ② Y branch connector

This connector is used to supply power to the valve manifold by branching the IO-Link communication cable in cases where a port class A IO-Link master is used.



#### EX9-ACY02-S

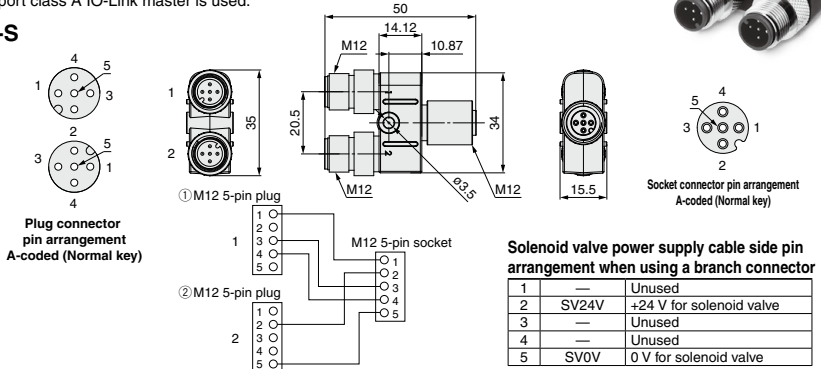

### ③ Communication cable

#### EX500-AP 050 - S

##### Cable length (L)

010	1000 mm
050	5000 mm

##### Connector specification

S	Straight
A	Angled

##### Straight connector type

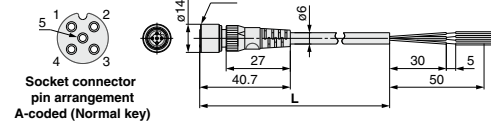

Item	Specifications
Cable O.D.	φ6 mm
Conductor nominal cross section	0.3 mm <sup>2</sup> /AWG22
Wire O.D. (Including insulator)	1.5 mm
Min. bending radius (Fixed)	40 mm

##### Angled connector type

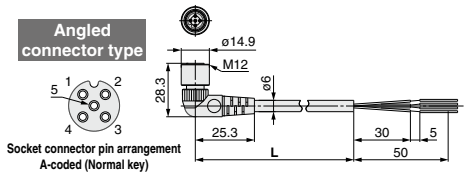

Item	Specifications
Cable O.D.	φ6 mm
Conductor nominal cross section	0.3 mm <sup>2</sup> /AWG22
Wire O.D. (Including insulator)	1.5 mm
Min. bending radius (Fixed)	40 mm



Made to Order

Cable length	10000 mm	p. 1338
--------------	----------	---------

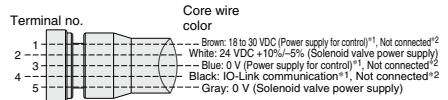

##### Connections (IO-Link)

- \*1 When used as an IO-Link communication cable
- \*2 When used as a solenoid valve power supply cable

#### PCA-1401804

##### Cable length (L)

1401804	1500 mm
1401805	3000 mm
1401806	5000 mm

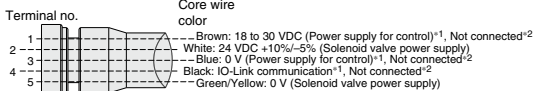
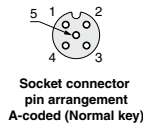

Item	Specifications
Cable O.D.	φ5 mm
Conductor nominal cross section	0.34 mm <sup>2</sup> /AWG22
Wire O.D. (Including insulator)	1.27 mm
Min. bending radius (Fixed)	21.7 mm

##### Connections (IO-Link)

- \*1 When used as an IO-Link communication cable
- \*2 When used as a solenoid valve power supply cable

# EX260 Series

## ② Field-wireable Communication Connector

### Plug

For CC-Link For DeviceNet®  
PCA-1075526 PCA-1075528

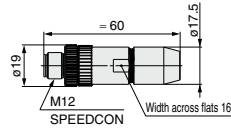

### Applicable Cable

Item	Specifications
Cable O.D.	4.0 to 8.0 mm
Wire gauge (Stranded wire cross section)	0.14 to 0.75 mm <sup>2</sup> /AWG26 to 18 (Solid cable/Flexible cable) 0.08 to 0.5 mm <sup>2</sup> /AWG28 to 20 (With ferrule)

For PROFIBUS DP  
PCA-1075530

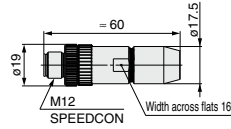

For EtherCAT For PROFINET For EtherNet/IP™ For Ethernet POWERLINK For PROFSafe  
PCA-1446553

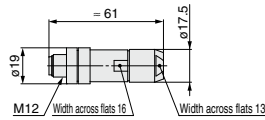

### Applicable Cable

Item	Specifications
Cable O.D.	4.0 to 8.0 mm
Wire gauge (Stranded wire cross section)	0.14 to 0.34 mm <sup>2</sup> /AWG26 to 22

\* The table above shows the specifications for the applicable cable. Adaptation for the connector may vary on account of the conductor construction of the electric wire.

### Socket

For CC-Link For DeviceNet®  
PCA-1075527 PCA-1075529

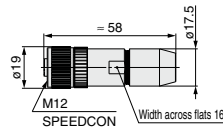

### Applicable Cable

Item	Specifications
Cable O.D.	4.0 to 8.0 mm
Wire gauge (Stranded wire cross section)	0.14 to 0.75 mm <sup>2</sup> /AWG26 to 18 (Solid cable/Flexible cable) 0.08 to 0.5 mm <sup>2</sup> /AWG28 to 20 (With ferrule)

For PROFIBUS DP  
PCA-1075531

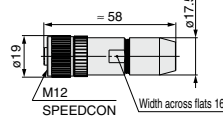

**③ Power Supply Cable (For SI unit)**

- For PROFIBUS DP   For DeviceNet®   For EtherCAT   For PROFINET   For EtherNet/IP™  
 For Ethernet POWERLINK   For PROFSafe

**EX500-AP 050 - S**

**Cable length (L)**

010	1000 mm
050	5000 mm

**Connector specification**

<b>S</b>	Straight
<b>A</b>	Angled

**Straight connector type**

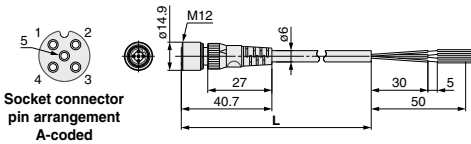

Item	Specifications
<b>Cable O.D.</b>	ø6 mm
<b>Conductor nominal cross section</b>	0.3 mm <sup>2</sup> /AWG22
<b>Wire O.D. (Including insulator)</b>	1.5 mm
<b>Min. bending radius (Fixed)</b>	40 mm

**Angled connector type**

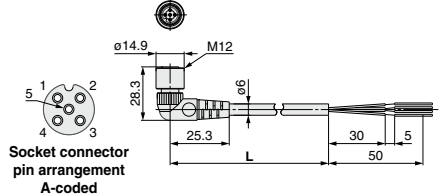

Item	Specifications
<b>Cable O.D.</b>	ø6 mm
<b>Conductor nominal cross section</b>	0.3 mm <sup>2</sup> /AWG22
<b>Wire O.D. (Including insulator)</b>	1.5 mm
<b>Min. bending radius (Fixed)</b>	40 mm

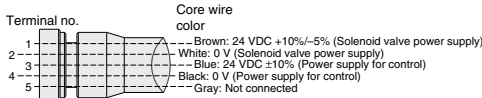

**Connections (PROFIBUS DP, EtherCAT, PROFINET, Ethernet POWERLINK, PROFSafe)**

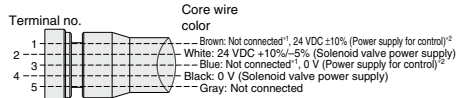

**Connections (DeviceNet®, EtherNet/IP™)**      <sup>#1</sup> For DeviceNet®  
<sup>#2</sup> For EtherNet/IP™



**Made to Order**

Cable length	10000 mm	p. 1338
--------------	----------	---------

**PCA-1401804**

**Cable length (L)**

1401804	1500 mm
1401805	3000 mm
1401806	5000 mm

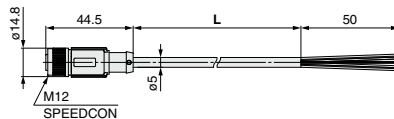
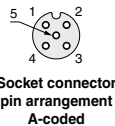

Item	Specifications
<b>Cable O.D.</b>	ø5 mm
<b>Conductor nominal cross section</b>	0.34 mm <sup>2</sup> /AWG22
<b>Wire O.D. (Including insulator)</b>	1.27 mm
<b>Min. bending radius (Fixed)</b>	21.7 mm

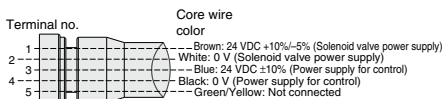

**Connections (PROFIBUS DP, EtherCAT, PROFINET, Ethernet POWERLINK, PROFSafe)**

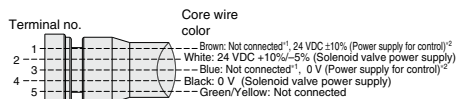

**Connections (DeviceNet®, EtherNet/IP™)**      <sup>#1</sup> For DeviceNet®  
<sup>#2</sup> For EtherNet/IP™

# EX260 Series

## ④ Power Supply Cable (For SI unit/For power block)

For CC-Link

For power block

Straight connector type

EX9-AC 050 -1

● Cable length (L)

010	1000 mm
030	3000 mm
050	5000 mm



Socket connector pin arrangement B-coded

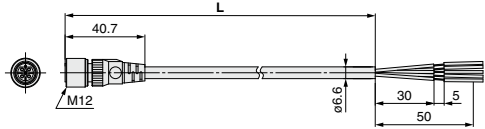

Item	Specifications
Cable O.D.	ø6.6 mm
Conductor nominal cross section	0.3 mm <sup>2</sup> /AWG22
Wire O.D. (Including insulator)	1.65 mm
Min. bending radius (Fixed)	40 mm



Made to Order

Cable length	10000 mm	p. 1338
--------------	----------	---------

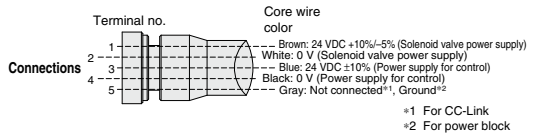

PCA- 1401807

● Cable length (L)

1401807	1500 mm
1401808	3000 mm
1401809	5000 mm



Socket connector pin arrangement B-coded

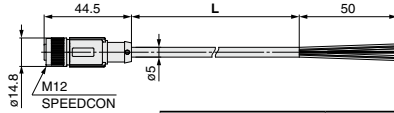

Item	Specifications
Cable O.D.	ø5 mm
Conductor nominal cross section	0.34 mm <sup>2</sup> /AWG22
Wire O.D. (Including insulator)	1.27 mm
Min. bending radius (Fixed)	21.7 mm

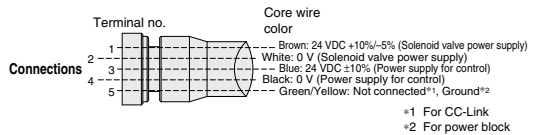

## ⑤ Seal Cap (10 pcs.)

Use this on ports that are not being used for communication connector (M12 connector socket).

Use of this seal cap maintains the integrity of the IP67 enclosure.

\* Tighten the seal cap with the prescribed tightening torque. (For M12: 0.1 N·m)

EX9-AW TS

● Connector specification

TS	For M12 connector socket (10 pcs.)
----	------------------------------------

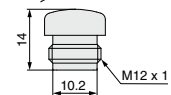
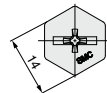

For M12 connector socket



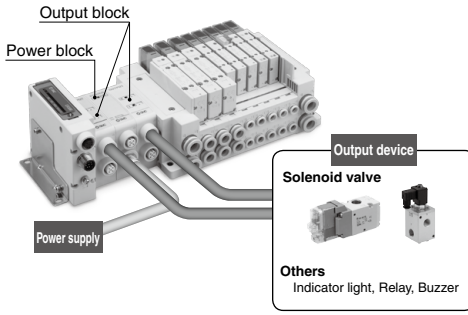

- Output devices other than valve manifold can be operated.
- By using the power block and output block for high watt load, operation up to 0.5 A/point can be performed.
- It is possible to mount the output block and power block additionally between the SI unit and the solenoid valve (The surplus I/O points are used).
- 2 point outputs per output block (M12 connector)

The output block and power block cannot be used with the PROFiSafe compatible SI unit EX260-FPS1.

You are requested to connect it to an SI unit and a valve manifold. For detailed specifications, refer to the operation manual that can be downloaded from SMC website: <https://www.smcworld.com>

## 6 Output Block

EX9-OE T 1

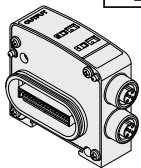

### ● Output specification

1	Source/PNP (Negative common)
2	Sink/NPN (Positive common)

### ● Power supply type

T	Internal power supply method (for low-wattage load)
P	Integrated power supply method (for high-wattage load)*1

\*1 Required to connect with a power block

### Dimensions/Parts Description

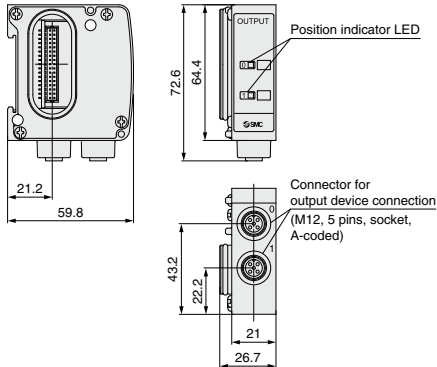

### Specifications

Model	EX9-OET1	EX9-OET2	EX9-OEP1	EX9-OEP2
Internal current consumption	40 mA or less			
Output	Output type	Source/PNP (Negative common)	Sink/NPN (Positive common)	Source/PNP (Negative common) / Sink/NPN (Positive common)
	Number of outputs	2 outputs		
	Power supply method	Internal power supply method	Integrated power supply method (Power block: supplied from EX9-PE1)	
	Output device supply voltage	24 VDC		
	Output device supply current	Max. 42 mA/point (1.0 W/point)   Max. 0.5 A/point (12 W/point)		
Environmental resistance	Enclosure	IP67		
	Operating temperature range	-10 to 50°C		
	Operating humidity range	35 to 85% RH (No condensation)		
Standards	CE/UKCA marking, UL (CSA)			
Weight	120 g			

## 7 Power Block

EX9-PE1

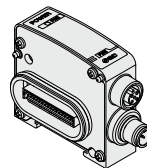

### Dimensions/Parts Description

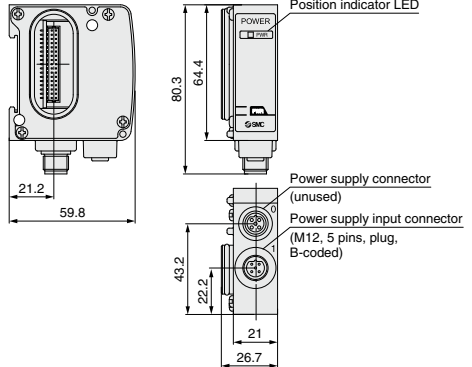

### Specifications

Model	EX9-PE1	
Connection block	Output block for high wattage load	
Connection block stations	Output block: Max. 8 stations	
Power supply for output and internal control	Power supply voltage: 22.8 to 26.4 VDC Internal current consumption: 20 mA or less	
Supply current	Max. 3.1 A*1	
Environmental resistance	Enclosure	IP67
	Operating temperature range	-10 to 50°C
Standards	Operating humidity range	35 to 85% RH (No condensation)
	CE/UKCA marking, UL (CSA)	
Weight	120 g	
Enclosed parts	Seal cap (for M12 connector) 1 pc.	

\*1 When using with 3.0 to 3.1 A, the ambient temperature should not exceed 40°C, and do not bundle the cable.

Refer to page 1334 for the power supply cable for power block.

# EX260 Series

## 8 Connector for Output Block Wiring

Field-wireable connector for connecting an output device to an output block

### PCA-1557743

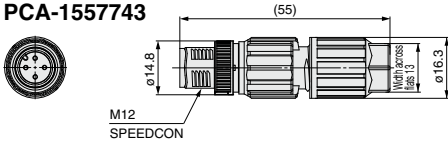

#### Applicable Cable

Item	Specifications
Cable O.D.	3.5 to 6.0 mm
Wire gauge (Stranded wire cross section)	0.14 to 0.34 mm <sup>2</sup> /AWG26 to 22
Core wire diameter (Including insulating material)	0.7 to 1.3 mm

#### A-coded



#### Plug pin arrangement

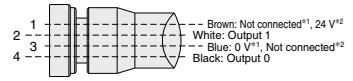

#### Connections

- \*1 When used for EX9-OE□1
- \*2 When used for EX9-OE□2

### PCA-1557756

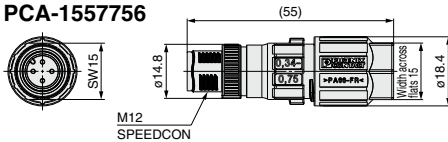

#### Applicable Cable

Item	Specifications
Cable O.D.	4.0 to 8.0 mm
Wire gauge (Stranded wire cross section)	0.34 to 0.75 mm <sup>2</sup> /AWG22 to 18
Core wire diameter (Including insulating material)	1.3 to 2.5 mm

#### A-coded



#### Plug pin arrangement

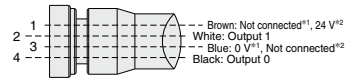

#### Connections

- \*1 When used for EX9-OE□1
- \*2 When used for EX9-OE□2

Refer to page 1334 for the power supply cable for power block.

## 9 End Plate

Use when an output block is being used and a valve manifold is not connected.

### EX9-EA03

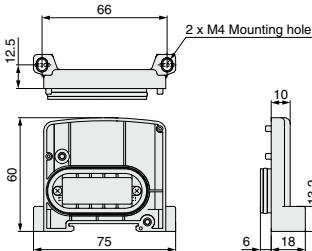

<Example of use>

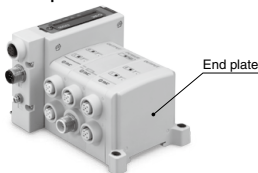

## 10 Bracket Plate/DIN Rail Mounting Bracket

A reinforcing brace used to mount an output block or power block onto an SI unit. To prevent connection failure between products due to deflection, use this bracket plate whenever an output block or power block is mounted.

### EX9-BP1

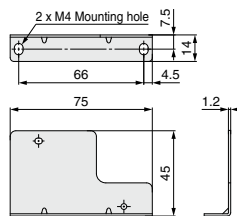

#### Accessory

Description	Qty.
Hexagon socket head cap screw (M3 x 35)	2

<Example of use>

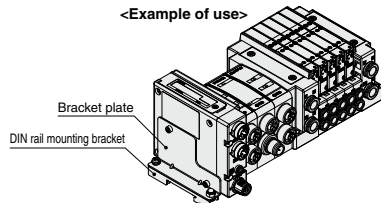

### EX9-BD1

(For VQC, S0700, SV)

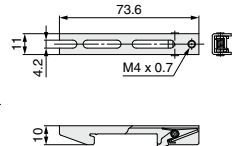

#### Accessory

Description	Qty.
Domed cap nut (M4)	1
Round head combination screw (M4 x 8)	1
Round head combination screw (M4 x 10)	1

# EX260 Series Made to Order

Please contact SMC for detailed specifications and lead times.



## SI Unit

Prepare the SI unit and valve manifold (without SI unit) separately, and combine them before use.

### ① EtherNet/IP™ LAN cable connectable RJ45 communication connectors

#### EX260-S-EN2-X205

Communication protocol  
EN EtherNet/IP™

Connector specification  
X205 Communication connector: RJ45  
Power connector: Spring type connector

Output specification  
2 32 outputs, NPN (Positive common)/Sink

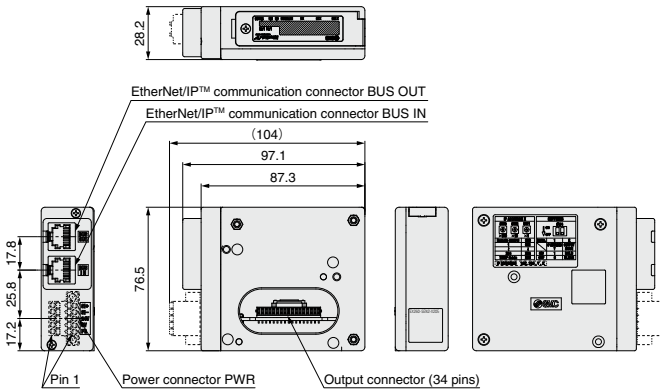

### ⚠ Caution

The dimensions when combined with the valve manifold are the same as the dimensions of the valve manifold with a standard EX260 series unit mounted.

### ② EtherNet/IP™ Web server function compatible

#### EX260-SEN1-X194

- Web server compatible: Can conduct a solenoid valve operation test (ON/OFF), check communication state, set QuickConnect™, etc.
- Applicable to the power supply taken from Rockwell Automation's safe output module with pulse test function
- Compliant with QuickConnect™ class A specifications
- The gateway address is set to 192.168.□.001 when the IP address is set by the rotary switch.
- Dimensions are the same as those of the standard type.

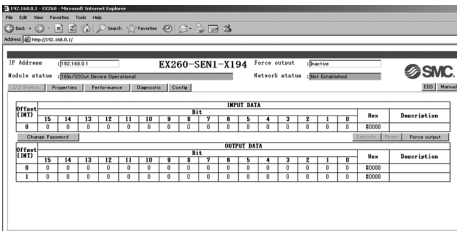

Web server screen (Example)

# EX260 Series

## Communication Cable

With connector on one side (Socket)  
Cable length: 10000 mm

For CC-Link

For DeviceNet®

EX9-AC100 MJ-X12

Applicable protocol

MJ	CC-Link
DN	DeviceNet®

For CC-Link

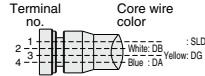
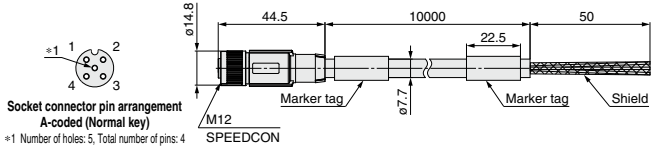

Connections

Item		Specifications
Cable O.D.		ø7.7 mm
Conductor nominal cross section	Data pair	0.5 mm <sup>2</sup> /AWG20
	Drain	0.34 mm <sup>2</sup> /AWG22
Wire O.D. (Including insulator)		2.55 mm
Min. bending radius (Fixed)		77 mm

For DeviceNet®

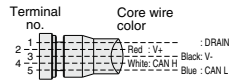
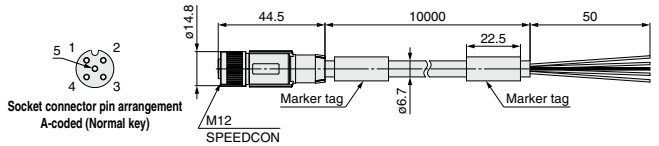

Connections

Item		Specifications
Cable O.D.		ø6.7 mm
Conductor nominal cross section	Power pair	0.34 mm <sup>2</sup> /AWG22
	Data pair	0.25 mm <sup>2</sup> /AWG24
Wire O.D. (Including insulator)	Power pair	1.4 mm
	Data pair	2.05 mm
Min. bending radius (Fixed)		67 mm

**Power Supply Cable**

① **With connector on one side (Socket)**

Cable length: 10000 mm

**For CC-Link** **For power block**

**EX9-AC100-1-X16**

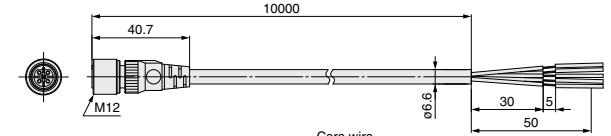

**Socket connector pin arrangement B-coded (Reverse key)**

Terminal no.	Core wire color
1	Brown: 24 VDC +10%/-5% (Solenoid valve power supply)
2	White: 0 V (Solenoid valve power supply)
3	Blue: 24 VDC ±10% (Power supply for control)
4	Black: 0 V (Power supply for control)
5	Gray: Not connected*1, Ground*2

\*1 For CC-Link  
\*2 For power block

Item	Specifications
<b>Cable O.D.</b>	ø6.6 mm
<b>Conductor nominal cross section</b>	0.3 mm <sup>2</sup> /AWG22
<b>Wire O.D. (Including insulator)</b>	1.65 mm
<b>Min. bending radius (Fixed)</b>	40 mm

② **With connector on one side (Socket)**

Cable length: 10000 mm

**For PROFIBUS DP** **For DeviceNet®** **For EtherCAT** **For PROFINET** **For EtherNet/IP™**

**For Ethernet POWERLINK** **For IO-Link** **For PROFIsafe**

**EX500-AP100-S-X1**

● **Connector specification**

<b>S</b>	Straight
<b>A</b>	Angled

**Straight connector type**

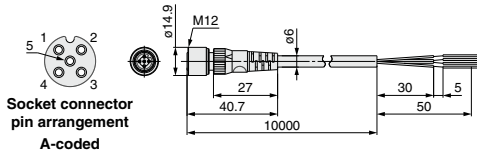

**Socket connector pin arrangement A-coded**

Item	Specifications
<b>Cable O.D.</b>	ø6 mm
<b>Conductor nominal cross section</b>	0.3 mm <sup>2</sup> /AWG22
<b>Wire O.D. (Including insulator)</b>	1.5 mm
<b>Min. bending radius (Fixed)</b>	40 mm

Terminal no.	Core wire color
1	Brown: 24 VDC +10%/-5% (Solenoid valve power supply)
2	White: 0 V (Solenoid valve power supply)
3	Blue: 24 VDC ±10% (Power supply for control)
4	Black: 0 V (Power supply for control)
5	Gray: Not connected

**Connections (PROFIBUS DP, EtherCAT, PROFINET, Ethernet POWERLINK, PROFIsafe)**

**Angled connector type**

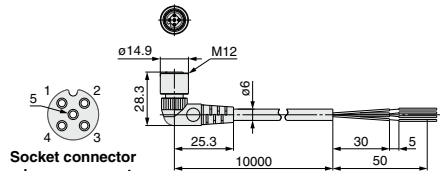

**Socket connector pin arrangement A-coded**

Item	Specifications
<b>Cable O.D.</b>	ø6 mm
<b>Conductor nominal cross section</b>	0.3 mm <sup>2</sup> /AWG22
<b>Wire O.D. (Including insulator)</b>	1.5 mm
<b>Min. bending radius (Fixed)</b>	40 mm

Terminal no.	Core wire color
1	Brown: Not connected*1, 24 VDC ±10% (Power supply for control)*2
2	White: 24 VDC +10%/-5% (Solenoid valve power supply)
3	Blue: Not connected*1, 0 V (Power supply for control)*2
4	Black: 0 V (Solenoid valve power supply)
5	Gray: Not connected

**Connections (DeviceNet®, EtherNet/IP™)**

\*1 For DeviceNet®  
\*2 For EtherNet/IP™

Terminal no.	Core wire color
1	Brown: 18 to 30 VDC (Power supply for control)*1, Not connected*2
2	White: 24 VDC +10%/-5% (Solenoid valve power supply)
3	Blue: 0 V (Power supply for control)*1, Not connected*2
4	Black: IO-Link communication*1, Not connected*2
5	Gray: 0 V (Solenoid valve power supply)

**Connections (IO-Link)**

\*1 When used as an IO-Link communication cable  
\*2 When used as a solenoid valve power supply cable



## EX260 Series

# Specific Product Precautions

Be sure to read this before handling the products. Refer to page 7 for safety instructions and pages 15 to 17 for fieldbus system precautions.

### Wiring

#### Caution

1. **Select connectors that are  $\phi 16$  or less if mounting valve manifolds directly using field-wireable connectors for SI unit power supply wiring.**

Using large diameter connectors causes interference with the mounting surface.

The following cables with connectors are recommended.

■ **For EX260-SPR□/SDN□/SEC□/SPN□/SEN□/SP□/**  
**-FPS1**

<Cable with connector>

- EX500-AP□□□-□
- PCA-1401804/-1401805/-1401806

■ **For EX260-SMJ□**

<Cable with connector>

- EX9-AC□□□-1
- PCA-1401807/-1401808/-1401809

### Operating Environment

#### Caution

1. **Select the proper type of enclosure according to the operating environment.**

IP67 is achieved when the following conditions are met.

- 1) Provide appropriate wiring between all units using electrical wiring cables, communication connectors and cables with M12 connectors.
- 2) Appropriately mount each unit and valve manifold.
- 3) Be sure to mount a seal cap on any unused connectors.

If using in an environment that is exposed to water splashes, please take measures such as using a cover.

When the enclosure is IP40, do not use in an operating environment or atmosphere where it may come in contact with corrosive gas, chemical agents, seawater, water, or water vapor.

When connected to the EX260-SPR5/6/7/8, manifold enclosure is IP40.

### Adjustment / Operation

#### Caution

1. **For details on programming and address setting, refer to the manual from the PLC manufacturer.**

The programming content related to the protocol is designed by the manufacturer of the PLC used.

2. **For the EX260-SPN□, the side of the SI unit may become hot.**

It may cause burns.

#### ■ Trademark

DeviceNet® is a registered trademark of ODVA, Inc.

EtherNet/IP® is a registered trademark of ODVA, Inc.

EtherCAT® is registered trademark and patented technology, licensed by Beckhoff Automation GmbH, Germany.

Modbus® is a registered trademark of Schneider Electric, licensed to the Modbus Organization, Inc.

QuickConnect™ is a trademark of ODVA.