

Fieldbus System (For Output)

EX120/121/122 Series



Compatible Protocols

DeviceNet[®] CC-Link CompoBus/S
CompoNet

Made to Order S-Link V

- ★ Small unit compatible with a maximum of 16 outputs
- ★ Compatible with a variety of communication networks

Manifold Solenoid Valves

EX120 Series

SV1000/2000/3000/4000

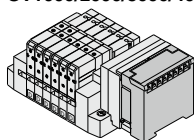

VQ1000/2000

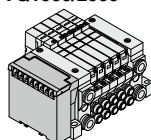

SY3000/5000/7000

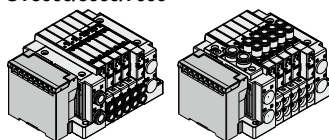

EX121 Series

SY3000/5000

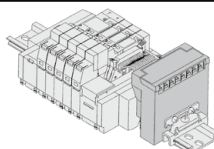

EX122 Series

SY3000/5000

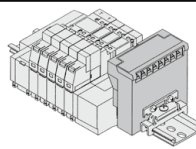

CONTENTS

Fieldbus System (For Output) EX120/121/122 Series



How to Order SI Unit	p. 1288
Specifications	p. 1289
Dimensions/Parts Description	p. 1290
LED Indicator	p. 1293

Accessories

① Communication Connector	p. 1294
② Power Supply Connector	p. 1294

Made to Order

① DeviceNet [®] PNP (Negative common) output, Occupied points: 16 inputs/16 outputs	p. 1294
② DeviceNet [®] PNP (Negative common) output, Occupied points: 0 inputs/16 outputs	p. 1294
③ S-LINK V compatible NPN (Positive common) 16 outputs	p. 1294

Specific Product Precautions	p. 1294
------------------------------------	---------

Fieldbus System For Output

EX120/121/122 Series

How to Order SI Unit

EX12 **0** - S **DN1** -

Valve interface

0	Plug-in
1	Flat ribbon cable DIN rail mounting
2	Plug-in DIN rail mounting

Made to Order (Refer to page 1294.)

Protocol	Output polarity	Occupied points
DeviceNet®	PNP (Negative common)	16 inputs/ 16 outputs
DeviceNet®	PNP (Negative common)	0 inputs/ 16 outputs
S-LINK V	NPN (Positive common)	0 inputs/ 16 outputs

Protocol

DN1	DeviceNet®*1
DN1-X26 *2	DeviceNet®*1
MJ1	CC-Link
CS1	OMRON Corp.: CompoBus/S (16 outputs)
CS2	OMRON Corp.: CompoBus/S (8 outputs)
CM1	CompoNet® NPN (Positive common)
CM3	CompoNet® PNP (Negative common)

*1 DN1's occupied points are 16 inputs and 16 outputs, while DN1-X26 has 0 inputs and 16 outputs.

*2 A manifold part number is not specified for this model.
Please contact SMC for the manifold integrated type.

Specifications

Common Specifications

Communication	Terminating resistor	Not provided
Internal current consumption (Unit)		100 mA or less
Environment	Enclosure	IP20
	Operating temperature range	0 to 55°C (Valve 8 points ON) 0 to 50°C (Valve 16 points ON)
	Operating humidity range	35 to 85%RH (No condensation)
	Withstand voltage	1500 VAC for 1 minute between whole external terminal and enclosure
	Insulation resistance	2 MΩ or more (500 VDC) between whole external terminal and enclosure

Model		EX12□-SDN1	EX12□-SDN1-X26	EX12□-SMJ1	EX12□-SCS1 EX12□-SCS2
Communication	Protocol	DeviceNet®		CC-Link	OMRON Corp.: CompoBus/S
	Version*1	Release 2.0		Ver. 1.10	—
	Communication speed	125 k/250 k/500 kbps		156 k/625 kbps 2.5 M/5 M/10 Mbps	750 kbps
	Configuration file*2	EDS file		CSP+ file	—
	I/O occupation area (Inputs/Outputs)	16/16	0/16	32/32 (1 station, remote I/O stations)	SCS1: 0/16 SCS2: 0/8
Power supply voltage	For control	11 to 25 VDC		15 to 30 VDC	14 to 26.4 VDC
	For valve	24 VDC +10%/−5%			
Output	Output type	Sink/NPN (Positive common)			
	Number of outputs	16 points			SCS1: 16 points SCS2: 8 points
	Load	Solenoid valve with surge voltage suppressor 24 VDC, 2.1 W or less (SMC)			
	Fail safe	CLEAR	HOLD/CLEAR (Switch setting)	CLEAR	HOLD/CLEAR (Switch setting)
Standards	CE/UKCA marking				
Weight	EX120: 110 g or less, EX121: 140 g or less, EX122: 130 g or less				
Accessory	Communication connector 1 pc., Power supply connector 1 pc.				—

*1 Please note that the version is subject to change.

*2 The setting file can be downloaded from the SMC website, <https://www.smcworld.com>

Model		EX12□-SCM1	EX12□-SCM3
Communication	Protocol	CompoNet®	
	Communication speed	93.75 kbps/1.5 M/3 M/4 Mbps	
	Configuration file	EDS file*1	
	I/O occupation area (Inputs/Outputs)	0/16	
Power supply voltage	For control	14 to 26.4 VDC	
	For valve	24 VDC +10%/−5%	
Output	Output type	Sink/NPN (Positive common)	Source/PNP (Negative common)
	Number of outputs	16 points	
	Load	Solenoid valve with surge voltage suppressor 24 VDC, 2.1 W or less (SMC)	
	Fail safe	HOLD/CLEAR (Setting via network)	
Standards	CE/UKCA marking		
Weight	EX120: 100 g or less		
	EX121: 120 g or less		
	EX122: 110 g or less (including accessory)		
Accessory	Power supply connector (EX9-CP2) 1 pc.*2		

*1 The setting file can be downloaded from the SMC website, <https://www.smcworld.com>

*2 Communication connector (for the opposite side) is not provided.

EX120/121/122 Series

Dimensions/Parts Description

EX120

EX120-SDN1(-X26)

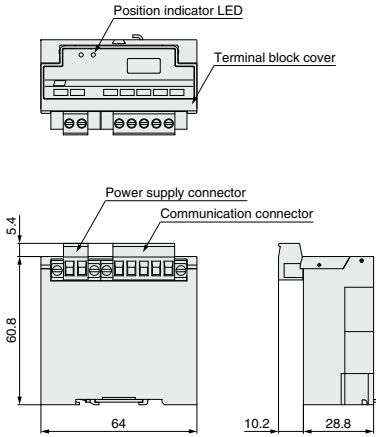

EX120-SMJ1, SCS

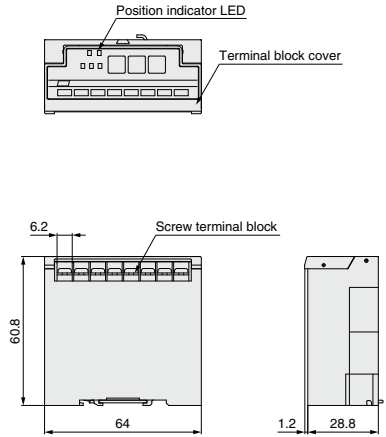

EX120-SCM

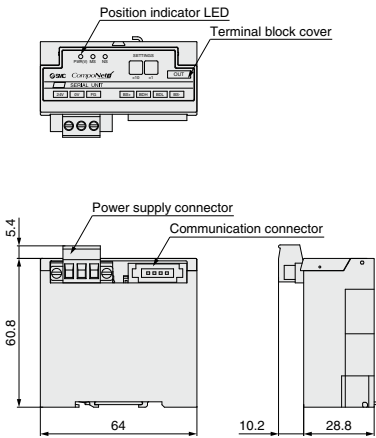

Dimensions/Parts Description

EX121

EX121-SDN1(-X26)

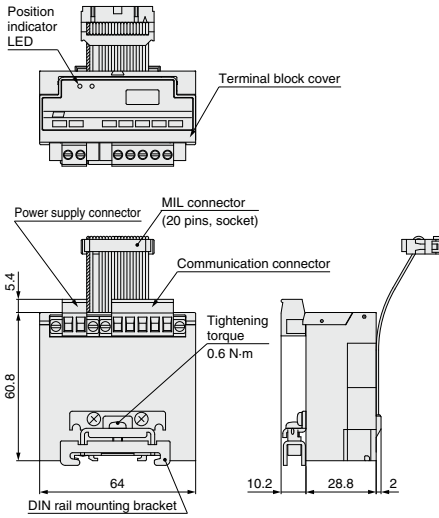

EX121-SMJ1, SCS□

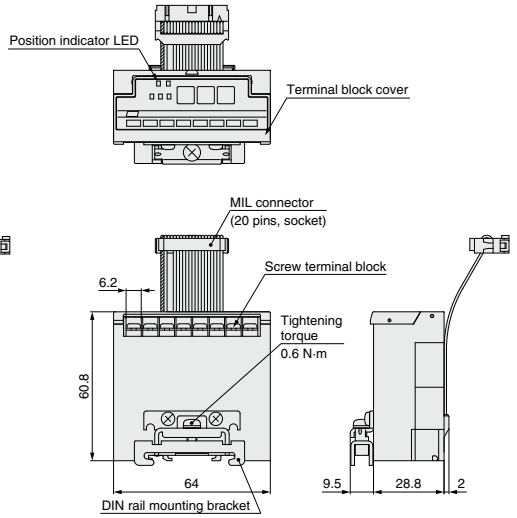

EX121-SCM□

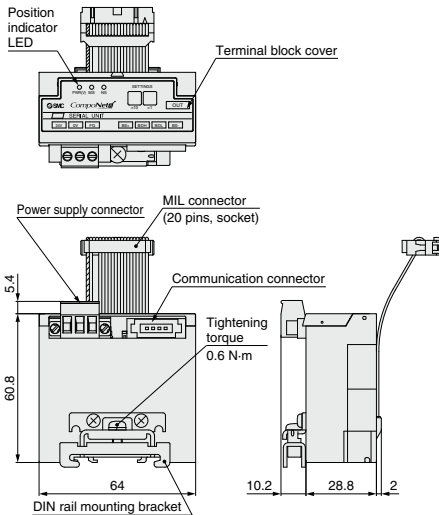

EX120/121/122 Series

Dimensions/Parts Description

EX122

EX122-SDN1(-X26)

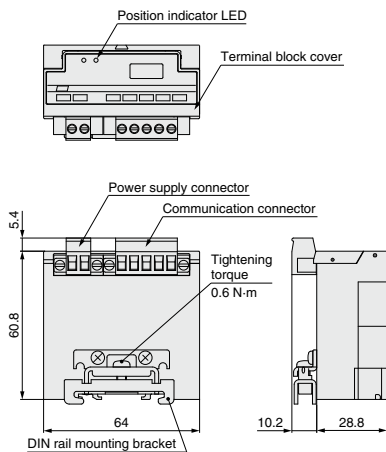

EX122-SMJ1, SCS□

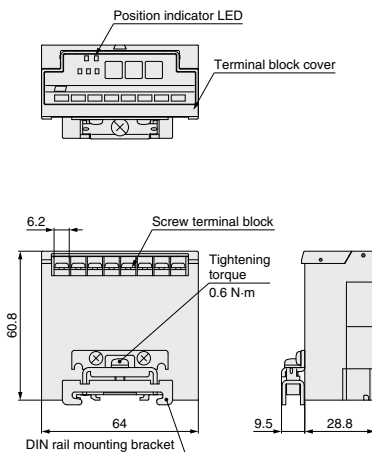

EX122-SCM□

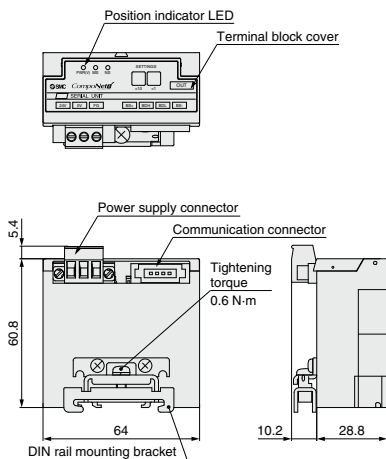

LED Indicator

EX12□-SDN1

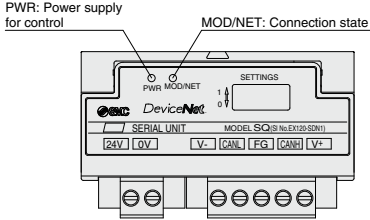

EX12□-SMJ1

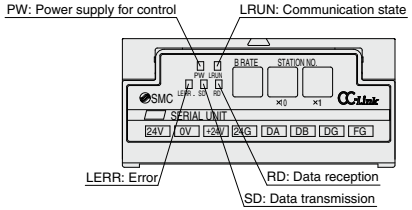

EX12□-SCS□

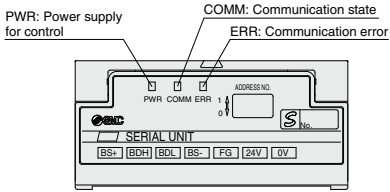

EX12□-SCM□

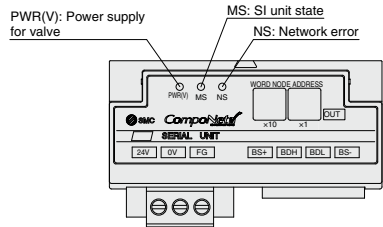

EX120/121/122 Series

Accessories (For EX12□-SCM□)

① Communication Connector

Press-in connector for flat cables
Use this connector for the standard dedicated flat cable.
The communication connector does not come with this product.

EX9-CCM1

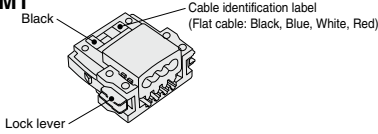

Terminal block connector for round cables (VCTF)
Use this connector for the VCTF cable.
The communication connector does not come with this product.

EX9-CCM2

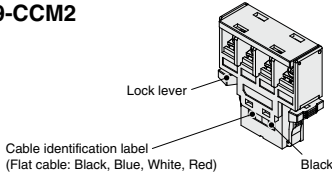

② Power Supply Connector

Straight type power supply connector
This connector is supplied at the time of shipment.

EX9-CP2

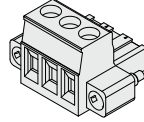

T-branch type power supply connector
This connector is not supplied at the time of shipment.

EX9-CP3

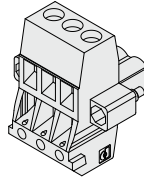

Made to Order

Please contact SMC for detailed specifications and lead times.
Prepare the SI unit and manifold valve (without SI unit) separately, and combine them before use.

① DeviceNet® PNP (Negative common) output, Occupied points: 16 inputs/16 outputs

EX12 0 -SDN1-X2

● Valve interface

0	Plug-in
1	Flat ribbon cable DIN rail mounting
2	Plug-in DIN rail mounting

● Dimensions are the same as those of the standard type.

② DeviceNet® PNP (Negative common) output, Occupied points: 0 inputs/16 outputs

EX12 0 -SDN1-X77

● Valve interface

0	Plug-in
1	Flat ribbon cable DIN rail mounting
2	Plug-in DIN rail mounting

● Dimensions are the same as those of the standard type.

③ S-LINK V compatible NPN (Positive common) 16 outputs

EX120-SSL1-X99

● Dimensions are the same as those of the CC-Link (EX120-SMJ1).

⚠ Specific Product Precautions

Be sure to read this before handling the products. Refer to page 7 for safety instructions and pages 15 to 17 for fieldbus system precautions.

Operating Environment

⚠ Warning

1. Do not use this product in the presence of dust, particles, water, chemicals, and oil. Use around such materials is likely to cause a malfunction or breakage.

■ Trademark

DeviceNet® is a registered trademark of ODVA, Inc.
CompoNet® is a registered trademark of ODVA, Inc.

Fieldbus System (For Output)

EX124/126 Series



Compatible Protocols

DeviceNet[®] CC-Link CompoBus/S

Made to Order CompoNet[®]

- ★ Enclosure IP65 (EX124), IP67 (EX126)
- ★ Maximum 16 outputs

Manifold Solenoid Valves

EX124 Series

VQ2000/4000/5000

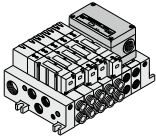

EX126 Series

SY3000/5000/7000

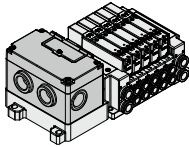

SV1000/2000/3000

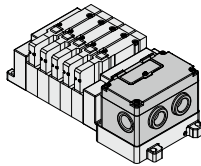

VQC1000/2000/4000/5000

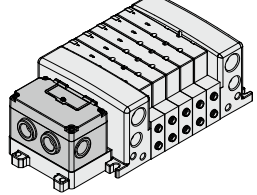

CONTENTS

Fieldbus System (For Output) EX124/126 Series



How to Order SI Unit	p. 1296
Specifications	p. 1297
Dimensions/Parts Description	p. 1298
LED Indicator	p. 1299

Accessories

① Replacement Fuse	p. 1299
② Drip Proof Plug Assembly	p. 1299

Made to Order

① DeviceNet [®] PNP (Negative common), Occupied points: 16 inputs/16 outputs	p. 1300
② DeviceNet [®] PNP (Negative common), Occupied points: 0 inputs/16 outputs	p. 1300
③ CompoNet [®]	p. 1300
④ Signal Cut Block	p. 1300

Specific Product Precautions	p. 1300
------------------------------------	---------

Fieldbus System For Output

EX124/126 Series

How to Order SI Unit

EX124 **U** - **S** **DN1** -

Unit specifications

4	Separate power supply of control and valve Enclosure IP65 Compatible with the VQ valves
----------	---

Mounting specifications

U	Mount a unit to the U side of the manifold
D	Mount a unit to the D side of the manifold

Made to Order (Refer to page 1300.)

Protocol	Output polarity	Occupied points
DeviceNet®	PNP (Negative common)	16 inputs/ 16 outputs
DeviceNet®	PNP (Negative common)	0 inputs/ 16 outputs

Protocol

DN1	DeviceNet®*1
DN1-X26	DeviceNet®*1
MJ1	CC-Link
CS1	OMRON Corp.: CompoBus/S (16 outputs)
CS2	OMRON Corp.: CompoBus/S (8 outputs)

*1 DN1's occupied points are 16 inputs and 16 outputs, while DN1-X26 has 0 inputs and 16 outputs.

EX126 **D** - **S** **MJ1**

Unit specifications

6	Separate power supply of control and valve Enclosure IP65 Compatible with the SY/SV/VQC valves
----------	--

Mounting specifications

D	Mount a unit to the D side of the manifold
----------	--

Protocol

MJ1	CC-Link
------------	---------

Specifications

Common Specifications

Communication	Terminating resistor	Not provided
Internal current consumption (Unit)		100 mA or less
Output	Output type	Sink/NPN (Positive common)
	Load	Solenoid valve with surge voltage suppressor 24 VDC, 2.1 W or less (SMC)
Environmental resistance	Operating temperature range	0 to 55°C (Valve 8 points ON) 0 to 50°C (Valve 16 points ON)
	Operating humidity range	35 to 85%RH (No condensation)
	Withstand voltage	1500 VAC for 1 minute between whole external terminal and enclosure
	Insulation resistance	2 MΩ or more (500 VDC) between whole external terminal and enclosure
Weight		240 g or less
Accessory		4 unit mounting screws (M4 x 10)

Model			EX124□-SDN1	EX124□-SDN1-X26*3
Communication	Applicable system	Protocol	DeviceNet®	DeviceNet®
		Version*1	Release 2.0	
	Communication speed	125 k/250 k/500 kbps		
	Configuration file*2	EDS file		
	I/O occupation area (Inputs/Outputs)	16/16	0/16	
Power supply voltage	For control	11 to 25 VDC		
	For valve	24 VDC +10%/−5%		
Output	Number of outputs	16 points		
	Fail safe	CLEAR	HOLD/CLEAR (Switch setting)	
Environment	Enclosure	IP65		
Standards		CE/UKCA marking		

Model			EX124□-SMJ1	EX124□-SCS1 EX124□-SCS2	EX126D-SMJ1
Communication	Applicable system	Protocol	CC-Link	OMRON Corp.: CompoBus/S	CC-Link
		Version*1	Ver. 1.10	—	Ver. 1.10
	Communication speed	156 k/625 kbps 2.5 M/5 M/10 Mbps	750 kbps	156 k/625 kbps 2.5 M/5 M/10 Mbps	
	Configuration file*2	CSP+ file	—	CSP+ file	
	I/O occupation area (Inputs/Outputs)	32/32 (1 station, remote I/O stations)	SCS1: 0/16 SCS2: 0/8	32/32 (1 station, remote I/O stations)	
Power supply voltage	For control	15 to 30 VDC	14 to 26.4 VDC	15 to 30 VDC	
	For valve		24 VDC +10%/−5%		
Output	Number of outputs	16 points	SCS1: 16 points SCS2: 8 points	16 points	
	Fail safe	CLEAR	HOLD/CLEAR (Switch setting)		
Environment	Enclosure	IP65		IP67	
Standards		CE/UKCA marking			

*1 Please note that the version is subject to change.

*2 The setting file can be downloaded from the SMC website, <https://www.smcworld.com>

*3 Since this is a special product, a manifold part number is not specified. Please consult SMC for the manifold integrated type.

* For detailed specifications other than the above, refer to the operation manual that can be downloaded from SMC website, <https://www.smcworld.com>

EX124/126 Series

Dimensions/Parts Description

EX124□-S□□□

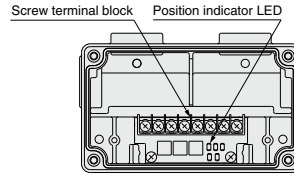
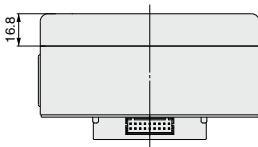
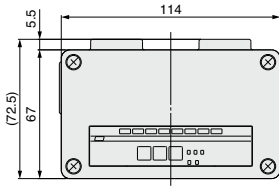
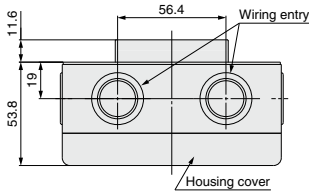

Housing cover diagram

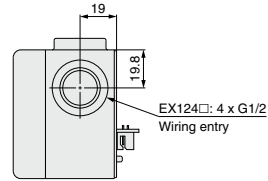

* The housing cover of the EX124U/D-SMJ1 is the same as that of the EX126D-SMJ1.

EX126D-SMJ1

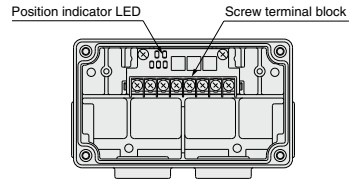
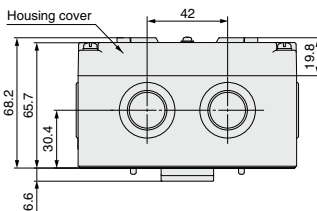
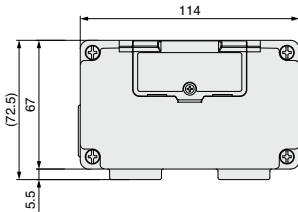
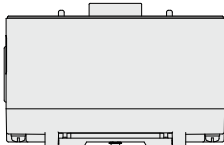

Housing cover diagram

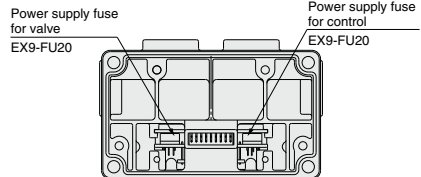
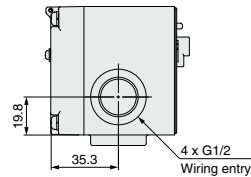

Housing bottom diagram

LED Indicator

EX124□-SDN1

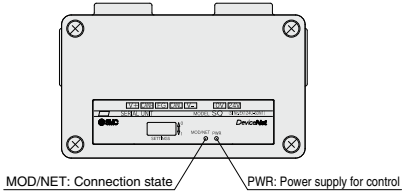

EX124□-SMJ1

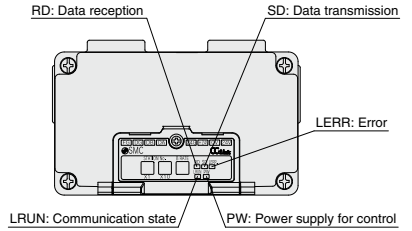

EX124□-SCS□

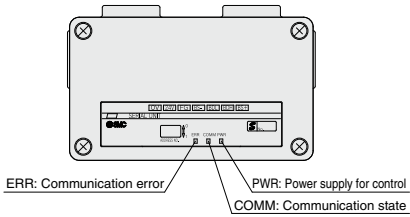

EX126D-SMJ1

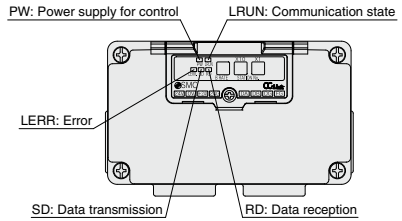

Accessories

① Replacement Fuse

A replacement fuse for the EX126D-SMJ1

EX9-FU20

Applicable model	EX126D-SMJ1
Rated current	2.0 A

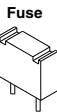

② Drip Proof Plug Assembly

Use when the wiring entry (G1/2) is not being used. Incorrect handling of the wiring entry may allow foreign matter to enter the SI unit, which will lead to a malfunction and damage to the SI unit.

AXT100-B04A

EX124/126 Series

Please contact SMC for detailed specifications and lead times.
Prepare the SI unit, signal cut block, and manifold valve (without SI unit) separately, and combine them before use.



Made to Order

① DeviceNet® PNP (Negative common), Occupied points: 16 inputs*1 /16 outputs

EX124[U]-SDN1-X2

Mounting specifications

U	Mount a unit to the U side of the manifold
D	Mount a unit to the D side of the manifold

• Dimensions are the same as those of the standard type.

*1 The SI unit cannot be connected to an input device but occupies memory areas of 16 input points (2 bytes) as a mirror function of output data. The mirror function is used to transmit output data received by the SI unit as input data exactly as it is.

② DeviceNet® PNP (Negative common), Occupied points: 0 inputs/16 outputs

EX124[U]-SDN1-X77

Mounting specifications

U	Mount a unit to the U side of the manifold
D	Mount a unit to the D side of the manifold

• Dimensions are the same as those of the standard type.

③ CompoNet®

• Please contact SMC for details.

④ Signal cut block

EX9-SC1-8

- A switch unit that forcibly turns OFF the output signal to the valve by means of a toggle switch operation in double 1-station units
- Open the switch guard to prevent misoperation, and then carry out the operation.
- It comes with a safety mechanism which returns the switch to the normal position (AUTO) after the switch guard is closed.
- Enclosure: IP67

Example of connections

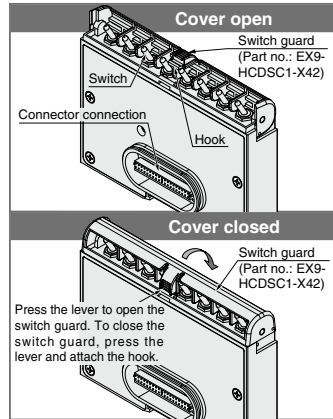
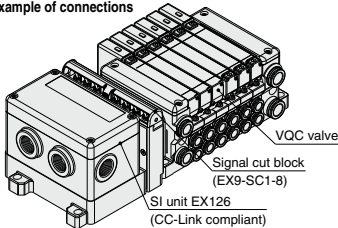

⚠ Specific Product Precautions

Be sure to read this before handling the products.
Refer to page 7 for safety instructions and pages 15 to 17 for fieldbus system precautions.

Operating Environment

⚠ Caution

1. Select the proper type of enclosure according to the operating environment.
IP65/67 is achieved when the following conditions are met.
 - 1) Provide appropriate wiring between all units using electrical wiring cables and communication connectors cables.
 - 2) For wiring, use a G1/2 cable gland.
 - 3) Appropriately mount each unit and valve manifold.
 - 4) Be sure to install a drip proof plug assembly (AXT100-B04A) on each unused connector. This is to prevent the risk of the SI unit malfunctioning or breaking down.
If using in an environment that is exposed to water splashes, please take measures such as using a cover.

■ Trademark

DeviceNet® is a registered trademark of ODVA, Inc.
CompoNet® is a registered trademark of ODVA, Inc.

Fieldbus System (For Output)

EX140 Series



Compatible Protocols

DeviceNet CC-Link CompoBus/S

- ★ Thinner unit with low height
- ★ Maximum 16 outputs

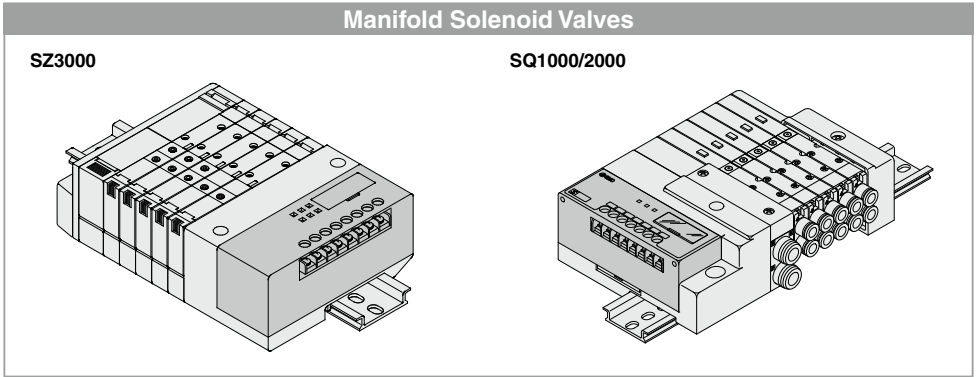

CONTENTS

Type 1 Output type for solenoid valves

Fieldbus System (For Output)

EX140 Series



How to Order SI Unit	p. 1302
Specifications	p. 1302
Dimensions/Parts Description	p. 1303
LED Indicator	p. 1304
Specific Product Precautions	p. 1304

Fieldbus System For Output

EX140 Series



How to Order SI Unit

EX140-S DN1

• Protocol

DN1	DeviceNet®
MJ1	CC-Link
CS1	OMRON Corp.: CompoBus/S (16 outputs)
CS2	OMRON Corp.: CompoBus/S (8 outputs)

Specifications

Model		EX140-SDN1	EX140-SMJ1	EX140-SCS1 EX140-SCS2
Communication	Applicable system	DeviceNet®	CC-Link	OMRON Corp.: CompoBus/S
	Protocol	DeviceNet®	CC-Link	OMRON Corp.: CompoBus/S
	Version*1	Release 2.0	Ver. 1.10	—
	Communication speed	125 k/250 k/500 kbps	156 k/625 kbps 2.5 M/5 M/10 Mbps	750 kbps
	Configuration file*2	EDS file	CSP+ file	—
I/O occupation area (Inputs/Outputs)		0/16	32/32 (1 station, remote I/O stations)	SCS1: 0/16 SCS2: 0/8
	Terminating resistor		Not provided	
Power supply voltage	For control	11 to 25 VDC	15 to 30 VDC	14 to 26.4 VDC
	For valve		24 VDC +10%/−5%	
Internal current consumption (Unit)			100 mA or less	
Output	Output type		Sink/NPN (Positive common)	
	Number of outputs		16 outputs	SCS1: 16 outputs SCS2: 8 outputs
	Load		Solenoid valve with surge voltage suppressor 24 VDC, 2.1 W or less (SMC)	
	Fail safe		HOLD/CLEAR (Switch setting)	
Environmental resistance	Enclosure		IP20	
	Operating temperature range		0 to 55°C (Valve 8 points ON) 0 to 50°C (Valve 16 points ON)	
	Operating humidity range		35 to 85%RH (No condensation)	
	Withstand voltage		1500 VAC for 1 minute between whole external terminal and enclosure	
	Insulation resistance		2 MΩ or more (500 VDC) between whole external terminal and enclosure	
Standards			CE/UKCA marking	
Weight			80 g or less	
Accessory		Communication connector 1 pc., Power supply connector 1 pc.		—

*1 Please note that the version is subject to change.

*2 The setting file can be downloaded from SMC website, <https://www.smcworld.com>

* For detailed specifications other than the above, refer to the operation manual that can be downloaded from SMC website, <https://www.smcworld.com>

Dimensions/Parts Description

EX140-SDN1

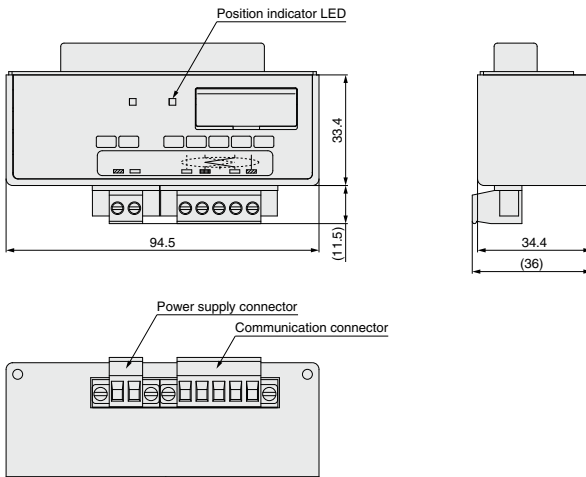

EX140-SMJ1, SCS□

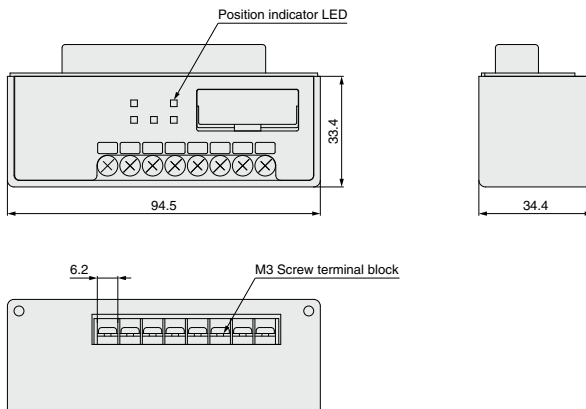

EX140 Series

LED Indicator

EX140-SDN1

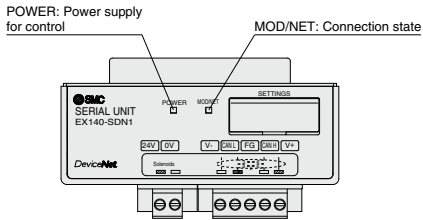

EX140-SMJ1

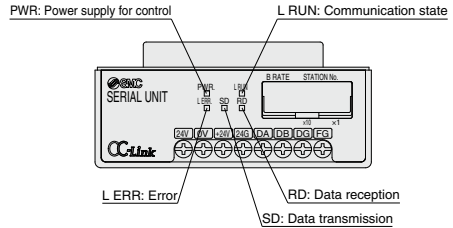

EX140-SCS1

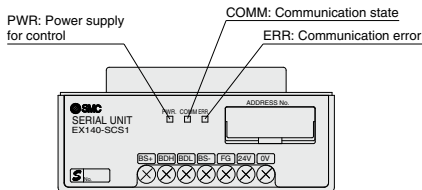

⚠ Specific Product Precautions

Be sure to read this before handling the products. Refer to page 7 for safety instructions and pages 15 to 17 for fieldbus system precautions.

Operating Environment

⚠ Warning

1. Do not use this product in the presence of dust, particles, water, chemicals, and oil. Use around such materials is likely to cause a malfunction or breakage.

■ Trademark
DeviceNet® is a registered trademark of ODVA, Inc.

Type 1 Output type for solenoid valves

Fieldbus System (For Output)

EX180 Series

Compatible Protocols

DeviceNet CC-Link

Made to Order AnyWireASLINK



- ★ Thinner unit with low height
- ★ Maximum 32 outputs

Manifold Solenoid Valves

SY3000/5000/7000

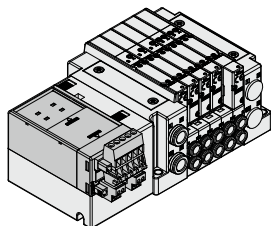

SJ2000/3000

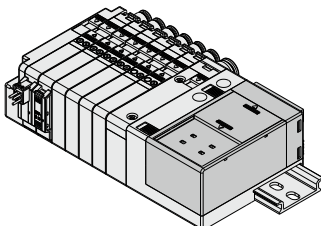

S0700

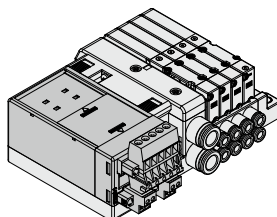

CONTENTS

Type 1 Output type for solenoid valves

Fieldbus System (For Output)

EX180 Series

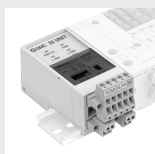

How to Order SI Unit	p. 1306
Specifications	p. 1306
Dimensions/Parts Description	p. 1307
LED Indicator	p. 1308

Accessories

① Communication Connector	p. 1308
② Power Supply Connector	p. 1308

Made to Order

① AnyWireASLINK NPN (Positive common), 32 outputs	p. 1309
--	---------

Specific Product Precautions	p. 1309
------------------------------------	---------

Fieldbus System For Output

EX180 Series



How to Order SI Unit

EX180-S **DN3** □ - □

Protocol

DN3	DeviceNet® (32 points Sink/NPN (Positive common))
DN4	DeviceNet® (16 points Sink/NPN (Positive common))
DN5	DeviceNet® (32 points Source/PNP (Negative common))
DN6	DeviceNet® (16 points Source/PNP (Negative common))
MJ3	CC-Link (32 points Sink/NPN (Positive common))
MJ5	CC-Link (32 points Source/PNP (Negative common))

Made to Order (Refer to page 1309.)

Protocol
AnyWireASLINK

Communication connector type

NII	T-branch type
A	Straight type

* Communication and power supply connectors are included.

Specifications

Model		EX180-SDN3 EX180-SDN4	EX180-SDN5 EX180-SDN6	EX180-SMJ3	EX180-SMJ5
Communication	Applicable system	DeviceNet®		CC-Link	
	Protocol Version*1	Release 2.0		Ver. 1.10	
	Communication speed	125 k/250 k/500 kbps		156 k/625 kbps 2.5 M/5 M/10 Mbps	
	Configuration file*2	EDS file		CSP+ file	
	I/O occupation area (Inputs/Outputs)	SDN3: 0/32 SDN4: 0/16	SDN5: 0/32 SDN6: 0/16	32/32 (1 station)	
	Terminating resistor	Not provided		Built into the unit (Switch setting, 110 Ω)	
Power supply voltage	For control	11 to 25 VDC		24 VDC ±10%	
	For valve	24 VDC ±10%/−5%			
Internal current consumption (Unit)		0.1 A or less			
Output	Output type	Sink/NPN (Positive common)	Source/PNP (Negative common)	Sink/NPN (Positive common)	Source/PNP (Negative common)
	Number of outputs	SDN3: 32 outputs SDN4: 16 outputs	SDN5: 32 outputs SDN6: 16 outputs	32 outputs	
	Load	SY3000/5000/7000, SJ2000/3000, S0700 series manifold valves			
	Fail safe	HOLD/CLEAR (Switch setting)			
Environmental resistance	Enclosure	IP20			
	Operating temperature range	−10 to 50°C			
	Operating humidity range	35 to 85%RH (No condensation)			
	Withstand voltage	500 VAC for 1 minute between whole external terminal and FG			
	Insulation resistance	10 MΩ or more (500 VDC) between whole external terminal and FG			
Standards	CE/UKCA marking, UL (CSA)				
Weight	110 g or less (including accessory)				
Accessory	Communication connector 1 pc., Power supply connector 1 pc.		Communication connector 1 pc., Power supply connector 2 pcs.		

*1 Please note that the version is subject to change.

*2 The setting file can be downloaded from SMC website, <https://www.smcworld.com>

* For detailed specifications other than the above, refer to the operation manual that can be downloaded from SMC website, <https://www.smcworld.com>

* The EX180-SDN1□/2□ cannot be mounted on the manifold for the EX180-SDN3□/4□/5□/6□. Additionally, the EX180-SDN3□/4□/5□/6□ cannot be mounted on the manifold for the EX180-SDN1□/2□.

* The EX180-SMJ1□ cannot be mounted on the manifold for the EX180-SMJ3□/5□. Additionally, the EX180-SMJ3□/5□ cannot be mounted on the manifold for the EX180-SMJ1□.

Dimensions/Parts Description

EX180-SDN

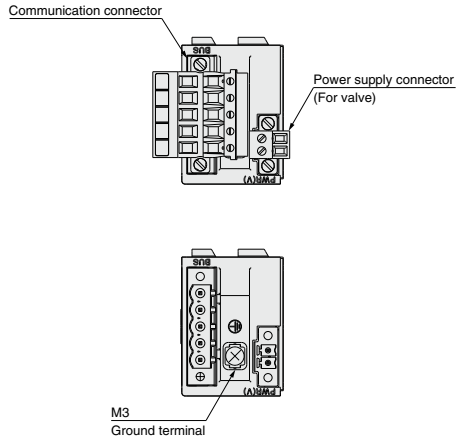
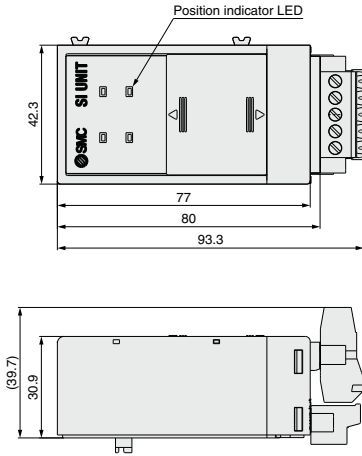

Before mounting connector (accessory)

EX180-SMJ

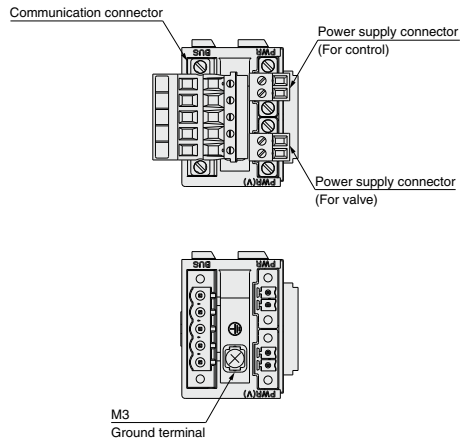
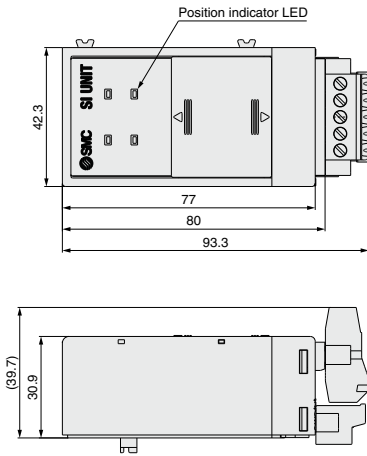

Before mounting connector (accessory)

EX180 Series

LED Indicator

EX180-SDN□

PWR(V): Power supply for valve

PWR: Power supply for control

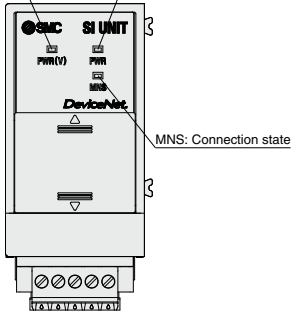

EX180-SMJ□

PWR(V): Power supply for valve

PWR: Power supply for control

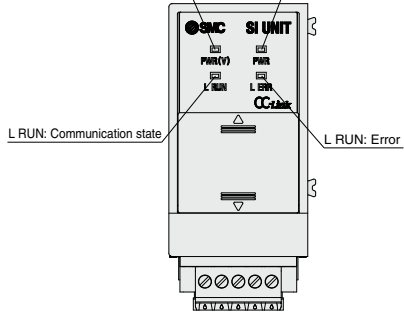

Accessories

① Communication Connector

Connector for the network cable
This connector is supplied at the time of shipment.

EX180-C **DN** | **1**

Communication protocol

DN	For EX180-SDN□
MJ	For EX180-SMJ□

Communication connector type

1	T-branch type
2	Straight type

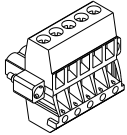

EX180-C□□1

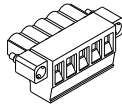

EX180-C□□2

② Power Supply Connector

Connector for power supply
This connector is supplied at the time of shipment.

EX180-CP1



Made to Order

Please contact SMC for detailed specifications and lead times.
Prepare the SI unit and manifold valve (without SI unit) separately, and combine them before use.

① AnyWireASLINK NPN (Positive common), 32 outputs

EX180-SAW1-X237

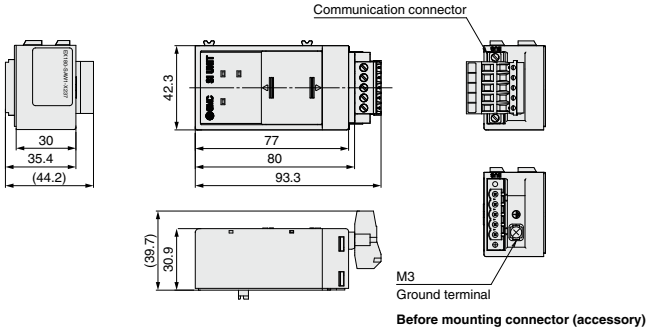

⚠ Specific Product Precautions

Be sure to read this before handling the products. Refer to page 7 for safety instructions and pages 15 to 17 for fieldbus system precautions.

Operating Environment

⚠ Warning

1. Do not use this product in the presence of dust, particles, water, chemicals, and oil. Use around such materials is likely to cause a malfunction or breakage.

■ **Trademark**

DeviceNet® is a registered trademark of ODVA, Inc.