

Thermo-dryer

IDH□ Series

With air temperature adjustment function

Stable supply of temperature and pressure controlled dry clean air!



Possible to supply compressed air with the same conditions and quality regardless of the season.

Application example

Supplying compressed air with constant conditions to air bearings mounted on the tool.

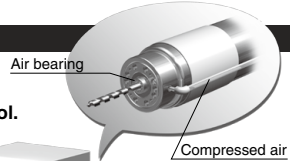

Air flow capacity (L/min[ANR])

IDH□4: 100 to 500

IDH□6: 200 to 800

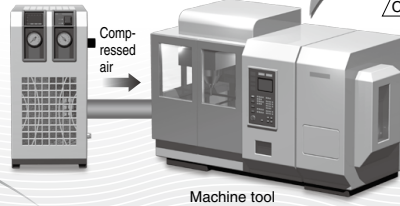

All-in-One

Temperature control
(Heater)

Outlet air temperature adjustment range:

15 to 30°C

Outlet air temperature stability:

±0.1°C^{*1}

Pressure regulation
(Regulator)

Outlet air set pressure range:

0.15 to 0.85 MPa

Dehumidification
(Dryer)

Outlet air pressure dew point:

10°C

Cleaning
(Filter)

Built-in filter specifications^{*2}

Nominal filtration rating:

0.01 μm

Outlet oil mist concentration:

MAX. 0.01 mg/m³ [ANR]

(≈0.008 ppm)

Outlet cleanliness:

Particles of 0.3 μm or more:

3.5 particles/L [ANR] or less

^{*1} Performance when the operation of each part is stable without fluctuations in operating conditions and power supply.
^{*2} Performance of the built-in filter, which depends on the inlet air conditions.



Power supply available all over the world Single-phase 100 VAC, 200 VAC, 230 VAC (50/60 Hz)

| Model | Air flow capacity (L/min [ANR]) | Outlet air temperature adjustment range (°C) | Outlet air set pressure range (MPa) | Outlet air temperature stability (°C) | Filter nominal filtration rating | Temperature control method | Port size |
|-------|---------------------------------|--|-------------------------------------|---------------------------------------|---------------------------------------|---------------------------------|-----------|
| IDH□4 | 100 to 500 | 15 to 30 | 0.15 to 0.85 | ±0.1 | 0.01 μm (99.9% filtration efficiency) | Heater operation PID control | Rc3/8 |
| IDH□6 | 200 to 800 | | | | | | Rc1/2 |

Thermo-dryer

Compact,
Space saving

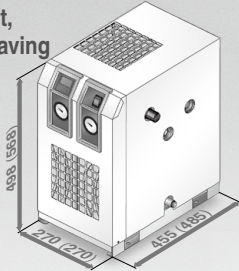

*For IDH□4
Dimensions in brackets indicate
for IDH□6. Unit: mm

Installation close to a
wall is possible.

Installation close to a
wall is possible with the
ventilation holes on the front
and top sides.

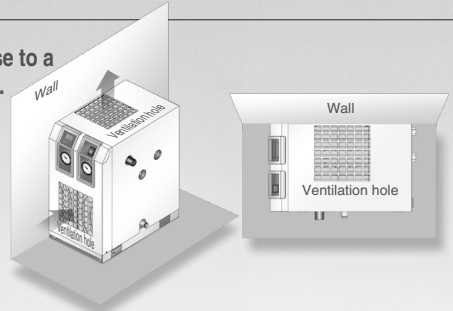

Convenient Functions

Power failure auto-restart function

Even if operation is stopped by unexpected power failure, once the power supply is recovered, the operation will start automatically.

*If an instantaneous power failure occurs, the operation may restart after a few minutes.

Auto-tuning (A-T) function

The control set values (PID) are automatically set.

Control temperature failure alarm

If the temperature exceeds the set temperature by an arbitrary amount, an error signal will be generated.

*At shipment, if the control temperature exceeds or goes under the set temperature by $\pm 5^{\circ}\text{C}$, an error signal will be generated.

Key-lock function

The set value is protected so it will not be changed even if keys are touched by mistake or setting is changed.

Large digital display



| Display | Function |
|---------|--|
| ① PV | Display the air temperature the outlet of the dryer. |
| ② SV | Display the set value for air temperature at the outlet of the dryer. |
| ③ OUT1 | Lights up when the temperature adjustment heater is operating. |
| ④ Ev1 | Lights up when there is a temperature abnormality |
| ⑤ | USER Key Press once on the PV/SV display (operation screen) to switch between SV and MV displays. |
| ⑥ SEL | This key is used to change and fix the set value. |
| ⑦ < | This key is used to select the digit when changing values. |
| ⑧ | Press to decrease the set temperature and set values, and press to increase them. |

Regulator knob



Built-in filter

The discharge of drainage and element replacement timing can be checked visually.

Filter② (AME)

- Super Mist Separator**
- Nominal filtration rating:
0.01 μm (99.9% filtration efficiency)
- Outlet oil mist concentration:
MAX. 0.01 mg/m^3 [ANR]
(≈ 0.008 ppm)
- Outlet oil mist concentration:
Particles of 0.3 μm or
more: 3.5 particles/L
[ANR] or less



Pressure adjustment knob

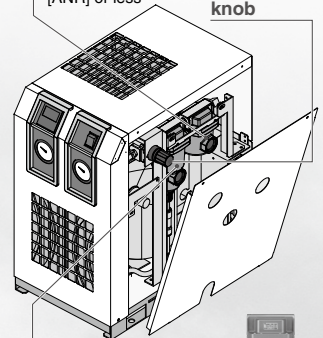

Filter① (AMH)

- Micro Mist Separator with Pre-filter**
- Nominal filtration rating:
0.01 μm (99.9% filtration efficiency)
- Outlet oil mist concentration:
MAX. 0.1 mg/m^3 [ANR] (≈ 0.08 ppm)

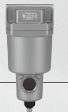

Dustproof filter standard equipment

Built-in earth leakage breaker

Remote operation, stop, error signal output functions are provided.

It is possible to achieve centralized control in a factory with remote operation, stop and error signal output functions.

- It is possible to operate and stop the dryer remotely. (Note that the dryer should be rested for at least 3 minutes after it is stopped, and should be operated for at least 10 minutes continuously.)
- It is possible to receive operation and error signals.

It is possible to synchronize the operation of the dryer with the external air compressor operation to prevent people from forgetting to turn it off and contribute to energy saving.

Remote operation application examples

Operating together with compressor

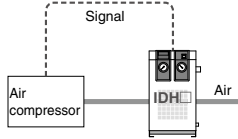

Centralized control

Several units can be controlled together with PLC.

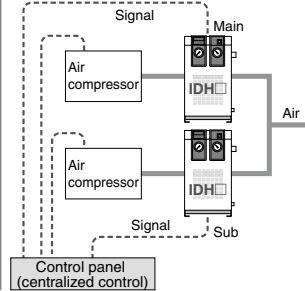

Switching operation of the dryer

If the main dryer is stopped during 24-hour operation by an emergency stop signal, the error signal is detected and sub dryer is operated.

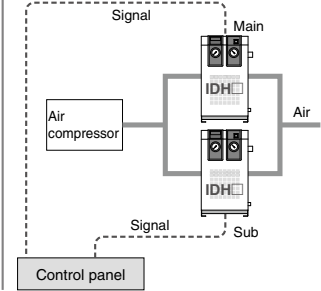

Application Examples

Measuring machine

- Cooling of air bearing
- Assisting lifting of table
- Cooling of linear scale

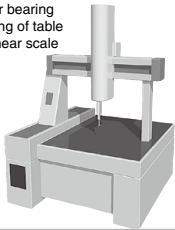

Cooling of die

- Cooling of laser irradiation part

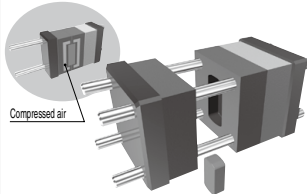

Semiconductor-related manufacturing equipment

- Supplying air to air bearing
- Temperature control of glass substrate

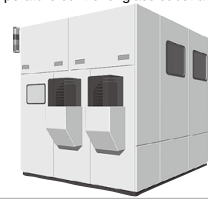

Machine tool

- Supplying air to air bearing

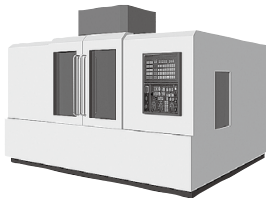

Powder coating

- Temperature control of paint

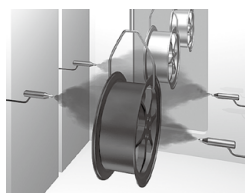

Food machinery

- Eliminating humidity/cooling of hopper
- Temperature control in rice/wheat chamber



Other Applications

Laser beam machine

- Cooling of laser irradiation part

UV curing device

- (printing, painting, bonding and sealing)
- Cooling of UV lamp

X-ray (digital) apparatus

- Temperature control of X-ray tube and X-ray light receiving section

Electronic microscope

- Temperature control of electron beam irradiation part

Laser marker

- Cooling of laser irradiation part

Ultrasonic wave inspection apparatus

- Temperature control of ultrasonic wave laser part

Linear motor

- Temperature control of moving coil

Packaging machine

- (sealing of film and paper package)
- Cooling of work pieces for bonding

Shrink fitting machine

- Cooling of workpiece

*The effectiveness is not guaranteed in all applications. Please check whether the dryer can be used in the actual application.

IDH□ Series

Model Selection

The settable range of the outlet air set temperature varies depending on the operating conditions. Be sure to select the model in accordance with the selection method below.

1 Selection by air flow

Selection Example ①

| Condition | Data symbol |
|-----------------------------------|-------------|
| Inlet air temperature 20°C | A |
| Ambient temperature 25°C | B |
| Outlet air pressure dew point 3°C | C |
| Inlet air pressure 1 MPa | D |
| Outlet air set temperature 20°C | F |
| Air flow 300 L/min [ANR] | E |

IDH□4 or IDH□6 are selected from **Data B**.
 ➔ Move to Step 2.

Selection Example ②

| Condition | Data symbol |
|-----------------------------------|-------------|
| Inlet air temperature 30°C | A |
| Ambient temperature 30°C | B |
| Outlet air pressure dew point 5°C | C |
| Inlet air pressure 0.5 MPa | D |
| Outlet air set temperature 25°C | F |
| Air flow 500 L/min [ANR] | E |

IDH□4 or IDH□6 are selected from **Data B**.
 ➔ Move to Step 2.

2 Read the correction factors.

Input the operating conditions in the table below and read the correction factors from the tables of **Data A** to **D**.

| Condition | Data symbol | Correction factor |
|-----------------------------------|-------------|-------------------|
| Inlet air temperature 20°C | A | 1.36 |
| Ambient temperature 25°C | B | 1.07 |
| Outlet air pressure dew point 3°C | C | 0.50 |
| Inlet air pressure 1 MPa | D | 1.16 |
| Outlet air set temperature 20°C | F | — |

Input the operating conditions in the table below and read the correction factors from the tables of **Data A** to **D**.

| Condition | Data symbol | Correction factor |
|-----------------------------------|-------------|-------------------|
| Inlet air temperature 30°C | A | 1.11 |
| Ambient temperature 30°C | B | 1.00 |
| Outlet air pressure dew point 5°C | C | 0.67 |
| Inlet air pressure 0.5 MPa | D | 0.88 |
| Outlet air set temperature 25°C | F | — |

3 Check the coefficient.

Correction factor = $1.36 \times 1.07 \times 0.50 \times 1.16 = 0.84$

Correction factor = $1.11 \times 1 \times 0.67 \times 0.88 = 0.65$

4 Calculate the corrected air flow capacity.

Corrected air flow capacity = $300 \div 0.84 = 355$ L/min [ANR]

Corrected air flow capacity = $500 \div 0.65 = 764$ L/min [ANR]

5 Selection by corrected air flow capacity

In case of Example ①, the next model is selected from **Data E**: Air flow capacity.
 Applicable model: IDH□4

In case of Example ②, the next model is selected from **Data E**: Air flow capacity.
 Applicable model: IDH□6

6 Check the outlet air set temperature.

Check the outlet air set temperature from Graph 1 of **Data F**. Check the outlet air set temperature from the intersection point of the curve indicating a pressure dew point of 3°C and an air flow capacity of 300 L/min [ANR].
 ➔ It is possible to confirm that the outlet air set temperature can be set up to 29°C.

Check the outlet air set temperature from Graph 2 of **Data F**. Check the outlet air set temperature from the intersection point of the curve indicating a pressure dew point of 5°C and an air flow capacity of 500 L/min [ANR].
 ➔ It is possible to confirm that the outlet air set temperature can be set up to 29°C.

7 Selection result

The model selected in Step 1 or 5 can be used.

Selection result: IDH□4

The model selected in Step 1 or 5 can be used.

Selection result: IDH□6

8 Selection of accessories

- Select the built-in products. (Refer to page 190.)
- Select the option. (Refer to page 190.)

- Select the built-in products. (Refer to page 190.)
- Select the option. (Refer to page 190.)

Correction Factors

Data A Inlet Air Temperature

| Inlet air temperature (°C) | Correction factor |
|----------------------------|-------------------|
| 20 | 1.36 |
| 25 | 1.24 |
| 30 | 1.11 |
| 35 | 1.00 |
| 40 | 0.87 |

Data C Outlet Air Pressure Dew Point

| Outlet air pressure dew point (°C) | Correction factor |
|------------------------------------|-------------------|
| 3 | 0.50 |
| 5 | 0.67 |
| 7 | 0.85 |
| 10 | 1.00 |

Data E Air Flow Capacity

| Model | Air flow capacity (L/min [ANR]) | | | | | | | |
|-------|---------------------------------|-----|-----|-----|-----|-----|-----|-----|
| | 100 | 200 | 300 | 400 | 500 | 600 | 700 | 800 |
| IDH□4 | | | | | | | | |
| IDH□6 | | | | | | | | |

Data B Ambient Temperature

| Ambient temperature (°C) | Correction factor |
|--------------------------|-------------------|
| 15 | 1.27 |
| 20 | 1.17 |
| 25 | 1.07 |
| 30 | 1.00 |
| 35 | 0.87 |

Data D Inlet Air Pressure

| Inlet air pressure (MPa) | | Correction factor | |
|--------------------------|------|-------------------|------|
| 0.3 | 0.72 | 0.7 | 1.00 |
| 0.4 | 0.81 | 0.8 | 1.06 |
| 0.5 | 0.88 | 0.9 | 1.11 |
| 0.6 | 0.95 | 1.0 | 1.16 |

Selection Example ③

| Condition | Data symbol | |
|-------------------------------|-----------------|----------|
| Inlet air temperature | 25°C | A |
| Ambient temperature | 25°C | B |
| Outlet air pressure dew point | 10°C | C |
| Inlet air pressure | 0.7 MPa | D |
| Outlet air set temperature | 30°C | F |
| Air flow | 700 L/min [ANR] | E |

IDH 6 is selected from Data **E**.

➡ Move to Step **2**.

Selection Example ④

| Condition | Data symbol | |
|-------------------------------|----------------|----------|
| Inlet air temperature | 30°C | A |
| Ambient temperature | 25°C | B |
| Outlet air pressure dew point | 10°C | C |
| Inlet air pressure | 1 MPa | D |
| Outlet air set temperature | 20°C | F |
| Air flow | 80 L/min [ANR] | E |

Air flow of 80 L/min is outside of the range of air flow capacity.

Input the operating conditions in the table below and read the correction factors from the tables of Data **A** to **F**.

| Condition | Data symbol | Correction factor |
|-------------------------------|-------------|-------------------|
| Inlet air temperature | 25°C | A 1.24 |
| Ambient temperature | 25°C | B 1.07 |
| Outlet air pressure dew point | 10°C | C 1.00 |
| Inlet air pressure | 0.7 MPa | D 1.00 |
| Outlet air set temperature | 30°C | F — |

| Condition | Data symbol | Correction factor |
|-------------------------------|-------------|-------------------|
| Inlet air temperature | — | — |
| Ambient temperature | — | — |
| Outlet air pressure dew point | — | — |
| Inlet air pressure | — | — |
| Outlet air set temperature | — | — |

Correction factor = $1.24 \times 1.07 \times 1 \times 1 = 1.33$

It is not necessary to calculate the factor.

If the correction factor is 1 or more, it is not necessary to calculate the corrected air flow capacity.

➡ Move to Step **3**.

Check the outlet air set temperature from Graph 2 of Data **F**. Check the outlet air set temperature from the intersection point of the curve indicating a pressure dew point of 10°C and an air flow capacity of 700 L/min [ANR].

➡ It is possible to confirm that the outlet air set temperature can be set up to 27°C.

It is not possible to control the required outlet air set temperature. Review the operating conditions.

It is not possible to control the required outlet air set temperature. Review the operating conditions.

Data **F** Maximum Settable Air Temperature

Graph 1: IDH 4

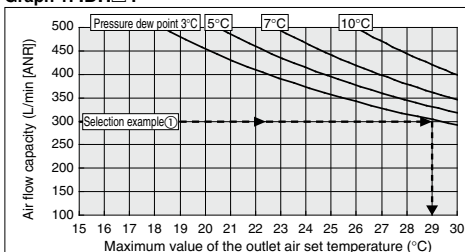

Graph 2: IDH 6

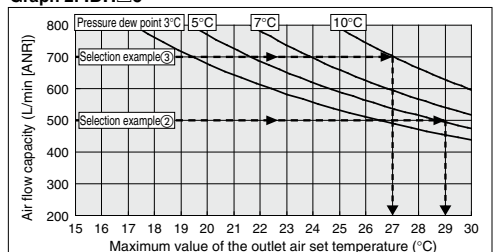

[Note] Select so that it does not exceed the maximum air flow capacity of each model (IDH 4: 500 L/min, IDH 6: 800 L/min).

Refrigerant R134a (HFC)

IDH Series



How to Order

For use in Japan

IDH 6 - 10 -

For use in Europe and Southeast Asia

IDHA 6 - 23 -

Size

| Size | Rated air flow capacity | Air compressor size |
|------|-------------------------|---------------------|
| 4 | 400 L/min [ANR] | 3.7 kW |
| 6 | 600 L/min [ANR] | 5.5 kW |

Option

| Option | Description |
|--------|--|
| Nil | None (Standard) |
| E | Auto drain normally closed |
| G | With Chinese labels and a Chinese operation manual |

* When multiple options are combined, indicate symbols in alphabetical order.

Voltage

| Symbol | Voltage | Specification |
|--------|--------------------------------|--------------------------------------|
| 10 | Single-phase 100 VAC (50/60Hz) | For use in Japan |
| 20 | Single-phase 200 VAC (50/60Hz) | For use in Europe and Southeast Asia |
| 23 | Single-phase 230 VAC (50/60Hz) | |

Combination of built-in products

| Symbol | Regulator | Filter① (AMH) | Filter② (AME) |
|--------|-----------|---------------|---------------|
| Nil | ● | ● | ● |
| A | ● | ● | — |
| B | ● | — | — |

Optional Specifications

E Option symbol

Auto drain normally closed

The auto drain which exhausts dehumidified drainage and the auto drain on the built-in filter are changed to the "normally closed" specification. Recommended for small flow rate (100 to 150 L/min).

| Description | Filter details | Filter size | |
|----------------------|--|-------------|-------------|
| | | IDH4, IDHA4 | IDH6, IDHA6 |
| Filter① (AMH) | Micro mist separator with pre-filter · Nominal filtration rating: 0.01 μm (99.9% filtration efficiency) · Outlet oil mist concentration: MAX. 0.1 mg/m ³ [ANR] (≈0.08 ppm) | AMH250C | AMH350C |
| Filter② (AME) | Super mist separator · Nominal filtration rating: 0.01 μm (99.9% filtration efficiency) · Outlet oil mist concentration: MAX. 0.01 mg/m ³ [ANR] (≈0.008 ppm) · Cleanliness at outlet: Particles of 0.3 μm or more: 3.5 particles/L [ANR] or less | AME250C | AME350C |

Construction (Pneumatic/Refrigerant Circuit)

Pneumatic circuit

Hot and humid air entering this product is cooled down by the cooler. The moisture condensed at this time is separated by the drain separator and exhausted automatically. The pressure of the dry air is adjusted by the regulator, and oil mist and solid particles are separated by the micro mist separator with pre-filter and super mist separator. ^(Note)The temperature of the dry and high purity air ^(Note)is adjusted by the heater and supplied to the outlet side.
Note) The type without filter is not applicable.

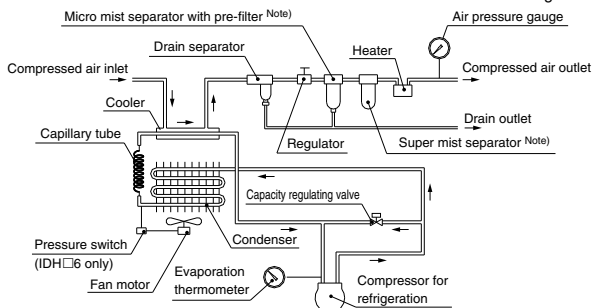

Refrigerant circuit

The HFC gas contained in the refrigerant circuit is compressed by the compressor, and cooled and liquefied by the condenser. When passing through the capillary tube, the HFC gas is regulated and its temperature decreases. While passing through the cooler part, it evaporates rapidly, taking the heat from the compressed air, and is sucked in by the compressor. The capacity regulating valve opens when the compressed air has been cooled sufficiently, and prevents condensed water from being frozen by excessive cooling.

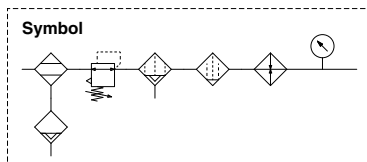

Standard Specifications

| Specifications | | Model | IDH4-10□ | IDH4-20□ | IDHA4-23□ | IDH6-10□ | IDH6-20□ | IDHA6-23□ |
|--|--|--|------------------------------------|------------------------------------|------------------------------------|------------------------------------|------------------------------------|-----------|
| Note 3) Operating range | Fluid | Compressed air | | | | | | |
| | Air flow capacity <small>Note 1)</small> | 100 to 500 L/min [ANR] <small>Note 9)</small> | | | 200 to 800 L/min [ANR] | | | |
| | Inlet air temperature | 5 to 40°C | | | | | | |
| | Inlet air pressure | 0.3 to 1.0 MPa | | | | | | |
| | Ambient temperature | 15 to 35°C (Relative humidity 85% or less) | | | | | | |
| | Outlet air set pressure range <small>Note 2)</small> | 15 to 30°C | | | | | | |
| Rated conditions | Air flow capacity | 400 L/min [ANR] | | | | | 600 L/min [ANR] | |
| | Inlet air pressure | 0.7 MPa | | | | | | |
| | Inlet air temperature | 35°C | | | | | | |
| | Ambient temperature | 30°C | | | | | | |
| | Outlet air set temperature | 30°C | | | | | | |
| | Outlet air pressure dew point | 10°C | | | | | | |
| Note 4) Rated performance | Outlet air temperature stability <small>Note 5)</small> | ±0.1°C (This may vary depending on the conditions.) | | | | | | |
| | Outlet air temperature display accuracy | ±0.5°C (including accuracy of the sensor) | | | | | | |
| | Power supply <small>Note 6)</small> | Single-phase 100 VAC (50/60 Hz) | Single-phase 200 VAC (50/60 Hz) | Single-phase 230 VAC (50/60 Hz) | Single-phase 100 VAC (50/60 Hz) | Single-phase 200 VAC (50/60 Hz) | Single-phase 230 VAC (50/60 Hz) | |
| Electric specifications | Operating current | 4.2 A | 2.1 A | 2.1 A | 9.4 A | 4.8 A | 4.8 A | |
| | Earth leakage breaker capacity | 10 A | 5 A | 5 A | 15 A | 10 A | 10 A | |
| | Compressor input | 180/200 W 50/60 Hz | | | 385/440 W 50/60 Hz | | | |
| | Heater input | 220 W | | | 420 W | | | |
| Built-in filter specifications <small>Note 7)</small> | Nominal filtration rating | 0.01 μm (99.9% filtration efficiency) | | | | | | |
| | Cleanliness of the filter outlet side | Particles of 0.3 μm or more: 3.5 particles/L [ANR] or less | | | | | | |
| Temperature control method | | Heater operation, PID control | | | | | | |
| Refrigerant type/Refrigerant charge | | R134a/0.14 kg | | | | R134a/0.26 kg | | |
| Noise level (reference value) <small>Note 8)</small> | | 52 dB(A) | | | | 55 dB(A) | | |
| Weight | | 26 kg | | | | 37 kg | | |
| Applicable drain tube O.D. | | 10 mm | | | | | | |
| Applicable directive | | CE/UKCA Marked | | | | | | |

Note 1) ANR is the value at 20°C, atmospheric pressure, and relative humidity of 65%.
 Note 2) About 10 minutes are required until the temperature becomes stable after setting the temperature.
 Note 3) The upper limit of the settable outlet air temperature varies depending on the conditions even within the operating range. Be sure to read the selection document before selecting the models.
 Note 4) Performance when the operation of each part is stable without fluctuations in operating conditions and power supply.
 If the air flow capacity is beyond its specified range or if the air flows intermittently, the outlet air temperature range or temperature stability may not be satisfied. (If this happens, install a purge line and flow the compressed air continuously.)
 Note 5) In case, the outlet air temperature is set in the range of the ambient temperature +/−5 deg.C.

Note 6) Keep the voltage within -5 to +10% of the rated voltage. If there is voltage fluctuation, the outlet air temperature stability may decrease. So if highly accurate temperature adjustment is required, please use a stable power supply to make the voltage fluctuation smaller.
 Note 7) The specification changes depending on the cleanliness of the inlet side air. It may take time until the cleanliness of the filter outlet side air stabilizes immediately after start of operation. The filter performance only applies to the built-in type filter.
 Note 8) 1 m in front of the product, 1 m in height, without load, stable conditions
 Note 9) Customers considering operating the product at an air flow capacity of 100 L/min (ANR) or less should select the special order IDH□□□□-EX120 with a min. air flow capacity of 30 L/min (ANR). However, keep in mind that the ambient temperature and outlet air temperature adjustment range are from 20 to 30°C.

Output Signal

Specifications

| Description | Terminal no. | Description of operation | Contact capacity | Minimum load |
|--|--------------|---|--|--------------|
| Operating signal N.O. (a contact) | 1-2 | Close after 10 minutes of operation | Resistance load 2 A, Induction load 80 VA, Lamp load 100 W | 5 VDC 2 mA |
| Error signal N.C. (b contact) | 3-4 | Open at an emergency stop or set temperature error | | |
| Error signal N.O. (a contact) | 4-5 | Close at an emergency stop or set temperature error | | |

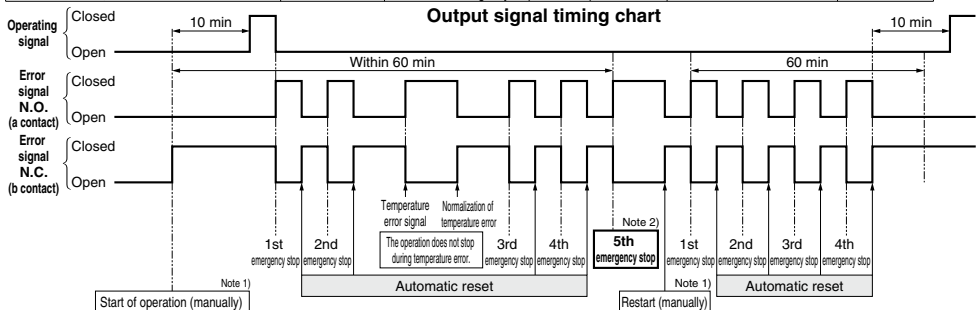

Note 1) The operation can be started or restarted (manually) by the operation stop switch mounted on the thermo-dryer or a remote switch prepared by the user.
 Note 2) When emergency stop is generated 5 times in an hour or the heater protection equipment (thermo-stat) is operated, the emergency stop status will be held. At this time, the dryer can be restarted by reset operation using the switch stated in Note 1.

Dimensions

IDH□4

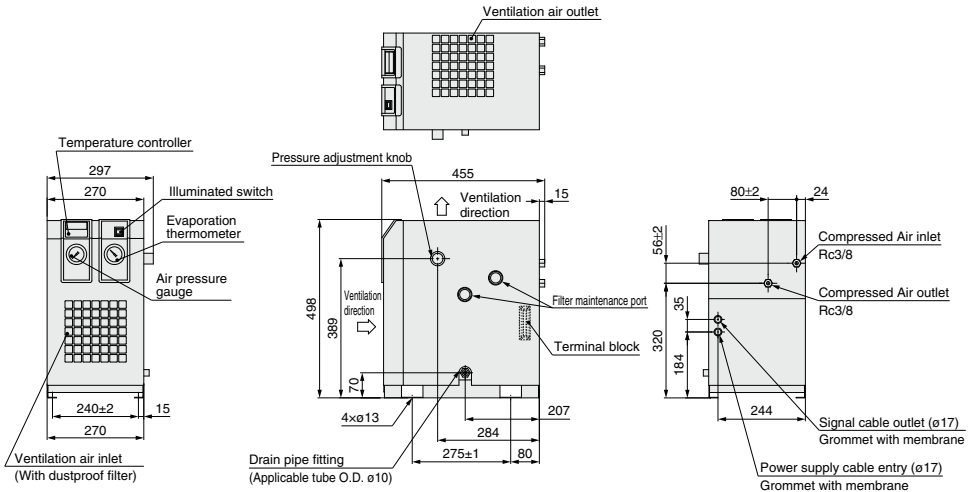

IDH□6

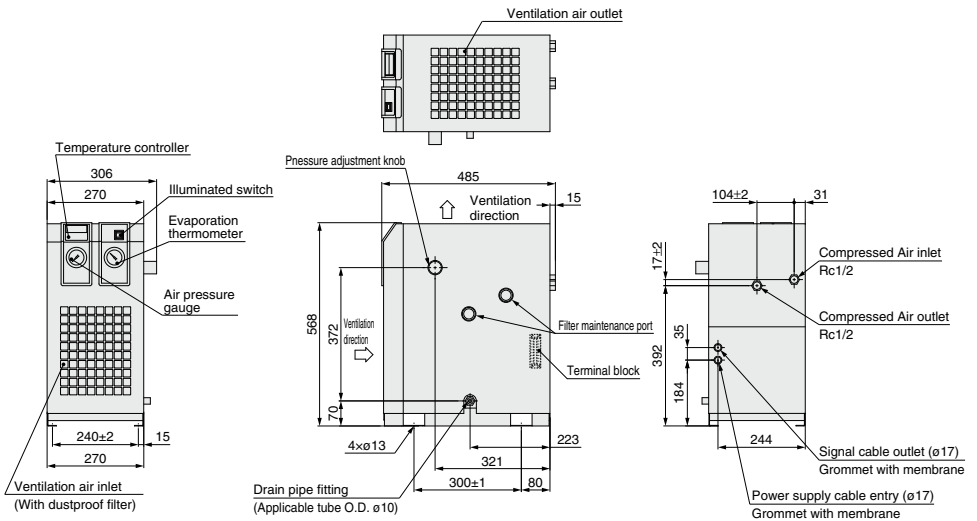

Condensed Water Calculation

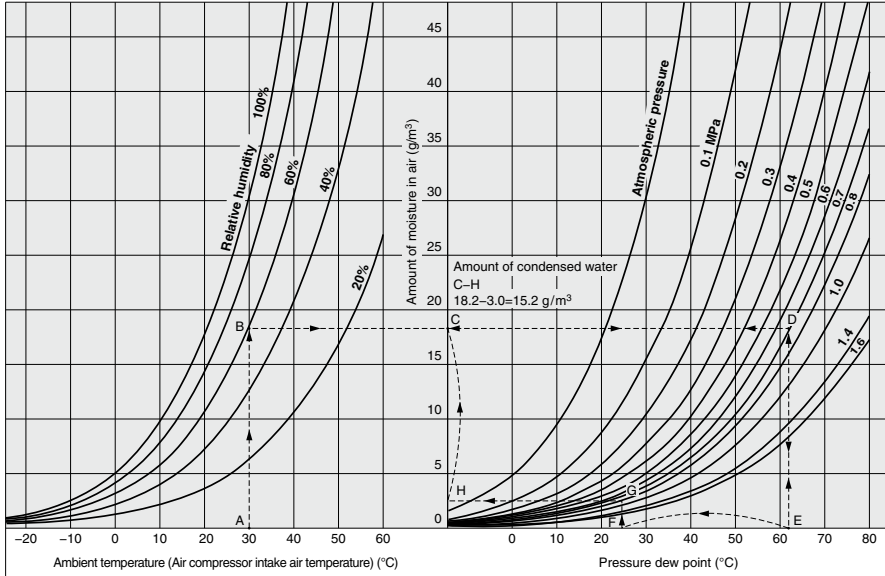

Dew Point Conversion Chart

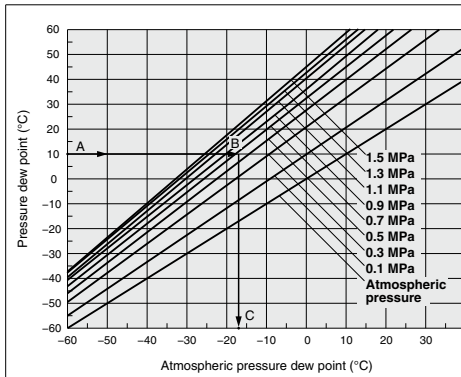

How to read the dew point conversion chart

Example) To obtain the atmospheric pressure dew point at a pressure dew point 10°C and a pressure 0.7 MPa.

- Trace the arrow mark → starting from the point A at a pressure dew point 10°C to obtain the intersection B on the pressure characteristic line for 0.7 MPa.
- Trace the arrow mark → starting from the point B to obtain the intersection C at the dew point under atmospheric pressure.
- The intersection C is the conversion value -17°C under atmospheric pressure dew point.

How to calculate the amount of condensed water

Example) To obtain the amount of condensed water when the pressure is applied to air up to 0.7 MPa with an air compressor, then cooled down to 25°C. Given an ambient temperature at 30°C and a relative humidity 60%.

- Trace the arrow mark from the point A at an ambient temperature 30°C to obtain the intersection B on the curved line for the relative humidity 60%.
- Trace the arrow mark from the intersection B to obtain the intersection D on the pressure characteristic line for 0.7 MPa.
- Trace the arrow mark from the intersection D to obtain the intersection E.
- The intersection E is the dew point under pressure 0.7 MPa with an ambient temperature 30°C and a relative humidity 60%. The value for E is 62°C.
- Trace the intersection E upward, and trace from the intersection D leftward to obtain the intersection C.
- The intersection C is the amount of moisture included in the compressed air 1 m³ at 0.7 MPa and a pressure dew point 62°C. **The amount of moisture is 18.2 g/m³.**
- Trace the arrow mark, starting from F for cooling temperature 25°C (pressure dew point 25°C) to obtain the intersection G on the pressure characteristic line for 0.7 MPa.
- From the intersection G, trace the arrow mark to obtain the intersection H on the vertical axis.
- The intersection H is the amount of moisture included in the compressed air 1 m³ at 0.7 MPa, and a pressure dew point 25°C. **The amount of moisture is 3.0 g/m³.**
- Therefore, the amount of condensed water is as follows (per 1 m³):

The amount of moisture at the intersection C
- the amount of moisture at the intersection H
= the amount of condensed water
18.2 - 3.0 = 15.2 g/m³



IDH □ Series

Specific Product Precautions 1

Be sure to read this before handling the products. Refer to page 9 for safety instructions and pages 10 to 12 for air preparation equipment precautions.

Design

⚠ Caution

1. Design a layout in which the dripping of condensation is taken into consideration.

Depending on the operating conditions, the product and its downstream pipes could drip water due to condensation formed by supercooling.

If this is a problem, install a drain receiver below this product or the condensation points and empty it regularly.

Alternatively, wind additional insulation around the condensation points.

2. Provide a design that prevents back pressure and back flow.

The generation of back pressure and back flow could lead to equipment damage. Take appropriate safety measures and proper installation procedures.

3. Refrain from operating at a flow rate below the minimum flow rate.

If a dryer is operated without compressed air flowing, there may be problems in detecting the correct temperature, and an abnormal stop or the disconnection of the heater may occur as a result.

4. Do not introduce an air flow that is greater than the maximum flow rate.

If the maximum flow rate is momentarily exceeded, it could lead to insufficient dehumidification, fluctuation in the controlled temperature, splashing of drainage and oil on the outlet side, and damage to the equipment.

5. When large quantities of dust (solid foreign matter) or water droplets are contained in the supply air, install an air filter on the upstream side of the thermo-dryer.

· When there are large quantities of dust (solid foreign matter), install a main line filter or mist separator.

· When large quantities of water droplets are contained, install a water separator.

6. Do not use the product with low pressure (blowers).

Each and every piece of air preparation equipment which is designed for use with compressed air, including thermo-dryers, has a minimum operating pressure. Use below the minimum operating pressure could lower performance or a malfunction. Contact SMC beforehand if use in such a situation is unavoidable.

7. Outlet air temperature attaining time

The refrigerant of the refrigerating circuit may not be cooled or the set air temperature may not be obtained by the effects of the heat capacity of the piping or filters, etc., immediately after the dryer operation or during intermittent operation (conditions, such as inlet air temperature, ambient temperature, flow rate, and pressure, etc.). When using the thermo-dryer, take an outlet air temperature attaining time of about 10 minutes into consideration after the dryer has been operated to flow the compressed air. Additionally, when the main circuit enters the intermittent operation, install a purge line and flow the compressed air continuously so as to use the thermo-dryer under conditions that the load applied to the dryer is constant. For details, refer to the Operation Manual.

Mounting

⚠ Warning

1. Ensure sufficient space for maintenance activities.

When installing the products, allow access for maintenance.

[Space required for maintenance]

Front: 600 mm Back: 600 mm

Top: 600 mm Right side: 600 mm Left side: 600 mm

⚠ Caution

1. Provide ventilation space.

Unless a necessary ventilation space for each piece of equipment is provided, this product could cool poorly or stall.

[Space required for installation]

Front: 600 mm Back: — mm

Top: 600 mm Right side: 600 mm Left side: — mm

*Allow sufficient space for piping on the back and left sides.

Installation

⚠ Caution

1. Avoid locations where the dryer will be in direct contact with wind or rain. (Avoid locations where relative humidity is 85% or more.)

2. Avoid exposure to direct sunlight.

3. Avoid locations that contain much dust, corrosive gases, or flammable gases.

4. Avoid locations of poor ventilation and high temperature.

5. Avoid locations where there is a strong magnetic noise (strong electric field, strong magnetic field, or surge).

6. Avoid locations or conditions where static electricity is discharged to the body.

7. Avoid locations where temperature rapidly changes.

8. Avoid locations where the dryer is likely to be damaged by lightning.

9. Avoid locations with an altitude of 2,000 m or higher. (Storage and transportation are not included.)

10. Avoid possible locations where the dryer could draw in high temperature air discharged from an air compressor or other dryer.

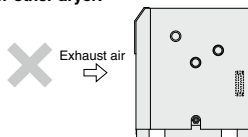

Confirm that the exhaust air does not flow into the neighboring equipment.

11. Avoid locations where strong impact or vibration is applied.

12. Avoid conditions where external force or weight that could deform the dryer is applied.

13. Avoid possible locations where the drain can freeze.

14. Avoid installation on machines for transporting, such as vehicles, ships, etc.

15. Avoid locations which experience sudden pressure/flow rate changes.



IDH □ *Series*

Specific Product Precautions 2

Be sure to read this before handling the products. Refer to page 9 for safety instructions and pages 10 to 12 for air preparation equipment precautions.

Air Piping

Caution

1. Be careful to avoid an error in connecting the air piping at the compressed air inlet (IN) and outlet (OUT).
2. Install a bypass piping since it is needed for maintenance.
3. When tightening piping at the air inlet/outlet tube, the hexagonal parts of the port on the product should be held firmly with a wrench or adjustable angle wrench.
4. The control temperature may fluctuate or condense due to the effect of ambient temperature. Be sure to wind heat resistant material around the outlet air piping.
5. Confirm that vibrations resulting from the compressor are not transmitted through the air piping to the product.
6. Do not allow the weight of the piping to lie directly on the product.
7. If a metallic flexible tubing is used for the inlet/outlet air piping, abnormal noise might be generated in the piping. In that case, please change it to the rigid tubing.

Wiring

Caution

1. **Verify the power supply voltage.**
Operating the equipment with a voltage that is out of specification could lead to a fire or an electrical shock. Verify the power supply and the voltage before wiring. The voltage fluctuation must be within the following specifications. Restarting: Rated voltage $\pm 10\%$ Operation: Rated voltage -5% to $+10\%$.
2. **Wire with appropriate size terminal.**
When connecting a power supply cord to equipment with a terminal box, use a terminal applicable to the terminal box. If an incorrect terminal size is used, it may cause a fire.
3. **Installing ground**
Provide a ground connection to prevent earth leakage. Do not connect the ground wire to a water pipe or a gas pipe due to a risk of explosion.
4. **Have the wiring done by a qualified professional.**
Only a qualified professional should carry out wiring work such as connecting to the terminal block.

Modification Prohibited

Caution

Do not disassemble or modify the product. Products which have been disassembled and/or modified cannot be guaranteed.