

Refrigerated Air Dryer

IDFB□E Series

For use in North, Central & South America

Protect Pneumatic Equipment from Moisture!



An air dryer removes the vapor from the moist compressed air delivered by the compressor, and prevents it from causing the pneumatic equipment to fail.

Effects of moisture on equipment

Malfunctioning of valves and actuators caused by dripping grease

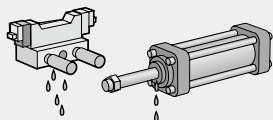

Decomposition of auto drain caused by rusting inside pipes

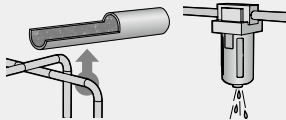

Generation of water droplets



Refrigerant

R134a(HFC), R407C(HFC)

Coefficient of destruction for ozone is zero.

Improved corrosion resistance with the use of stainless steel, plate type heat exchanger (IDFB4E to 75E)

UL certified product

Power supply voltage:

Single-phase
115 VAC (60 Hz)
230 VAC (60 Hz)
Three-phase
460 VAC (60 Hz)

Series	Rated inlet condition	Air flow capacity SCFM (m ³ /h [ANR])			Port size	Page
		Outlet air pressure dew point ^{Note}				
		37°F(2.8°C)	45°F(7.2°C)	50°F(10°C)		
IDFB3E	100°F (37.8°C) 100psi (0.7MPa)	10(17)	11(19)	12(20)	NPT3/8	p. 160 to 163
IDFB4E		15(25)	16(27)	17(28)	NPT1/2	
IDFB6E		25(43)	26(45)	28(47)	NPT3/4	
IDFB8E		41(70)	43(74)	45(77)		
IDFB11E		59(100)	62(106)	65(110)		
IDFB15E		71(120)	80(136)	86(147)	NPT1	p. 178 to 183
IDFB60		113(192)	155(264)	177(300)	R1 / NPT1	
IDFB70		166(282)	215(366)	251(426)	R1 1/2 / NPT1 1/2	
IDFB55E		226(384)	258(438)	297(504)	NPT2	
IDFB75E		300(510)	353(600)	406(690)		

(Note) Air flow capacity for each dew point is indicated.



1. Standard Products

IDFB Series

Standard inlet air type

Rated inlet air temperature:
100°F (37.8°C)



Model	Air flow capacity SCFM (m ³ /h [ANR])			Refrigerant	Rated inlet condition	Port size	Page
	Outlet air pressure dew point ^{Note}						
	37°F (2.8°C)	45°F (7.2°C)	50°F (10°C)				
IDFB3E	10 (17)	11 (19)	12 (20)	R134a (HFC)	100°F (37.8°C) 100 psi (0.7 MPa)	NPT 3/8	P. 160 to 163
IDFB4E	15 (25)	16 (27)	17 (28)			NPT 1/2	
IDFB6E	25 (43)	26 (45)	28 (47)			NPT 3/4	
IDFB8E	41 (70)	43 (74)	45 (77)			NPT 1	P. 178 to 183
IDFB11E	59 (100)	62 (106)	65 (110)			R1 / NPT 1	
IDFB15E	71 (120)	80 (136)	86 (147)	R410A (HFC)	R1 1/2 / NPT 1 1/2	P. 164 to 166	
IDFB60	113 (192)	155 (264)	177 (300)		NPT 2		
IDFB70	166 (282)	215 (366)	251 (426)	R407C (HFC)			
IDFB55E	226 (384)	258 (438)	297 (504)				
IDFB75E	300 (510)	353 (600)	406 (690)				

Note) Air flow capacity for each dew point is indicated.

2. Options

Optional specifications	Applicable model	Model (Suffix: Option symbol)	Page
Cool compressed air output	IDFB3E to 11E	IDFB□E-11-A	P. 167, 168
Moderate pressure specification (up to 240 psi (1.6 MPa)) (Auto drain bowl: Metal bowl with level gauge)	IDFB6E to 15E	IDFB□E-□-K	
With heavy duty auto drain (Applicable to moderate pressure)	IDFB55E, 75E	IDFB□E-46-L	
With circuit breaker	IDFB4E to 75E	IDFB□E-□-R	
Power supply terminal block connection (Voltage symbol 11 only)	IDFB3E to 15E	IDFB□E-11-S	
With terminal block for power supply, run & alarm signal and remote operation	IDFB4E to 75E	IDFB□E-□-T	
Timer type solenoid valve with auto drain (Applicable to moderate pressure)	IDFB4E to 75E	IDFB□E-□-V	

3. Accessory (Option)

Description	Page
Dust-protecting filter set	P. 169

IDFB□E Series

Model Selection

The corrected air flow capacity, which considers the user's operating conditions, is required for selecting the air dryer. Please select using the following procedures.

1 Read the correction factor.

Obtain the correction factor A to D suitable for your operating condition using the table below.

IDFB□E Selection Example

Condition		Data symbol	Correction factor ^{Note1)}
Inlet air temperature	110°F (43°C)	A	0.82
Ambient temperature	105°F (40.5°C)	B	0.98
Inlet air pressure	75 psi (0.53 MPa)	C	0.95
Air consumption	14 SCFM	—	—

Note) Values obtained from the table below.

2 Calculate the corrected air flow capacity.

Obtain the corrected air flow capacity from the following formula.
Corrected air flow capacity = Air consumption ÷ (Correction factor A x B x C)

$$\text{Corrected air flow capacity} = 14 \text{ SCFM} \div (0.82 \times 0.98 \times 0.95) = 18 \text{ SCFM}$$

3 Select the model.

Select the model which air flow capacity exceeds the corrected air flow capacity using the specification table. (For air flow capacity, refer to the data D below.)

According to the corrected air flow capacity of 18 SCFM, the **IDFB6E** will be selected because its air flow capacity at 60 Hz is 25 SCFM.

4 Option

Refer to pages 167, 168.

5 Finalize the model number.

Refer to pages 160, 164.

6 Select accessories sold separately.

Refer to page 169.

Data A: Inlet Air Temperature

Inlet air temperature		Correction factor	
°F	°C	IDFB3E to 15E	IDFB55E, 75E
90	32	1.31	1.08
100	37.8	1.00	1.00
110	43	0.82	0.83
122	50	0.66	0.46

Data B: Ambient Temperature

Ambient temperature		Correction factor
°F	°C	
77	25	1.24
90	32	1.09
95	35	1.04
100	37.8	1.00
104	40	0.98

Data C: Inlet Air Pressure

Inlet air pressure		Correction factor
psi	MPa	
75	0.53	0.95
100	0.70	1.00
110	0.76	1.04
120	0.83	1.07
125	0.86	1.09
150	1.03	1.13
175	1.21	1.18
200	1.38	1.22
232	1.60	1.24

Data D: Air Flow Capacity

Model	Air flow capacity SCFM (m³/h (ANR))								
	IDFB3E	IDFB4E	IDFB6E	IDFB8E	IDFB11E	IDFB15E	IDFB55E	IDFB75E	
Outlet air pressure dew point	37°F (2.8°C)	10 (17)	15 (25)	25 (43)	41 (70)	59 (100)	71 (120)	226 (384)	300 (510)
	45°F (7.2°C)	11 (19)	16 (27)	26 (45)	43 (74)	62 (106)	80 (136)	258 (438)	353 (600)
	50°F (10°C)	12 (20)	17 (28)	28 (47)	45 (77)	65 (110)	86 (147)	297 (504)	406 (690)

Note1) In case of "Option A (Cool compressed air output)", the air flow capacity is different. Refer to page 167 for details. (IDFB3E to 11E)

Note2) The outlet air pressure dew point varies depending on the operating conditions.

Particularly when the outlet air pressure dew point is 37°F or 45°F, though this depends on the operating conditions, freeze protection functions may be activated, resulting in the dew point rising and becoming unstable.

If a stable low dew point is required, consider an IDG series membrane air dryer.

Refrigerant R134a (HFC)

Standard Inlet Air

IDFB□E Series

3E, 4E, 6E, 8E, 11E, 15E

(Max. inlet air temperature: 122°F [50°C], Max. ambient temperature: 104°F [40°C])



How to Order

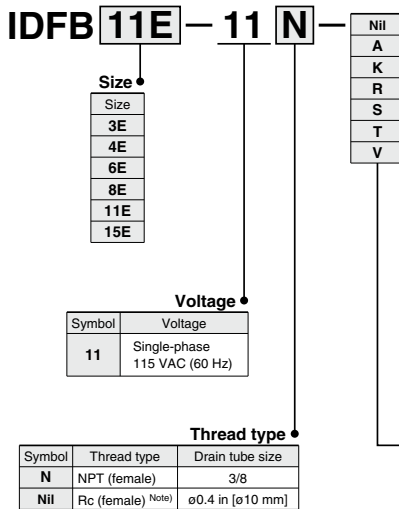

Note) An adapter for converting NPT to Rc is included if the thread symbol is "Nil".

Table of Options and Available Combinations (Size/Option)

Symbol ^{Note 1)}	Nil	A	K	R	S	T	V
Optional specifications ^{Note 4)}	None	Cool compressed air output	Moderate pressure specification ^{Note 2)} (Auto drain bowl; Metal case with level gauge)	With circuit breaker	Power supply terminal block connection ^{Note 3)}	With terminal block for run & alarm signal	Timer type solenoid valve with auto drain (Applicable to moderate pressure ^{Note 2)})
Size							
3	●	●	—	—	●	—	—
4	●	●	—	●	●	●	●
6	●	●	●	●	●	●	●
8	●	●	●	●	●	●	●
11	●	●	●	●	●	●	●
15	●	—	●	●	●	●	●

Note 1) Enter alphabetically when multiple options are combined. However, the following combination cannot be achieved.

- Combination of S and T (Because S function is also included in T.)
- Combination of K and V (Only one or the other may be attached.)

Note 2) The maximum operating pressure is 240 psi (1.6 MPa).

Note 3) Standard specification is the power cable with plug.

Note 4) Refer to pages 167 and 168 for further information on options.

Standard Specifications

Model		Standard inlet air					
Specifications		IDFB3E	IDFB4E	IDFB6E	IDFB8E	IDFB11E	IDFB15E
Operating conditions ^{Note 3}	Fluid	Compressed air					
	Inlet air temperature °F (°C)	41 to 122 (5 to 50)					
	Inlet air pressure psi (MPa)	22 (0.15) to 150 (1.0) ^{Note 8)}					
	Ambient temperature °F (°C)	36 to 104 (2 to 40) Relative humidity of 85% or less					
Rated conditions ^{Note 4)}	Air flow capacity SCFM ^{Note 1)}	10 (17)	15 (25)	25 (43)	41 (70)	59 (100)	71 (120)
	Outlet air pressure dew point 37°F (2.8°C)						
	Outlet air pressure dew point 45°F (7.2°C)	11 (19)	16 (27)	26 (45)	43 (74)	62 (106)	80 (136)
	Outlet air pressure dew point 50°F (10°C)	12 (20)	17 (28)	28 (47)	45 (77)	65 (110)	86 (147)
Electrical characteristics	Operating pressure psi (MPa)	100 (0.7)					
	Inlet air temperature °F (°C)	100 (37.8)					
	Ambient temperature °F (°C)	100 (37.8)					
	Power supply voltage (frequency)	Single-phase 115 VAC [voltage fluctuation ±10%] 60 Hz					
	Operating current ^{Note 5)} (A)	2.7	3.0	3.0	3.5	6.5	8.5
	Power consumption ^{Note 5)} (W)	240	260	260	310	550	800
	Applicable circuit breaker capacity ^{Note 6)} (sensitivity current 30 mA) (A)	15					
Condenser		Forced air-cooled					
Refrigerant		R134a (HFC)					
Refrigerant charge oz (g)		6.3 (180)	7.0 (200)	8.1 (230)	9.5 (270)	10.2 (290)	12.0 (340)
Thread symbol and size	Symbol N	NPT 3/8 (female)	NPT 1/2 (female)	NPT 3/4 (female)		NPT 1 (female)	
	Symbol Nil	Rc 3/8 (female) With Rc conversion adapter	Rc 1/2 (female) With Rc conversion adapter	Rc 3/4 (female) With Rc conversion adapter		Rc 1 (female) With Rc conversion adapter	
Drain tube O.D.	Symbol N	3/8 inch					
	Symbol Nil	10 mm					
Weight lbs (kg)		40 (18)	55 (25)	57 (26)	64 (29)	73 (33)	110 (50)
Compliant standards		UL, CSA					

Note 1) ANR is under the conditions of 68°F (20°C) at atmospheric pressure and relative humidity of 65%.

Note 2) Air flow capacity for each outlet air pressure dew point is indicated.

Note 3) The operation range does not guarantee the use with normal air flow capacity.

Note 4) When operating conditions are different from the rated specifications, please select a model in accordance with the Model Selection (Page 159).

Note 5) These values are reference values under rated conditions, and are not guaranteed. Do not use these values for the thermal set values, etc.

Note 6) Product other than the option R is not equipped with an earth leakage breaker. Please purchase an appropriate earth leakage breaker separately.

Note 7) If this equipment suffers a short-term power outage (even if it is only momentary), it may require some time before normal operation resumes, and protective mechanisms may prevent normal operation even after the power supply has been restored.

Note 8) The maximum operating pressure is 240 psi (1.6 MPa) as standard, but it is possible to achieve 1.6 MPa when selecting Option K or Option V.

Replacement Parts

Model		IDFB3E	IDFB4E	IDFB6E	IDFB8E	IDFB11E	IDFB15E
Auto drain replacement part no. ^{Note 9)}	Thread symbol N	AD38N-Z-A			AD48N-Z-A		
	Thread symbol Nil	AD38-A			AD48-A		
	Thread symbol N	AD38N-Z			AD48N-Z		
	Thread symbol Nil	AD38			AD48		

Note 9) The part number for the auto drain (Bowl assembly) components without including the body part. Body part replacement is impossible.

In addition, a new line of auto drain models was recently introduced in March 2019.

The previous models and the new models do not have mounting interchangeability. For details, refer to page 170.

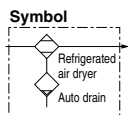
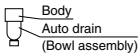

Construction Principle (Circuit for Air/Refrigerant)

Humid, hot air coming into the air dryer will be cooled down by a cooler (heat exchanger). Water condensed as this time will be removed from the air by a drain separator (auto drain) and drained out automatically. Air separated from the water will be heated by a re-heater (heat exchanger) to obtain the dried air, which goes through to the outlet side.

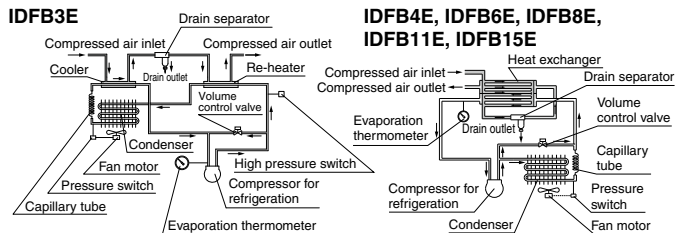

Dimensions

IDFB3E

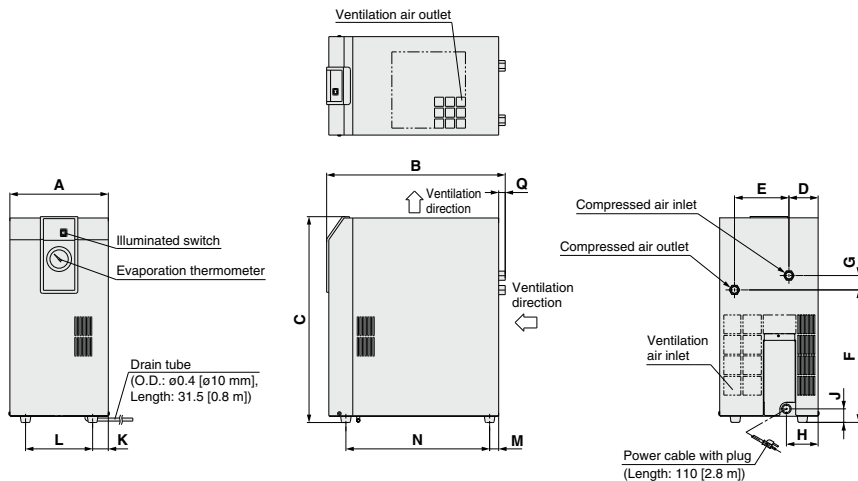

Dimensions

Model	Port size	A	B	C	D	E	F	G	H	J	K	L	M	N	Q	Unit: inch [mm]
IDFB3E	3/8	8.9 [226]	16.1 [410]	18.6 [473]	2.6 [67]	4.9 [125]	12.0 [304]	1.3 [33]	2.9 [73]	1.2 [31]	1.4 [36]	6.1 [154]	0.8 [21]	13.0 [330]	0.6 [15]	

IDFB4E to IDFB11E

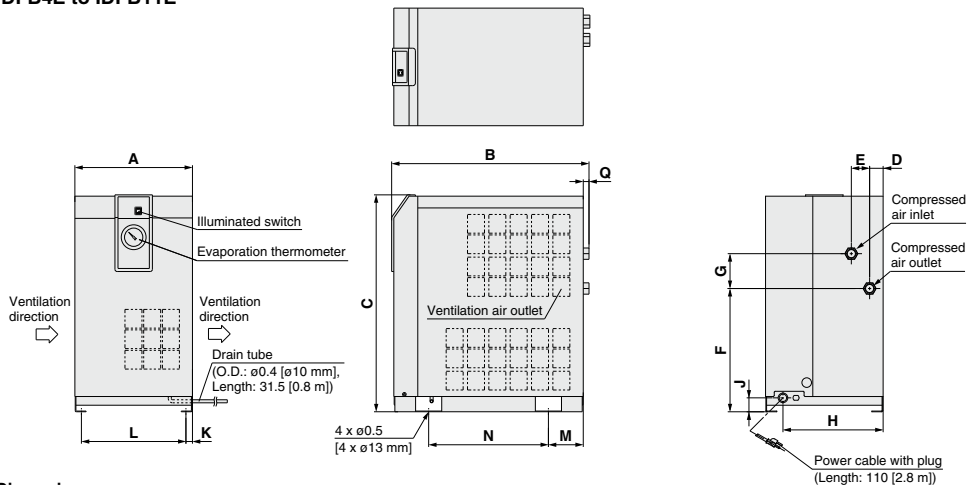

Dimensions

Model	Port size	A	B	C	D	E	F	G	H	J	K	L	M	N	Q	Unit: inch [mm]
IDFB4E	1/2	17.8 [453]	19.6 [498]	1.2 [31]	1.7 [42]	11.1 [283]	3.1 [80]	9.1 [230]	1.3 [32]	0.6 [15]	9.4 [240]	3.1 [80]	10.8 [275]	0.5 [13]		
IDFB6E		10.6 [270]	17.9 [455]													
IDFB8E	3/4	19.1 [485]	22.4 [568]	14 [355]												
IDFB11E		11.8 [300]														

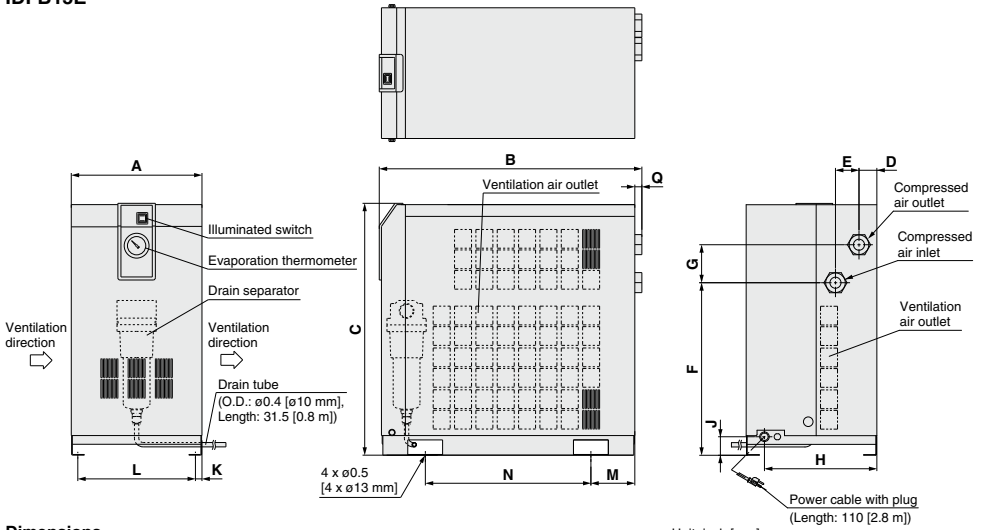
Dimensions
IDFB15E

Dimensions

Unit: inch [mm]

Model	Port size	A	B	C	D	E	F	G	H	J	K	L	M	N	Q
IDFB15E	1	11.8 [300]	23.7 [603]	22.8 [578]	1.6 [41]	2.1 [54]	16.6 [396]	3.4 [87]	10.2 [258]	1.7 [43]	0.6 [15]	10.6 [270]	4.0 [101]	15.0 [380]	0.6 [16]

Refrigerant R407C (HFC) Standard Inlet Air

IDFB□E Series

55E, 75E

(Max. inlet air temperature: 122°F [50°C], Max. ambient temperature: 104°F [40°C])

The IDFB22E/37E has been discontinued.



How to Order

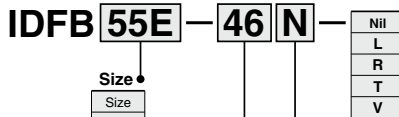

Table of Options and Available Combinations (Size/Option) ●

Symbol <small>Note 1)</small>	Nil	L	R	T	V
Optional specifications <small>Note 3)</small>	None	With heavy duty auto drain (Applicable to moderate pressure <small>Note 2)</small>	With circuit breaker	With terminal block for run & alarm signal	Timer type solenoid valve with auto drain (Applicable to moderate pressure <small>Note 2)</small>
Size	●	●	●	●	●
55	●	●	●	●	●
75	●	●	●	●	●

Note 1) Enter alphabetically when multiple options are combined.

However, the following combination cannot be achieved.

● Combination of L and V (All of them are auto drain and only one or the other may be attached.)

Note 2) The maximum operating pressure is 240 psi (1.6 MPa).

Note 3) Refer to pages 167 and 168 for further information on options.

Standard Specifications

Specifications		Model	
		IDFB55E	IDFB75E
Operating conditions (Note 3)	Fluid	Compressed air	
	Inlet air temperature °F (°C)	41 to 122 (5 to 50)	
	Inlet air pressure psi (MPa)	22 (0.15) to 150 (1.0) (Note 8)	
	Ambient temperature °F (°C)	36 to 104 (2 to 40) Relative humidity of 85% or less	
Rated conditions (Note 4)	Air flow capacity SCFM (Note 1)	226 (384)	300 (510)
	Outlet air pressure dew point 37°F (2.8°C)		
	Outlet air pressure dew point 45°F (7.2°C)	258 (438)	353 (600)
	Outlet air pressure dew point 50°F (10°C)	297 (504)	406 (690)
Electrical characteristics	Operating pressure psi (MPa)	100 (0.7)	
	Inlet air temperature °F (°C)	100 (37.8)	
	Ambient temperature °F (°C)	100 (37.8)	
Condenser	Power supply voltage (frequency)	Three-phase 460 VAC [voltage fluctuation ±10%] 60 Hz	
	Operating current (Note 5) (A)	3.8	
	Power consumption (Note 5) (W)	2400	
	Applicable circuit breaker capacity (Note 6) (sensitivity current 30 mA) (A)	10	
Refrigerant		R407C (HFC)	
Refrigerant charge	oz (g)	15.2 (430)	20.8 (590)
Thread symbol and size	Symbol N	NPT 2 (male)	
	Symbol Nil	R 2 (male)	
Drain tube O.D.	Symbol N	3/8 inch	
	Symbol Nil	10 mm	
Weight	lbs (kg)	258 (117)	271 (123)
Compliant standards		UL, CSA	

Note 1) ANR is under the conditions of 68°F (20°C) at atmospheric pressure and relative humidity of 65%.

Note 2) Air flow capacity for each outlet air pressure dew point is indicated.

Note 3) The operation range does not guarantee the use with normal air flow capacity.

Note 4) When operating conditions are different from the rated specifications, please select a model in accordance with the Model Selection (Page 159).

Note 5) These values are reference values under rated conditions, and are not guaranteed. Do not use these values for the thermal set values, etc.

Note 6) Product other than the option R is not equipped with an earth leakage breaker. Please purchase an appropriate earth leakage breaker separately.

Note 7) If this equipment suffers a short-term power outage (even if it is only momentary), it may require some time before normal operation resumes, and protective mechanisms may prevent normal operation even after the power supply has been restored.

Note 8) The maximum operating pressure is 240 psi (1.6 MPa) as standard, but it is possible to achieve 1.6 MPa when selecting Option K or Option V.

Replacement Parts

Model		IDFB55E	IDFB75E
Auto drain replacement part no. (Note 8)	Thread symbol N	AD48N-Z-A	
	Thread symbol Nil	AD48-A	
	Thread symbol N	AD48N-Z	
	Thread symbol Nil	AD48	

Note 8) The part number for the auto drain (Bowl assembly) components without including the body part. Body part replacement is impossible.

In addition, a new line of auto drain models was recently introduced in either March or June 2019. The previous models and the new models do not have mounting interchangeability. For details, refer to page 170.

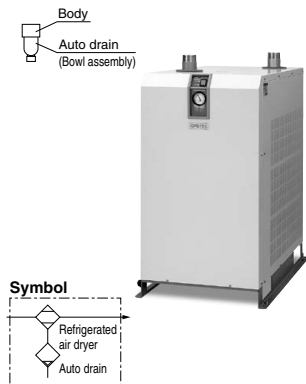

Construction Principle (Circuit for Air/Refrigerant)

Humid, hot air coming into the air dryer will be cooled down by a cooler re-heater (heat exchanger). Water condensed at this time will be removed from the air by a drain separator (auto drain) and drained out automatically. Air separated from the water will be heated by a cooler re-heater (heat exchanger) to obtain the dried air, which goes through to the outlet side.

IDFB55E, IDFB75E

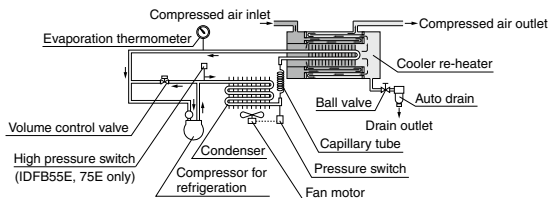

Dimensions

IDFB55E, IDFB75E

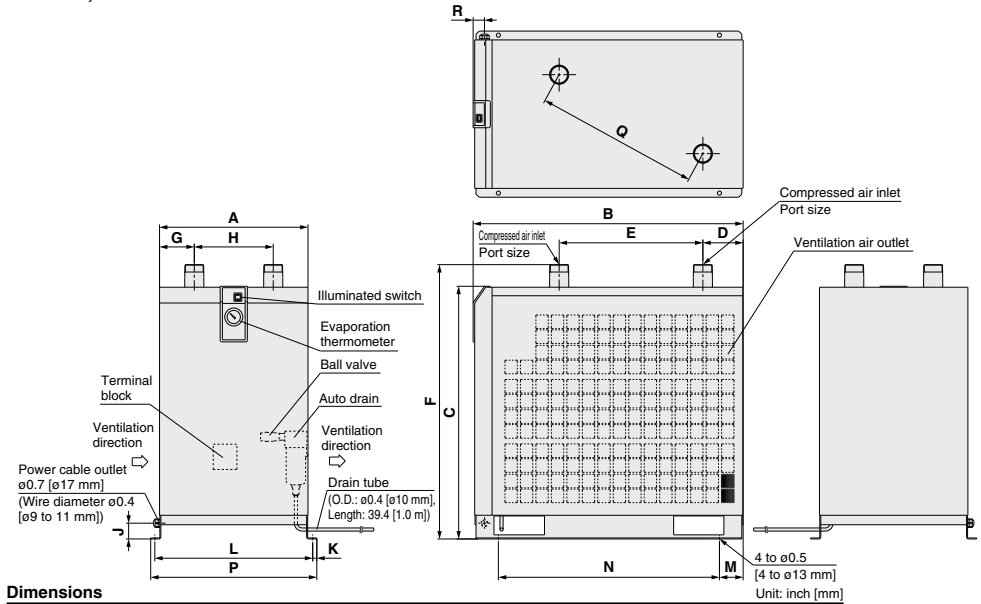

Dimensions

Model	Port size	A	B	C	D	E	F	G	H	J	K	L	M	N	P	Q	R
IDFB55E	2	18.5	33.7	31.5	5.0	17.9	34.2	4.3	9.8	2	0.5	19.7	3.0	27.6	20.7	20.4	1.4
		[470]	[855]	[800]	[128]	[455]	[868]	[110]	[250]	[50]	[13]	[500]	[75]	[700]	[526]	[519]	[36]
IDFB75E	2			35.4			38.1										
				[900]			[968]										

Unit: inch [mm]

Optional Specifications 1

Refer to “How to Order” on pages 160 and 164 for optional models.

A Option symbol

Cool compressed air output IDFB3E to 11E

There is no heating of cooled, dehumidified air as it leaves the air dryer. The air flow capacity with this option is smaller than that of the standard dryer. (The external dimensions are identical with the standard product.)
 (Note) Perform thermal insulation treatment for pipings and equipment installed after the dryer to prevent the formation of condensation.

Air Flow Capacity

Model	IDFB3E	IDFB4E	IDFB6E	IDFB8E	IDFB11E
Air flow capacity (ANR)	5 SCFM (8 m ³ /h)	13 SCFM (23 m ³ /h)	17 SCFM (29 m ³ /h)	19 SCFM (32 m ³ /h)	23 SCFM (39 m ³ /h)

Conditions: Inlet air pressure: 100 psi (0.7 MPa), Inlet air temperature: 100°F (37.8°C),
 Outlet air temperature: 50°F (10°C), Ambient temperature: 100°F (37.8°C)

K Option symbol

Moderate pressure specification (Auto drain bowl: Metal bowl with level gauge) IDFB6E to 15E

The auto drain is changed from the standard one to one with a moderate pressure specification.
 A metal bowl with a level gauge which can confirm the water level is used for the auto drain.

Specifications

1. Maximum operating pressure: 240 psi (1.6 MPa)
2. Dimensions ... same as standard products

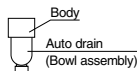

Replacement Parts

Model	Auto drain assembly part no. (Note)	Note
IDFB6E to 15E-11N	IDF-S1927	The AD48N-8Z-A-X2112 auto drain (bowl assembly) excluding the body, insulator, and One-touch fitting are included.
IDFB6E to 15E-11	IDF-S1926	The AD48-8-A-X2112 auto drain (bowl assembly) excluding the body, insulator, and One-touch fitting are included.

(Note) A new line of auto drain models was released in March 2019. The previous models and the new models do not have mounting interchangeability. Refer to page 170 for details.

L Option symbol

With heavy duty auto drain (Applicable to moderate pressure) IDFB55E, 75E

More thorough drain discharge can be achieved by replacing the float type auto drain (used with standard equipment) with a heavy duty auto drain (ADH4000-04).

(The external dimensions are identical with the standard product.)

Maximum operating pressure: 240 psi (1.6 MPa)

Replacement Parts

Model	Replacement part no. (Description)	Configuration
IDFB55E, 75E	ADH-E400 (Exhaust mechanism replacement kit)	Exhaust mechanism replacement kit Housing (a mounted unit is used)

R Option symbol

With circuit breaker IDFB4E to 75E

A circuit breaker with cover is attached to the side of the air dryer. This saves additional electrical wiring at the time of installation.

IDFB4E to 15E

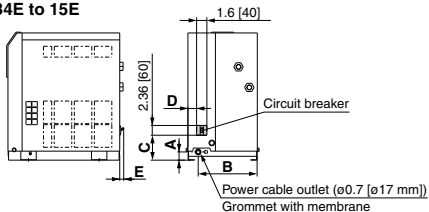

Dimensions

Model	A	B	C	D	E	Unit: inch [mm]
IDFB4E, 6E, 8E, 11E	1.3 [32]	9.0 [230]	3.8 [97]	1.3 [34]	0.6 [15]	
IDFB15E	1.7 [43]	10.2 [258]	4.0 [102]	3.2 [82]	—	

IDFB55E/75E

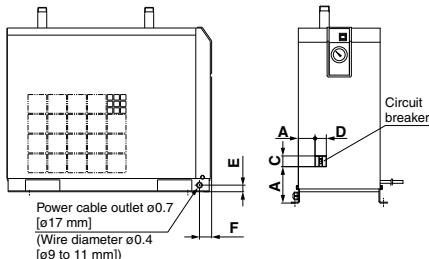

Dimensions

Model	A	B	C	D	E	F	Unit: inch [mm]
IDFB55E, 75E	5.7 [145]	2.2 [56]	3.8 [96]	2.4 [60]	2 [50]	1.4 [36]	

Breaker Capacity and Sensitivity Current

Model	Breaker capacity	Sensitivity current
IDFB4E to 15E	10 A	30 mA
IDFB55E, 75E	10 A	30 mA

Optional Specifications 2

Refer to “How to Order” on pages 160 and 164 for optional models.

S Option symbol

Power supply terminal block connection

IDFB3E-11 to 15E-11

The option allows the connection of a power cable to a terminal block. 460 V specification is equipped as standard.

IDFB3E_Terminal block

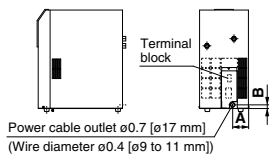

IDFB4E to 11E_Terminal block

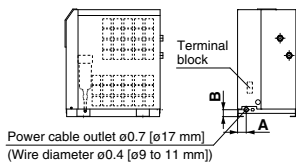

IDFB15E_Terminal block

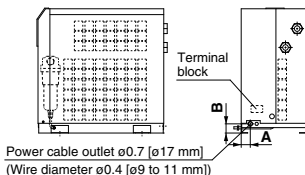

T Option symbol

With terminal block for power supply, run & alarm signal and remote operation

IDFB4E to 75E

In addition to the terminals for the power supply, terminals for the operating signal and the error signal are also available. (No-voltage contact) Also, in case of remote control, operate it from the power supply side while the air dryer switch remains ON.

Contact capacity: 230 VAC, 4 A, 24 VDC, 5 A for operating and error signals. Minimum current value: 20 V, 5 mA (AC/DC) for operating and error signals.

Note) Please be sure to confirm the electric circuits with the drawings or instruction manual before using the output signal.

IDFB4E to 15E

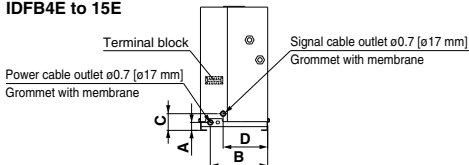

Dimensions

Model	Unit: inch [mm]			
	A	B	C	D
IDFB4E, 6E, 8E, 11E	1.3 [32]	9.0 [230]	2.6 [67]	7.0 [179]
IDFB15E	1.7 [43]	10.2 [258]	3.0 [77]	6.2 [158]

IDFB55E/75E

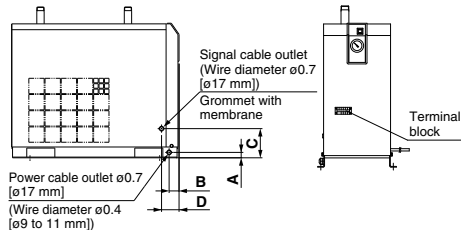

Dimensions

Model	Unit: inch [mm]			
	A	B	C	D
IDFB55E, 75E	2 [50]	1.4 [36]	10.6 [270]	3.2 [81]

V Option symbol

Timer type solenoid valve with auto drain (Applicable to moderate pressure)

IDFB4E to 75E

Drainage is discharged by controlling a solenoid valve with a timer. A strainer for solenoid valve protection and stop valve are also included. (The external dimensions are identical with the standard product.)

Maximum operating pressure: 240 psi (1.6 MPa)

* The timer type solenoid valve actuates once (for 0.5 seconds) every 30 seconds.

Replacement Parts

Model	Part no.	Note
IDFB4E to 15E-11□	IDF-S0199	115 VAC
IDFB55E, 75E-46□	IDF-S0302	230 VAC

IDFB□E Series Accessory (Option)

	Features	Specifications	Applicable dryer
Dust-protecting filter set 	Prevents a decline in the performance of the air dryer, even in a dusty atmosphere.	Max. ambient temperature 104°F (40°C)	IDFB3E to 75E

How to Order

Dust-protecting filter set

IDF — FL 209

Applicable dryer

Symbol	Applicable dryer
209	IDFB3E
203	IDFB4E IDFB6E
204	IDFB8E
205	IDFB11E
206	IDFB15E
213	IDFB55E
214	IDFB75E

Dust-protecting Filter Set/Dimensions

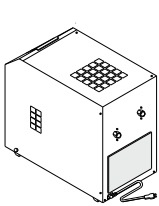

(IDF-FL209)

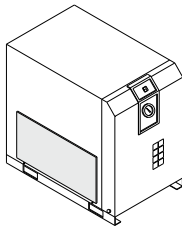

(IDF-FL203 to 208, 213, 214)

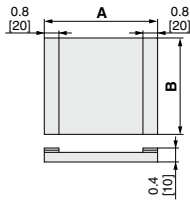

Dimensions

Unit: inch [mm]

Part no.	Applicable dryer	A	B	Weight lb [g]
IDF-FL209	IDFB3E	8.7 [220]	9.4 [240]	0.08 [35]
	IDFB4E IDFB6E	14.8 [375]	7.7 [195]	0.12 [55]
IDF-FL204	IDFB8E	13.3 [340]	10.4 [265]	0.15 [70]
IDF-FL205	IDFB11E	14.8 [375]		0.17 [75]
IDF-FL206	IDFB15E	[17.3] 440	[14.5] 370	[0.26] 120
IDF-FL213	IDFB55E	28.3 [720]	15.7 [400]	0.39 [175]
IDF-FL214	IDFB75E	24 [610]	22 [560]	0.42 [190]

IDFB□E Series

Auto Drain Replacement Parts: Previous and New Model Product Nos.

A new line of auto drain models, which feature new product numbers and a new shape, was recently introduced, with manufacturing starting in either March or June 2019 (depending on the model). The previous auto drain models and the new auto drain models do not have mounting interchangeability. Please check the serial number on the dryer specification label before ordering.

Auto drain (Bowl assembly)

Previous model



Metal bowl guard

New model



Transparent bowl guard
(Polycarbonate)

Thread type: NPT

Dryer model	Auto drain (Bowl assembly) part no.	Manufacturing date	SERIAL No.
IDFB3E/4E-11N	Previous AD38N-Z	Manufactured in February 2019 and before	XP and before
	New AD38N-Z-A	Manufactured in March 2019 and after	XQ and after
IDFB6E/8E/11E/ 15E/22E/37E-□N	Previous AD48N-Z	Manufactured in February 2019 and before	XP and before
	New AD48N-Z-A	Manufactured in March 2019 and after	XQ and after
IDFB55E/75E-□N	Previous AD48N-Z	Manufactured in May 2019 and before	XS and before
	New AD48N-Z-A	Manufactured in June 2019 and after	XT and after

Thread type: RC, R

Dryer model	Auto drain (Bowl assembly) part no.	Manufacturing date	SERIAL No.
IDFB3E/4E-11	Previous AD38	Manufactured in February 2019 and before	XP and before
	New AD38-A	Manufactured in March 2019 and after	XQ and after
IDFB6E/8E/11E/ 15E/22E/37E-□	Previous AD48	Manufactured in February 2019 and before	XP and before
	New AD48-A	Manufactured in March 2019 and after	XQ and after
IDFB55E/75E-□	Previous AD48	Manufactured in May 2019 and before	XS and before
	New AD48-A	Manufactured in June 2019 and after	XT and after

Option: K Moderate pressure specification (Auto drain bowl type: Metal bowl with level gauge)

Previous



New



Thread type: NPT

Dryer model	Auto drain (Bowl assembly) part no.	Manufacturing date	SERIAL No.
IDFB6E/8E/11E/ 15E-11N-K	Previous IDF-S0201 ^{*1}	Manufactured in February 2019 and before	XP and before
	New IDF-S1927 ^{*2}	Manufactured in March 2019 and after	XQ and after

*1 Assembly of auto drain: AD48N-8Z-X2110, One-touch fitting: KQ2H11-35AS, and insulator

*2 Assembly of auto drain: AD48N-8Z-A-X2112, One-touch fitting: KQ2H11-35AS, and insulator

IDFB22E/37E-□N-K	Previous AD48N-8Z-X2110 ^{*3}	Manufactured in February 2019 and before	XP and before
	New AD48N-8Z-A-X2112 ^{*3}	Manufactured in March 2019 and after	XQ and after

*3 One-touch fitting: KQ2H11-35AS is not included.

Thread type: Rc, R

Dryer model	Auto drain (Bowl assembly) part no.	Manufacturing date	SERIAL No.
IDFB6E/8E/11E/ 15E-11-K	Previous IDF-S0086 ^{*1}	Manufactured in February 2019 and before	XP and before
	New IDF-S1926 ^{*2}	Manufactured in March 2019 and after	XQ and after

*1 Assembly of auto drain: AD48-8-A-X2110, One-touch fitting: KQ2H10-02AS, and insulator

*2 Assembly of auto drain: AD48-8-A-X2112, One-touch fitting: KQ2H10-02AS, and insulator

IDFB22E/37E-□K	Previous AD48-8-X2110 ^{*3}	Manufactured in February 2019 and before	XP and before
	New AD48-8-A-X2112 ^{*3}	Manufactured in March 2019 and after	XQ and after

*3 One-touch fitting: KQ2H10-02AS.

Manufacturing date Serial number confirmation method

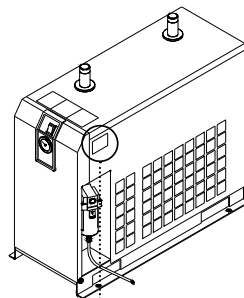

Specification Label

SERIAL No.: **X Q**

Manufacturing
year

Symbol	Year
A	1996
B	1997
:	:
W	2018
X	2019
Y	2020
:	:

Manufacturing
month

Symbol	Month
o	1
P	2
Q	3
R	4
S	5
T	6
U	7
V	8
W	9
X	10
y	11
Z	12



IDFB□E Series

Specific Product Precautions 1

Be sure to read this before handling the products.

Refer to page 9 for safety instructions and pages 10 to 12 for air preparation equipment precautions.

Installation

⚠ Caution

- Avoid locations where the air dryer will be in direct contact with wind and rain. (Avoid locations where relative humidity is greater than 85%.)
- Avoid exposure to direct sunlight.
- Avoid locations that contain much dust, corrosive gases, or flammable gases. Failure due to corrosion is not covered under warranty.
- Avoid locations of poor ventilation and high temperature.
- Allow ample space around the air dryer.
- Avoid locations where a dryer could draw in high temperature air that is discharged from an air compressor or other dryer.
- Avoid locations subjected to vibration.
- Avoid possible locations where the drain can freeze.
- Use the air dryer with an ambient temperature lower than 104°F (40°C).
- Avoid installation on machines for transporting, such as trucks, ships, etc.
- Avoid locations which experience sudden pressure/flow rate changes.
- When installing in locations where the dripping of condensation is a problem

Depending on the operating conditions, the product and its downstream pipes could drip water due to condensation formed by supercooling.

If this is a problem, install a drain receiver below this product or the condensation points and empty it regularly.

Alternatively, wind additional insulation around the condensation points.

Drain Tube

⚠ Caution

- A polyurethane tube is attached as a drain tube for the IDFB3E to 75E. Use this tube to discharge drainage.
 - Do not use the drain tube in an upward direction. Do not bend or crush the drain tube. (The auto drain will not be activated and water will try to escape via the air outlet.)
- If it is necessary that the tube goes upwards, make sure it only goes as far as the position of the auto drain.
- The drain tube comes with a tube fitting. Pipe a 10 mm O.D. tube with a length of 5 m or less.

Power Supply

⚠ Caution

- Connect the power supply to the terminal block.
- Install a suitable circuit breaker applicable for the specific model.
- The voltage fluctuation should be maintained within $\pm 10\%$ of the rated voltage.

Note) Select a circuit breaker with a sensitivity current 30 mA. As regards rated current, refer to "Applicable circuit breaker capacity" on pages 161 and 165.

Air Piping

⚠ Caution

- Be careful to avoid an error in connecting the air piping at the compressed air inlet (IN) and outlet (OUT).
- Install by-pass piping since it is needed for maintenance.

IDFB3E

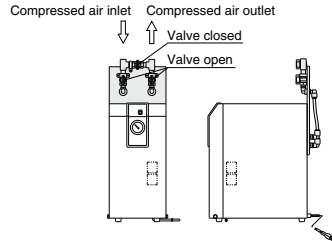

IDFB4E to 15E

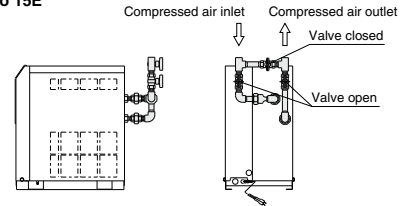

IDFB55E, 75E

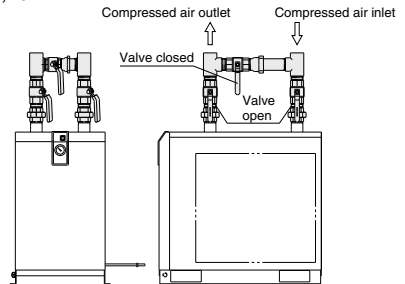

- When tightening piping at the air inlet/outlet tube, the hexagonal parts of the port on the air dryer side or piping should be held firmly with a spanner or adjustable angle wrench.
- Variations in operating conditions may cause condensation to form at the surface of the outlet piping. Apply thermal insulation around the piping to prevent condensation from forming.
- Vibration resulting from the compressor should not be transmitted through air piping to the air dryer.
- Do not allow the weight of the piping to lie directly on the air dryer.
- If a metallic flexible tubing is used for the inlet/outlet air piping abnormal noise might be generated in the piping. In that case, please change it to the rigid tubing.



IDFB□E Series

Specific Product Precautions 2

Be sure to read this before handling the products.

Refer to page 9 for safety instructions and pages 10 to 12 for air preparation equipment precautions.

Protection Circuit

Caution

When the air dryer is operated under the following stated conditions, a protection circuit is activated, the light turns off and operation stops.

- When the compressed air temperature is too high.
- When the compressed air flow rate is too high.
- When the ambient temperature is too high. (104°F (40°C) or higher)
- When the fluctuation of the power supply is beyond the rated voltage $\pm 10\%$.
- When the dryer is drawing in high temperature air that is discharged from an air compressor or other dryer.
- The ventilation port is obstructed by a wall or clogged with dust.

Compressor Air Delivery

Caution

Use the air compressor with an air delivery of 3.5 SCFM (6 m³/h) or larger for the IDFB3E to 75E series.

Since the auto drain of the IDFB3E to 75E series is designed in such a way that the valve remains open unless the air pressure rises to 22 psi (0.15 MPa) or higher, air will blow out from the drain discharge port when the air compressor starts up until the pressure increases. Therefore, if the air compressor has a small air delivery, the pressure may not be sufficient.

Auto Drain

Caution

The auto drain may not function properly, depending on the quality of the compressed air. Check the operation once a day.

Cleaning of Ventilation Area

Caution

Remove dust from the ventilation area once a month using a vacuum cleaner or an air blow nozzle.

Delay for Restarting

Caution

- Allow at least three minutes before restarting the dryer. If the air dryer is restarted within three minutes after being stopped, the protection circuit will be activated, operating light will turn off and the dryer will not be activated.
- The residual drainage in the air dryer may splash over the outlet when the operation is re-started, so it is recommended to install a filter on the outlet of the air dryer.

Modifying the Standard Specifications

Caution

Do not modify the standard product using any of the optional specifications once the product has been supplied to a customer. Check the specifications carefully before selecting an air dryer. In addition, do not disassemble or modify the product. Products which have been disassembled and/or modified cannot be guaranteed.

■ Refrigerant with GWP reference

Refrigerant	Global warming potential (GWP)	
	Regulation (EU) No 517/2014 (Based on the IPCC AR4)	Revised Fluorocarbons Recovery and Destruction Law (Japanese law)
R134a	1,430	1,430
R404A	3,922	3,920
R407C	1,774	1,770
R410A	2,088	2,090

Note 1) This product is hermetically sealed and contains fluorinated greenhouse gases (HFC). When this product is sold on the market in the EU after January 1, 2017, it needs to be compliant with the quota system of the F-Gas Regulation in the EU.

Note 2) See specification table for refrigerant used in the product.