

Valve Mounted Guide Cylinder

MVGQ Series

ø12, ø16, ø20, ø25, ø32, ø40, ø50, ø63, ø80, ø100

Valve, Speed Controller, and Cylinder are formed into one unit.

Easy piping wiring work for Valve, Speed Controller and Cylinder can be formed into one unit, further can be equipped into a more compact design.

The optimum valve series for each bore size

ø12, ø16, ø20	ø25, ø32	ø40, ø50, ø63	ø80, ø100
Valve: SYJ3000	VZ3000	VZ5000	VF3000

Switching between rod extended when energized and rod retracted when energized is easy.

It is able to switch easily by changing the orientation of the switching plate for the SYJ3000, VZ3000, VZ5000 series, and by changing the mounting orientation of the valve for the VF3000 series.

Two kinds of guide rod bearings suited for individual use

Slide Bearing

Strength against side load is more than 2 times* as compared current stopper cylinder (round bar type). Suitable for use with lateral loads accompanied by impact, as in stoppers.

Ball Bushing Bearing

Smooth operation is suitable for pushing, lifter and applications. (*Comparison to SMC RSQ□ series, round bar type)

Can be mounted from two directions.

Non-rotating accuracy

Cylinder position can be detected.

Built-in magnet for auto-switches

Built-in speed controller

Selection of meter-out or meter-in control is possible.



CVQ

CVQM

CVJ□

CVM□

CV3

CVS1

MVGQ

Maximum Driving Speed of Cylinders

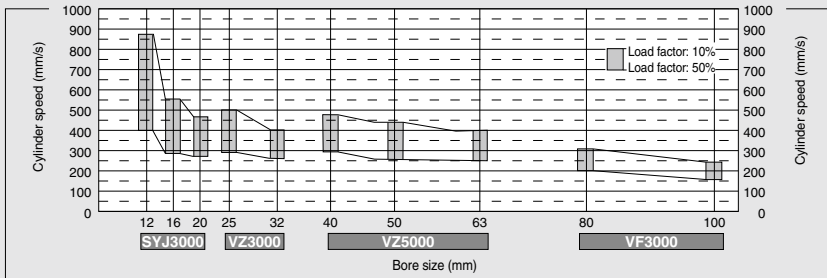

Series Variations

Bore size (mm)	Standard stroke (mm)											Applicable valve series	Positions/No. of solenoid	Effective area (mm ²) (Cv factor)	Detailed specifications		
	10	20	25	30	40	50	75	100	125	150	175					200	
12	●	●		●	●	●	●						SYJ3000	2 position	Single	1.2 (0.067)	P.852
16	●	●		●	●	●	●										
20		●	●	●	●	●	●	●	●	●	●	●	VZ3000	2 position	Single	4.5 (0.25)	P.856
25		●	●	●	●	●	●	●	●	●	●	●					
32			●	●	●	●	●	●	●	●	●	●					
40				●	●	●	●	●	●	●	●	●					
50					●	●	●	●	●	●	●	●	VZ5000	2 position	Double	12.5 (0.7)	
63					●	●	●	●	●	●	●	●					
80						●	●	●	●	●	●	●	VF3000	2 position	Single	16 (0.9)	
100						●	●	●	●	●	●	●					

D-□

-X□

Valve Mounted Guide Cylinder

MVGQ Series

ø12, ø16, ø20



How to Order

How to Order

When ordering valve mounted guide cylinder, the MVGQ series, specify the models of both the cylinder and the valve.

Ex.) MVGQM12-30-M9BWM-B 1
 SYJ3130-5LZ-MA 1

Cylinder stroke (mm)
 Refer to page 853 for standard strokes.

Bore size

12	12 mm
16	16 mm
20	20 mm

Bearing

M	Slide bearing
L	Ball bushing bearing

Number of auto switches

NII	2 pcs.
S	1 pc.
n	n pcs.

Auto switch

NII Without auto switch (Built-in magnet)
 * For the applicable auto switch model, refer to page 853.

Rod extended/retracted when energized

(Note)

NII	Rod extended when energized
B	Rod retracted when energized

(Note) Based on the case of 2 position single solenoid valve.

Cylinder

MVGQ **M** **12** - **30** - **M9BW** [] - [] - []

Valve

SYJ3 **1** **3** **0** [] - **5** **L** **Z** [] - **MA** - []

Type of actuation

1	2 position single solenoid
2	2 position double solenoid

* Please consult with SMC for 3 position type.

Speed controller specifications

MA	Meter-out
MB*	Meter-in

Made to Order

* Refer to page 853 for details.

* Semi-standard

Coil specification

NII	Standard
T	With energy saving circuit (24/12 VDC only)

* The energy saving circuit is not available for W□.

DC specifications **AC specifications (50/60 Hz)**

5	24 VDC	1	100 VAC
6	12 VDC	2	200 VAC
V	6 VDC	3	100 VAC [115 VAC]
S	5 VDC	4	220 VAC [230 VAC]
R	3 VDC	* W□: DC only	

200 VAC, 220 VAC specifications

An AC specification solenoid valve using a grommet, L, or M plug connector has a built-in rectifier circuit in its pilot valve section to activate the DC coil. The 200 VAC or 220 VAC specification pilot valve contains a rectifier circuit that generates heat when it is energized. Therefore, do not touch its exterior surface because it could be very hot, depending on the energizing conditions.

Body option

0: Pilot valve individual exhaust type

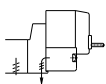

R port P/E port

3: Main/Pilot valve common exhaust type

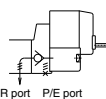

R port P/E port

Electrical entry

24 V, 12 V, 6 V, 5 V, 3 VDC		100 V, 110 V, 200 V, 220 VAC		24 V, 12 VDC		6 V, 5 V, 3 VDC	
Grommet	L plug connector	M plug connector	MN plug connector	M8 connector			
G: Lead wire length: 300 mm	L: With lead wire (Wire length: 300 mm)	M: With lead wire (Wire length: 300 mm)	MN: Without lead wire	WO: Without connector cable			
H: Lead wire length: 600 mm	LN: Without lead wire	LO: Without connector	MO: Without connector	W□: With connector cable			

* 2 sockets are attached to "LN" and "MN" types.

* Refer to page 872 for the connector cable for M8.

Note 1) □: Cable length symbol. Insert the symbol referring to page 872.

Manual override

NII: Non-locking push type

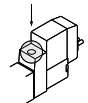

D: Push-turn locking slotted type

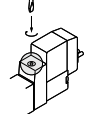

E: Push-turn locking lever type

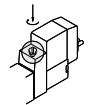

Light/Surge voltage suppressor

NII	Without light/surge voltage suppressor
S	With surge voltage suppressor
Z	With light/surge voltage suppressor
R	With surge voltage suppressor (No polarity)
U	With light/surge voltage suppressor (No polarity)

* In the case of AC, since the rectifier prevents the production of surge voltage, there is no type "S".

* R, U: DC only

* With energy saving circuit: For type "Z" only

Symbol

Meter-out
Rod extended
when energized

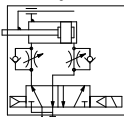

Rod retracted
when energized

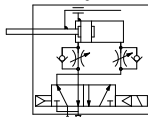

Meter-in (Semi-standard)
Rod extended
when energized

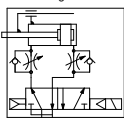

Rod retracted
when energized

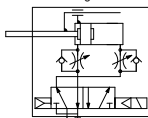

The allowable lateral load, the allowable rotational torque for a plate, and the operation range of a stopper are the same as these of the MGQ series. For details, refer to Best Pneumatics No. 2-2.

Standard Stroke

Model	Standard stroke (mm)
MVGQ ^M 12,16	10, 20, 30, 40, 50, 75, 100
MVGQ ^M 20	20, 30, 40, 50, 75, 100 125, 150, 175, 200

Intermediate stroke (mm)

As for the intermediate strokes (in 1 mm increments) other than the standard strokes above are manufactured by means of installing a spacer.
Example) In the case of MVGQM20-35 st, a 5 mm width spacer is installed in the MVGQM20-40 st body; thus, the full length dimension are the same as the 40 st.



Made to Order Specifications
[Click here for details](#)

Symbol	Specifications
-XA□	Change of guide rod end shape
-XC7□	Tapped hole, drilled hole, pinned hole machined additionally

Specifications

Bore size (mm)	12, 16, 20	
Action	Double acting	
Fluid	Air	
Bearing type	Slide bearing (MVGQM), Ball bushing bearing (MVGQL)	
Operating pressure range (MPa)	2 position single	0.15 to 0.7
	2 position double	0.12, 0.16: 0.12 to 0.7, 0.20: 0.1 to 0.7
Ambient and fluid temperature (°C)	-10 to 50°C (No freezing)	
Piston speed (mm/s)	50 to 500 (Refer to the page 851.)	
Cushion	Rubber bumper on both ends	
Lubrication	Non-lube	
Stroke length tolerance (mm)	+1.5 0	

Solenoid Valve Specifications

Model		SYJ3000 series	
Manual override		Non-locking push type, Push-turn locking slotted type, Push-turn locking lever type	
Pilot exhaust		Pilot valve individual exh. type, Main/Pilot valve common exh. type	
Impact/Vibration resistance (m/s ²) ⁽¹⁾		150/30	
Enclosure		Dustproof (* M8 connector: IP65)	
Electrical entry		Grommet (G)/(H), L plug connector (L), M plug connector (M), M8 connector (W)	
Coil rated voltage (V)	DC	24, 12, 6, 5, 3	
	AC50/60 Hz	100*, 110*, 200*, 220*	
Allowable voltage		±10% of the rated voltage*	
Power consumption ⁽²⁾ (VA)	DC	Standard type	0.35 (With indicator light: 0.4)
		With energy saving circuit	0.1 (With indicator light only)
	AC	100 V	0.78 (With indicator light: 0.81)
		110 V [115 V]	0.86 (With indicator light: 0.89) [0.94 (With indicator light: 0.97)]
200 V	1.18 (With indicator light: 1.22)		
	220 V [230 V]	1.30 (With indicator light: 1.34) [1.42 (With indicator light: 1.46)]	
Surge voltage suppressor		Diode (Non-polar type: Varistor)	
Indicator light		LED	

* Conforming to IEC60529
 = 100 VAC and 115 VAC, 200 VAC and 230 VAC are common.
 * Allowable voltage fluctuation for 115 VAC or 230 VAC is -15 to +5% of the rated voltage.
 * For types S, Z and T with an energy saving circuit, the voltage will drop due to the internal circuit. Allowable voltage fluctuation must be in the range below.
 Types S, Z 24 VDC: -7 to +10%, 12 VDC: -4 to +10%
 Type T 24 VDC: -8 to +10%, 12 VDC: -6 to +10%
 Note 1) Impact resistance: No malfunction resulted from the impact test using a drop impact tester. The test was performed on the axis and right angle directions of the main valve and armature, one time each in both energized and de-energized states.
 Vibration resistance: No malfunction occurred in a one-sweep test between 45 and 2000 Hz. Test was performed at both energized and de-energized states to the axis and right angle directions of the main valve and armature. (Value in the initial stage.)
 Note 2) At the rated voltage.

Applicable Auto Switches/Refer to pages 941 to 1067 for further information on auto switches.

Type	Special function	Electrical entry	Indicator type	Wiring (Output)	Load voltage		Auto switch model		Lead wire length (m)				Pre-wired connector	Applicable load	
					DC	AC	Perpendicular	In-line	0.5 (Nil)	1 (M)	3 (L)	5 (Z)			
Solid state auto switch	Diagnostic indication (2-color indicator)	Grommet	Yes	3-wire (NPN)	5 V, 12 V	—	M9NV	M9N	●	●	○	○	○	IC circuit	Relay, PLC
				3-wire (PNP)			M9PV	M9P	●	●	○	○	○	IC circuit	
				2-wire	M9BV		M9B	●	●	○	○	○	○	—	
	3-wire (NPN)			M9NWV	M9NW		●	●	○	○	○	○	IC circuit		
	3-wire (PNP)			M9PWV	M9PW		●	●	○	○	○	○	IC circuit		
	2-wire			M9BWV	M9BW		●	●	○	○	○	○	○	—	
Reed auto switch	Water resistant (2-color indicator)	Grommet	Yes	3-wire (NPN equivalent)	5 V	—	M9NAV ^{*1}	M9NA ^{*1}	○	○	●	●	—	IC circuit	Relay, PLC
				3-wire (PNP)			M9PAV ^{*1}	M9PA ^{*1}	○	○	●	●	—	IC circuit	
				2-wire	M9BAV ^{*1}		M9BA ^{*1}	○	○	●	●	—	—		
				2-wire	A96V		A96	●	—	●	—	—	—	IC circuit	
No	2-wire	24 V	12 V	100 V	A93V ^{*2}	A93	●	●	●	—	—	—	Relay, PLC		
				100 V or less	A90V	A90	●	—	●	—	—	—	IC circuit		

*1 Water resistant type auto switches can be mounted on the above models, but in such case SMC cannot guarantee water resistance.

Consult with SMC regarding water resistant types with the above model numbers.

*2 2 m type lead wire is only applicable to D-A93.

* Lead wire length symbols: 0.5 m Nil (Example) M9NW 3 m L (Example) M9NWL * Solid state auto switches marked with "○" are produced upon receipt of order.

* Since there are other applicable auto switches than listed, refer to page 969 for details.

* For details about auto switches with pre-wired connector, refer to pages 1014 and 1015.

* Auto switches are shipped together (not assembled).

CVQ

CVQM

CVJ□

CVM□

CV3

CVS1

MVGQ

D-□

X-□

MVGQ Series

Weight

(kg)

Bearing type	Bore size (mm)	Type	Standard stroke (mm)											
			10	20	30	40	50	75	100	125	150	175	200	
Slide bearing	12	MVGQM12	0.23	0.28	0.32	0.35	0.39	0.49	0.59	-	-	-	-	
	16	MVGQM16	0.35	0.40	0.46	0.51	0.56	0.69	0.81	-	-	-	-	
	20	MVGQM20	-	0.55	0.62	0.70	0.77	0.95	1.10	1.25	1.40	1.55	1.70	
Ball bushing bearing	12	MVGQL12	0.24	0.27	0.30	0.36	0.39	0.47	0.54	-	-	-	-	
	16	MVGQL16	0.36	0.40	0.45	0.53	0.58	0.71	0.83	-	-	-	-	
	20	MVGQL20	-	0.55	0.61	0.71	0.76	0.91	1.05	1.19	1.33	1.47	1.61	

Note) The factors indicated above are of the single solenoid with grommet (G). Add 0.01 kg for the double solenoids.

Changing between Rod Extended when Energized and Rod Retracted when Energized

SYJ3000

How to Handle Speed Controller

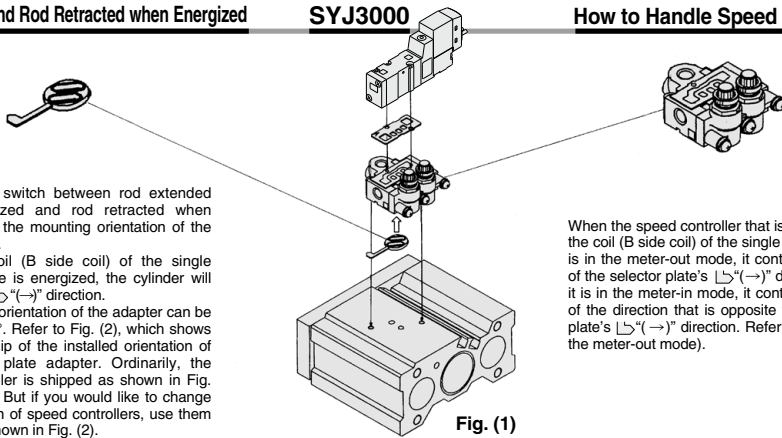

It is able to switch between rod extended when energized and rod retracted when energized by the mounting orientation of the selector plate.

When the coil (B side coil) of the single solenoid valve is energized, the cylinder will move in the \rightarrow direction.

The installed orientation of the adapter can be changed 180°. Refer to Fig. (2), which shows the relationship of the installed orientation of the selector plate adapter. Ordinarily, the speed controller is shipped as shown in Fig. (2) (a) or (b). But if you would like to change the orientation of speed controllers, use them in (c) or (d) shown in Fig. (2).

When the speed controller that is on the side of the coil (B side coil) of the single solenoid valve is in the meter-out mode, it controls the speed of the selector plate's \rightarrow direction. When it is in the meter-in mode, it controls the speed of the direction that is opposite to the selector plate's \rightarrow direction. Refer to Fig. (3) (for the meter-out mode).

Fig. (2)

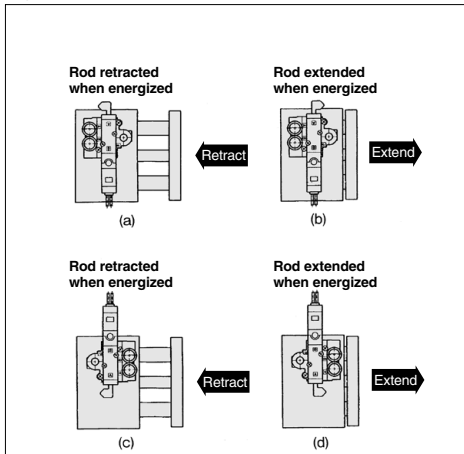
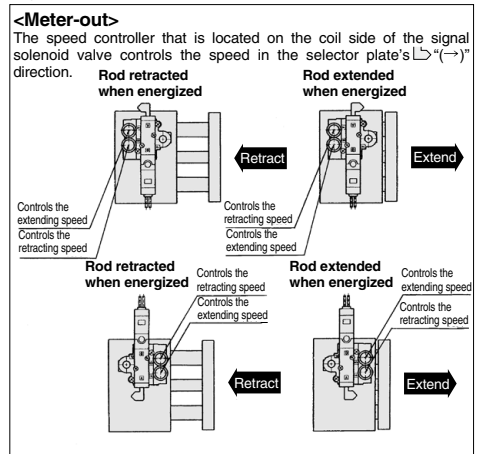

Fig. (3)



Valve Mounted Guide Cylinder

MVGQ Series

ø25, ø32, ø40, ø50, ø63



How to Order

How to Order

When ordering valve mounted guide cylinder, the MVGQ series, specify the models of both the cylinder and the valve.

Ex.) MVGQM25-30-M9BWM-B 1
VZ3140-5LZ-MA 1

Cylinder stroke (mm)
Refer to page 857 for standard strokes.

		Bore size			
25	25 mm	VZ3000 series	40	40 mm	VZ5000 series
32	32 mm		50	50 mm	
			63	63 mm	

Bearing	
M	Slide bearing
L	Ball bushing bearing

Cylinder

MVGQ M 25 - 30 - M9BW

Valve

VZ 3 1 4 0 - 5 L - MA

Valve series

3	VZ3000 series
5	VZ5000 series

Type of actuation

1	2 position single solenoid
2	2 position double solenoid

* Please consult with SMC for 3 position type.

Body option

0: Pilot valve individual exhaust type



R port P/E port

3: Main/Pilot valve common exhaust type



R port P/E port

Rated voltage

1	100 VAC 50/60 Hz
2	200 VAC 50/60 Hz
3*	110 VAC 50/60 Hz
4*	220 VAC 50/60 Hz
5	24 VDC
6*	12 VDC

* Semi-standard
For other rated voltages, please consult with SMC.

Auto switch

Nil	Without auto switch (Built-in magnet)
-----	---------------------------------------

* For the applicable auto switch model, refer to page 857.

Number of auto switches

Nil	2 pcs.
S	1 pc.
n	n pcs.

Rod extended/retracted when energized

Nil	Rod extended when energized
B	Rod retracted when energized

Note) Based on the case of 2 position single solenoid valve.

Made to Order

= Refer to page 857 for details.

Speed controller specifications

MA	Meter-out
MB*	Meter-in

* Semi-standard

Port thread type

Nil	Rc
N	NPT
F	G

Manual override

Nil: Non-locking push type



B: Locking type B (Slotted)



C: Locking type C (Manual)



Light/Surge voltage suppressor

Nil	Without light/surge voltage suppressor
S	With surge voltage suppressor
Z (Note)	With light/surge voltage suppressor

Note) "GZ", "HZ" and "DOZ" are not available.

Electrical entry

Grommet	L plug connector	M plug connector		DIN terminal
G: Lead wire length: 300 mm	L: With lead wire (Wire length: 300 mm)	M: With lead wire (Wire length: 300 mm)	MN: Without lead wire	D: With connector
H: Lead wire length: 600 mm	LN: Without lead wire	LO: Without connector	MO: Without connector	DO: Without connector

* 2 sockets are attached to "LN" and "MN" types.

Symbol

Meter-out

Rod extended when energized

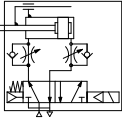

Rod retracted when energized

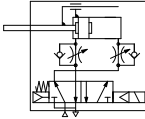

Meter-in (Semi-standard)

Rod extended when energized

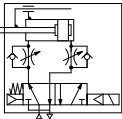

Rod retracted when energized

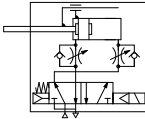

Made to Order Specifications

[Click here for details](#)

Symbol	Specifications
-XA	Change of guide rod end shape
-XC79	Tapped hole, drilled hole, pinned hole machined additionally

Specifications

Bore size (mm)	25, 32, 40, 50, 63	
Action	Double acting	
Fluid	Air	
Bearing type	Slide bearing (MVGQM), Ball bushing bearing (MVGQL)	
Operating pressure range (MPa)	2 position single	0.15 to 0.7
	2 position double	0.1 to 0.7
Ambient and fluid temperature (°C)	-10 to 50°C (No freezing)	
Piston speed (mm/s)	50 to 500 (Refer to the page 851)	
Cushion	Rubber bumper on both ends	
Lubrication	Non-lube	
Stroke length tolerance (mm)	+1.5 0	

Solenoid Valve Specifications

Model		VZ3000/VZ5000 series	
Manual override	Non-locking push type, Locking slotted type, Locking lever type		
Pilot exhaust	Pilot valve individual exh. type, Main/Pilot valve common exh. type		
Mounting orientation	Universal		
Impact/Vibration resistance (m/s ²) ⁽¹⁾	300/50		
Enclosure	Dust proof		
Electrical entry	Grommet (G)/(H), L plug connector (L), M plug connector (M), DIN terminal (D)		
	Coil rated voltage (V)	AC50/60Hz	100, 200, 24 [®] , 48 [®] , 110 [®] , 220 [®]
DC		24, 6 [®] , 12 [®] , 48 [®]	
Allowable voltage (%)	-15 to 10% of the rated voltage		
Power consumption (W) [Current: mA] ⁽²⁾	DC	1.8 (With indicator light: 2.1) [24 VDC: 75 (With light: 87.5)]	
		Start-up	4.5 to 50 Hz, 4.2/60 Hz [100 VAC: 45/50 Hz, 42/60 Hz; 200 VAC: 22.5/50 Hz, 21/60 Hz]
Apparent power (VA) [Current: mA] ⁽²⁾	AC	3.5/50 Hz, 3/60 Hz	[100 VAC: 35/50 Hz, 30/60 Hz; 200 VAC: 17.5/50 Hz, 15/60 Hz]
		Surge voltage suppressor	DC: Diode, AC: Varistor
Indicator light	DC: LED (Red), AC: Neon bulb		

* Semi-standard

Note 1) Impact resistance: No malfunction resulted from the impact test using a drop impact tester. The test was performed on the axis and right angle direction of the main valve and armature, one time each in both energized and de-energized states.

Vibration resistance: No malfunction occurred in a one-sweep test between 45 and 2000 Hz. Test was performed at both energized and de-energized states to the axis and right angle direction of the main valve and armature. (Value in the initial stage.)

Note 2) At the rated voltage.

Standard Stroke

Model	Standard stroke (mm)	Intermediate stroke (mm)
MVGQ ^M 25	20, 30, 40, 50, 75, 100 125, 150, 175, 200	
MVGQ ^M 32, 40 50, 63	25, 50, 75, 100, 125, 150, 175, 200	

* As for the intermediate strokes (by the 1 stroke interval) for ø25, ø32 other than the standard strokes at left are manufactured by means of installing a spacer.
Ex.) In the case of MVGQM25-21 st, an interface of 9 mm wide (5 mm + 4 mm) is installed inside of the MVGQ20-30 st, and thus the full length dimension of the body is the same as 30 st.
* As for the intermediate strokes (by the 5 stroke interval) for ø40 to ø63 other than the standard strokes at left are manufactured by means of installing a spacer.
Ex.) In the case of MVGQM50-40 st, an interface of 10 mm wide is installed inside of the MVGQ50-50 st, and thus the full length dimension of the body is the same as 50 st.

Applicable Auto Switches/Refer to pages 941 to 1067 for further information on auto switches.

Type	Special function	Electrical entry	Indicator light	Wiring (Output)	Load voltage		Auto switch model		Lead wire length (m)					Pre-wired connector	Applicable load
					DC	AC	Perpendicular	In-line	0.5 (Ni)	1 (M)	3 (L)	5 (Z)			
Solid state auto switch	Diagnostic indication (2-color indicator)	Grommet	Yes	3-wire (NPN)	5 V, 12 V	—	—	M9NV	M9N	●	●	○	○	○	IC circuit
				3-wire (PNP)				M9PV	M9P	●	●	○	○	Relay, PLC	
				2-wire	M9BV			M9B	●	●	○	○	—		
				3-wire (NPN)	M9NVW			M9NW	●	●	○	○			
	Water resistant (2-color indicator)	Grommet	Yes	3-wire (PNP)	5 V, 12 V			M9PWV	M9PW	●	●	○	○		○
				2-wire				M9BWV	M9BW	●	●	○	○	—	
				3-wire (NPN)	M9NAV ^{*1}			M9NA ^{*1}	○	○	●	●	IC circuit		
				3-wire (PNP)	M9PAV ^{*1}			M9PA ^{*1}	○	○	○	○		IC circuit	
Reed auto switch	—	Grommet	No	3-wire (NPN equivalent)	—	5 V	—	A96V	A96	●	—	●	—		—
				2-wire	24 V	12 V	100 V	A93V ^{*2}	A93	●	●	●	—	—	Relay, PLC
								A90V	A90	●	—	●	—	—	IC circuit

*1 Water resistant type auto switches can be mounted on the above models, but in such case SMC cannot guarantee water resistance.

Consult with SMC regarding water resistant types with the above model numbers.

*2 1 m type lead wire is only applicable to D-A93.

* Lead wire length symbols: 0.5 m Ni (Example) M9NW
1 m M (Example) M9NWM
3 m L (Example) M9NWL
5 m Z (Example) M9NWLZ

* Solid state auto switches marked with "○" are produced upon receipt of order.

* Since there are other applicable auto switches than listed, refer to page 869 for details.

* For details about auto switches with pre-wired connector, refer to pages 1014 and 1015.

* Auto switches are shipped together (not assembled).

CVQ

CVQM

CVJ

CVM

CV3

CVS1

MVGQ

D-□

X-□

MVGQ Series

Weight

(kg)

Bearing type	Bore size (mm)	Model	Standard stroke (mm)											
			20	25	30	40	50	75	100	125	150	175	200	
Slide bearing	25	MVGQM25	0.96	-	1.06	1.17	1.26	1.57	1.81	2.05	2.29	2.53	2.77	
	32	MVGQM32	-	1.64	-	-	2.04	2.42	2.82	3.22	3.62	4.02	4.42	
Ball bushing bearing	25	MVGQL25	0.97	-	1.06	1.21	1.30	1.50	1.71	1.92	2.13	2.34	2.55	
	32	MVGQL32	-	1.45	-	-	1.80	2.22	2.58	2.94	3.30	3.66	4.02	

The allowable lateral load, the allowable rotational torque for a plate, and the operation range of a stopper are the same as those of the MGQ series. For details, refer to Best Pneumatics No. 2-2.

Note) The factors indicated above are of the single solenoid with grommet (G). Add 0.05 kg for the double solenoids.

Changing between Rod Extended when Energized and Rod Retracted when Energized

VZ3000

How to Handle Speed Controller

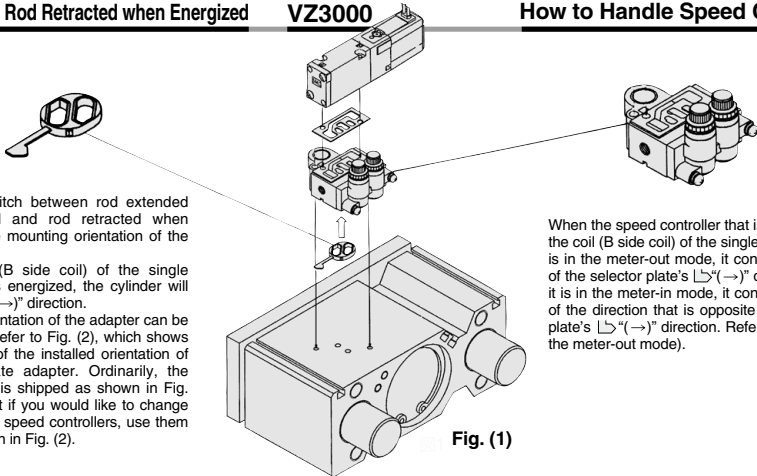

It is able to switch between rod extended when energized and rod retracted when energized by the mounting orientation of the selector plate.

When the coil (B side coil) of the single solenoid valve is energized, the cylinder will move in the \rightarrow ("→") direction.

The installed orientation of the adapter can be changed 180°. Refer to Fig. (2), which shows the relationship of the installed orientation of the selector plate adapter. Ordinarily, the speed controller is shipped as shown in Fig. (2) (a) or (b). But if you would like to change the orientation of speed controllers, use them in (c) or (d) shown in Fig. (2).

When the speed controller that is on the side of the coil (B side coil) of the single solenoid valve is in the meter-out mode, it controls the speed of the selector plate's \rightarrow ("→") direction. When it is in the meter-in mode, it controls the speed of the direction that is opposite to the selector plate's \rightarrow ("→") direction. Refer to Fig. (3) for the meter-out mode.

Fig. (1)

Fig. (2)

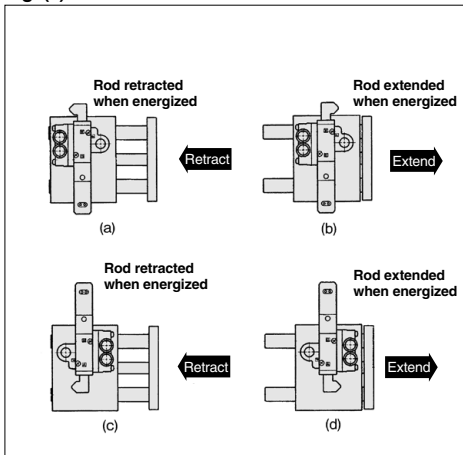
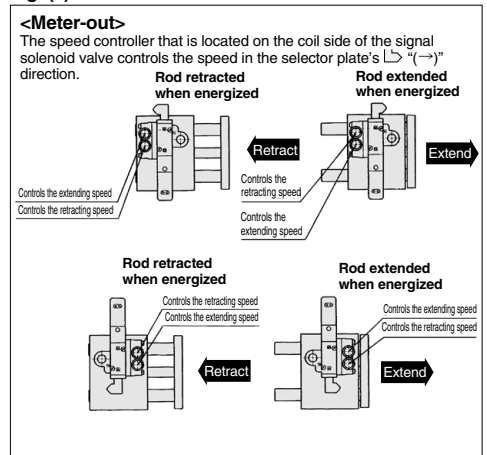

Fig. (3)



Weight

(kg)

Bearing type	Bore size (mm)	Model	Standard stroke (mm)							
			25	50	75	100	125	150	175	200
Slide bearing	40	MVQM40	1.91	2.50	2.72	3.13	3.54	3.95	4.36	4.77
	50	MVQM50	2.80	3.35	3.91	4.47	5.03	5.59	6.15	6.71
	63	MVQM63	3.27	3.89	4.49	5.11	5.73	6.35	6.97	7.59
Ball bushing bearing	40	MVQL40	1.72	2.08	2.53	2.89	3.25	3.61	3.97	4.33
	50	MVQL50	2.37	2.85	3.45	3.94	4.43	4.92	5.41	5.90
	63	MVQL63	2.91	3.45	4.11	4.65	5.19	5.73	6.27	6.81

Note) The factors indicated above are of the single solenoid with grommet (G). Add 0.04 kg for the double solenoids.

Changing between Rod Extended when Energized and Rod Retracted when Energized

VZ5000

How to Handle Speed Controller

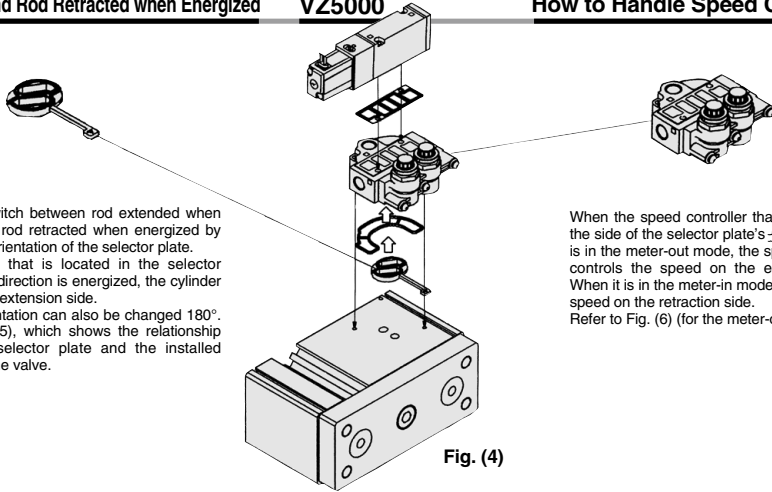

It is able to switch between rod extended when energized and rod retracted when energized by the mounting orientation of the selector plate. When the coil that is located in the selector plate's \rightarrow direction is energized, the cylinder moves into the extension side. The valve orientation can also be changed 180°. Refer to Fig. (5), which shows the relationship between the selector plate and the installed orientation of the valve.

When the speed controller that is located on the side of the selector plate's \rightarrow direction is in the meter-out mode, the speed controller controls the speed on the extension side. When it is in the meter-in mode, it controls the speed on the retraction side. Refer to Fig. (6) (for the meter-out mode).

Fig. (4)

Fig. (5)

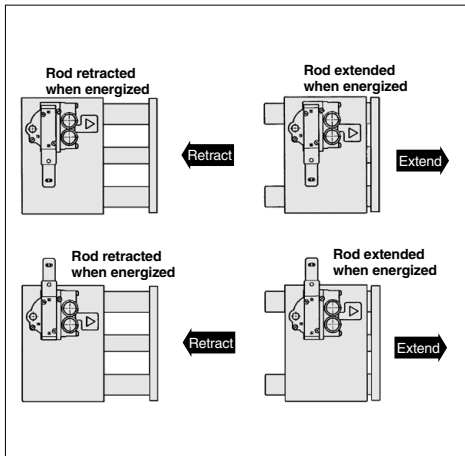
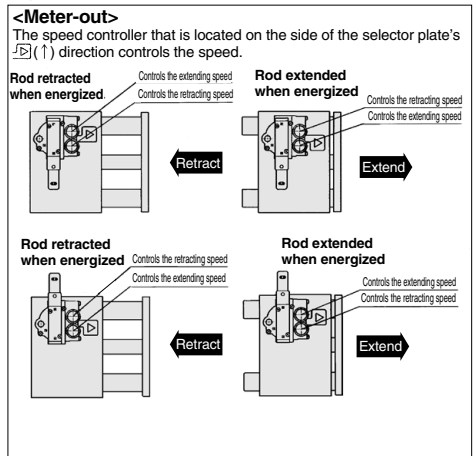

Fig. (6)



CVQ

CVQM

CVJ

CVM

CV3

CVS1

MVGQ

D-

X-

MVGQ Series

ø25, ø32

MVGQM, MVGQL

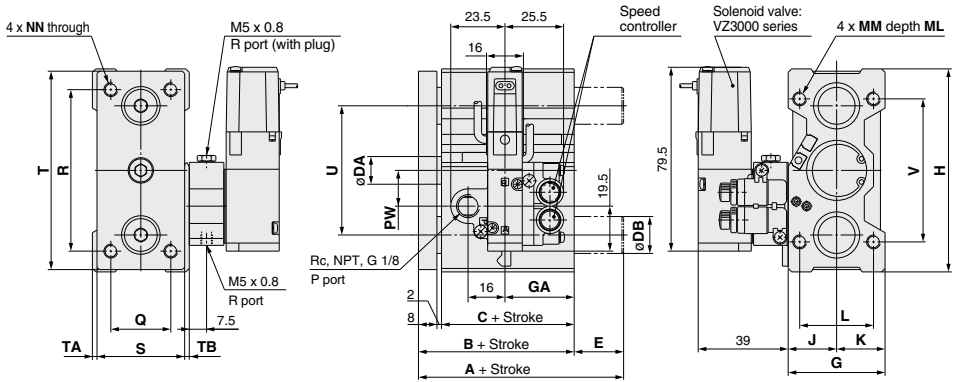
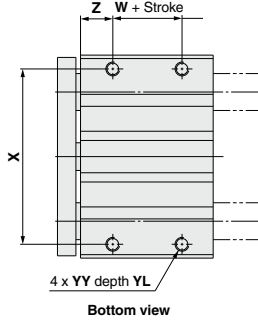

* The figures show when attached to VZ3140-□G.
 * [] : Denotes AC.

MVGQM, MVGQL Common Dimensions

Bore size (mm)	Standard stroke (mm)	Applicable solenoid valve	B	C	DA	G	GA		H	J	K	L	MM	ML	NN	PW	Q	R	S	T	TA	TB	U	V	W	X	YY	YL	Z
							20 st	Over 20 st																					
25	20, 30, 40, 50, 75, 100, 125, 150, 175, 200	VZ3000 series	47.5	37.5	12	42	30	35	88	21	21	32	M6 x 1.0	15	M6 x 1.0	15.5	26	70	38	86	2	2	56	62	10	76	M6 x 1.0	9	14
32	25, 50, 75, 100, 125, 150, 175, 200	VZ3000 series	47.5	37.5	16	51	35	114	25	26	38	M8 x 1.25	20	M8 x 1.25	22	30	96	48	112	2	1	80	80	5	100	M8 x 1.25	11	16	
																													35

Note 1) It is possible to manufacture the intermediate strokes other than the standard strokes by means of installing a spacer.
 Note 2) For the electrical entry except the grommet type, refer to page 856.

MVGQM (Slide bearing) A, DB, E Dimensions

Bore size (mm)	Symbol	A		DB	E	
		Up to 50 st	Over 50 st		Up to 50 st	Over 50 st
25	Stroke	47.5	62	16	0	14.5
32	Stroke	71.5		20	24	

MVGQL (Ball bushing bearing) A, DB, E Dimensions

Bore size (mm)	Symbol	A		DB	E	
		Up to 30 st	Over 30 st		Up to 30 st	Over 30 st
25	Stroke	63.5	79.5	13	16	32
		53	90		16	5.5
32	Stroke	63.5	79.5	13	16	32
		53	90		16	5.5

ø40, ø50, ø63

MVGQM, MVGQL

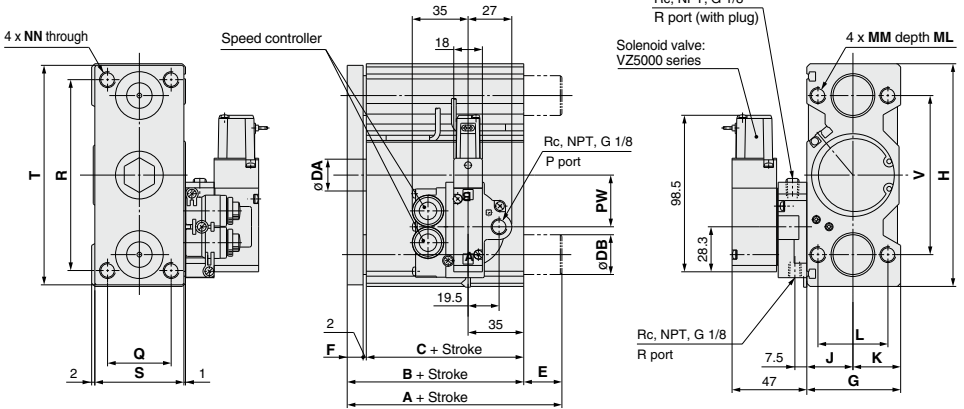
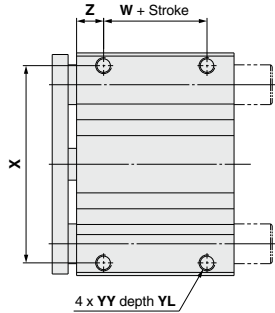

* The figures show when attached to VZ5140-□G.

MVGQM, MVGQL Common Dimensions

Bore size (mm)	Standard stroke (mm)	Applicable solenoid valve	(mm)																						
			B	C	DA	F	G	H	J	K	L	MM	ML	NN	PW	Q	R	S	T	V	W	X	YY	YL	Z
40	25, 50, 75, 100,	VZ5000 series	54	44	16	8	51	124	25	26	38	M8 x 1.25	20	M8 x 1.25	27	30	106	48	122	90	10	110	M8 x 1.25	11	17
50	125, 150, 175, 200		56	44	20	10	59	140	29	30	44	M10 x 1.5	25	M10 x 1.5	32.5	40	120	56	138	100	10	124	M10 x 1.5	12.5	17
63			61	49	20	10	72	150	35.5	36.5	44	M10 x 1.5	25	M10 x 1.5	29.8	50	130	69	148	110	10	132	M10 x 1.5	15	19

Note 1) It is possible to manufacture the intermediate strokes other than the standard strokes by means of installing a spacer.
 Note 2) For the electrical entry except the grommet type, refer to page 856.

MVGQM (Slide bearing) A, DB, E Dimensions

Bore size (mm)	Symbol	A	DB	E
40		71.5	20	17.5
50		81	25	25
63		81	25	20

MVGQL (Ball bushing bearing) A, DB, E Dimensions

Bore size (mm)	Symbol	A		DB	E	
		Up to 50 st	Over 50 st		Up to 50 st	Over 50 st
40		54	90	16	0	36
50		60	102	20	4	46
63		61	102	20	0	41

CVQ

CVQM

CVJ

CVM

CV3

CVS1

MVGQ

D-

-X

Valve Mounted Guide Cylinder

MVGQ Series

ø80, ø100

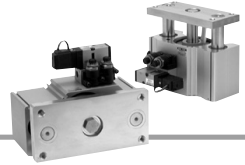

How to Order

How to Order

When ordering valve mounted guide cylinder, the MVGQ series, specify the models of both the cylinder and the valve.

Ex.) MVGQM80-50-M9BWM-B 1
VF3140-5LZ-MA 1

Cylinder stroke (mm)
Refer to page 863 for standard strokes.

Bore size	
80	90 mm
100	100 mm

Bearing	
M	Slide bearing
L	Ball bushing bearing

Auto switch

Nll	Without auto switch (Built-in magnet)
-----	---------------------------------------

* For the applicable auto switch model, refer to page 863.

Number of auto switches

Nll	2 pcs.
S	1 pc.
n	n pcs.

Rod extended/retracted when energized

Nll	Rod extended when energized
B	Rod retracted when energized

(Note) Based on the case of 2 position single solenoid valve.

Cylinder

MVGQ **M** **80** - **50** - **M9BW** [] - [] - []

Valve

VF3 **1** **4** **0** - **5** **L** **Z** [] - **MA** [] - []

Type of actuation

1	2 position single solenoid
2	2 position double solenoid

* Please consult with SMC for 3 position type.

Body option

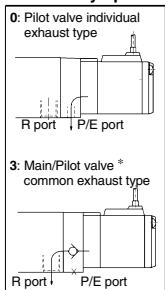

Rated voltage

1	100 VAC, 50/60 Hz
2	200 VAC, 50/60 Hz
3*	110 to 120 VAC, 50/60 Hz
4*	220 VAC, 50/60 Hz
5	24 VDC
6*	12 VDC
7*	240 VAC, 50/60 Hz

Maximum rated voltage for L/M type plug connectors is 220 VAC.
* Semi-standard
For other rated voltages, please consult with SMC.

Speed controller specifications

MA	Meter-out
MB *	Meter-in

* Semi-standard

Manual override

Nll: Non-locking push type Manual override



Port thread type

Nll	Rc
N	NPT
F	G

B: Locking type B (Slotted) Manual override

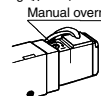

C: Locking type C (Manual) Manual override

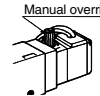

• Made to Order
* Refer to page 863 for details.

Light/Surge voltage suppressor

Nll	Without light/surge voltage suppressor
S ⁽¹⁾	With surge voltage suppressor
Z ⁽²⁾	With light/surge voltage suppressor

Note 1) Applicable to the grommet type only.
Note 2) "GZ", "HZ" are not available.

Electrical entry

G	Grommet (Lead wire length: 300 mm)	L	L plug connector	With lead wire
H	Grommet (Lead wire length: 600 mm)	LO	LO connector	Without connector
E	Grommet terminal	M	M plug connector	With lead wire
T	Conduit terminal	MO	MO connector	Without connector
		D	DIN terminal	With connector
		DO	DO terminal	Without connector

Symbol

Meter-out

Rod extended when energized

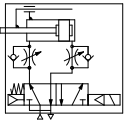

Rod retracted when energized

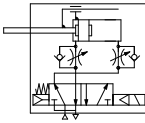

Meter-in (Semi-standard)

Rod extended when energized

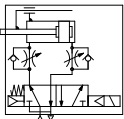

Rod retracted when energized

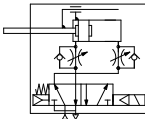

Made to Order Specifications
[Click here for details](#)

Symbol	Specifications
-XA□	Change of guide rod end shape
-XC79	Tapped hole, drilled hole, pinned hole machined additionally

Specifications

Bore size (mm)	80, 100	
Action	Double acting	
Fluid	Air	
Bearing type	Slide bearing (MVGQM), Ball bushing bearing (MVGQL)	
Operating pressure range (MPa)	2 position single	0.15 to 0.9
	2 position double	0.1 to 0.9
Ambient and fluid temperature (°C)	-10 to 50°C (No freezing)	
Piston speed (mm/s)	50 to 350 (Refer to the page 851)	
Cushion	Rubber bumper on both ends	
Lubrication	Non-lube	
Stroke length tolerance (mm)	+1.5 0	

Solenoid Valve Specifications

Model		VF3000 series	
Manual override		Non-locking push type, Locking B type*, Locking C type*	
Pilot exhaust		Pilot valve individual exh. type, Main/Pilot valve common exh. type	
Mounting orientation		Universal	
Impact/Vibration resistance (m/s.) ⁽¹⁾		300/50	
Enclosure		Dustproof	
Electrical entry Grommet, Grommet terminal, Conduit terminal, DIN terminal, L plug connector, M plug connector			
Coil rated voltage (V)	AC50/60 Hz	100, 200, 12*, 24*, 48*, 110*, 220*, 240*	
	DC	24, 6*, 12*, 48*, 100*, 110*	
Allowable voltage -15% to 10% of the rated voltage			
Apparent power ⁽²⁾	AC	Inrush	5.6 VA (50 Hz), 5.0 VA (60 Hz)
		Holding	3.4 VA (50 Hz), 2.3 VA (60 Hz)
Power consumption (W) ⁽²⁾	DC	1.8, 2 (With indicator light)	
	AC	Varistor, Neon bulb (LED for less than 100 V)	
Light/Surge voltage suppressor	AC	Varistor, Neon bulb (LED for less than 100 V)	
	DC	Varistor, LED (Neon bulb for 100 V or more)	

Note 1) Impact resistance: No malfunction resulted from the impact test using a drop impact tester. The test was performed on the axis and right angle direction of the main valve and armature, one time each in both energized and de-energized states.
 Vibration resistance: No malfunction occurred in a one-sweep test between 45 and 2000 Hz. Test was performed at both energized and de-energized states to the axis and right angle direction of the main valve and armature. (Value in the initial stage.)

Note 2) At the rated voltage.
 * Semi-standard

Standard Stroke

Model	Standard stroke (mm)	Intermediate stroke (mm)
MVGQ M 80,100	25, 50, 75, 100 125, 150, 175, 200	As for the intermediate strokes (by the 5 stroke interval) other than the standard strokes at left are manufactured by means of installing a spacer with the width of 5, 10, 15, 20 mm. (Ex.) In the case of MVGQM80-40 st, an interface of 10 mm wide is installed inside of the MVGQM80-50 st, and thus the full length dimension of the body is the same as 50 st.

Applicable Auto Switches/Refer to pages 941 to 1067 for further information on auto switches.

Type	Special function	Electrical entry	Indicator light	Wiring (Output)	Load voltage		Auto switch model		Lead wire length (m)					Pre-wired connector	Applicable load
					DC	AC	Perpendicular (Nil)	In-line	0.5 (M)	1 (L)	3 (Z)	5 (Z)			
Solid state auto switch	—	Grommet	Yes	3-wire (NPN)	5 V, 12 V	—	M9NV	M9N	●	●	○	○	○	Relay, PLC	
				3-wire (PNP)			M9PV	M9P	●	●	○	○	circuit		
				2-wire	M9BV		M9B	●	●	○	○	—			
	3-wire (NPN)			M9NVW	M9NW		●	●	○	○	IC				
	3-wire (PNP)			M9PVW	M9PW		●	●	○	○	circuit				
	2-wire			M9BWW	M9BW		●	●	○	○	—				
Diagnostic indication (2-color indicator)	Water resistant (2-color indicator)	3-wire (NPN)	5 V, 12 V	M9NAV ^{*1}	M9NA ^{*1}	○	○	●	○	○	○	IC			
		3-wire (PNP)		M9PAV ^{*1}	M9PA ^{*1}	○	○	●	○	○	circuit				
		2-wire	M9BAV ^{*1}	M9BA ^{*1}	○	○	●	○	○	—					
Reed auto switch	—	Grommet	Yes	3-wire (NPN equivalent)	— 5 V	—	A96V	A96	●	—	—	—	IC		
				2-wire			A96V	A96	●	—	—	—	circuit		
				No	24 V 12 V		100 V 100 V or less	A93V ^{*2}	A93	●	●	●	●	—	Relay, PLC
				2-wire	24 V 12 V	100 V or less	A90V	A90	●	—	—	—	IC circuit		

*1 Water resistant type auto switches can be mounted on the above models, but in such case SMC cannot guarantee water resistance. Consult with SMC regarding water resistant types with the above model numbers.

*2 1 m type lead wire is only applicable to D-A93.

* Lead wire length symbols: 0.5 m Nil (Example) M9NVW
 1 m M (Example) M9NWM
 3 m L (Example) M9NWL
 5 m Z (Example) M9NVZ

* Solid state auto switches marked with "○" are produced upon receipt of order.

* Since there are other applicable auto switches than listed, refer to page 869 for details.

* For details about auto switches with pre-wired connector, refer to pages 1014 and 1015.

* Auto switches are shipped together (not assembled).

CVQ

CVQM

CVJ

CVM

CV3

CVS1

MVGQ

D

X

MVGQ Series

Weight

(kg)

Bearing type	Bore size (mm)	Model	Standard stroke (mm)							
			25	50	75	100	125	150	175	200
Slide bearing	80	MVGQM80	6.15	7.08	7.98	8.90	9.82	10.73	11.66	12.58
	100	MVGQM100	9.45	10.76	12.06	13.39	14.72	16.05	17.38	18.71
Ball bushing bearing	80	MVGQL80	5.98	6.87	8.44	9.28	10.12	10.96	11.80	12.64
	100	MVGQL100	8.83	10.02	12.27	13.45	14.63	15.81	16.99	18.17

Note) The factors indicated above are of the single solenoid with grommet (G). Add 0.08 kg for the double solenoids.

The allowable lateral load, the allowable rotational torque for a plate, and the operation range of a stopper are the same as those of the MGQ series. For details, refer to Best Pneumatics No. 2-2.

Changing between Rod Extended when Energized and Rod Retracted when Energized

It is able to switch between rod extended when energized and rod retracted when energized by the mounting orientation of the valve. Refer to Fig. (2).

VF3000

How to Handle Speed Controller

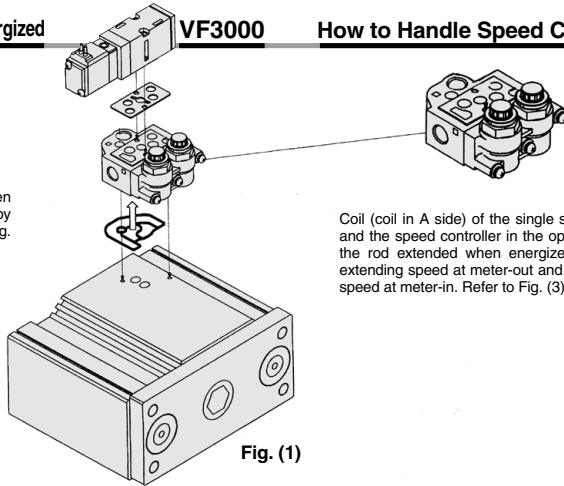

Fig. (1)

Coil (coil in A side) of the single solenoid valve and the speed controller in the opposite side at the rod extended when energized control the extending speed at meter-out and the retracting speed at meter-in. Refer to Fig. (3).

Fig. (2)

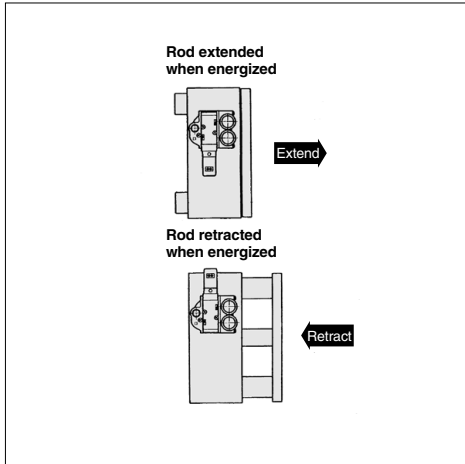
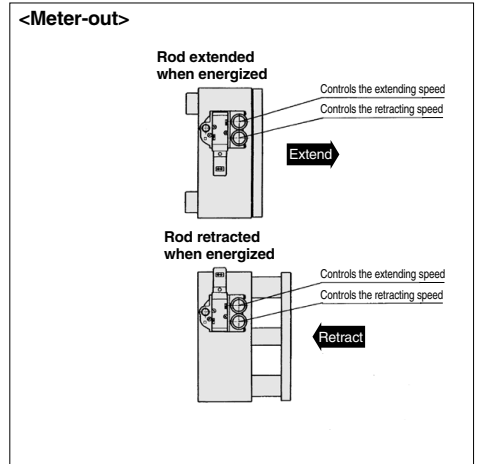
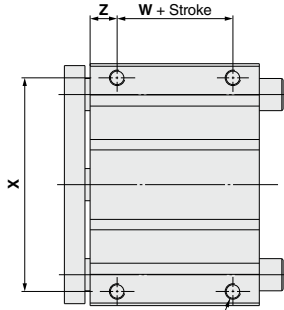

Fig. (3)



ø80, ø100

MVGQM, MVGQL



Bottom view

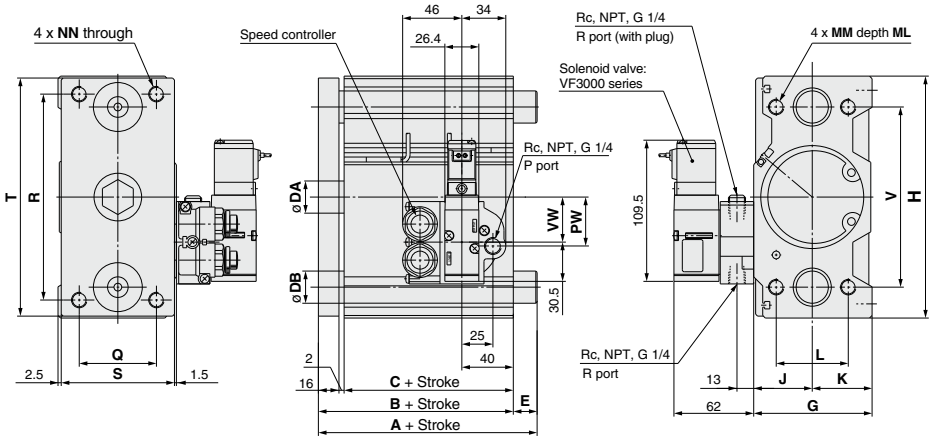

* The figures show when attached to VF3140-□G.

MVGQM, MVGQL Common Dimensions

Bore size (mm)	Standard stroke (mm)	Applicable solenoid valve	B	CA	DA	G	GA	H	J	K	L	MM	ML	NN	VWP	Q	R	S	T	V	W	X	YY	YL	Z	
80	25, 50, 75, 100, 125, 150, 175, 200	VF3000 series	74.5	56.5	25	92	40	188	45.5	46.5	56	M12x1.75	30	M12 x 1.75	35	38	60	160	88	185	140	15	166	M12 x 1.75	18	21
100			84	66	30	112	40	224	55.5	56.5	62	M14x2	35	M14 x 2	41	44	80	190	108	221	170	15	200	M14 x 2	21	25

Note 1) It is possible to manufacture the intermediate strokes other than the standard strokes by means of installing a spacer.

Note 2) For the electrical entry except the grommet type, refer to page 862.

MVGQM (Slide bearing) A, DB, E Dimensions

Bore size (mm)	Symbol	A		
		A	DB	E
80		93	28	18.5
100		105	36	21

MVGQL (Ball bushing bearing) A, DB, E Dimensions

Bore size (mm)	Symbol	A		DB	
		Up to 50 st	Over 50 st	Up to 50 st	Over 50 st
80		84	143	25	68.5
100		89	153	30	69

CVQ

CVQM

CVJ

CVM

CV3

CVS1

MVGQ

D-

-X

MVGQ Series

Construction

MVGQM series

MVGQM12 to 25

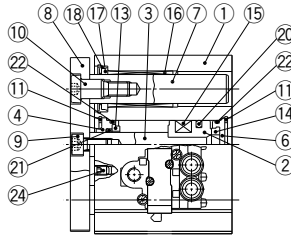

50 stroke or less

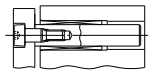

ø12, ø16

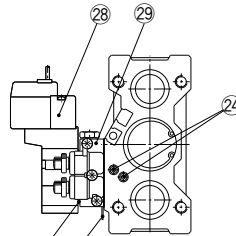

ø20, ø25 Over 50 stroke

MVGQM32 to 100

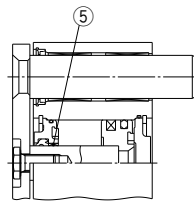
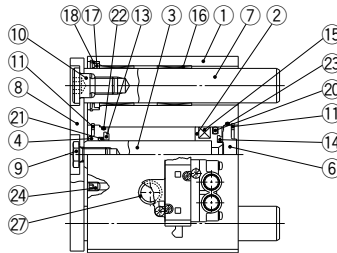

ø50 or more

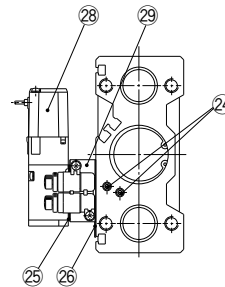

Component Parts

No.	Description	Material	Note
1	Body	Aluminum alloy	Hard anodized
2	Piston	Aluminum alloy	
3	Piston rod	Stainless steel	ø12 to ø25
		Carbon steel	ø32 to ø100 Hard chrome plated
4	Collar	Aluminum alloy	ø12 to ø40 White anodized
		Bearing alloy	ø50 to ø100 Painted
5	Bushing	Special friction material	ø50 to ø100
6	Head cover	Aluminum alloy	ø12 to ø63 Chromated
			ø80 to ø100 Painted
7	Guide rod	Carbon steel	Hard chrome plated
8	Plate	Carbon steel	Nickel plated
9	Plate mounting bolt	Carbon steel	Nickel plated
10	Guide bolt	Carbon steel	Nickel plated
11	Retaining ring	Carbon tool steel	Phosphate coated
12	Retaining ring	Carbon tool steel	Phosphate coated

No.	Description	Material	Note
13	Bumper A	Urethane	
14	Bumper B	Urethane	
15	Magnet	-	
16	Slide Bearing	Bearing alloy	
17	Felt	Felt	
18	Holder	Resin	
19	Ball bushing		
20	Piston seal	NBR	
21	Rod seal	NBR	
22	Gasket A	NBR	
23	Gasket B	NBR	
24	Hexagon socket head cap screw	Carbon steel	Nickel plated
25	Manifold gasket		
26	Selector plate		ø12 to ø63 only
27	Adapter gasket		ø25 to ø100 only
28	Solenoid valve		
29	Adapter assembly		

MVGQL series

MVGQL12 to 25

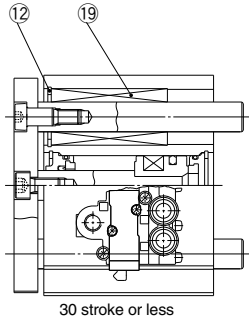

30 stroke or less



ø12, ø16: Over 30 stroke

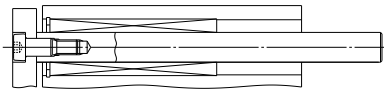

ø20, ø25: Over 30 stroke

MVGQL32 to 100

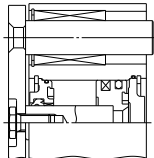
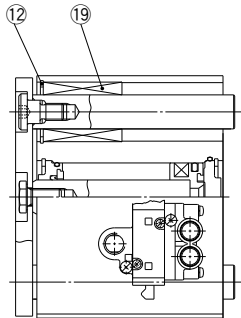

50 stroke or more

Replacement Parts

No.	Description	Kit no.									
		ø12	ø16	ø20	ø25	ø32	ø40	ø50	ø63	ø80	ø100
20 to 23	Seal kit	MGQ12-PS	MGQ16-PS	MGQ20-PS	MGQ25-PS	MGQ32-PS	MGQ40-PS	MGQ50-PS	MGQ63-PS	MGQ80-PS	MGQ100-PS
25 to 29	Solenoid valve with adapter assembly	SYJ3□3□□-□□□□-MA [▲]		VZ3□4□-□□□□-M□			VZ5□4□-□□□□-M□		VF3□4□-□□□□-M□		

Note 1) Seal kit includes 20 to 23. Order the seal kit, based on each bore size.

Note 2) For the specifying way of ordering numbers for the solenoid valve with adapter assembly, refer to pages 852, 856 and 862.

* Since the seal kit does not include a grease pack, order it separately.

Grease pack part no.: GR-S-010 (10 g)

Port thread type

Nil	Rc
N	NPT
F	G

CVQ

CVQM

CVJ

CVM

CV3

CVS1

MVGQ

D-

-X

Auto Switch Mounting

Auto Switch Proper Mounting Position (Detection at Stroke End)

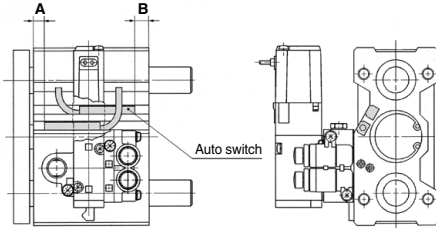

Auto Switch Proper Mounting Position (mm)

Auto switch model	D-M9□ D-M9□V D-M9□W D-M9□WV D-M9□A D-M9□AV		D-A9□ D-A9□V		D-Z7□/Z80 D-Y59□/Y7P D-Y69□/Y7PV D-Y7□W D-Y7□WV	
	A	B	A	B	A	B
12	6	8	2	4	1	3
16	9	9	5	5	4	4
20	9.5	12.5	5.5	8.5	4.5	7.5
25	9.5	13	5.5	9	4.5	8
32	10.5	12	6.5	8	5.5	7
40	14.5	14.5	10.5	10.5	9.5	9.5
50	12.5	16.5	8.5	12.5	7.5	11.5
63	15	19	11	15	10	14
80	18	23.5	14	19.5	13	18.5
100	22.5	28.5	18.5	24.5	17.5	23.5

Note) Adjust the auto switch after confirming the operating conditions in the actual setting.

Minimum Stroke for Auto Switch Mounting

Auto switch model	No. of auto switches mounted	ø12	ø16	ø20	ø25	ø32	ø40	ø50	ø63	ø80	ø100
D-A9□	1 pc.	5 Note 1)		5							
	2 pcs.	10 Note 1)		10							
D-A9□V D-M9□V	1 pc.	5									
	2 pcs.	10									
D-M9□	1 pc.	5 Note 1)							5		
	2 pcs.	10 Note 1)			10						
D-M9□W	1 pc.	5 Note 2)									
	2 pcs.	10 Note 2)			10						
D-M9□WV D-M9□AV	1 pc.	5 Note 2)									
	2 pcs.	10									
D-M9□A	1 pc.	5 Note 2)									
	2 pcs.	10 Note 2)									
D-Z7□ D-Z80 D-Y59□ D-Y7P	1 pc.	5 Note 1)							5		
	2 pcs.	10 Note 1)		10							
D-Y69□ D-Y7PV	1 pc.	5									
	2 pcs.	5									
D-Y7□W D-Y7□WV	1 pc.	5 Note 2)									
	2 pcs.	10 Note 2)									

Note 1) Confirm that it is possible to secure the minimum bending radius of 10 mm of the auto switch lead wire before use.

Note 2) Confirm that it is possible to securely set the auto switch(es) within the range of indicator green light ON range before use.

For in-line entry type, please also consider Note 1) shown above.

Operating Range

Auto switch model	Bore size (mm)									
	12	16	20	25	32	40	50	63	80	100
D-A9□/A9□V	7	9.5	9	9	9	9	9	10.5	10	10.5
D-M9□/M9□V D-M9□W/M9□WV D-M9□A/M9□AV	4	5.5	5	5	5.5	5	5.5	5.5	6.5	7
D-Z7□/Z80□	7.5	8.5	9.5	9.5	11	11	11	13	13	14
D-Y59□/Y69□ D-Y7P/Y7PV D-Y7□W/Y7□WV	5	6	6	6.5	8.5	8.5	9	10	10	11.5

* Since this is a guideline including hysteresis, not meant to be guaranteed. (Assuming approximately ±30% dispersion)

There may be the case it will vary substantially depending on an ambient environment.

Auto Switch Mounting Bracket: Part No.

Auto switch model	Bore size (mm)
D-A9□/A9□V D-M9□/M9□V D-M9□W/M9□WV D-M9□A/M9□AV	BMG2-012

• D-A9□(V), M9□(V), M9□W(V), M9□A(V)

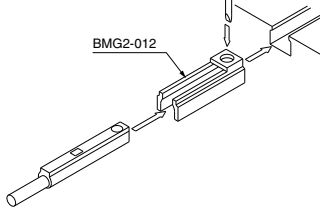

Other than the models listed in "How to Order", the following auto switches are applicable.
For detailed specifications, refer to pages 941 to 1067.

Auto switch type	Model	Electrical entry (Fetching direction)	Features
Reed	D-Z73, Z76	Grommet (In-line)	—
	D-Z80		Without indicator light
Solid state	D-Y69A, Y69B, Y7PV	Grommet (Perpendicular)	—
	D-Y7NWV, Y7PWV, Y7BWV		Diagnostic indication (2-color)
	D-Y59A, Y59B, Y7P	Grommet (In-line)	—
	D-Y7NW, Y7PW, Y7BW		Diagnostic indication (2-color)

* For solid state auto switches, auto switches with a pre-wired connector are also available. Refer to pages 1014 and 1015 for details.
* Normally closed (NC = b contact) solid state auto switches (D-M9□E(V)/Y7G/Y7H) are also available. For details, refer to pages 1592-1 and 961.

CVQ

CVQM

CVJ□

CVM□

CV3

CVS1

MVGQ

D-□

-X□



MVGQ Series Precautions 1

Be sure to read this before handling the products.

Selection

⚠ Warning

1. Confirm the specifications.

Products in this catalog are designed to be used for compressed air systems (including vacuum). If not operated within the designated pressure or temperature, it may damage the products or cause malfunction. (Refer to specifications.)

2. Energizing continuously for a long period of time.

When the valve is continuously energized for a long period of time, the performance may deteriorate, shorten the service life or effect peripheral equipment adversely since temperature rises when coils generate heat. Use the DC specification and energy saving circuit types when the valve is energized for a long period of time or energizing time becomes longer than non-energizing time during a day. Another way will be to make the valve N.O. (Normally Open), which shortens energizing time.

Manual Operation

⚠ Warning

Since the devices in connection are operated by manual override, make sure that there is no danger.

■ Non-locking push type [Standard type]

Push in the direction of the arrow.



■ Push-turn locking slotted type [D type]

Push and turn in the direction of the arrow.

If this is not turned, it can be used in the same way as the non-locking push type.



The position when locked



⚠ Caution

When operating D type with the driver, use a watchmaker's screwdriver and turn it lightly. [Torque: Less than 0.1 N·m]

■ Push-turn locking lever type [E type]

Push and turn in the direction of the arrow.

If this is not turned, it can be used in the same way as the non-locking push type.



The position when locked



⚠ Caution

When locking the manual override with the push-turn locking type (D and E types), be sure to push it down before turning. Turning without first pushing it down can cause damage to the manual override and malfunction such as air leakage, etc.

Plug Connector

⚠ Caution

1. Connector installation and removal

- To install the connector, squeeze the lever and the connector body with your fingers, slide the connector straight over the pin, and lock it in place by pushing the tab of the lever into the groove in the cover.
- To remove the connector, press the lever with your thumb to disengage the tab from the groove, and pull the connector straight out.

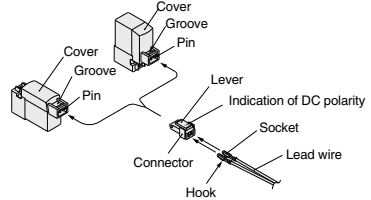

2. Crimping the lead wire into the socket

Peel approximately 3.2 to 3.7 mm of insulation from the tip of the lead wire, make sure that the ends of the core wire are even, insert the wire into the socket, and crimp it with a crimping tool. At this time, make sure that the insulation of the lead wire does not enter the area in which the core wire is crimped. (Please contact SMC for details on the special crimping tool.)

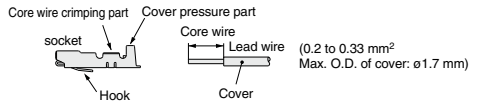

3. Attaching and detaching lead wires with sockets

● Attaching

Insert the sockets into the square holes of the connector (with ⊕ and ⊖ indication), continue to push the sockets all the way in until the lock by hooking into the seats in the connector. (When they are pushed in, their hooks open and they are locked automatically.) Then confirm that they are locked by pulling lightly on the lead wires.

● Detaching

To detach a socket from a connector, pull out the lead wire while pressing the socket's hook with a stick having a thin tip (approx. 1 mm). If the socket is re-used as it is, spread the hook to the outside.

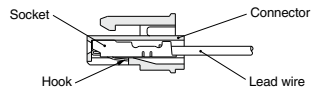



MVGQ Series Precautions 2

Be sure to read this before handling the products.

Surge Voltage Suppressor

⚠ Caution

< For DC >

Grommet, L/M plug connector

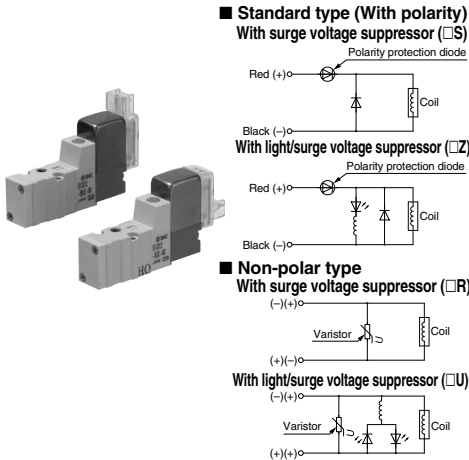

- Connect the wires by matching their polarities to the + and - marks. (Non-polar type can be connected to either of them.)
- Since the electrical voltage other than 24 VDC, 12 VDC have no feature of polarity protection diode, use caution not to make a mistake of the polarity.
- Valves with diode to prevent reverse current have a voltage drop of approximately 1 V. Be aware of the allowable voltage fluctuation. (Refer to solenoid specifications of each valve for details.)
- If the lead wires are connected beforehand, the red wire is +, and the black wire is -.

■ With energy saving circuit

By reducing electric power required in the holding state, power consumption is reduced to about 1/4 of the standard type. (Effective energizing time is over 62 ms when 24 VDC is applied.)

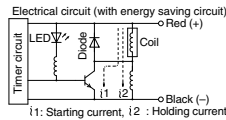

Working Principle

The circuit shown above reduces current consumption at holding, which reduces the overall power consumption. Refer to the electrical power waveform shown on the right.

- Since the product with an energy-saving circuit does not have a diode to prevent reverse current, avoid mistaking polarity.
- Be aware of the allowable voltage fluctuation, since there is about 0.5 voltage drop due to a transistor. (Refer to solenoid specifications of each valve for details.)

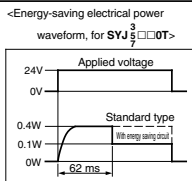

M8 connector

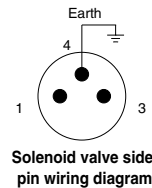
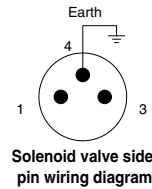

■ Standard type (With polarity)

With surge voltage suppressor (□S)

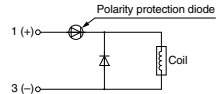

■ With light/surge voltage suppressor (□U)

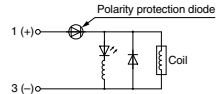

■ Non-polar type

With surge voltage suppressor (□R)

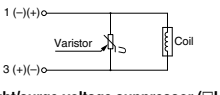

■ With light/surge voltage suppressor (□U)

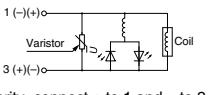

- Since the standard type has polarity, connect + to 1 and - to 3.
- Since the electrical voltage other than 24 VDC, 12 VDC have no feature of polarity protection diode, use caution not to make a mistake of the polarity.
- Valves with diode to prevent reverse current have a voltage drop of approximately 1 V. Be aware of the allowable voltage fluctuation. (Refer to solenoid specifications of each valve for details.)

Surge Voltage Suppressor

< For AC >

(Since the rectifier prevents the production of surge voltage, there is no S type.)

Grommet, L/M plug connector

With indicator light (□Z)

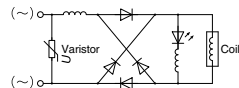

CVQ

CVQM

CVJ □

CVM □

CV3

CVS1

MVGQ

D-□

X□



MVGQ Series Precautions 3

Be sure to read this before handling the products.

M8 Connector

⚠ Caution

1. M8 connectors compliant with IP65 (enclosure) are protected against dust and water, however, they cannot be used in water.

Use SMC's lead wire assembly (V100-49-1-□) or a connector for FA sensor (M8 thread 3 pin type) conforming to NECA (Nippon Electric Control Equipment Industries Association) standard 4202 (IEC60947-5-2) for the connectors used. When the connectors are used with SYJ3000 manifolds, use the connectors with O.D. 10.5 mm or smaller. If the connectors have O.D. 10.5 mm or greater, they cannot be connected since they interfere with manifolds.

2. When installing connectors, be sure to tighten them by hand since using tools may damage them. (0.4 to 0.6 N·m)

3. Do not apply a force of 30N or more since it may not meet IP65.

⚠ Caution

When using connectors other than M8 or not tightening them sufficiently, IP65 cannot be met.

- How to mount connectors with a lead wire

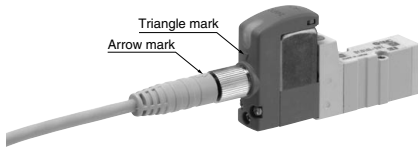

Note) When installing a connector cable, directions must be confirmed. When installing SMC's connector cable (V100-49-1-□), align the arrow mark of the connector and the triangle mark of the valve.

Twisting without alignment may damage pins and cause malfunction.

■ Connector Cable

- Refer to how to order the connector cable for M8 shown below.

How to order

1. When ordering the solenoid valve and the connector cable at the same time (Connector cable is shipped together.)

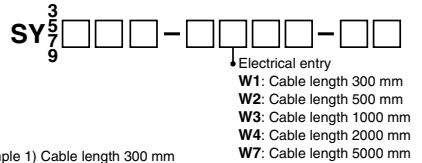

(Example 1) Cable length 300 mm

SY312-5W1ZE-C4

↳ Cable entry symbol

2. When ordering a connector cable only

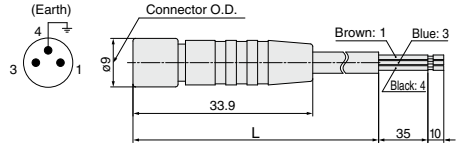

Cable length (L)	Model
300 mm	V100-49-1-1
500 mm	V100-49-1-2
1000 mm	V100-49-1-3
2000 mm	V100-49-1-4
5000 mm	V100-49-1-7

[Dimensions when installed]

