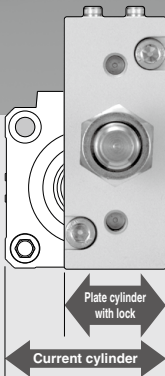
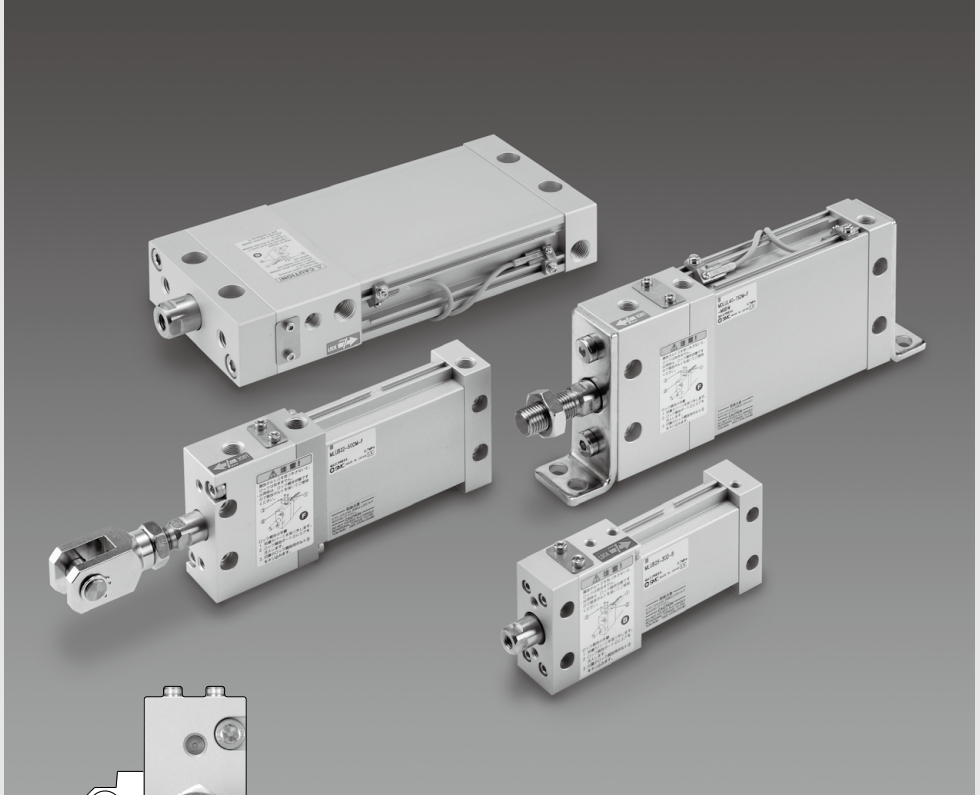

Plate Cylinder with Lock

MLU Series

ø25, ø32, ø40, ø50



Ideal for maintaining supply pressure to prevent dropping of the load when residual pressure is released.

- CLJ2
- CLM2
- CLG1
- CL1
- MLGC
- CNG
- MNB
- CNA2
- CNS
- CLS
- CLQ
- RLQ
- MLU**
- MLGP
- ML1C

- D-□
- X□

Plate Cylinder with Lock

MLU Series

ø25, ø32, ø40, ø50



Drop prevention is possible at any point of stroke.

- Drop prevention for middle stroke emergency stops
- Lock positions can be changed to accommodate the position of the external stopper and the thickness of the clamped workpiece.

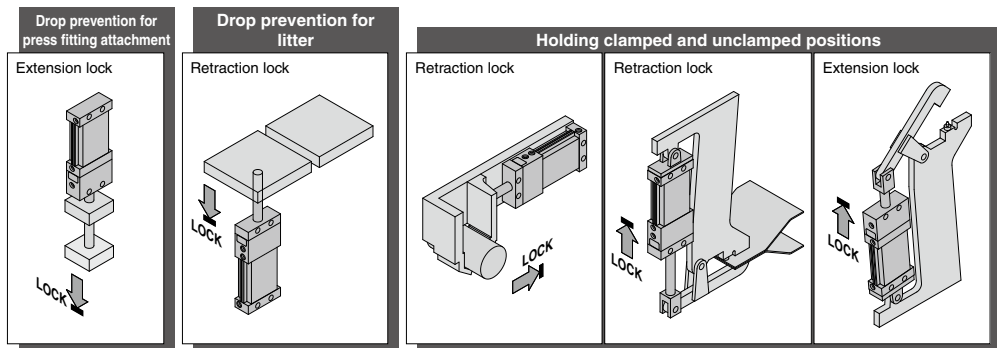

Simple construction: Simple and reliable locking system

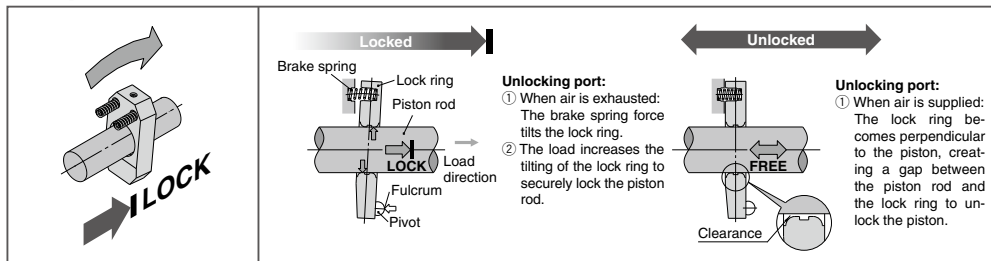

Slim and compact lock unit

- Lock unit length

35 mm to 50.5 mm

- Lock unit width

24 mm to 39 mm

The compact lock unit does not protrude beyond the cylinder body surface.

Lock unit thickness (mm)

Bore size (mm)	A	B
25	24	35
32	28	42
40	32	44
50	39	50.5

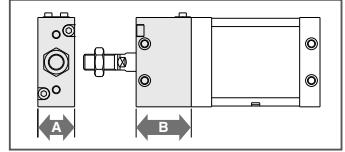

Easy manual unlocking

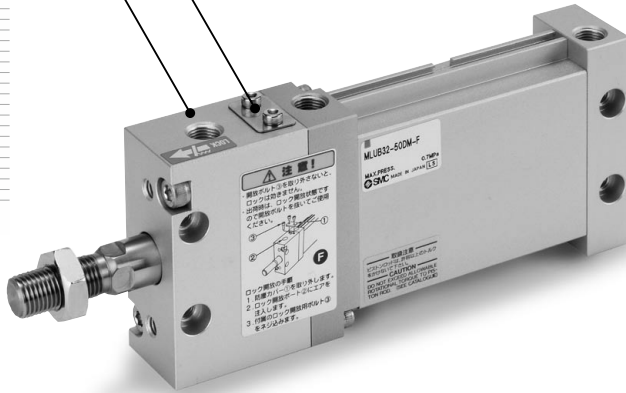
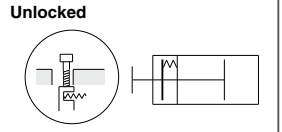
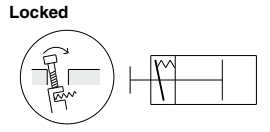
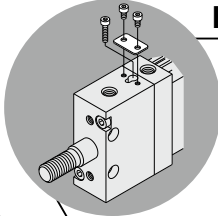

Locking direction can be selected.

Extension lock

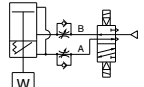

Retraction lock

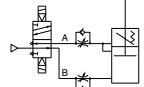

* The symbol for the cylinder with lock in the pneumatic circuit uses SMC original symbol.

Various mounting brackets to accommodate wide range of applications.

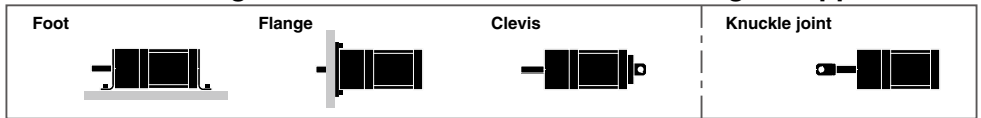

Flexible mounting: Possible to mount on all surfaces except for the one with ports

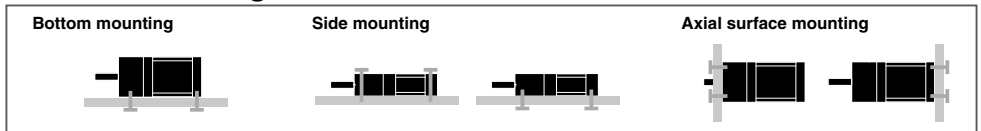

Series Variations

Series	Locking direction	Bore size (mm)	Standard stroke (mm)																	
			5	10	15	20	25	30	35	40	45	50	75	100	125	150	175	200	250	300
MLU	Extension lock	25	●	●	●	●	●	●	●	●	●	●	●	●	●	●	●	●	●	●
		32	●	●	●	●	●	●	●	●	●	●	●	●	●	●	●	●	●	●
	Retraction lock	40	●	●	●	●	●	●	●	●	●	●	●	●	●	●	●	●	●	●
		50	●	●	●	●	●	●	●	●	●	●	●	●	●	●	●	●	●	●

CLJ2

CLM2

CLG1

CL1

MLGC

CNG

MNB

CNA2

CNS

CLS

CLQ

RLQ

MLU

MLGP

ML1C

D-□

-X□

Plate Cylinder with Lock

MLU Series

ø25, ø32, ø40, ø50

How to Order

MLU B 25 - 30 D - F -

With auto switch MDLU B 25 - 30 D - F - M9BW S -

With auto switch (Built-in magnet)

Mounting Type

B	Basic type
L	Axial foot type
F	Rod flange type
G	Head flange type
C	Single clevis type
D	Double clevis type

* Mounting brackets are shipped together (not assembled).

Size

25	Pressure receiving area equivalent to that of ø25 type
32	Pressure receiving area equivalent to that of ø32 type
40	Pressure receiving area equivalent to that of ø40 type
50	Pressure receiving area equivalent to that of ø50 type

Port thread type

Nil	M thread	ø25
	Rc	
TN	NPT	ø32, ø40, ø50
TF	G	

Cylinder stroke (mm)

Refer to "Standard Stroke" on page 1061.

Number of auto switches

Nil	2 pcs.
S	1 pc.
n	"n" pcs.

Auto switch

Nil	Without auto switch
-----	---------------------

* For the applicable auto switch model, refer to the table below.

Locking direction

F	Extension locking
B	Retraction locking

Made to Order

For details, refer to page 1061.

Rod end shape

Nil	Rod end female thread
M	Rod end male thread

Action

D	Double acting
---	---------------

Built-in Magnet Cylinder Model

If a built-in magnet cylinder without an auto switch is required, there is no need to enter the symbol for the auto switch.
(Example) MDLU32-30D-B

Applicable Auto Switches

Refer to pages 1119 to 1245 for further information on auto switches.

Type	Special function	Electrical entry direction	Indicator light	Wiring (output)	Load voltage		Auto switch model		Lead-wire length (m)					Pre-wired connector	Applicable load		
					DC	AC	Perpendicular	In-line	0.5 (Nil)	1 (M)	3 (L)	5 (Z)	None (N)				
Solid state auto switch	—	Grommet	No	3-wire (NPN)	5 V, 12 V	—	M9NV	M9N	●	●	○	—	○	IC circuit	Relay, PLC		
				3-wire (PNP)			M9PV	M9P	●	●	○	—	○				
	Diagnostic indication (2-color indicator)	Connector	Yes	2-wire	12 V	—	M9BV	M9B	●	●	○	—	○	—			
				3-wire (NPN)	5 V, 12 V	M9NV	M9NW	●	●	○	—	○	IC circuit				
	Water resistant (2-color indicator)	Grommet	Yes	3-wire (PNP)	12 V	—	M9PV	M9PW	●	●	○	—	○	—			
				2-wire	24 V	—	M9BV	M9B	●	●	○	—	○	—			
	With diagnostic output (2-color indicator)	Grommet	Yes	3-wire (NPN)	5 V, 12 V	—	M9NAV**	M9NA**	○	○	○	○	○	IC circuit			
				3-wire (PNP)	5 V, 12 V	—	M9PAV**	M9PA**	○	○	○	○	○	—			
				2-wire	12 V	—	M9BAV**	M9BA**	○	○	○	○	○	—			
				4-wire (NPN)	5 V, 12 V	—	—	F79F	●	—	●	—	—	○		IC circuit	
Magnetic field resistant (2-color indicator)	Grommet	Yes	2-wire (Non-polar)	—	—	—	P3DWA	●	—	●	—	—	○	—			
			—	—	—	P4DW	—	—	●	●	—	—	—				
Reed auto switch	—	Grommet	Yes	3-wire (NPN equiv.)	24 V	12 V	—	A76H	●	—	●	—	—	—	IC circuit	Relay, PLC	
							—	200 V	A72	A72H	●	—	●	—	—		—
							—	100 V	A73	A73H	●	—	●	—	—		—
		Connector	No	2-wire	100 V or less	A80	A80H	●	—	●	—	—	—	IC circuit			
					—	—	A73C	—	●	—	●	●	—	—	—		
		Grommet	Yes	—	—	—	—	A80C	—	●	—	●	●	—	—		IC circuit
					—	—	A79W	—	●	—	●	—	—	—	—		

** Water resistant type auto switches can be mounted on the above models, but in such case SMC cannot guarantee water resistance. Consult with SMC regarding water resistant types with the above model numbers.

- * Lead wire length symbols: 0.5 m Nil (Example) M9NW
 1 m M (Example) M9NWM
 3 m L (Example) M9NWL
 5 m Z (Example) M9NWZ
 None N (Example) J79CN
- * Solid state auto switches marked with a "○" are produced upon receipt of order.
 * D-A9□/A9□□ cannot be mounted.
 * D-P4DW type can only be mounted on the types for tubing of ø40 and ø50.
 Only D-P4DW is mounted when shipped.

* Besides the models in the above table, there are some other auto switches that are applicable. For more information, refer to page 1070.
 * Refer to pages 1192 and 1193 for the details of auto switches with a pre-wired connector.

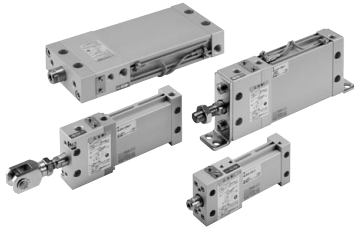

Cylinder Specifications

Size	25	32	40	50
Action	Double acting, Single rod			
Fluid	Air			
Proof pressure	1.05 MPa			
Maximum operating pressure	0.7 MPa			
Minimum operating pressure	0.2 MPa <small>Note)</small>			
Ambient and fluid temperature	-10 to 60°C (with no freezing)			
Lubrication	Not required (Non-lube)			
Cushion	Rubber bumper (Standard)			
Stroke length tolerance	+1.4 0			
Piston speed	50 to 500 mm/s			
Cylinder port size (Rc, NPT, G)	M5 x 0.8	1/8		1/4

Note) The minimum operating pressure of the cylinder is 0.1 MPa when the cylinder and lock are connected to separate ports.

Lock Specifications

Size	25	32	40	50
Locking action	Spring locking (Exhaust locking)			
Unlocking pressure	0.2 MPa or more			
Locking pressure	0.05 MPa or less			
Locking direction	One direction (Either extension locking or retraction locking)			
Maximum operating pressure	0.7 MPa			
Unlocking port connection size (Rc, NPT, G)	M5 x 0.8		1/8	
Holding force N (maximum static load) <small>Note)</small>	245	403	629	982

Note) The holding force (max. static load) shows the maximum capability and does not show the normal holding capability. So, select an appropriate cylinder while referring to page 1071.

Non-rotating Rod Accuracy

Size	25	32	40	50
Non-rotating rod accuracy	±1°	±0.8°		±0.5°

Standard Stroke

Size	Standard stroke (mm)	Max. manufacturable stroke
25, 32, 40, 50	5, 10, 15, 20, 25, 30, 35, 40, 45, 50 75, 100, 125, 150, 175, 200, 250, 300	300

* Strokes other than listed above will be produced upon request of order. Please consult with SMC.
** Strokes longer than 300 mm are not available.

Weight

Unit: kg

	Size	25	32	40	50
Basic weight	Basic type	0.34	0.58	0.87	1.52
	Axial foot type	0.41	0.72	1.08	1.86
	Flange type: Rod/Head	0.44	0.72	1.10	1.98
	Single clevis type	0.40	0.70	1.09	1.92
	Double clevis type (with pin)	0.41	0.74	1.13	1.99
Additional weight per each 50 mm of stroke		0.12	0.16	0.22	0.34
Attached metal weight	Single clevis type (Double clevis bracket)	0.06	0.12	0.22	0.40
	Double clevis type (Single clevis bracket)	0.07	0.16	0.26	0.47
	Single knuckle joint	0.03	0.04	0.07	0.16
	Double knuckle joint (with pin)	0.05	0.09	0.14	0.29

Note) The weight of the attached metal single clevis and double clevis include the weight of two pieces of mounting bolts.

Calculation method—Example: **MDLUL32-100D-F**

- Basic weight 0.72 (axial foot type · size 32)
- Additional weight 0.16/50 stroke
- Stroke 100 stroke

$$0.72 + 100/50 \times 0.16 = 1.04 \text{ kg}$$



Made to Order

[Click here for details](#)

Symbol	Specifications
-XC87	Heavy duty (ø40 and ø50 only)

Refer to pages 1068 to 1070 for cylinders with auto switches.

- Minimum auto switch mounting stroke
- Proper auto switch mounting position (detection at stroke end) and mounting height
- Operating range
- Switch mounting bracket: Part no.

CLJ2

CLM2

CLG1

CL1

MLGC

CNG

MNB

CNA2

CNS

CLS

CLQ

RLQ

MLU

MLGP

ML1C

D-□

-X□

MLU Series

Theoretical Output

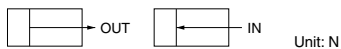

Size	Rod size (mm)	Operating direction	Piston area (mm ²)	Operating pressure (MPa)					
				0.2	0.3	0.4	0.5	0.6	0.7
25	12	OUT	491	98	147	196	246	295	344
		IN	378	76	113	151	189	227	265
32	14	OUT	804	161	241	322	402	482	563
		IN	650	130	195	260	325	390	455
40	16	OUT	1257	251	377	503	629	754	880
		IN	1056	211	317	422	528	634	739
50	20	OUT	1963	393	589	785	982	1178	1374
		IN	1649	330	495	660	824	989	1154

Note) Theoretical output (N) = Pressure (MPa) x Piston area (mm²)

Mounting Bracket Part No.

Bracket \ Size	25	32	40	50
Foot Note 1)	MU-L02	MU-L03	MU-L04	MU-L05
Flange	MU-F02	MU-F03	MU-F04	MU-F05
Single clevis	MU-C02	MU-C03	MU-C04	MU-C05
Double clevis	MU-D02	MU-D03	MU-D04	MU-D05

Note 1) When ordering foot brackets, order 2 pieces for each cylinder.

Note 2) The parts included with each bracket are shown below.

Foot, Flange, Single clevis/Body mounting bolt

Double clevis/Pins for clevis, Type C retaining ring for axis, Body mounting

Construction

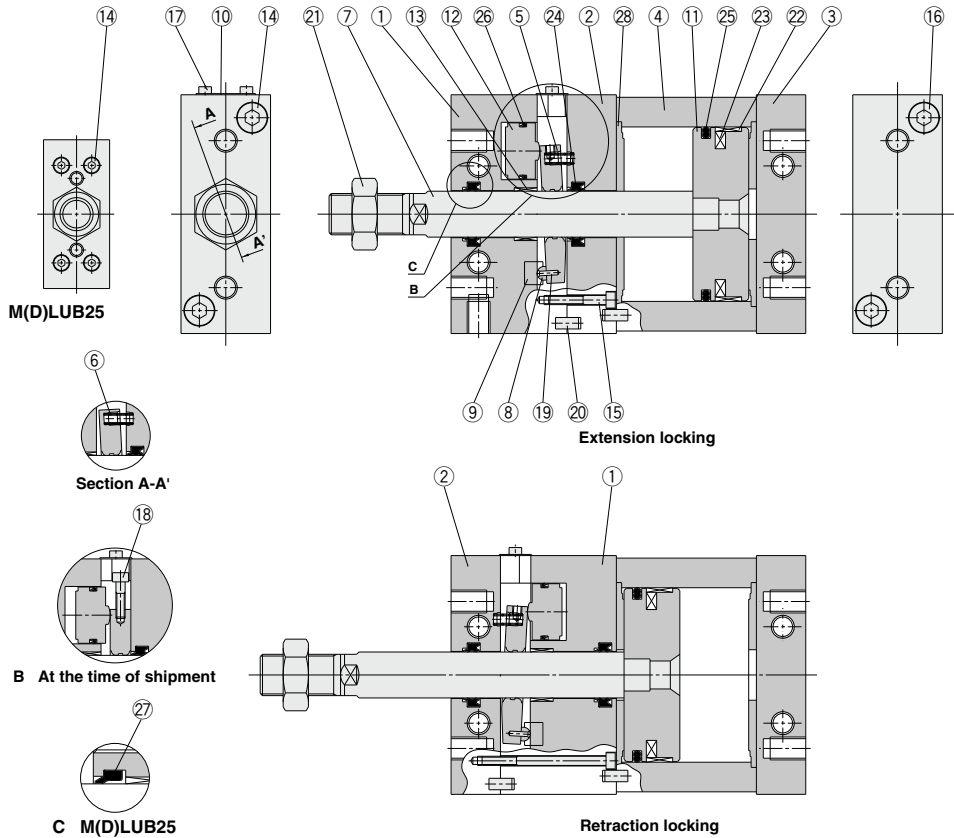

CLJ2
CLM2
CLG1
CL1
MLGC
CNG
MNB
CNA2
CNS
CLS
CLQ
RLQ
MLU
MLGP
ML1C

Component Parts

No.	Description	Material	Note
1	Lock body	Aluminium alloy	Hard anodized
2	Cover	Aluminium alloy	Hard anodized
3	Head cover	Aluminium alloy	Hard anodized
4	Cylinder tube	Aluminium alloy	Hard anodized
5	Lock ring	Carbon steel	Heat treatment
6	Brake spring	Steel wire	Zinc chromated
7	Piston rod	Carbon steel	Hard chromium electro plating
8	Pivot	Carbon steel	Heat treatment, zinc chromated
9	Pivot key	Carbon steel	Heat treatment, zinc chromated
10	Dust proof cover	Stainless steel	
11	Piston	Aluminium alloy	Chromate
12	Release piston	Special steel	Heat treatment
13	Bushing	Bearing alloy	
14	Hexagon socket head cap screw A	Stainless steel	

No.	Description	Material	Note
15	Hexagon socket head cap screw B	Stainless steel	
16	Hexagon socket head cap screw C	Stainless steel	
17	Hexagon socket head cap screw D	Chrome molybdenum steel	
18	Hexagon socket head cap screw E	Chrome molybdenum steel	
19	Spring pin	Carbon steel	
20	Parallel pin	Stainless steel	
21	Rod end nut	Rolling steel	Only for use with rod end male thread
22	Wear ring	Resin	
23	Magnet	—	Only for use with built-in magnet type
24	Rod seal	NBR	Use one piece with M(D)LUB25 Use 2 pieces with M(D)LUB32 to 50
25	Piston seal	NBR	
26	Release piston seal	NBR	
27	Scraper	NBR	Only for use with M(D)LUB25
28	Bumper	Urethane rubber	

<input type="checkbox"/> D
<input type="checkbox"/> -X

Dimensions

Basic type

M(D)LUB25, 32

Retraction locking

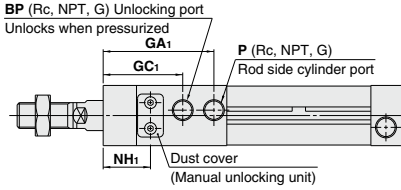

M(D)LUB40, 50

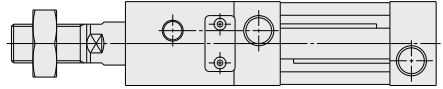

Extension locking

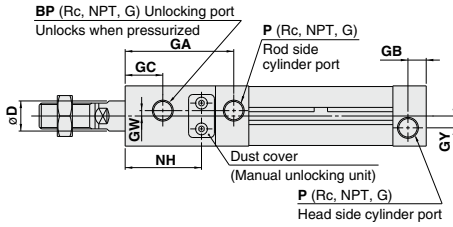

Rod end female thread

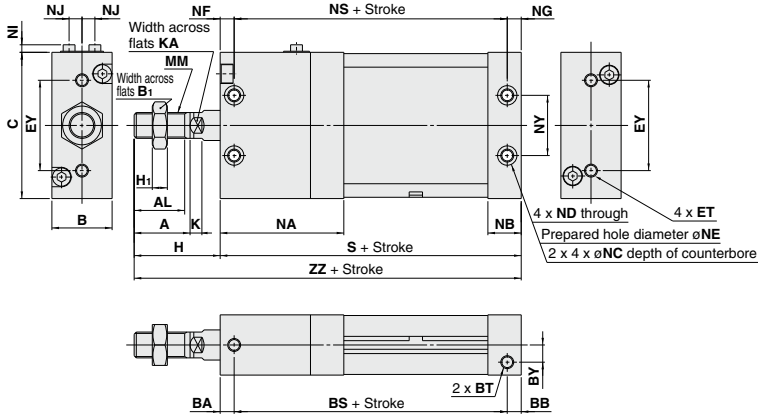
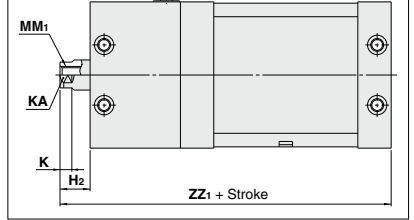

(mm)

Model	Stroke range	A	AL	B	B1	BA	BB	BP	BS	BT	BY	C	D	ET	EY	GA	GA1	GB	GC	GC1	GW	GY	H	H1
MLUB25	5 to 300	22	19.5	24	17	8	9	M5 x 0.8	73	M5 x 0.8 depth 7.5	7	54	12	M5 x 0.8 depth 11	26	45	45	10	15.5	32.5	2.5	5	36	6
MLUB32	5 to 300	26	23.5	28	19	6.5	6.5	1/8	87	M6 x 1 depth 12	8	68	14	M6 x 1 depth 11	42	50.5	51.5	8.5	17.5	37	0	5.5	40	7
MLUB40	5 to 300	30	27	32	22	9	8	1/8	87	M8 x 1.25 depth 13	9	86	16	M8 x 1.25 depth 11	54	53	53	9	18.5	38.5	0	7	45	8
MLUB50	5 to 300	35	32	39	27	12	10	1/8	102.5	M10 x 1.5 depth 14.5	9	104	20	M10 x 1.5 depth 15	64	62	62	11.5	23	43	6	8	53	11

Model	H2	K	KA	MM	MM1	NA	NB	NC	ND	NE	NF	NG	NH	NH1	NI	Nj	NS	NY	P	S	ZZ	ZZ1
MLUB25	14	5.5	10	M10 x 1.25	M6 x 1 depth 12	49	14	7.5 depth 4.5	M5 x 0.8	4.3	8	6	30	19	3.5	6	76	26	M5 x 0.8	90	126	104
MLUB32	14	5.5	12	M12 x 1.25	M8 x 1.25 depth 13	57.5	15.5	9 depth 5.5	M6 x 1	5.1	6.5	6.5	35.5	22	3.5	6	87	28	1/8	100	140	114
MLUB40	15	6	14	M14 x 1.5	M8 x 1.25 depth 13	60	16	10.5 depth 6.5	M8 x 1.25	6.9	9	8	37.5	22.5	3.5	9	87	36	1/8	104	149	119
MLUB50	18	7	18	M18 x 1.5	M10 x 1.5 depth 15	72	21.5	13.5 depth 8.5	M10 x 1.5	8.7	12	10	44	28	3.5	9	102.5	42	1/4	124.5	177.5	142.5

Dimensions

Axial foot type

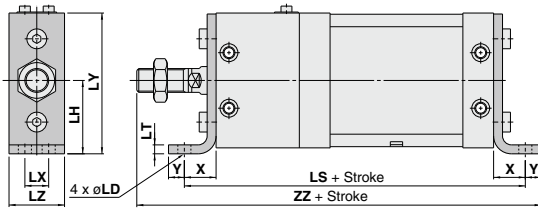

Model	LD	LH	LS	LT	LX	LY	LZ	X	Y	ZZ
MLUL25	5.5	29	114	3.2	11	56	23	12	6	144
MLUL32	6.6	37	132	4.5	12	71	27	16	8	164
MLUL40	9	46	140	4.5	15	89	31	18	10	177
MLUL50	11	57	166.5	5	18	109	37	21	11	209.5

Rod flange type

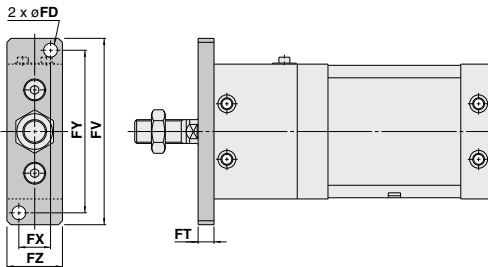

Model	FD	FT	FV	FX	FY	FZ	ZZ
MLUF25, MLUG25	5.5	8	76	14	66	24	134
MLUF32, MLUG32	7	8	94	16	82	28	148
MLUF40, MLUG40	9	9	118	18	102	32	158
MLUF50, MLUG50	11	12	144	22	126	39	189.5

Head flange type

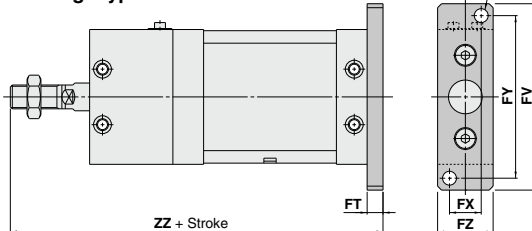

Single clevis type Double clevis type

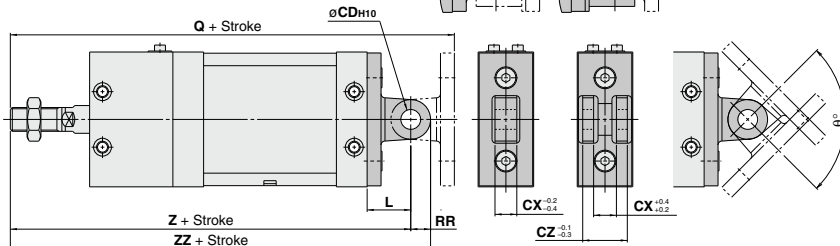

Single clevis type Double clevis type

Model	CDH10	CX	CZ	L	Q	RR	Z	ZZ	Rotation angle
MLUC25, MLUD25	8 ^{+0.058} ₀	9	18	17	160	8	143	151	100
MLUC32, MLUD32	10 ^{+0.058} ₀	11	22	22	184	10	162	172	90
MLUC40, MLUD40	10 ^{+0.058} ₀	13	26	27	203	10	176	186	80
MLUC50, MLUD50	14 ^{+0.070} ₀	16	32	32	241.5	14	209.5	223.5	80

* Clevis pins and retaining rings are included in the double clevis type.

- CLJ2
- CLM2
- CLG1
- CL1
- MLGC
- CNG
- MNB
- CNA2
- CNS
- CLS
- CLQ
- RLQ
- MLU
- MLGP
- ML1C

- D-□
- X□

MLU Series

Accessory Bracket Dimensions

Single Clevis (Double clevis bracket)

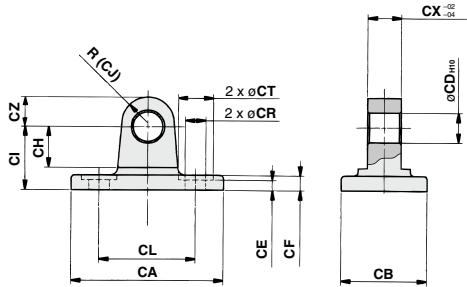

(mm)

Model	Size	CA	CB	CD _{H10}	CE	CF	CH	CI	CJ
MU-C02	25	53	23	8 ^{+0.058} ₀	3.5	4	11	17	7
MU-C03	32	67	27	10 ^{+0.058} ₀	3.5	7	13	22	10
MU-C04	40	85	31	10 ^{+0.058} ₀	3.5	10	13	27	10
MU-C05	50	103	37	14 ^{+0.070} ₀	5.5	12	17	32	14

Model	CL	CR	CT	CX	CZ
MU-C02	26	5.3	9.5	9	8
MU-C03	42	6.4	11	11	10
MU-C04	54	8.4	14	13	10
MU-C05	64	10.5	17	16	14

Double Clevis (Single clevis bracket)

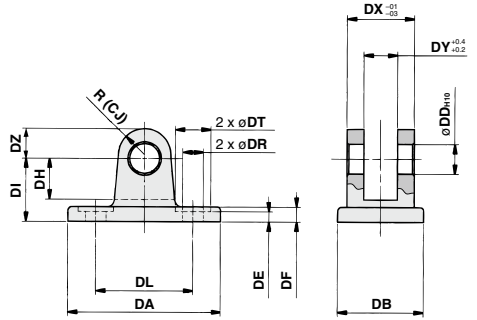

(mm)

Model	Size	DA	DB	DD _{H10}	DE	DF	DH	DI	DJ
MU-D02	25	53	23	8 ^{+0.058} ₀	3.5	4	11	17	7
MU-D03	32	67	27	10 ^{+0.058} ₀	3.5	7	13	22	10
MU-D04	40	85	31	10 ^{+0.058} ₀	3.5	10	13	27	10
MU-D05	50	103	37	14 ^{+0.070} ₀	5.5	12	17	32	14

Model	DL	DR	DT	DX	DY	DZ	Applicable pin no.
MU-D02	26	5.3	9.5	18	9	8	CD-MU02
MU-D03	42	6.4	11	22	11	10	CD-MU03
MU-D04	54	8.4	14	26	13	10	CD-MU04
MU-D05	64	10.5	17	32	16	14	CD-MU05

Clevis pins and retaining rings are included with the double clevis type.

Single Knuckle Joint

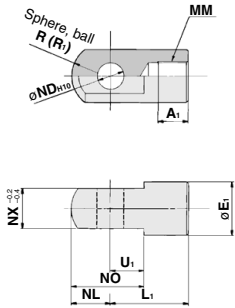

(mm)

Part no.	Size	A ₁	E ₁	L ₁	MM
I-MU02	25	10.5	16	27	M10 x 1.25
I-MU03	32	12	18	31	M12 x 1.25
I-MU04	40	14	20	36	M14 x 1.5
I-MU05	50	18	28	46	M18 x 1.5

Part no.	ND _{H10}	NL	NO	NX	R ₁	U ₁
I-MU02	8 ^{+0.058} ₋₀	8.5	19.5	9	8.5	11
I-MU03	10 ^{+0.058} ₋₀	10	24	11	10	14
I-MU04	10 ^{+0.058} ₋₀	11	26	13	11	15
I-MU05	14 ^{+0.070} ₋₀	16	36	16	16	20

Double Knuckle Joint

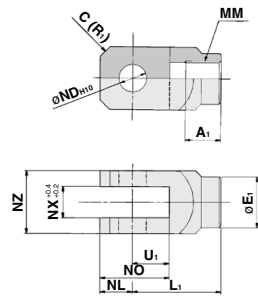

(mm)

Part no.	Size	A ₁	E ₁	L ₁	MM	ND _{H10}
Y-MU02	25	10.5	14	27	M10 x 1.25	8 ^{+0.058} ₋₀
Y-MU03	32	12	18	31	M12 x 1.25	10 ^{+0.058} ₋₀
Y-MU04	40	14	20	36	M14 x 1.5	10 ^{+0.058} ₋₀
Y-MU05	50	18	28	46	M18 x 1.5	14 ^{+0.070} ₋₀

Part no.	NL	NO	NX	NZ	R ₁	U ₁	Applicable pin no.
Y-MU02	8	21	9	18	3	13	CD-MU02
Y-MU03	10	24	11	22	4	14	CD-MU03
Y-MU04	10	27	13	26	5	17	CD-MU04
Y-MU05	16	39	16	32	6	23	CD-MU05

* Knuckle pin and retaining ring are included.

Clevis Pin and Knuckle Pin

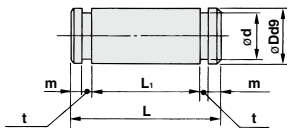

(mm)

Part no.	Size	Dd9	L	d	L ₁
CD-MU02	25	8 ^{+0.040} _{-0.076}	23	7.6	18.2
CD-MU03	32	10 ^{+0.040} _{-0.076}	27	9.6	22.2
CD-MU04	40	10 ^{+0.040} _{-0.076}	31	9.6	26.2
CD-MU05	50	14 ^{+0.050} _{-0.090}	38	13.4	32.2

Part no.	m	t	Retaining ring
CD-MU02	1.5	0.9	C8 type for pivot
CD-MU03	1.25	1.15	C10 type for pivot
CD-MU04	1.25	1.15	C10 type for pivot
CD-MU05	1.75	1.15	C14 type for pivot

* Included with the double clevis and double knuckle joint as standard.
* Retaining rings are included.

Rod End Nut

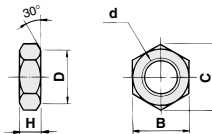

(mm)

Part no.	Size	d	H	B	C	D
NT-03	25	M10 x 1.25	6	17	19.6	16.5
NT-MU03	32	M12 x 1.25	7	19	21.9	18
NT-04	40	M14 x 1.5	8	22	25.4	21
NT-05	50	M18 x 1.5	11	27	31.2	26

* One piece is included with the rod end male thread as standard.

- CLJ2
- CLM2
- CLG1
- CL1
- MLGC
- CNG
- MNB
- CNA2
- CNS
- CLS
- CLQ
- RLQ
- MLU
- MLGP
- ML1C

- D-□
- X□

Auto Switch Mounting

Auto Switch Proper Mounting Position (Detection at Stroke End) and Its Mounting Height

- D-M9□
- D-M9□V
- D-M9□W
- D-M9□WV
- D-M9□A
- D-M9□AV

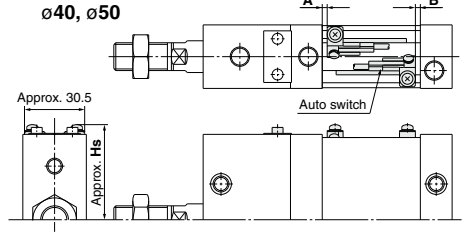
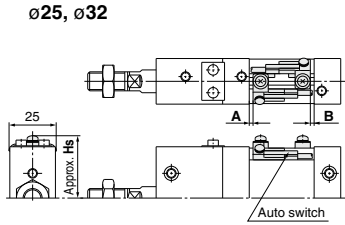

- D-A7□
- D-A80
- D-A7□H
- D-A80H
- D-F7□
- D-J79
- D-F7□W
- D-J79W
- D-F79F
- D-F7NT
- D-F7BA
- D-A73C
- D-A80C
- D-J79C
- D-A79W
- D-F7□WV
- D-F7□V
- D-F7BAV

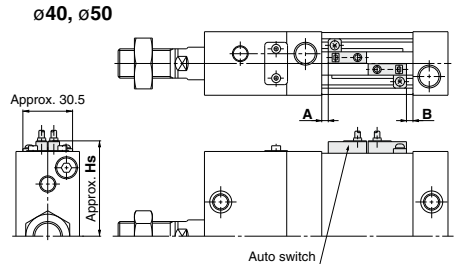
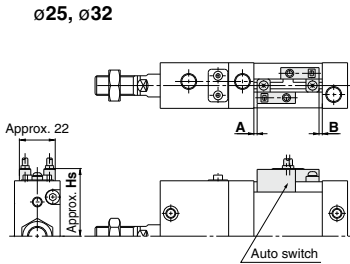

D-P3DWA

ø25 to ø50

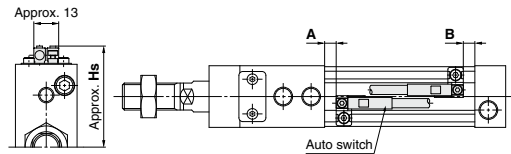

D-P4DW

ø40, ø50

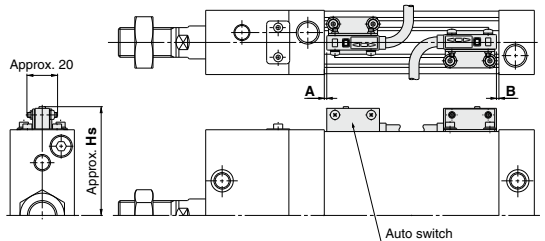

Auto Switch Proper Mounting Position (Detection at Stroke End) and Its Mounting Height

Auto Switch Proper Mounting Position (mm)

Auto switch model	D-M9□		D-A73□ D-A80		D-A72□ D-A7□H D-A80H D-F7□ D-F7□V D-J79 D-F7□W D-F7□WV D-J79W D-F7BA D-F7BAV D-F79F		D-A73C□ D-A80C□ D-J79C		D-A79W		D-F7NT		D-P3DWA		D-P4DW	
	A	B	A	B	A	B	A	B	A	B	A	B	A	B	A	B
25	5.5	6	4	4.5	4.5	5	4.5	5	1.5	2	9.5	10	2.5	3	—	—
32	5.5	6	4	4.5	4.5	5	4.5	5	1.5	2	9.5	10	2.5	3	—	—
40	6	6.5	4.5	5	5	5.5	0	0	2	2.5	10	10.5	3	3.5	0.5	1
50	7.5	8	6	6.5	6.5	7	0.5	1	3.5	4	11.5	12	4.5	5	2	2.5

Note) Adjust the auto switch after confirming the operating conditions in the actual setting.

Auto Switch Mounting Height (mm)

Auto switch model	D-M9□		D-A7□ D-A80		D-A7□H D-80H D-F7□ D-J79 F-F7□W D-F7NT D-F79F D-F7BA		D-A73C□ D-A80C□		D-F7□V D-F7□WV D-F7BAV		D-J79C		D-A79W		D-P3DWA		D-P4DW	
	Hs		Hs		Hs		Hs		Hs		Hs		Hs		Hs		Hs	
25	33.5		32		33		39		35.5		37.5		34.5		37.5		—	
32	40.5		39		40		46		42.5		44.5		41.5		44.5		—	
40	48.5		47		48		54		50.5		52.5		49.5		52.5		56.5	
50	58		56		57		63		59.5		61.5		58.5		62		66	

Minimum Stroke for Auto Switch Mounting (mm)

Number of auto switches	Bore size	D-M9□V		D-M9□WV		D-M9□AV		D-M9□ D-M9□W		D-M9□A	
		Different side(s)	Same side	Different side(s)	Same side	Different side(s)	Same side	Different side(s)	Same side	Different side(s)	Same side
1 pc.	25 to 50	5		10		10		15		15	
	25, 32	10		15		15		15		20	
2 pcs.	40, 50	10	30	15	30	15	35	15	40	20	45

Number of auto switches	D-F7□V D-J79C	D-A7□ D-A80 D-A73C D-A80C		D-F7□WV D-F7BAV		D-A7□H/A80H D-A79W D-F7□W/J79C D-F7□W/F7□WV D-J79W/F7NT D-F7BA/F7NT D-F79F		D-P3DWA		D-P4DW*	
		Different side(s)	Same side	Different side(s)	Same side	Different side(s)	Same side	Different side(s)	Same side	Different side(s)	Same side
1 pc.	5	5		10		15		15		20	
2 pcs.	5	10		15		15		15		20, 75	

* Only size 40 and 50 can be mounted.

Operating Range (mm)

Auto switch model	Bore size			
	25	32	40	50
D-M9□/M9□V D-M9□W/M9□WV D-M9□A/M9□AV	4.5	5.5	7	7
D-A7□/A80 D-A7□H/A80H D-A73C/A80C	13	13	13	13
D-A79W	13	13	14	14

Auto switch model	Bore size			
	25	32	40	50
D-F7□/J79 D-F7□W/J79C D-F7□W/F7□WV D-J79W/F7NT D-F7BA/F7BAV D-F79F	6.5	7	6.5	6.5
D-P3DWA	6	6.5	6	6
D-P4DW	—	—	5	5

* Since the operating range is provided as a guideline including hysteresis, it cannot be guaranteed (assuming approximately ±30% dispersion). It may vary substantially depending on an ambient environment.

- CLJ2
- CLM2
- CLG1
- CL1
- MLGC
- CNG
- MNB
- CNA2
- CNS
- CLS
- CLQ
- RLQ
- MLU
- MLGP
- ML1C

- D-□
- X□

MLU Series Auto Switch Mounting 2

Auto Switch Mounting Bracket Part No.

Auto switch model	Bore size (mm)			
	ø25	ø32	ø40	ø50
D-M9□ D-M9□V D-M9□W D-M9□WV D-M9□A D-M9□AV	①BMU1-025 ②BQ2-012 Two kinds of auto switch mounting brackets are used as a set.			
D-A7□/A80 D-A73C/A80C D-A7□H/A80H D-A79W D-F7□/J79 D-F7□V D-J79C D-F7□W/J79W D-F7□WV D-F7BA/F7BAV D-F79F/F7NT	BMU1-025			
D-P4DW	—		BMU2-040	

Auto switch model	Bore size (mm)			
	ø25	ø32	ø40	ø50
D-P3DWA	BMU4-040S			
Note 1) The tightening torque for a hexagon socket head cap screw (M2.5) is 0.2 to 0.3 N·m. Hold the shorter side of a hexagon wrench, and turn it to tighten. (Too much tightening may break the switch)				
Note 2) The tightening torque for a hexagon socket head cap screw (M3) is 0.5 to 0.7 N·m.				

[Mounting screw set made of stainless steel]

The following set of mounting screws made of stainless steel (including nuts) is available. Use it in accordance with the operating environment.

BBA2: For D-A7/A8/F7/J7 types

D-F7BA/D-F7BAV are set on the cylinder with the stainless steel screws above when shipped.

When an auto switch is shipped independently, BBA2 is attached.

Note 1) Refer to page 1229 for the details of BBA2.

Note 2) When mounting D-M9□A(V), order auto switch mounting brackets, stainless steel screw set BBA2 and BQ2-012S separately.

Other than the applicable auto switches listed in "How to Order", the following auto switches can be mounted. For detailed specifications, refer to pages 1119 to 1245.

Auto switch type	Model	Electrical entry direction	Features	Applicable bore size
Solid state	D-F7NV, F7PV, F7BV	Grommet (perpendicular)	—	ø25 to ø50
	D-F7NWV, F7BWW		Diagnostic indication (2-color indicator)	
	D-F7BAVL		Water resistant (2-color indicator)	
	D-F79, F7P, J79	Grommet (in-line)	—	
	D-F79W, F7PW, J79W		Diagnostic indication (2-color indicator)	
	D-F7NT		With timer	
	D-F7BA		Water resistant (2-color indicator)	
	D-P5DW		Magnetic field resistant (2-color indicator)	
			ø40, ø50	

* For solid state auto switches, auto switches with a pre-wired connector are also available. Refer to pages 1192 and 1193.

* Normally closed (NC = b contact) solid state auto switches (D-M9□E(V)) are also available. Refer to page 1592-1 for details.



MLU Series

Specific Product Precautions 1

Be sure to read this before handling the products.

Refer to back page 50 for Safety Instructions and pages 3 to 12 for Actuator and Auto Switch Precautions.

Selection

Warning

1. The holding force (max. static load) indicates the maximum capability to hold a static load without vibration and impact. The maximum load (workpiece mass) should be below 50% of the holding force (max. static load). Refer to 6 below when the kinetic energy of the workpiece is absorbed at the cylinder end or eccentric load is applied.

2. Do not use for intermediate cylinder stops.

This cylinder is designed for locking against inadvertent movement from a stationary condition. Intermediate stops during operation with the locking mechanism may damage the cylinder, greatly shorten the service life or cause unlocking malfunction.

3. Select the correct locking direction, as this cylinder does not generate holding force opposite to the locking direction.

The extension lock does not generate holding force in the cylinder's retracting direction, and the retraction lock does not generate holding force in the cylinder's extension direction.

4. Even when locked, there may be a stroke movement of approximately 1 mm in the locking direction due to external forces, such as the workpiece mass.

Even when locked, if air pressure drops, a stroke movement of approximately 1 mm may be generated in the locking direction of the lock mechanism due to external forces such as the workpiece mass.

5. When locked, do not apply impact loads, stroke vibration or rotational force, etc.

This may damage the locking mechanism, shorten the service life or cause unlocking malfunction.

6. Operate so that load mass, maximum speed and eccentric distance are within the limiting ranges in the graphs below.

Operation beyond the limiting range will lead to cylinder damage and reduced service life, etc.

Allowable Kinetic Energy (Energy absorbable at the cylinder end)

Extension locking direction

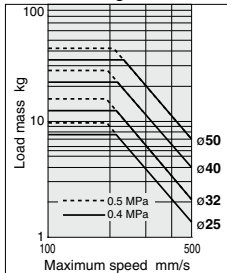

Retraction locking direction

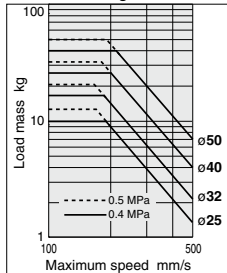

Allowable Load Mass

Horizontal (without switch and with switch)

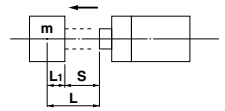
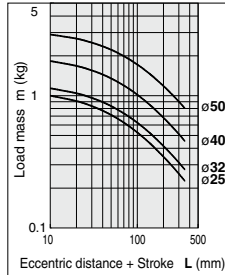

L1: Eccentric distance (mm)
S: Stroke (mm)

Pneumatic Circuit

Warning

• Drop prevention circuit

1. Do not use 3 position valves with the circuit example 1.

The lock may be released due to inflow of the unlocking pressure.

2. Install speed controllers for meter-out control. (Circuit example 1)

When they are not installed or they are used under meter-in control, it may cause malfunction.

3. Branch off the compressed air piping for the lock unit between the cylinder and the speed controller. (Circuit example 1)

Note that branching off in other sections may shorten the service life.

4. Perform piping so that the side going from the piping junction to the lock release port is short. (Circuit example 1)

If the lock release port side is longer than another side from the piping junction, this may cause unlocking malfunction or shorten the service life.

5. Be careful of reverse exhaust pressure flow from a common exhaust type valve manifold. (Circuit example 1)

Since the lock may be released due to reverse exhaust pressure flow, use an individual exhaust type manifold or single type valve.

6. Be sure to release the lock before operating the cylinder. (Circuit example 2)

When the lock release delays, the cylinder may eject at high speed, which is extremely dangerous. It may also damage the cylinder, greatly shorten the service life or cause the locking malfunction. Even when the cylinder moves freely, be sure to release the lock and operate the cylinder.

7. Be aware that the locking action may be delayed due to the piping length or the timing of exhaust. (Circuit example 2)

The locking action may be delayed due to the piping length or the timing of exhaust, which also makes the stroke movement toward the lock larger. Install the solenoid valve for locking closer to the cylinder than the cylinder drive solenoid valve.

CLJ2

CLM2

CLG1

CL1

MLGC

CNG

MNB

CNA2

CNS

CLS

CLQ

RLQ

MLU

MLGP

ML1C

D-□

-X□



MLU Series

Specific Product Precautions 2

Be sure to read this before handling the products.

Refer to back page 50 for Safety Instructions and pages 3 to 12 for Actuator and Auto Switch Precautions.

Pneumatic Circuit

Warning

• Emergency stop circuit

1. Perform emergency stops with the pneumatic circuit. (Circuit examples 3 and 4)

This cylinder is designed for locking against inadvertent movement from a stationary condition. Do not perform intermediate stops while the cylinder is operating, as this may cause unlocking malfunction or shorten the service life. Emergency stops must be performed with the pneumatic circuit, and workpieces must be held with the locking mechanism after the cylinder fully stops.

2. When restarting the cylinder from the locked state, remove the workpiece and exhaust the residual pressure in the cylinder. (Circuit examples 3 and 4)

A cylinder may eject at high speed, which is extremely dangerous. It may also damage the cylinder, greatly shorten the service life or cause the locking malfunction.

3. Be sure to release the lock before operating the cylinder. (Circuit example 4)

When the lock release delays, the cylinder may eject at high speed, which is extremely dangerous. It may also damage the cylinder, greatly shorten the service life or cause the locking malfunction. Even when the cylinder moves freely, be sure to release the lock and operate the cylinder.

• Drop prevention circuit, Emergency stop circuit

1. If installing a solenoid valve for a lock unit, be aware that repeated supply and exhaustion of air may cause condensation. (Circuit examples 2 and 4)

The lock unit operating stroke is very small and so the pipe is long. If supplying and exhausting air repeatedly, condensation, which occurs by adiabatic expansion, accumulates in the lock unit. This may then cause air leakage and an unlocking malfunction due to corrosion of internal parts.

Circuit example

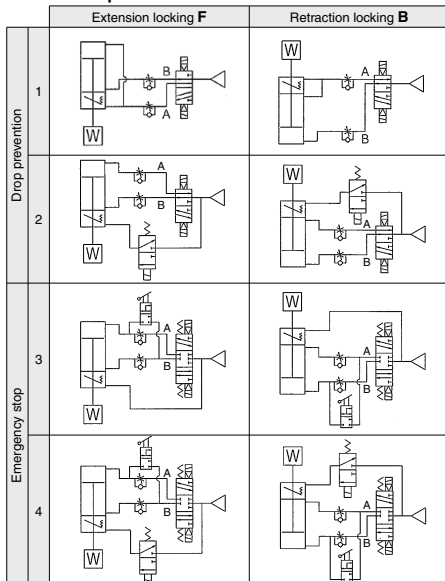

* The symbol for the cylinder with lock in the basic circuit uses SMC original symbol.

Mounting

Caution

1. Be sure to connect the load to the rod end with the cylinder in an unlocked condition.

If this is done when in a locked condition, it may cause damage to the lock mechanism.

2. When fixing a work piece at the end of the piston rod, first retract the piston rod to the back end. Use the spanner hook at the end of the rod to keep the torque below the allowable tightening torque.

3. Always apply the piston rod load in the axial direction. Avoid operation where rotational torque is applied. If it is the only possible way, be sure to use it within the allowable range shown in the table below.

Allowable Rotational Torque

(N·m)

Size	25	32	40	50
Allowable rotational torque	0.25	0.25	0.55	1.25
Allowable torque for workpiece mounting	1.7	1.9	2.0	4.9

4. The piston speed may exceed the maximum operating speed of 500 mm/s if the piping is directly connected to the cylinder. Please use speed controllers by SMC to adjust the piston speed so that it will not exceed 500 mm/s.

Preparing for Operation

Warning

1. When starting operation from the locked position, be sure to restore air pressure to the B line in the pneumatic circuit.

When pressure is not applied to the B line, the load may drop or the cylinder may eject at high speed, which is extremely dangerous. It may also damage the cylinder, greatly shorten the service life or cause unlocking malfunction. When applying pressure to the B line, be sure to confirm whether the environment is safe since a workpiece may move.

2. Shipped in the unlocked condition maintained by the unlocking bolt. Be sure to remove the unlocking bolt following the procedures below before operation.

The locking mechanism will not be effective without the removal of the unlocking bolt.

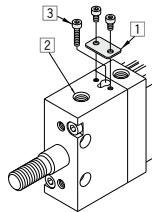

- 1) Confirm that there is no air pressure inside the cylinder, and remove dust cover 1.
- 2) Supply air pressure of 0.2 MPa or more to unlocking port 2 shown in the drawing on the left.
- 3) Use a hexagon wrench (ø25, ø32: Width across flats 2.5, ø40, ø50: Width across flats 3) to remove unlocking bolt 3.



MLU Series

Specific Product Precautions 3

Be sure to read this before handling the products.

Refer to back page 50 for Safety Instructions and pages 3 to 12 for Actuator and Auto Switch Precautions.

Manually Unlocking

Warning

1. Do not perform unlocking when an external force such as a load or spring force is being applied.

This is very dangerous because the cylinder will move suddenly. Release the lock after preventing cylinder movement with a lifting device such as a jack.

2. After confirming safety, operate the manual release following the steps shown below.

Carefully confirm that no one is inside the load movement range, etc., and that there is no danger even if the load moves suddenly.

Manually unlocking

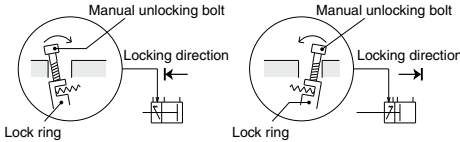

Extension locking direction

- 1) Remove the dust cover.
- 2) Screw a manual unlocking bolt (a conventional bolt of $\phi 25$, $\phi 32$, M3 x 0.5 x 25 L or more, $\phi 40$, $\phi 50$: M4 x 0.7 x 35 L or more) into the lock ring threads as shown above, and lightly push the bolt in the direction of the arrow (head side) to unlock.

Retraction locking direction

- 1) Remove the dust cover.
- 2) Screw a manual unlocking bolt (a conventional bolt of $\phi 25$, $\phi 32$, M3 x 0.5 x 25 L or more, $\phi 40$, $\phi 50$: M4 x 0.7 x 35 L or more) into the lock ring threads as shown above, and lightly push the bolt in the direction of the arrow (rod side) to unlock.

Maintenance

Caution

1. In order to maintain good performance, operate with clean unlubricated air.

If lubricated air, compressor oil or drainage, etc., enter the cylinder, there is a danger of sharply reducing the locking performance.

2. Do not apply grease to the piston rod.

There is a danger of sharply reducing the locking performance.

3. Never disassemble the lock unit.

It contains a heavy duty spring which is dangerous. There is also a danger of reducing the locking performance.

Holding the Unlocked State

Warning

1. Sizes MLU can hold the unlocked condition.

<Holding the unlocked condition>

- 1) Remove the dust cover.
- 2) Supply air pressure of 0.2 MPa or more to the unlocking port, and set the lock ring to the perpendicular position.
- 3) Screw the unlocking bolt which is included (hexagon socket head screw $\phi 25$, $\phi 32$: M3 x 12 L, $\phi 40$, $\phi 50$: M4 x 16 L) into the lock ring to hold the unlocked condition.

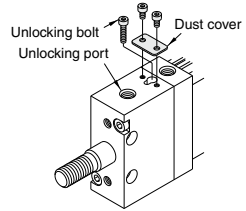

2. To use the locking mechanism again, be sure to remove the unlocking bolt.

The locking mechanism will not function with the unlocking bolt screwed-in. Remove the unlocking bolt according to the procedures described in the section "Preparing for Operation".

Auto Switch Handling Precautions

Warning

1. If two or more cylinders are used in close proximity, the auto switches may malfunction affected by the magnets built in the nearby cylinder.

Please keep the cylinder mounting pitch larger than the values in the table below.

Minimum cylinder mounting pitch

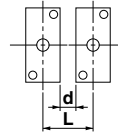

Size	25	32	40	50
L (d)	33 (10)	32 (5)	36 (5)	38 (0)

When the mounting pitch is equal to or smaller than the value shown above, it has to be shielded by an iron plate or a magnetic shielding plate (Part No. MU-S025) purchased separately. Please contact SMC for more information.

- CLJ2
- CLM2
- CLG1
- CL1
- MLGC
- CNG
- MNB
- CNA2
- CNS
- CLS
- CLQ
- RLQ
- MLU
- MLGP
- ML1C

- D-□
- X□