

# Basic Type/Direct Mount Type

## *CY3B/CY3R Series*

ø6, ø10, ø15, ø20, ø25, ø32, ø40, ø50, ø63

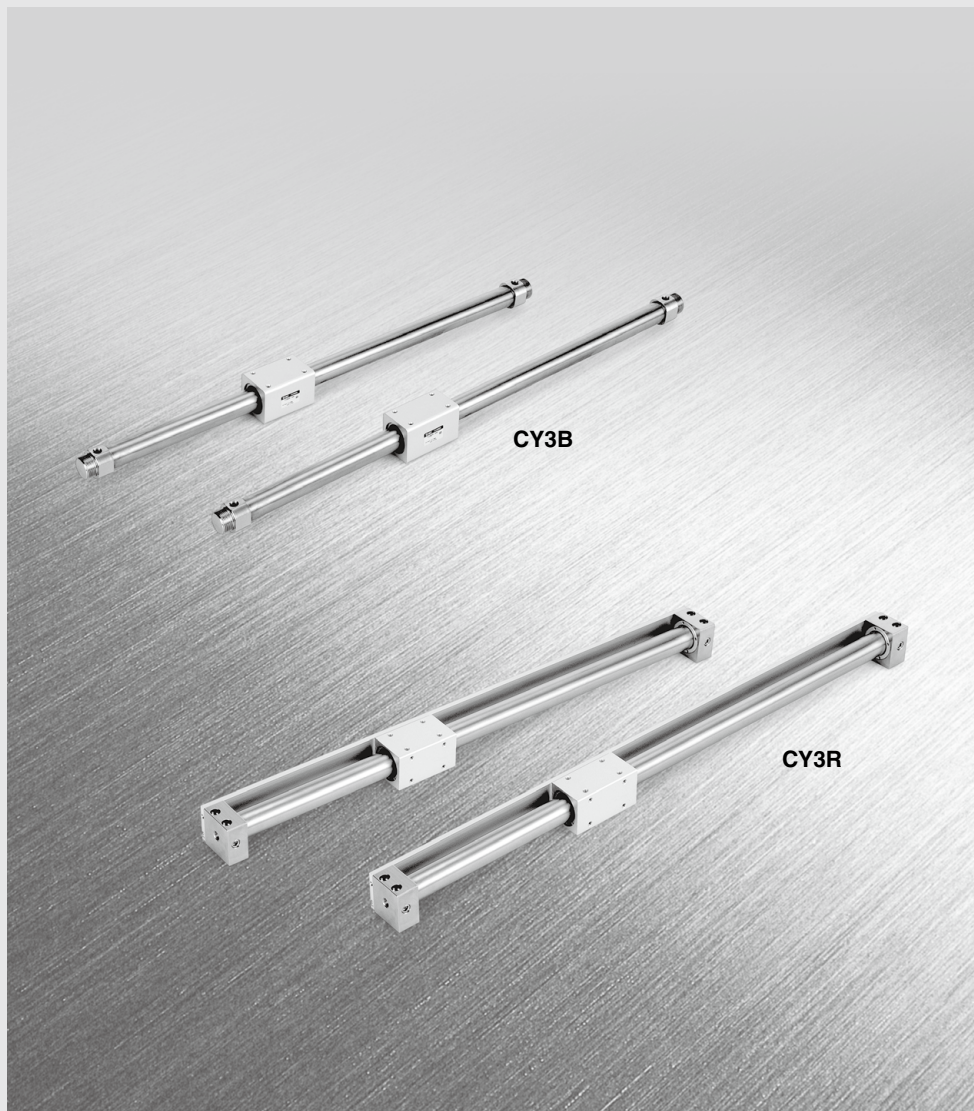

**CY3B**  
**CY3R**

**CY1S**

**CY1L**

**CY1H**

**CY1F**

**CYP**

**D-□**

**-X□**

Technical  
Data

Magnetically  
Coupled  
Rodless  
Cylinder

Basic type      Direct mount type  
**CY3B/CY3R Series**

## Improved durability

### Improved bearing performance

A 70% longer wear ring length achieving an improvement in bearing performance compared to the CY1B.

### Improved lubrication by using a Lube-retainer

A special resin Lube-retainer is installed on the dust seal to achieve ideal lubrication on the external surface of the cylinder tube.

Direct mount type **CY3R Series**



Basic type **CY3B Series**



## Series Variations

Series	Bore size	Standard stroke (mm)										Individual Made-to-Order products								
		50	100	150	200	250	300	350	400	450	500	600	700	800	900	1000				
CY3B	ø6	●	●	●	●	●	●	●	●	●	●	●	●	●	●	●				
	ø10	●	●	●	●	●	●	●	●	●	●	●	●	●	●	●				
	ø15	●	●	●	●	●	●	●	●	●	●	●	●	●	●	●				
	ø20	●	●	●	●	●	●	●	●	●	●	●	●	●	●	●	●			
	ø25	●	●	●	●	●	●	●	●	●	●	●	●	●	●	●	●			
	ø32	●	●	●	●	●	●	●	●	●	●	●	●	●	●	●	●	●		
	ø40	●	●	●	●	●	●	●	●	●	●	●	●	●	●	●	●	●	●	
CY3R	ø6	●	●	●	●	●	●	●	●	●	●	●	●	●	●	●				
	ø10	●	●	●	●	●	●	●	●	●	●	●	●	●	●	●				
	ø15	●	●	●	●	●	●	●	●	●	●	●	●	●	●	●				
	ø20	●	●	●	●	●	●	●	●	●	●	●	●	●	●	●	●			
	ø25	●	●	●	●	●	●	●	●	●	●	●	●	●	●	●	●			
	ø32	●	●	●	●	●	●	●	●	●	●	●	●	●	●	●	●	●		
	ø40	●	●	●	●	●	●	●	●	●	●	●	●	●	●	●	●	●	●	
ø50	●	●	●	●	●	●	●	●	●	●	●	●	●	●	●	●	●	●	●	
ø63	●	●	●	●	●	●	●	●	●	●	●	●	●	●	●	●	●	●	●	

Note) The ● mark indicates the available combination of bore size and standard stroke.

Availability of Made to Order products varies with the series and the bore size. For more information, please refer to pages 1703 to 1896.

# Upgraded version of space saving magnetically rodless cylinder!

## Reduction of sliding resistance

### Minimum operating pressure reduced by 30%

By using a Lube-retainer, the minimum operating pressure is reduced by 30%.

(CY3B40 compared with CY1B40)

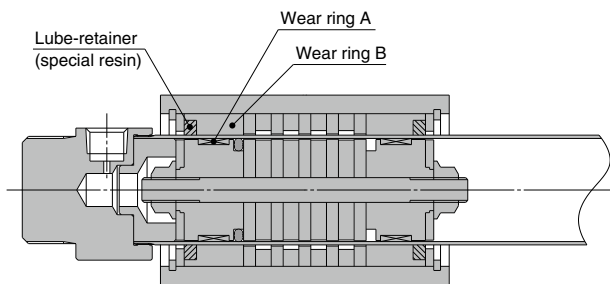

■ CY3B Series ■

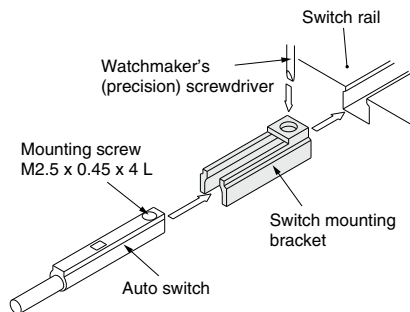

### Small auto switches are mountable.

Small auto switches can be mounted on the current auto switch mounting groove of the CY3R25 to 63. So, they can be mounted to all of the cylinder sizes in the CY3R series, making inventory control of the product easy.

### Lightweight

The body weight has been reduced by approximately 10% by eliminating unnecessary body weight and by reducing the outer diameter of the cylinder tube. (Compared with previous  $\phi 50$  and  $\phi 60$  models)

CY3B  
CY3R

CY1S

CY1L

CY1H

CY1F

CYP

D-□

-X□

Technical  
Data



# CY3B/CY3R Series Model Selection

E: Kinetic energy of load (J)

$$E = \frac{(W + W_s)}{2} \times \left( \frac{V}{1000} \right)^2$$

Es: Allowable kinetic energy for intermediate stop using an air pressure circuit (J)

Fn: Allowable driving force (N)

Mb: Maximum allowable moment (N·m) when a connection bracket, etc. is carried directly

Ps: Operating pressure limit for intermediate stop using an external stopper, etc. (MPa)

Pv: Maximum operating pressure for vertical operation (MPa)

W<sub>Bmax</sub>: Maximum load mass (kg) when loaded directly on the body

Wv: Allowable load mass for vertical operation (kg)

Operating Conditions	
W: Load mass (kg)	Switches
W <sub>s</sub> : Connection bracket weight (kg)	P: Operating pressure (MPa)
μ: Guide's coefficient of friction	V: Speed (mm/s)
L <sub>s</sub> : Distance from cylinder shaft center to workpiece point of application (cm)	Stroke (mm)
Mode of operation (horizontal, inclined, vertical)	
L: Distance from cylinder shaft center to connection fitting, etc. (mm)	

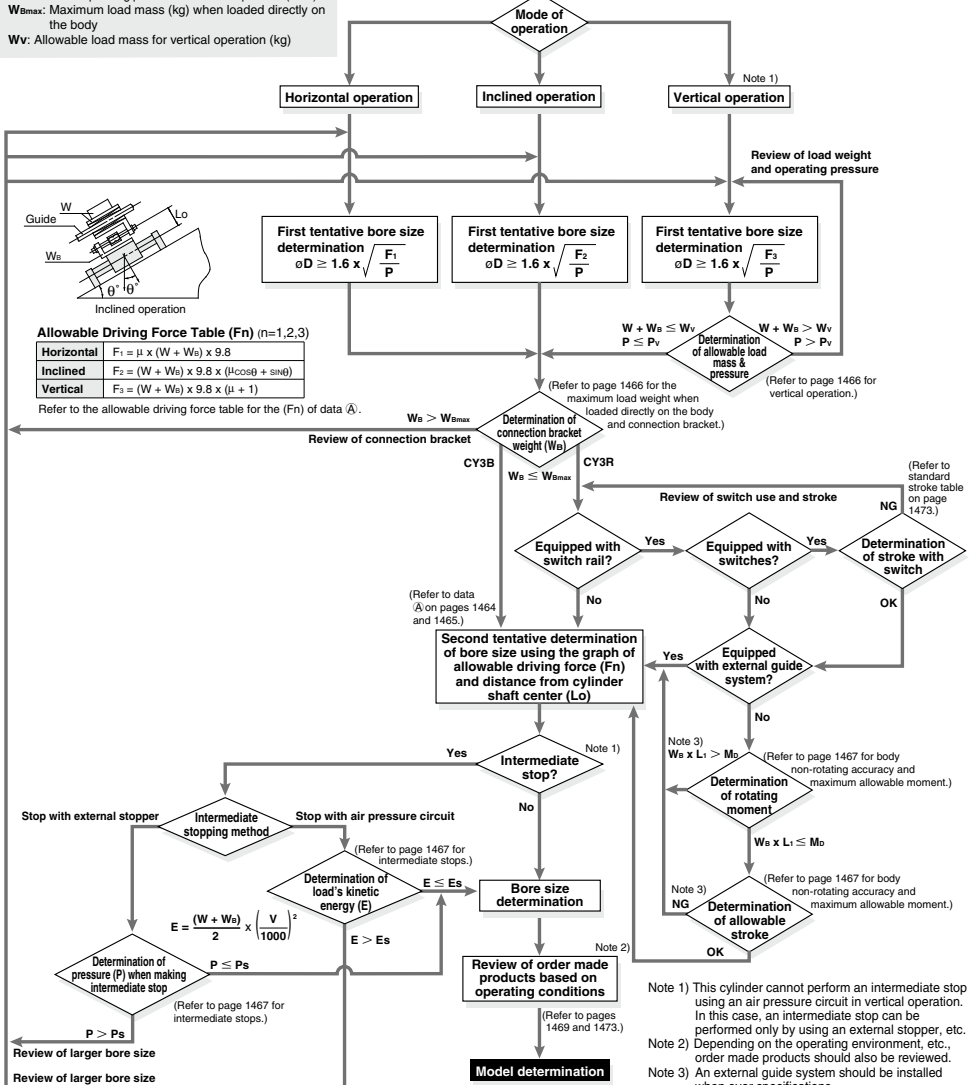

CY3B  
CY3R

CY1S

CY1L

CY1H

CY1F

CYP

D-□

-X□

Technical Data

Note 1) This cylinder cannot perform an intermediate stop using an air pressure circuit in vertical operation. In this case, an intermediate stop can be performed only by using an external stopper, etc.

Note 2) Depending on the operating environment, etc., order made products should also be reviewed.

Note 3) An external guide system should be installed when over specifications.

# CY3B/CY3R Series

## Precautions on Design 1

### Selection Procedure

#### Selection procedure

1. Find the drive resisting force  $F_n$  (N) when moving the load horizontally.
2. Find the distance  $L_o$  (cm) from the point of the load where driving force is applied, to the center of the cylinder shaft.
3. Select the bore size from  $L_o$  and  $F_n$ , based on data (A).

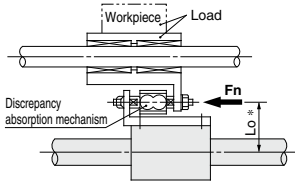

#### Selection example

Given a load drive resisting force of  $F_n = 100$  (N) and a distance from the cylinder shaft center to the load application point of  $L_o = 8$  cm, find the intersection point by extending upward from the horizontal axis of data (A) where the distance from the shaft center is 8 cm, and then extending to the side, find the allowable driving force on the vertical axis.

Models suitable in satisfying the requirement of 100 (N) are **CY3□32** or **CY3□40**.

\* The  $L_o$  point from the cylinder shaft center is the moment working point between the cylinder and the load section.

<Data (A): Distance from cylinder shaft center — Allowable driving capacity>

#### CY3B6

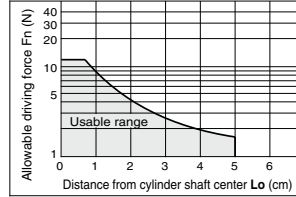

#### CY3B32

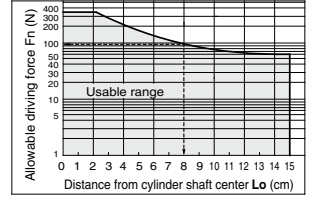

#### CY3B10

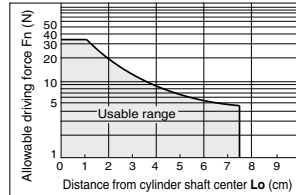

#### CY3B40

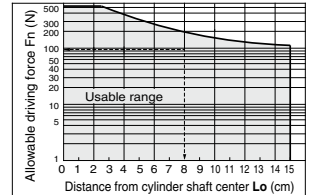

#### CY3B15

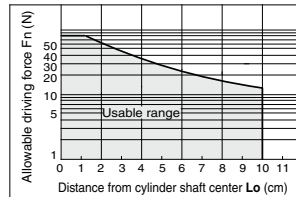

#### CY3B50

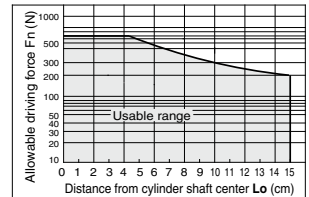

#### CY3B20

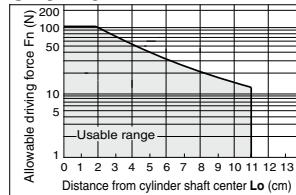

#### CY3B63

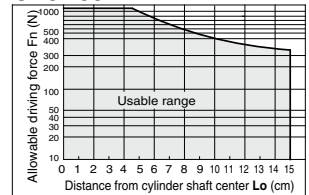

#### CY3B25

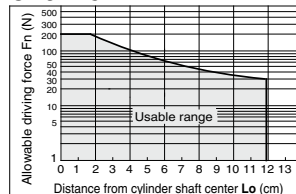

Precautions on Design 1

<Data (A) : Distance from cylinder shaft center — Allowable driving capacity>

**CY3R6**

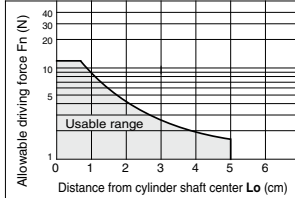

**CY3R32**

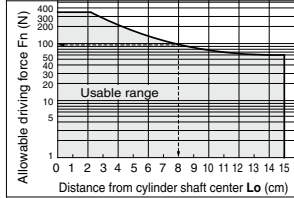

**CY3R10**

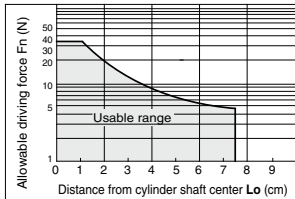

**CY3R40**

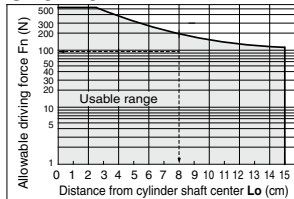

**CY3R15**

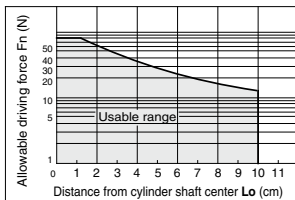

**CY3R50**

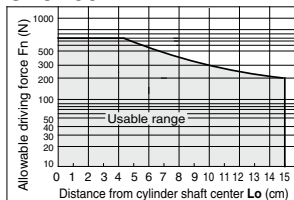

**CY3R20**

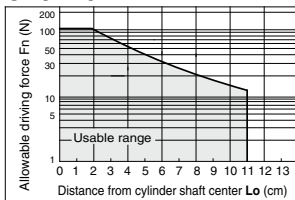

**CY3R63**

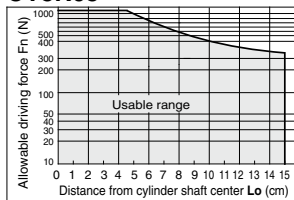

**CY3R25**

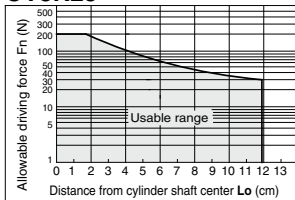

**CY3B**  
**CY3R**

**CY1S**

**CY1L**

**CY1H**

**CY1F**

**CYP**

**D**

**-X**

Technical  
Data

# CY3B/CY3R Series

## Precautions on Design 2

### Cylinder Dead Weight Deflection

When the cylinder is mounted horizontally, deflection appears due to its own weight as shown in the data, and the longer the stroke is, the greater the amount of variation in the shaft center. Therefore, a connection method should be considered which can assimilate this deflection.

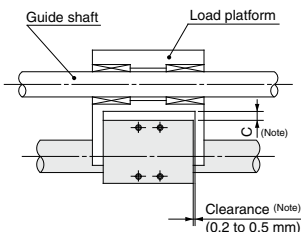

The above clearance amount is a reference value.

Note 1) According to the dead weight deflection in the figure on the right, provide clearance so that the cylinder does not touch the mounting surface or the load, etc., and is able to operate smoothly within the minimum operating pressure range for a full stroke. For more information, refer to operation manual.

Note 2) In case of the CY3R, install a shim, etc. to eliminate clearance between the body and the switch rail. For more information, refer to the CY3R operation manual.

Note 3) The amount of deflection differs from the CY1B/CY1R. Adjust the clearance value by referring to the dead weight deflection as shown in the table on the right.

**When CY1B/CY1R are replaced with CY3B/CY3R, install a cylinder after confirming a full stroke and clearance are allowed.**

### Vertical Operation

It is recommended that the load is guided by a ball type bearing (linear guide, etc.). If a slide bearing is used, sliding resistance increases due to the load mass and moment, which may cause malfunctions.

When the cylinder is mounted vertically or on an angle and is to make intermediate stops, use an external stopper, etc., for positioning. In addition, as the slider may move downwards toward the stroke end due to self-weight or the mass of the workpiece, use an external stopper, etc., for positioning if accurate positioning is required.

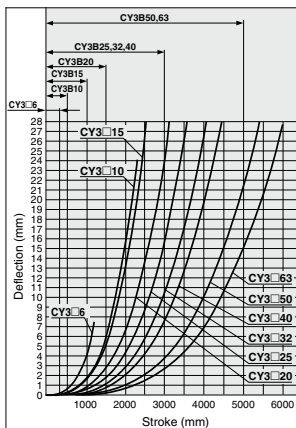
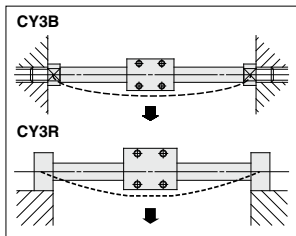
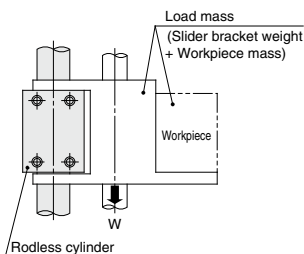

\* The above deflection data represent values at the time when the external sliding part moves to the middle of the stroke.

### Maximum Weight of Connection Bracket to the Body

The CY3B series is guided by an external axis (such as a linear guide) without directly mounting the load. When designing a metal bracket to connect the load, make sure that its weight will not exceed the value in the table below. Basically, guide the CY3R direct mounting type also with an external axis. (For connection methods, refer to the Operation Manual.)

#### Max. Connection Bracket Weight

Model	Max. connection bracket weight (W <sub>max</sub> ) (kg)
CY3_6	0.2
CY3_10	0.4
CY3_15	1.0
CY3_20	1.1
CY3_25	1.2
CY3_32	1.5
CY3_40	2.0
CY3_50	2.5
CY3_63	3.0

Consult with SMC in case a bracket with weight exceeding the above value is to be mounted.

### <CY3R>

### Maximum Load Mass when Loaded Directly on Body

When the load is applied directly to the body, it should be no greater than the maximum values shown in the table below.

Model	Max. load weight (W <sub>max</sub> ) (kg)
CY3R6	0.2
CY3R10	0.4
CY3R15	1.0
CY3R20	1.1
CY3R25	1.2
CY3R32	1.5
CY3R40	2.0
CY3R50	2.5
CY3R63	3.0

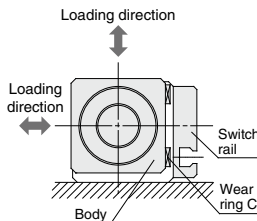

Bore size (mm)	Model	Allowable load mass (W <sub>v</sub> ) (kg)	Max. operating pressure (P <sub>v</sub> ) (MPa)
6	CY3_6	1.0	0.55
10	CY3_10	2.7	0.55
15	CY3_15	7.0	0.65
20	CY3_20	11.0	0.65
25	CY3_25	18.5	0.65
32	CY3_32	30.0	0.65
40	CY3_40	47.0	0.65
50	CY3_50	75.0	0.65
63	CY3_63	115.0	0.65

\* Use caution, as there is a danger of breaking the magnetic coupling if operated above the maximum operating pressure.



## Precautions on Design 3

### Intermediate Stop

#### (1) Intermediate stopping of load with an external stopper, etc.

When stopping a load in mid-stroke using an external stopper, etc., operate within the operating pressure limits shown in the table below. Use caution, as operation at a pressure exceeding these limits can result in breaking of the magnetic coupling.

Bore size (mm)	Model	Operating pressure limit for intermediate stop (Ps) (MPa)
6	CY3□6	0.55
10	CY3□10	0.55
15	CY3□15	0.65
20	CY3□20	0.65
25	CY3□25	0.65
32	CY3□32	0.65
40	CY3□40	0.65
50	CY3□50	0.65
63	CY3□63	0.65

#### (2) Intermediate stopping of load with an air pressure circuit

When performing an intermediate stop of a load using an air pressure circuit, operate at or below the kinetic energy shown in the table below. Use caution, as operation when exceeding the allowable value can result in breaking of the magnetic coupling.

(Reference values)

Bore size (mm)	Model	Allowable kinetic energy for intermediate stop (Es) (J)
6	CY3□6	0.007
10	CY3□10	0.03
15	CY3□15	0.13
20	CY3□20	0.24
25	CY3□25	0.45
32	CY3□32	0.88
40	CY3□40	1.53
50	CY3□50	3.12
63	CY3□63	5.07

### Stroke End Stopping Method

When stopping a load having a large inertial force at the stroke end, tilting of the body and damage to the bearings and cylinder tube may occur. (Refer to the left hand drawing below.)

As shown in the right hand drawing below, a shock absorber should be used together with the stopper, and thrust should also be transmitted from the center of the body so that tilting will not occur.

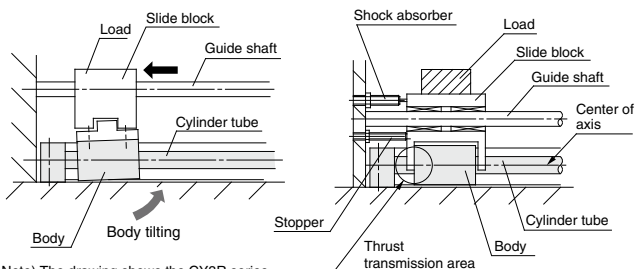

Note) The drawing shows the CY3R series.

#### <CY3R>

#### Body Non-rotating Accuracy and Maximum Allowable Moment (with Switch Rail)

(Reference values)

Reference values for non-rotating accuracy and maximum allowable moment at stroke end are indicated below.

Bore size (mm)	Non-rotating accuracy (°)	Max. allowable moment (M <sub>0</sub> ) (N·m)	Allowable stroke (mm) <sup>Note 2)</sup>
6	7.3	0.02	100
10	6.0	0.05	100
15	4.5	0.15	200
20	3.7	0.20	300
25	3.7	0.25	300
32	3.1	0.40	400
40	2.8	0.62	400
50	2.4	1.00	500
63	2.2	1.37	500

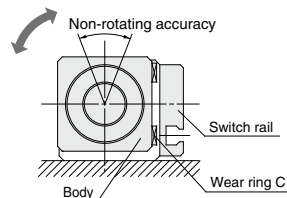

Note 1) Avoid operations where rotational torque (moment) is applied. In such a case, the use of an external guide is recommended.

Note 2) The above reference values will be satisfied within the allowable stroke ranges, but caution is necessary, because as the stroke becomes longer, the inclination (rotation angle) within the stroke can be expected to increase.

Note 3) When a load is applied directly to the body, the loaded weight should be no greater than the allowable load weight on page 1466.

**CY3B**  
**CY3R**

**CY1S**

**CY1L**

**CY1H**

**CY1F**

**CYP**

**D-□**

**-X□**

Technical  
Data

# Magnetically Coupled Rodless Cylinder/ Basic Type

# CY3B Series

ø6, ø10, ø15, ø20, ø25, ø32, ø40, ø50, ø63

## How to Order

**Basic type** **CY3B** **25**  - **300** -

• **Basic type**

• **Bore size**

6	6mm
10	10mm
15	15mm
20	20mm
25	25mm
32	32mm
40	40mm
50	50mm
63	63mm

• **Made to Order**  
Refer to page 1469 for details.

• **Standard stroke**  
Refer to the standard stroke table shown below.

• **Port thread type**

Symbol	Type	Bore size
Nil	M thread	6, 10, 15
	Rc	20, 25, 32, 40
TN	NPT	
TF	G	50, 63

## Standard Stroke

Bore size (mm)	Standard stroke (mm)	Maximum available stroke (mm)
6	50, 100, 150, 200	300
10	50, 100, 150, 200, 250, 300	500
15	50, 100, 150, 200, 250, 300, 350, 400, 450, 500	1000
20	100, 150, 200, 250, 300, 350, 400, 450, 500, 600, 700, 800	1500
25		3000
32		3000
40	3000	
50	5000	
63	100, 150, 200, 250, 300, 350, 400, 450, 500, 600, 700, 800, 900, 1000	5000

Note 1) Long stroke type (XB11) applies to the strokes exceeding 2000 mm. (Refer to page 1739.)

Note 2) The longer the stroke, the larger the amount of deflection in a cylinder tube. Pay attention to the mounting bracket and clearance value.

Note 3) Intermediate stroke is available in 1 mm increments.

## Specifications

Bore size (mm)	6	10	15	20	25	32	40	50	63
Fluid	Air								
Proof pressure	1.05 MPa								
Max. operating pressure	0.7 MPa								
Min. operating pressure	0.16	0.16	0.16	0.16	0.15	0.14	0.12	0.12	0.12
Ambient and fluid temperature	-10 to 60°C (No freezing)								
Piston speed	50 to 500 mm/s								
Cushion	Rubber bumper								
Lubrication	Not required (Non-lube)								
Stroke length tolerance (mm)	0 to 250 st: $+1.0_0^+$ , 251 to 1000 st: $+1.4_0^+$ , 1001 st to: $+1.8_0^+$								
Mounting orientation	Horizontal, Inclined, Vertical (Note)								
Mounting nut (2 pcs.)	Standard equipment (accessory)								
Magnet holding force (N)	19.6	53.9	137	231	363	588	922	1471	2256

Note) When vertically mounting, it is impossible to perform an intermediate stop by means of a pneumatic circuit.

**⚠ Caution** When calculating the actual thrust, design should consider the minimum actuating pressure.

## Theoretical Cylinder Thrust

### ø6, ø10

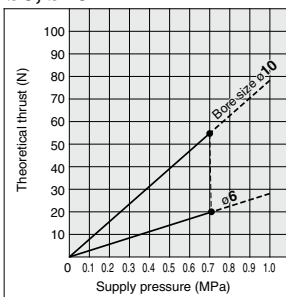

### ø15, ø20, ø25, ø32, ø40

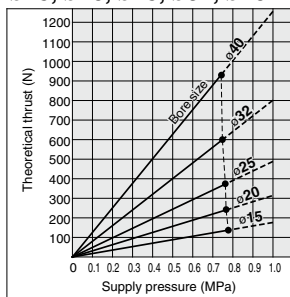

### ø50, ø63

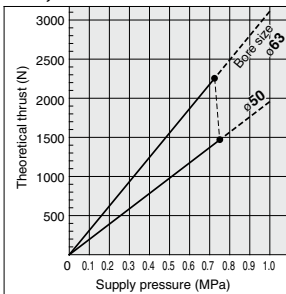

## Weight

Bore size (mm)	6	10	15	20	25	32	40	50	63
Basic weight (at 0 st)	0.052	0.08	0.275	0.351	0.672	1.287	2.07	3.2	5.3
Additional weight per 50 mm of stroke	0.004	0.014	0.015	0.02	0.023	0.033	0.04	0.077	0.096

Calculation method/Example: **CY3B32-500**

Basic weight.....1.287 kg  
 Additional weight.....0.033/50 st } 1.287 + 0.033 x 500 ÷ 50 = 1.617 kg  
 Cylinder stroke.....500 st }

Unit: kg



### Symbol

Rubber bumper (Magnet type)



Made to Order: Individual Specifications  
(For details, refer to pages 1480 to 1482.)

Symbol	Specifications
-X116	Hydro specifications
-X132	Axial ports
-X160	High speed specifications
-X168	Helical insert thread specifications
-X206	Added mounting tap positions for slider
-X210	Non-lubricated exterior specifications
-X322	Outside of cylinder tube with hard chrome plating
-X324	Non-lubricated exterior specifications (with dust seal)
-X1468	Interchangeable specification with CY1□6

### Made to Order

[Click here for details](#)

Symbol	Specifications
-XB6	Head resistant cylinder (-10 to 150°C)
-XB9	Low-speed cylinder (15 to 50mm/s)
-XB11	Long stroke type
-XB13	Low-speed cylinder (7 to 50mm/s)
-XC24	With magnetic shielding plate
-XC57	With floating joint

For clean specifications, refer to "Pneumatic Clean Series" catalog (CAT.E02-23).

**CY3B**  
**CY3R**

**CY1S**

**CY1L**

**CY1H**

**CY1F**

**CYP**

**D-□**

**-X□**

Technical  
Data

# CY3B Series

## Construction

### Basic type CY3B6

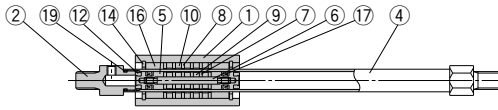

### CY3B10, 15

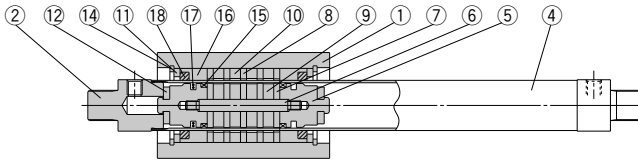
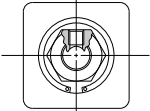

\* The above drawing is  $\phi 15$ . (3 magnets are used in  $\phi 10$ .)

### CY3B20 to 40

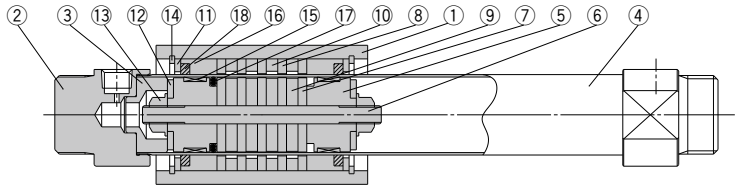
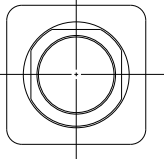

### CY3B50, 63

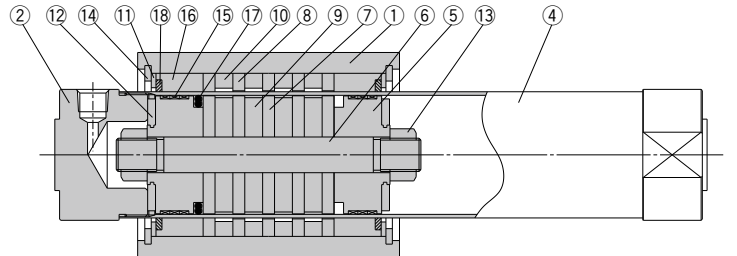
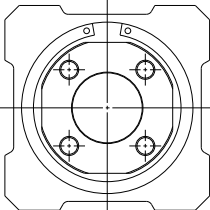

## Component Parts

No.	Description	Material	Note
1	Body	Aluminum alloy	Hard anodized
2	Head cover	$\phi 6, \phi 10$ Brass $\phi 15$ to $\phi 63$ Aluminum alloy	
3	End collar	Aluminum alloy	$\phi 20$ to $\phi 40$ only
4	Cylinder tube	Stainless steel	
5	Piston	$\phi 6$ Brass $\phi 10$ to $\phi 63$ Aluminum alloy	$\phi 6$ Electroless Ni plated $\phi 10$ to $\phi 63$ Chromated
6	Shaft	Stainless steel	
7	Piston side yoke	Rolled steel	Zinc chromated
8	External slider side yoke	Rolled steel	Zinc chromated
9	Magnet A	—	
10	Magnet B	—	
11	Spacer	Aluminum alloy	$\phi 6$ : not available
12	Bumper	Urethane rubber	
13	Piston nut	Carbon steel	$\phi 6$ to $\phi 15$ : not available
14	C type retaining ring for hole	Carbon tool steel	Phosphate coated
15	Wear ring A	Special resin	
16	Wear ring B	Special resin	
17	Piston seal	NBR	
18	Lube-retainer	Special resin	$\phi 6$ : not available
19	Cylinder tube gasket	NBR	$\phi 6, \phi 10$ only

## Replacement Parts/Seal Kit

Bore size (mm)	Kit no.	Contents
6	CY3B6-PS	Set of nos. above 16, 17, 19
10	CY3B10-PS	Set of nos. above 16, 17, 18, 19
15	CY3B15-PS	
20	CY3B20-PS	Set of nos. above 15, 16, 17, 18
25	CY3B25-PS	
32	CY3B32-PS	
40	CY3B40-PS	
50	CY3B50-PS	
63	CY3B63-PS	

Note 1) Seal kits are sets consisting of numbers 15 through 19. Order using the kit number corresponding to each bore size.

Note 2) Adhesive glue is applied to the thread fixed section of the head cover and cylinder tube. Contact SMC if the head cover removal is difficult.

Note 3) For replacement of the  $\phi 10$  wear ring A, contact SMC or your nearest sales representative.

\* Seal kit includes a grease pack ( $\phi 6, \phi 10$ : 5 and 10 g,  $\phi 15$  to  $\phi 63$ : 10 g). Order with the following part number when only the grease pack is needed.

**Grease pack part number for  $\phi 6, \phi 10$ : GR-F-005 (5 g)** For external sliding sections  
**GR-S-010 (10 g)** For tubing interior

**Grease pack part number for  $\phi 15$  to  $\phi 63$ : GR-S-010 (10 g)**

**Dimensions**

**Basic type**

**CY3B6 to 63**

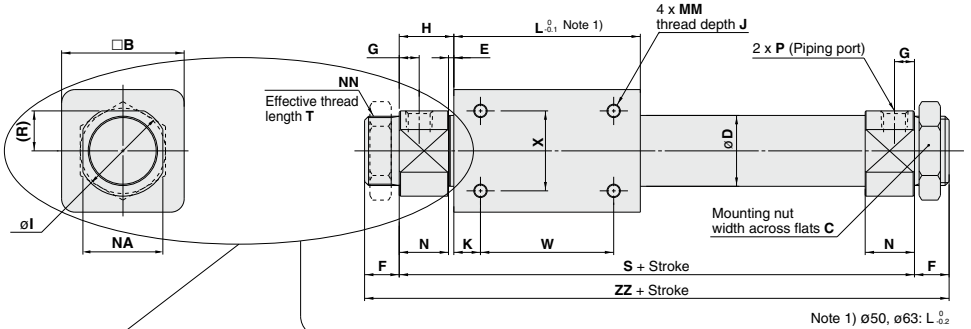

Note 1)  $\phi 50, \phi 63: L \phi_{0.2}$

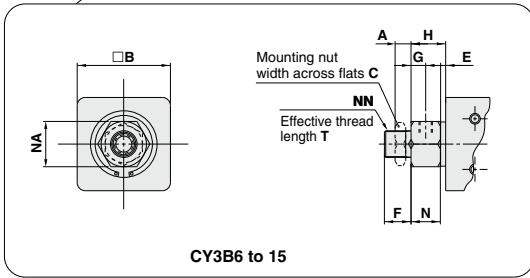

**CY3B6 to 15**

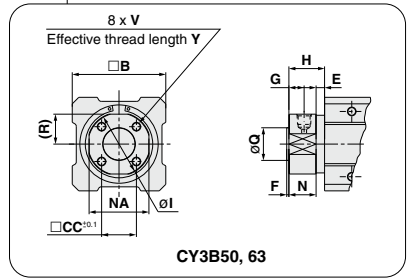

**CY3B50, 63**

Model	A	B	C	CC	D	E	F	G	H	I	J	K	L	MM	N	NA	NN	Q	R	S	T	V
CY3B6	4	17	8*	—	7.6	4	8*	5	13.5*	—	4.5	5	35	M3 x 0.5	9.5*	10*	M6 x 1*	—	—	62*	6.5	—
CY3B10	4	25	14	—	12	1.5	9	5	12.5	—	4.5	4	38	M3 x 0.5	11	14	M10 x 1	—	—	63	7.5	—
CY3B15	4	35	14	—	16.6*	2	10	5.5	13	—	6	11	57	M4 x 0.7	11	17	M10 x 1	—	—	83	8	—
CY3B20	8	36	26	—	21.6*	2*	13	7.5*	20	28	6	8	66	M4 x 0.7	18*	24	M20 x 1.5	—	12*	106	10	—
CY3B25	8	46	32	—	26.4*	2*	13	7.5*	20.5	34	8	10	70	M5 x 0.8	18.5*	30	M26 x 1.5	—	15*	111	10	—
CY3B32	8	60	32	—	33.6*	2*	16	8*	22	40	8	15	80	M6 x 1	20*	36	M26 x 1.5	—	18*	124	13	—
CY3B40	10	70	41	—	41.6*	3*	16	11	29	50	10	16	92	M6 x 1	26*	46	M32 x 2	—	23*	150	13	—
CY3B50	—	86	—	32	52.4*	8	2	14	33	58*	12	25	110	M8 x 1.25	25	55	—	30 <sup>+0.007/-0.007</sup>	27.5*	176	—	M8 x 1.25
CY3B63	—	100	—	38	65.4*	8	2	14	33	72*	12	26	122	M8 x 1.25	25	69	—	32 <sup>+0.007/-0.007</sup>	34.5*	188	—	M10 x 1.5

Model	W	X	Y	ZZ	P (Piping port)		
					NH	TN*	TF*
CY3B6	25	10	—	78*	M3 x 0.5*	—	—
CY3B10	30	16	—	81	M5 x 0.8	—	—
CY3B15	35	19	—	103	M5 x 0.8	—	—
CY3B20	50	25	—	132	Rc 1/8	NPT 1/8	G 1/8
CY3B25	50	30	—	137	Rc 1/8	NPT 1/8	G 1/8
CY3B32	50	40	—	156	Rc 1/8	NPT 1/8	G 1/8
CY3B40	60	40	—	182	Rc 1/4	NPT 1/4	G 1/4
CY3B50	60	60	16	180	Rc 1/4	NPT 1/4	G 1/4
CY3B63	70	70	16	192	Rc 1/4	NPT 1/4	G 1/4

Note 2) The asterisk denotes the dimensions which are different from the CY1B series.

Note 3) Mounting nuts can be screwed on only for the effective thread length of the head cover (T dimension). When mounting a cylinder, consider the thickness of flange, etc.

**Mounting Nut/Included in the package (2 pcs).**

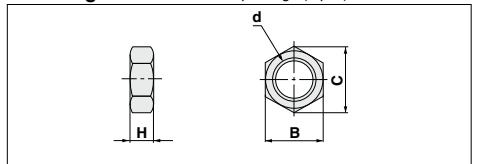

Part no.	Applicable bore size (mm)	d	H	B	C
SNJ-006B	6	M6 x 1.0	4	8	9.2
SNJ-016B	10, 15	M10 x 1.0	4	14	16.2
SN-020B	20	M20 x 1.5	8	26	30
SN-032B	25, 32	M26 x 1.5	8	32	37
SN-040B	40	M32 x 2.0	10	41	47.3

Note) Mounting nuts are not available for  $\phi 50$  and  $\phi 63$ .

CY3B  
CY3R

CY1S

CY1L

CY1H

CY1F

CYP

D-□

-X□

Technical  
Data

# Magnetically Coupled Rodless Cylinder/ Direct Mount Type

## CY3R Series

ø6, ø10, ø15, ø20, ø25, ø32, ø40, ø50, ø63

### How to Order

**CY3R** **25** - **300** - **M9BW** -

**Direct mount type**

**Piping type**

<b>Nil</b>	Standard type
<b>G</b>	Centralized piping type

\* Type G (centralized piping) is not available for ø6.

**Bore size**

6	6 mm
10	10 mm
15	15 mm
20	20 mm
25	25 mm
32	32 mm
40	40 mm
50	50 mm
63	63 mm

**Port thread type**

Symbol	Type	Bore size
<b>Nil</b>	M thread	6, 10, 15
	Rc	20, 25, 32, 40
<b>TN</b>	NPT	
<b>TF</b>	G	

**Number of auto switches**

<b>Nil</b>	2 pcs.
<b>S</b>	1 ps.
<b>n</b>	"n" pcs.

**Auto switch**

<b>Nil</b>	ø6 to ø15 ø25 to ø63	Without auto switch (Built-in magnet)
	ø20	Without auto switch (Built-in magnet for reed switch)
<b>M</b>		Without auto switch (Built-in magnet for solid state switch)

\* Refer to the table below for auto switch model numbers.

**Switch rail**

<b>Nil</b>	With switch rail
<b>N</b>	Without switch rail

Note 1) A type with switch rail has built-in auto switch magnets.  
 Note 2) ø15 has built-in auto switch magnets even without switch rail.  
 Note 3) Centralized piping type (G) is not available without switch rail (N).

**Cylinder stroke (mm)**  
 Refer to page 1473 for standard stroke.

### Applicable Auto Switches / Refer to pages 1575 to 1701 for further information on auto switches.

Type	Special function	Electrical entry	Indicator light	Wiring (output)	Load voltage		Auto switch model	Lead wire length (m)				Pre-wired connector	Applicable load		
					DC	AC		0.5 (Nil)	1 (M)	3 (L)	5 (Z)				
Solid state auto switch	—	Grommet	Yes	3-wire (NPN)	5 V, 12 V	—	<b>M9N</b>	●	●	○	○	IC circuit	Relay, PLC		
				3-wire (PNP)			<b>M9P</b>	●	●	○	○				
	2-wire			12 V	<b>M9B</b>		●	●	○	○	—				
	3-wire (NPN)			5 V, 12 V	<b>M9NW</b>		●	●	○	○	IC circuit				
	3-wire (PNP)				<b>M9PW</b>		●	●	○	○					
	Water resistant (2-color display)			2-wire	12 V		<b>M9BW</b>	●	●	○	○	—			
					3-wire (NPN)		5 V, 12 V	<b>M9NA</b> *1	○	○	●	○		IC circuit	
	3-wire (PNP)			12 V	<b>M9PA</b> *1		○	○	●	○	—				
	2-wire			12 V	<b>M9BA</b> *1		○	○	●	○		—			
	Reed auto switch			—	Grommet		Yes	3-wire (NPN equiv.)	—	5 V	<b>A96</b>	●		—	●
2-wire		24 V	5 V, 12 V			100 V		<b>A93</b>	●	●	●	●	—	—	Relay, PLC
		100 V or less	<b>A90</b>			●		—	●	—	—	—	—	IC circuit	

\*1 Water resistant type auto switches can be mounted on the above models, but in such case SMC cannot guarantee water resistance. Consult with SMC regarding water resistant types with the above model numbers.

\* Lead wire length symbols: 0.5 m..... Nil (Example) M9NW  
 1 m..... M (Example) M9NWM  
 3 m..... L (Example) M9NWL  
 5 m..... Z (Example) M9NwZ

\* Solid state auto switches marked "○" are produced upon receipt of order.

\* Other than the applicable auto switches listed in "How to Order", the other auto switches can be mounted. For detailed specifications, refer to page 1479.  
 \* With pre-wired connector is also available in solid state auto switches. For specifications, refer to pages 1648 and 1649.  
 \* The auto switch is shipped together, but not assembled.

## Specifications



### Symbol

Rubber bumper (Magnet type)

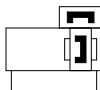

**Made to Order: Individual Specifications**  
(For details, refer to pages 1480 to 1482.)

Symbol	Specifications
-X116	Hydro specifications
-X160	High speed specifications
-X322	Outside of cylinder tube with hard chrome plating
-X1468	Interchangeable specification with CY1□6

### Made to Order

[Click here for details](#)

Symbol	Specifications
-XC57	With floating joint

For clean specifications, refer to "Pneumatic Clean Series" catalog (CAT.E02-23).

Bore size (mm)	6	10	15	20	25	32	40	50	63
Fluid	Air								
Proof pressure	1.05 MPa								
Max. operating pressure	0.7 MPa								
Min. operating pressure	0.16	0.16	0.16	0.16	0.15	0.14	0.12	0.12	0.12
Ambient and fluid temperature	-10 to 60°C (No freezing)								
Piston speed	50 to 500 mm/s								
Cushion	Rubber bumper								
Lubrication	Not required (Non-lube)								
Stroke length tolerance (mm)	0 to 250 st: $+1.0_0$ , 251 to 1000 st: $+1.4_0$ , 1001 st to: $+1.8_0$								
Mounting	Direct mount type								
Mounting orientation	Horizontal, Inclined, Vertical <sup>Note 2)</sup>								
Magnet holding force (N)	19.6	53.9	137	231	363	588	922	1471	2256

Note 1) When an auto switch is installed at an intermediate position of a type with auto switch, keep the maximum piston speed at 300 mm/s or below to ensure operation of relays or other devices.

Note 2) When vertically mounting, it is impossible to perform an intermediate stop by means of a pneumatic circuit.

## Standard Stroke

Bore size (mm)	Standard stroke (mm)	Max. stroke without switch (mm)	Max. stroke with switch (mm)
6	50, 100, 150, 200	300	300
10	50, 100, 150, 200, 250, 300	500	500
15	50, 100, 150, 200, 250, 300 350, 400, 450, 500	1000	750
20	100, 150, 200, 250, 300, 350 400, 450, 500, 600, 700, 800	1500	1000
25			1200
32	100, 150, 200, 250, 300, 350 400, 450, 500, 600, 700, 800 900, 1000	2000	1500
40			1500
50			1500
63			

Note 1) The longer the stroke, the larger the amount of deflection in a cylinder tube. Pay attention to the mounting bracket and clearance value.

Note 2) Intermediate stroke is available in 1 mm increments.

## Theoretical Cylinder Thrust

### ø6, ø10

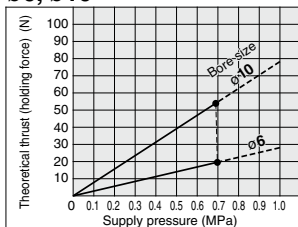

### ø15, ø20, ø25, ø32, ø40

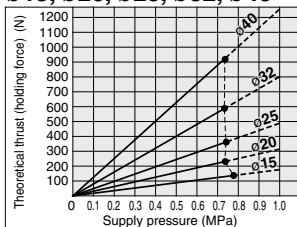

### ø50, ø63

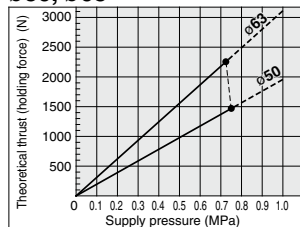

When calculating the actual thrust, design should consider the minimum actuating pressure.

## Weight

Unit: kg

Bore size (mm)		6	10	15	20	25	32	40	50	63
Basic weight (at 0 st)	With switch rail	0.086	0.111	0.272	0.421	0.622	1.217	1.98	3.54	5.38
	Without switch rail	0.069	0.08	0.225	0.351	0.542	1.097	1.82	3.25	5.03
Additional weight per 50 mm of stroke	With switch rail	0.016	0.034	0.040	0.051	0.056	0.076	0.093	0.159	0.188
	Without switch rail	0.004	0.014	0.015	0.020	0.023	0.033	0.040	0.077	0.096

Calculation method/Example: CY3R25-500 (with switch rail) Basic weight...0.622 (kg), Additional weight...0.056 (kg/50 st), Cylinder stroke...500 (st)  
0.622 + 0.056 x 500 ÷ 50 = 1.182 (kg)

CY3B  
CY3R

CY1S

CY1L

CY1H

CY1F

CYP

D-□

-X□

Technical Data

# CY3R Series

## Construction

### Both sides piping type CY3R6

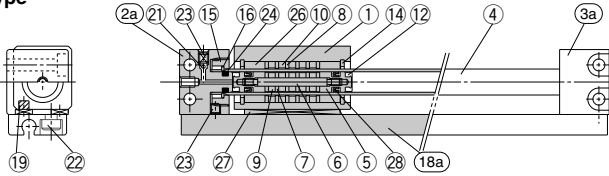

### CY3R10

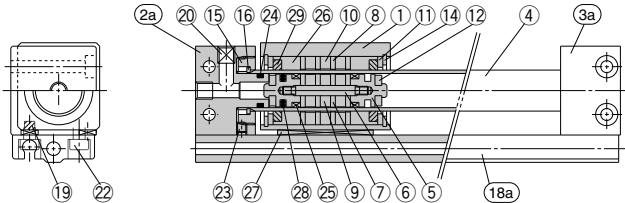

### CY3R15 to 63

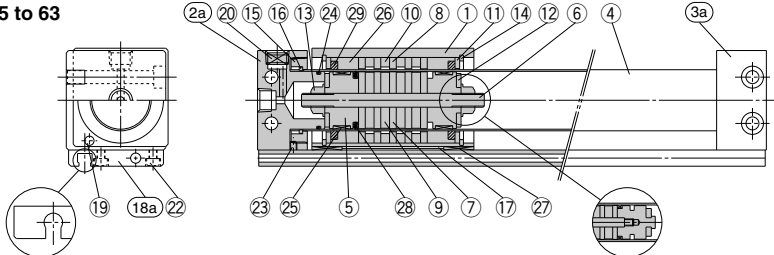

### CY3R15, 20

### CY3R15

### Component Parts

No.	Description	Material	Note
1	Body	Aluminum alloy	Hard anodized
2a	End cover A	Aluminum alloy	
2b	End cover C	Aluminum alloy	
3a	End cover B	Aluminum alloy	
3b	End cover D	Aluminum alloy	
4	Cylinder tube	Stainless steel	
5	Piston	ø6 Brass ø10 to ø63 Aluminum alloy	ø6 Electroless nickel plated ø10 to ø63 Chromate
6	Shaft	Stainless steel	
7	Piston side yoke	Rolled steel plate	Zinc chromated
8	External slider side yoke	Rolled steel plate	Zinc chromated
9	Magnet A	—	
10	Magnet B	—	
11	Spacer	Aluminum alloy	ø6: not available
12	Bumper	Urethane rubber	
13	Piston nut	Carbon steel	Zinc chromate (ø6 to ø15: not available)
14	Type C retaining ring for hole	Carbon tool steel	Phosphate coated
15	Attachment ring	Aluminum alloy	Chromate
16	Type C retaining ring for shaft	Hard steel wire	
17	Magnetic shielding plate	Rolled steel plate	Chromated (ø6, ø10: not available)
18a	Switch rail (both sides piping)	Aluminum alloy	White anodized
18b	Switch rail (centralized piping)	Aluminum alloy	White anodized
19	Magnet	—	
20	Hexagon socket head plug	Chromium steel	Nickel plated
21	Steel balls	Chromium steel	ø40 Hexagon socket head plug ø20, ø50, ø63 None
22	Hexagon socket head screw	Chromium steel	Nickel plated
23	Hexagon socket head set screw	Chromium steel	Nickel plated

No.	Description	Material	Note
24 Note 2)	Cylinder tube Gasket	NBR	
25 Note 2)	Wear ring A	Special resin	ø6: not available
26 Note 2)	Wear ring B	Special resin	
27 Note 2)	Wear ring C	Special resin	
28 Note 2)	Piston seal	NBR	
29 Note 2)	Lubretainer	Special resin	ø6: not available
30 Note 2)	Switch rail gasket	NBR	Both sides piping type: None

### Replacement Parts/Seal Kit

Bore size (mm)	Kit no.	Contents
6	CY3R6-PS	Set of nos. above 24, 26, 27, 29
10	CY3R10-PS	Set of nos. above 24, 26, 27, 28, 29, 30
15	CY3R15-PS	
20	CY3R20-PS	
25	CY3R25-PS	Set of nos. above 24, 26, 27, 28, 29, 30
32	CY3R32-PS	
40	CY3R40-PS	
50	CY3R50-PS	
63	CY3R63-PS	

Note1) Seal kits are the same for both the both sides piping type and the centralized piping type.

Note2) Seal kits are sets consisting of numbers 24 through 30. Order using the kit number corresponding to each bore size.

Note3) For replacement of the ø10 wear ring A, contact SMC or your nearest sales representative.

\* Seal kit includes a grease pack (ø6, ø10: 5 and 10 g, ø15 to ø63: 10 g). Order with the following part number when only the grease pack is needed.

**Grease pack part number for ø6, ø10: GR-F-005 (5 g)** For external sliding sections

**GR-S-010 (10 g)** For tubing interior

**Grease pack part number for ø15 to ø63: GR-S-010 (10 g)**



## Construction

### Centralized piping type

#### CY3RG10

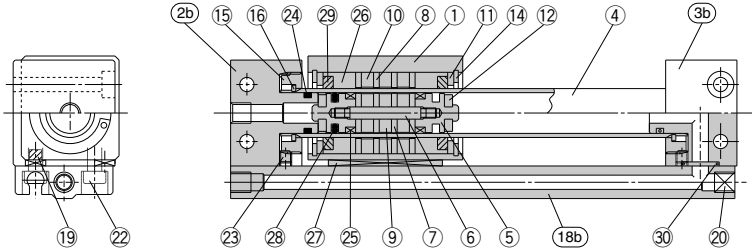

#### CY3RG15 to 63

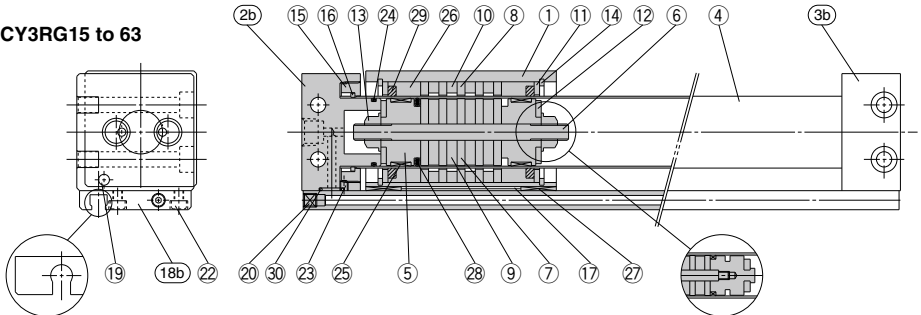

#### CY3RG15, 20

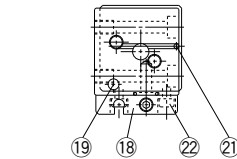

#### CY3RG15

#### CY3RG15

## Switch Rail Accessory

**CYR 15 E B (N) - 100**

Bore size

Cylinder piping type

Nil	Centralized piping (CY3RG)
B	Both sides piping (CY3R)

Note) Only "B" for ø6.

Auto switch type  
(ø20 only)

Nil	For reed switch
N	For solid state switch

Stroke

### Switch Rail Accessory Kit

Bore size (mm)	Kit no.		Contents
	Both sides piping	Centralized piping	
6	CYR6EB-□	—	Numbers (18a), (18b), 19, 22, 27 above
10	CYR10EB-□	CYR10E-□	Numbers (18a), (18b), 19, 20, 22, 27 above
15	CYR15EB-□	CYR15E-□	Numbers 17, (18a), (18b), 20, 22, 27 above Note 2)
20	For reed switch	CYR20EB-□	CYR20E-□
	For solid state switch	CYR20EBN-□	CYR20EN-□
25	CYR25EB-□	CYR25E-□	Numbers 17, (18a), (18b), 19, 20, 22, 27 above
32	CYR32EB-□	CYR32E-□	
40	CYR40EB-□	CYR40E-□	
50	CYR50EB-□	CYR50E-□	
63	CYR63EB-□	CYR63E-□	

Note 1) □ indicates the stroke.

Note 2) A magnet is already built in for ø15.

Note 3) (18a) is attached on both sides piping.

Note 4) (18b) and 20 are attached on centralized piping.

CY3B  
CY3R

CY1S

CY1L

CY1H

CY1F

CYP

D-□

-X□

Technical  
Data





# CY3B/CY3R Series Auto Switch Mounting

## Auto Switch Proper Mounting Position for Stroke End Detection

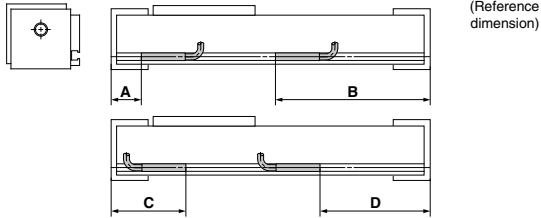

### Auto Switch Proper Mounting Position

ø6 to ø20

(mm)

Auto switch model Bore size (mm)	A			B			C			D		
	D-A9□	D-M9□ D-M9□W D-M9□A	D-A9□	D-M9□ D-M9□W D-M9□A	D-A9□	D-M9□ D-M9□W D-M9□A	D-A9□	D-M9□ D-M9□W D-M9□A	D-A9□	D-M9□ D-M9□W D-M9□A		
6	26	30	46	42	46	42	26	30				
10	28	32	48	44	48	44	—	32				
15	17.5	21.5	76.5	72.5	—	—	56.5	60.5				
20	19.5	23.5	87.5	83.5	39.5	35.5	67.5	71.5				

Note 1) Auto switches cannot be installed in Area C in the case of ø15.

Note 2) D-A9□ type cannot be mounted on the section D of ø10.

Note 3) The above values are a guideline of the auto switch mounting position when detected at the stroke end. Adjust the auto switch after confirming the operating conditions in the actual setting.

Note 4) D-Z7□ and D-Y□ types cannot be mounted.

ø25 to ø63

(mm)

Auto switch model Bore size (mm)	A				B				C				D			
	D-A9□	D-M9□ D-M9□W D-M9□A	D-Z7□ D-Z80 D-Y59□ D-Y7P D-Y7W D-Y7BA	D-A9□	D-M9□ D-M9□W D-M9□A	D-Z7□ D-Z80 D-Y59□ D-Y7P D-Y7W D-Y7BA	D-A9□	D-M9□ D-M9□W D-M9□A	D-Z7□ D-Z80 D-Y59□ D-Y7P D-Y7W D-Y7BA	D-A9□	D-M9□ D-M9□W D-M9□A	D-Z7□ D-Z80 D-Y59□ D-Y7P D-Y7W D-Y7BA	D-A9□	D-M9□ D-M9□W D-M9□A	D-Z7□ D-Z80 D-Y59□ D-Y7P D-Y7W D-Y7BA	
25	19	23	18	98	94	99	42	38	43	75	79	74				
32	22.5	26.5	21.5	107.5	103.5	108.5	45.5	41.5	46.5	84.5	88.5	83.5				
40	24.5	28.5	23.5	123.5	119.5	124.5	47.5	43.5	48.5	100.5	104.5	99.5				
50	28.5	32.5	27.5	147.5	143.5	148.5	51.5	47.5	52.5	124.5	128.5	123.5				
63	30.5	34.5	29.5	157.5	153.5	158.5	53.5	49.5	54.5	134.5	138.5	133.5				

Note 1) 50 mm is the minimum stroke available with 2 auto switches mounted.

Note 2) Figures in the table above are used as a reference when mounting the auto switches for stroke end detection. In the case of actually setting the auto switches, adjust them after confirming their operation.

Note 3) Auto switch brackets are required when ordering D-A9□/M9□/M9□W/M9□A types and cylinders separately. (Refer to the auto switch mounting bracket: part no. on page 1479.)

## Auto Switch Operation Range

Auto switch model	Bore size (mm)								
	6	10	15	20	25	32	40	50	63
D-A9□	8	11	8	6	6	7	9	8	8
D-M9□ D-M9□W D-M9□A	4.5	6.5	4.5	5	5	5.5	5.5	6.5	7
D-Z7□/Z80	—	—	—	—	9	9	11	9	10
D-Y59□/Y7P/Y7□W/Y7BA	—	—	—	—	5	5	6	6	6

\* The auto switches cannot be mounted in some cases.

\* Since the operating range is provided as a guideline including hysteresis, it cannot be guaranteed (assuming approximately ±30% dispersion). It may vary substantially depending on an ambient environment.

## Auto Switch Mounting Bracket/Part No.

Auto switch model	Bore size (mm)
	D-A9□ D-M9□ D-M9□W D-M9□A
	BMG2-012

D-A9□/M9□/M9□W/M9□A

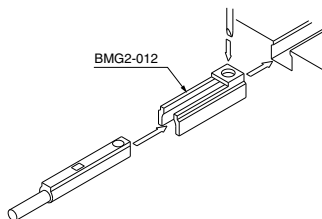

Other than the applicable auto switches listed in "How to Order", the following auto switches can be mounted. For detailed specifications, refer to pages 1575 to 1701.

Type	Model	Electrical entry	Features	Applicable bore size
Reed auto switch	D-Z73, Z76	Grommet (In-line)	—	ø25 to ø63
	D-Z80		Without indicator light	
Solid state auto switch	D-Y59A, Y59B, Y7P	Grommet (In-line)	—	
	D-Y7NW, Y7PW, Y7BW		Diagnostic indication (2-color display)	
	D-Y7BA		Water resistant (2-color display)	

\* With pre-wired connector is also available in solid state auto switches. For specifications, refer to pages 1648 and 1649.

\* Normally closed (NC = b contact) solid state switches (D-M9□E(V)/Y7G/Y7H) are also available. For details, refer to pages 1592-1 and 1595.

\* Applicable bore sizes are ø25 to ø63.

**CY3B**  
**CY3R**

**CY1S**

**CY1L**

**CY1H**

**CY1F**

**CYP**

**D-□**

**-X□**

Technical  
Data

# CY3B/CY3R Series

## Made to Order: Individual Specifications 1

Please contact SMC for detailed dimensions, specifications and lead times.



### Applicable Series

No.	Symbol	Specifications/Description	Basic type <b>CY3B</b>	Direct mount type <b>CY3R</b>
1	-X116	Hydro specifications	●(ø25 to ø63)	●(ø25 to ø63)
2	-X132	Air supply port relocated in axial direction	●(ø6 to ø63)	—
3	-X160	High speed specifications	●(ø20 to ø63)	●(ø20 to ø63)
4	-X168	Helical insert thread specifications	●(ø20 to ø63)	—
5	-X206	Added mounting tap positions for slider	●(ø6 to ø63)	—
6	-X210	Non-lubricated exterior specifications	●(ø6 to ø63)	—
7	-X322	Outside of cylinder tube with hard chrome plated	●(ø15 to ø63)	●(ø15 to ø63)
8	-X324	Non-lubricated exterior specifications (with dust seal)	●(ø10 to ø63)	—
9	-X1468	Interchangeable with CY1□6	●(ø6)	●(ø6)

## 1 Hydro Specifications

Symbol

**-X116**

This type is applicable for precision constant speed feed, intermediate stop and skip feed.

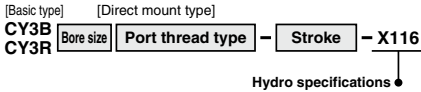

### Specifications

Type	Basic type, Direct mount type
<b>Bore size</b>	Basic type CY3B25 to 63, CY3R25 to 63
<b>Fluid</b>	Turbine oil
<b>Piston speed</b>	15 to 300mm/s

Note) Piping is from each plate on both sides.

## 2 Air Supply Port Relocated in Axial Direction

Symbol

**-X132**

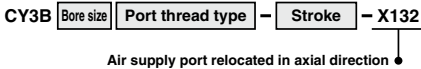

The air supply port has been changed to an axial position on the head cover.

### Specifications

Applicable series	<b>CY3B</b>
<b>Bore size</b>	ø6 to ø63

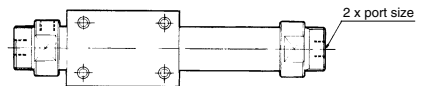

The port size is the same as the standard type.

**3 High Speed Specifications** Symbol  
**-X160**

CY3B Bore size Port thread type - Stroke - **X160**

High speed specifications ●

This makes a high speed piston drive of 1,500 mm/s possible (basic type, without load), but it is not applicable for all conditions. Consult with SMC for the operating conditions, etc.

**Specifications**

Applicable series	CY3B/CY3R
Bore size	ø20 to ø63
Piston speed (no load)	1500 mm/s (MAX)

- Note 1) When operating this cylinder at high speed, a shock absorber must be provided.  
 Note 2) For the CY3R, only the piping on both sides can be made.  
 Note 3) The piston speed may vary depending on the operating conditions. For details, contact SMC or your nearest sales representative.  
 Note 4) Speed tends to decrease over a period of time depending on the operating conditions. Apply grease periodically if necessary.

**5 Added Mounting Tap Positions for Slider** Symbol  
**-X206**

CY3B Bore size Port thread type - Stroke - **X206**

Added mounting tap positions for slider ●

Mounting taps have been added on the surface opposite the standard positions.

**Specifications**

Applicable series	CY3B
Bore size	ø6 to ø63

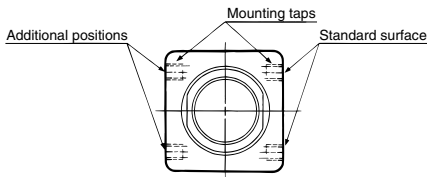

\* Dimensions are the same as the standard product.

**4 Helical Insert Thread Specifications** Symbol  
**-X168**

CY3B Bore size Port thread type - Stroke - **X168**

Helical insert thread specifications ●

Helical insert thread is used for standard mounting thread.

**Specifications**

Applicable series	CY3B
Bore size	CY3B: ø20 to ø63

**6 Non-lubricated Exterior Specifications** Symbol  
**-X210**

CY3B Bore size Port thread type - Stroke - **X210**

Non-lubricated exterior specifications ●

Suitable for environments where oil is not tolerated. A scraper is not installed. A separate version -X324 (with a felt dust seal) is available in cases in which dust, etc. is dispersed throughout the environment.

**Specifications**

Applicable series	CY3B
Bore size	ø6 to ø63

**Construction**

CY3B (Basic type)

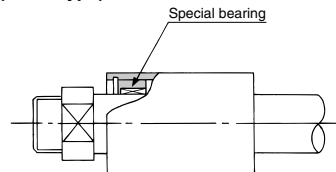

- CY3B**
- CY3R**
- CY1S**
- CY1L**
- CY1H**
- CY1F**
- CYP**

- D-□**
- X□**
- Technical Data

# CY3B/CY3R Series

## Made to Order: Individual Specifications 2

Please contact SMC for detailed dimensions, specifications and lead times.



### 7 Outside of Cylinder Tube with Hard Chrome Plated Symbol **-X322**

CY3B Bore size Port thread type — Stroke — X322

Outside of cylinder tube with hard chrome plated

The cylinder tube outer circumference is plated with hard chrome, which further reduces bearing abrasion.

\* Be sure to install a shock absorber to the stroke end.

Note 1) The maximum stroke is 3,500 st, or the maximum stroke for the standard type.

CY3R is compatible with the maximum stroke for the standard type.

Note 2) When exceeding 2,000 strokes, contact SMC separately.

#### Specifications

Applicable series	Bore size (mm)
*CY3B-3R	ø15 to ø63

#### Construction/Dimensions

##### CY3B

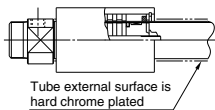

##### CY3R

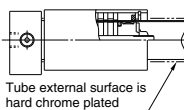

### 8 Non-lubricated Exterior Specifications (with Dust Seal) Symbol **-X324**

CY3B Bore size Port thread type — Stroke — X324

Non-lubricated exterior specifications (with dust seal)

Non-lubricated exterior type with a felt dust seal on the cylinder body.

#### Specifications

Applicable series	Bore size (mm)
CY3B	ø10 to ø63

#### Construction

##### CY3B (Basic type)

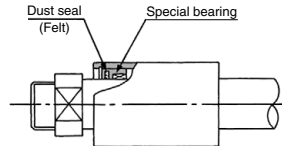

### 9 Interchangeable with CY1□6 Symbol **-X1468**

CY3B Bore size Port thread type — Stroke — X1468

Interchangeable with CY1□6

Can be interchanged with CY1□6.





# CY3B/CY3R Series

## Specific Product Precautions 1

Be sure to read this before handling the products.

Refer to back page 50 for Safety Instructions and pages 3 to 12 for Actuator and Auto Switch Precautions.

### Handling

#### ⚠ Warning

1. Pay attention to the space between the head cover and the body.

Take sufficient care to avoid getting your hands or fingers caught when the cylinder is operated.

2. Do not apply a load to a cylinder which is greater than the allowable value stated in the Model Selection.

Applying an improper load may cause malfunctions.

3. Do not use the cylinder in an environment where the cylinder is expose to moisture, adhesive foreign matter, dust or liquid such as water or cutting fluid.

If the cylinder is used in an environment where the lubrication of the cylinders sliding parts is compromised, please consult SMC.

4. When applying grease to the cylinder, use the grease that has already been applied to the product. Contact SMC for available grease packs.

### Mounting

#### ⚠ Caution

1. Take care to avoid nicks or other damage on the outside surface of the cylinder tube.

This can lead to damage of the wear ring and lubretainer, which in turn can cause malfunction.

2. Take care regarding rotation of the external slider.

Even when the rotation is controlled by connecting the external slider to other shaft (linear guide, etc.), keep it in the floating connection status.

3. Do not operate with the magnetic coupling out of position.

In case the magnetic coupling is out of position, push the external slider back into the correct position by hand at the end of the stroke (or correct the piston slider with air pressure).

4. The cylinder is mounted with bolts through the mounting holes in the end covers. Be sure they are tightened securely. (CY3R)

5. If gaps occur between the mounting surface and the end covers when mounting with bolts, perform shim adjustment using spacers, etc. so that there is no unreasonable stress. (CY3R)

6. Be sure that both end covers are secured to the mounting surface before operating the cylinder.

Avoid operation with the external slider secured to the surface.

### Mounting

#### ⚠ Caution

7. Do not apply a lateral load to the external slider.

When a load is mounted directly to the cylinder, variations in the alignment of each shaft center cannot be assimilated, which results in the generation of a lateral load that can cause malfunction. (Figure 1) The cylinder should be operated using a connection method which allows for assimilation of shaft alignment variations and deflection due to the cylinder's own weight. A drawing of a recommended mounting is shown in Figure 2.

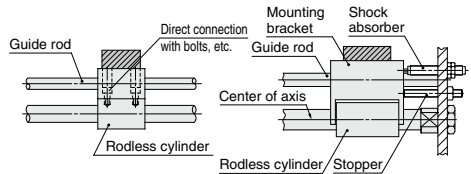

Variations in the load and cylinder shaft alignment cannot be assimilated, resulting in malfunction.

Shaft alignment variations are assimilated by providing clearance for the mounting bracket and cylinder. Moreover, the mounting bracket is extended above the cylinder shaft center, so that the cylinder is not subjected to moment.

Figure 1. Incorrect mounting

Figure 2. Recommended mounting

Note) The drawing shows the CY3B series.

8. Use caution regarding the allowable load mass when operating in a vertical direction.

The allowable load mass when operating in a vertical direction (reference values on page 1466) is determined by the model selection method, however, if a load greater than the allowable value is applied, the magnetic coupling may break and there is a possibility of dropping the load. When using this type of application, contact SMC regarding the operating conditions (pressure, load, speed, stroke, frequency, etc.).

9. Careful alignment is necessary when connecting to a load having an external guide mechanism.

As the stroke becomes longer, variations in the center axis become larger. Consider using a connection method (floating mechanism) that is able to absorb these variations. Furthermore, use the special floating brackets (XC57) which have been provided for the CY3B and CY3R series (page 1836).

CY3B  
CY3R

CY1S

CY1L

CY1H

CY1F

CYP

D-□

-X□

Technical  
Data



# CY3B/CY3R Series

## Specific Product Precautions 2

Be sure to read this before handling the products.

Refer to back page 50 for Safety Instructions and pages 3 to 12 for Actuator and Auto Switch Precautions.

### Disassembly & Maintenance

#### ⚠ Warning

1. Use caution as the attractive power of the magnets is very strong.

When removing the external slider and piston slider from the cylinder tube for maintenance, etc., handle with caution, since the magnets installed in each slider have very strong attractive power.

#### ⚠ Caution

1. When reattaching the head covers after disassembly, confirm that they are tightened securely. (CY3B)

When disassembling, hold the wrench flat section of one head cover with a vise, and remove the other cover using a spanner or adjustable angle wrench on its wrench flat section. When retightening, first coat with Locktight (No. 542 red), and retighten 3 to 5° past the original position prior to removal.

2. Special tools are necessary for disassembly. (CY3R)

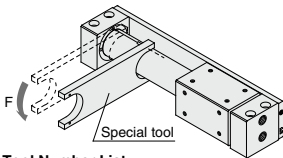

#### Special Tool Number List

Part no.	Applicable bore size (mm)
CYRZ-V	6, 10, 15, 20
CYRZ-W	25, 32, 40
CYRZ-X	50
CYRZ-Y	63

3. Use caution when taking off the external slider, as the piston slider will be directly attracted to it.

When removing the external slider or piston slider from the cylinder tube, first force the sliders out of their magnetically coupled positions and then remove them individually while there is no longer any holding force. If they are removed when still magnetically coupled, they will be directly attracted to one another and will not come apart.

4. Do not disassemble the magnetic components (piston slider, external slider).

This can cause a loss of holding force and malfunction.

5. When disassembling to replace the seals and wear ring, refer to the separate disassembly instructions.

### Disassembly & Maintenance

#### ⚠ Caution

6. Note the direction of the external slider and piston slider.

Since the external slider and piston slider are directional for  $\phi 6$  and  $\phi 10$ , refer to the figures below when performing disassembly or maintenance. Put the external slider and piston slider together, and insert the piston slider into the cylinder tube so that they will have the correct positional relationship as shown in Figure 3. If they align as shown in Figure 4, insert the piston slider after turning it around 180°. If the direction is not correct, it will be impossible to obtain the specified holding force.

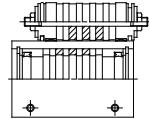
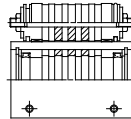

Figure 3. Correct position

Figure 4. Incorrect position

For  $\phi 6$  and  $\phi 10$