

Low Profile Guide Type

CY1F Series

ø10, ø15, ø25



CY3B
CY3R

CY1S

CY1L

CY1H

CY1F

CYP

D-□

-X□

Technical
Data

“Low profile”, “Compact body” and “Lightweight”

Low profile

Height reduced by 29%

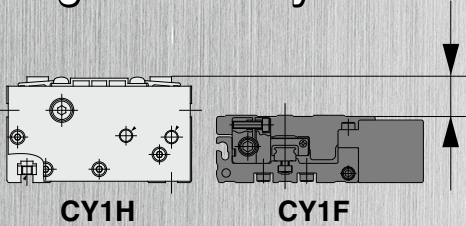

Height	mm		
Series	ø10	ø15	ø25
CY1F	28	34	46
CY1H	39.5	46	63

Compact body

Overall length reduced by 31%

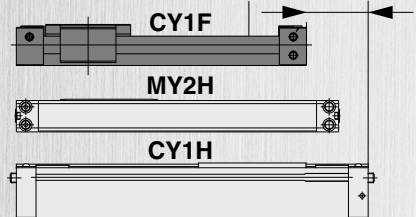

Overall length	mm		
Series	ø10	ø15	ø25
CY1F	198	205	240
CY1H	225	294	350
MY2H	—	260	310

* For 100 mm stroke cylinder

Overall length reduced by 22% compared to the MY2H series

Various concentrated piping ports are available.

Piping port position can be specified using a part number.
3 types of piping screws are available.

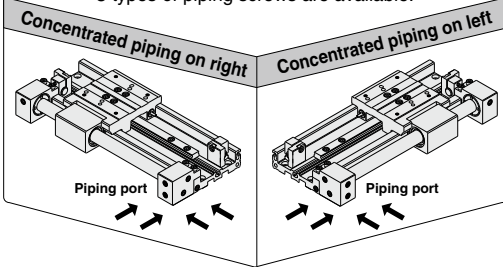

4 types of stroke adjustment are available.

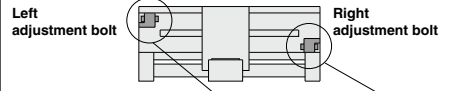

	Left adjustment bolt	Right adjustment bolt
Both sides standard type	-1 mm to 0 mm	-1 mm to 0 mm
AL type	-25 mm to 0 mm	-1 mm to 0 mm
AR type	-1 mm to 0 mm	-25 mm to 0 mm
A type	-25 mm to 0 mm	-25 mm to 0 mm

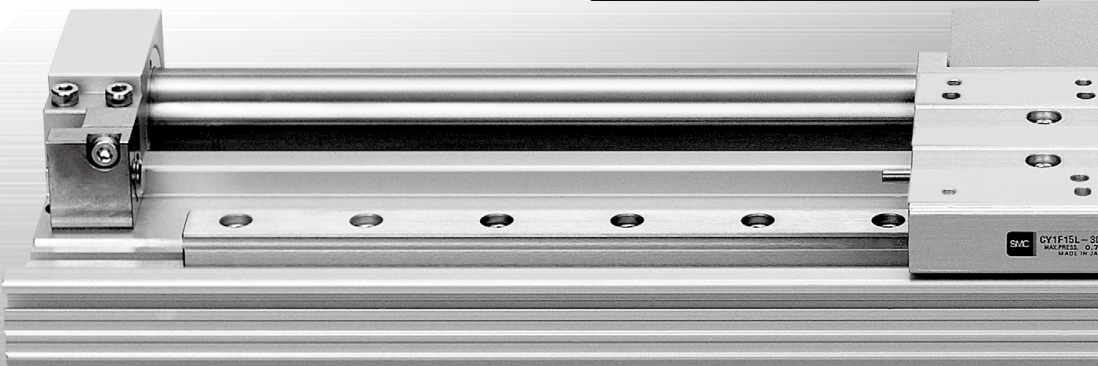

Lightweight **Weight reduced by 50%**

Weight kg			
Series	ø10	ø15	ø25
CY1F	0.7	1.1	2.5
CY1H	1.0	2.2	4.6
MY2H	—	1.3	3.2

* For 100 mm stroke cylinder

Available bore sizes ø10, 15, 25

Model	Bore size (mm)	Standard stroke (mm)											Maximum stroke	Cushion	Piping directions			
		50	100	150	200	250	300	350	400	450	500	550				600		
CY1F	10	●	●	●	●	●	●	●	●	●	●	●	●	●	●	500	Built-in shock absorber	Concentrated piping on right Concentrated piping on left
	15	●	●	●	●	●	●	●	●	●	●	●	●	●	750			
	25	●	●	●	●	●	●	●	●	●	●	●	●	●	1200			

Accumulated dust on the guide can be removed easily without an end cover.

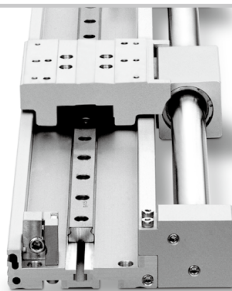

The cylinder and guide are integrated.

The cylinder portion can be replaced without interfering with the workpiece.

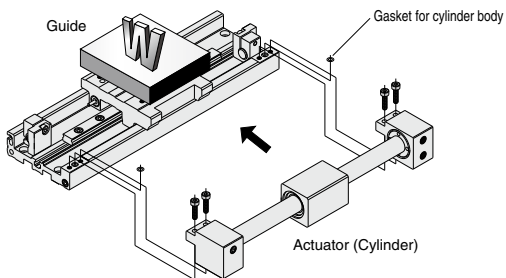

CY3B
CY3R

CY1S

CY1L

CY1H

CY1F

CYP

D-□

-X□

Technical Data

CY1F Series Model Selection

The following are the steps for selection of the CY1F series best suited to your application.

Standards for Tentative Model Selection

Cylinder model	Guide model	Standard for guide selection	Graph for related allowable values
CY1F	Linear guide (Single axis)	Slide table accuracy approx. ±0.05 mm or less	Refer to page 1547.

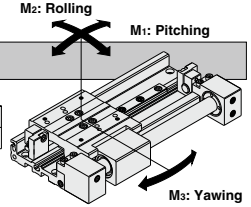

Selection Flow Chart

Es: Allowable kinetic energy for intermediate stop by pneumatic circuit (J)
Ps: Operating pressure limit for intermediate stop by external stopper, etc.
 Limit value (MPa)

Pv: Maximum operating pressure in vertical operation (MPa)
mv: Maximum allowable load mass in vertical operation (kg)
 α : Load factor

$$\Sigma\alpha = \frac{\text{Load mass (m)}}{\text{Maximum allowable load (m}_{\text{max}})} + \frac{\text{Static moment (M)}}{\text{Allowable static moment (M}_{\text{max}})} + \frac{\text{Dynamic moment (Me)}}{\text{Allowable dynamic moment (Me}_{\text{max}})}$$

E: Load kinetic energy (J)

$$E = \frac{m}{2} \left(\frac{Va}{1000} \right)^2$$

Operating Conditions

- m: Load mass (kg)
- P: Operating pressure (MPa)
- L: Center of gravity of the workpiece (mm)
- Mode of operation (Horizontal, Inclination, Vertical)
- Va: Average speed

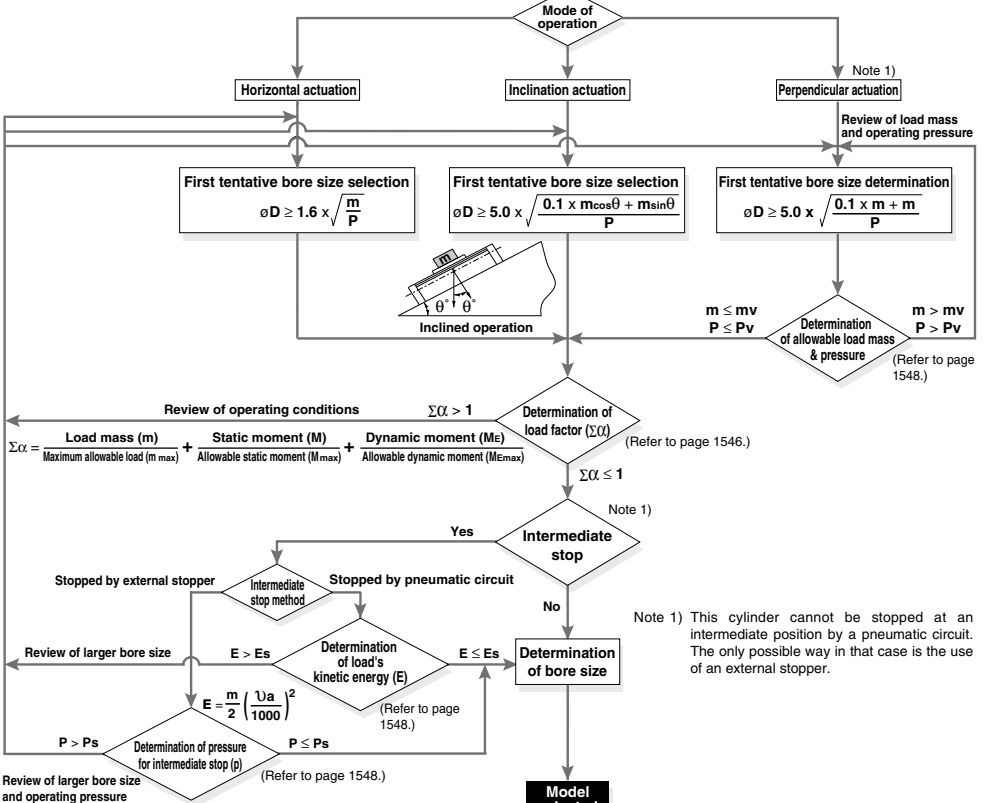

Types of Moment Applied on Rodless Cylinders

Multiple moments may be generated depending on the mounting orientation load and position of the center of gravity.

Coordinates and Moments

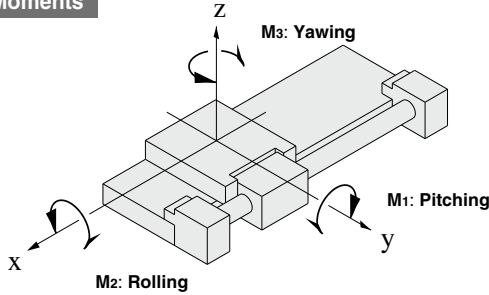

Static Moment

Horizontal mounting

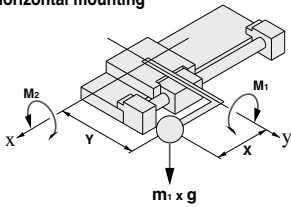

Ceiling mounting

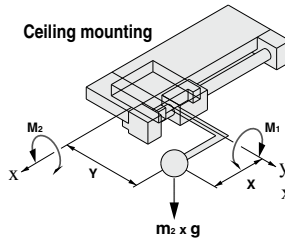

Wall mounting

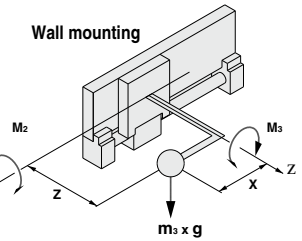

Vertical mounting

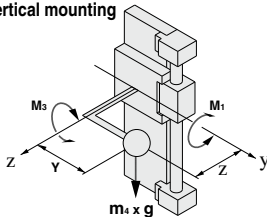

g: Gravitational acceleration

Mounting orientation	Horizontal	Ceiling	Wall	Vertical
Static load m	m_1	m_2	m_3	m_4
Static moment				
M_1	$m_1 \times g \times X$	$m_2 \times g \times X$	—	$m_4 \times g \times Z$
M_2	$m_1 \times g \times Y$	$m_2 \times g \times Y$	$m_3 \times g \times Z$	—
M_3	—	—	$m_3 \times g \times X$	$m_4 \times g \times Y$

CY3B
CY3R

CY1S

CY1L

CY1H

CY1F

CYP

D-

-X

Technical Data

Dynamic Moment

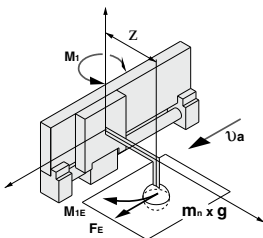

g: Gravitational acceleration, U_a : Average speed

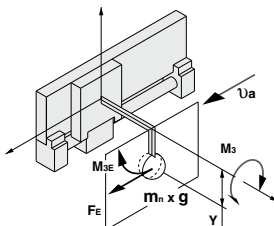

Mounting orientation	Horizontal	Ceiling	Wall	Vertical
Dynamic load F_E	$\frac{1.4}{100} \times U_a \times m_n \times g$			
Dynamic moment				
M_{1E}	$\frac{1}{3} \times F_E \times Z$			
M_{2E}	Dynamic moment M_{2E} is not generated.			
M_{3E}	$\frac{1}{3} \times F_E \times Y$			

Note) Regardless of the mounting orientation, dynamic moment is calculated with the formulas above.

Maximum Allowable Moment/Maximum Allowable Load

Model	Bore size (mm)	Maximum allowable moment (N-m)			Maximum allowable load (kg)			
		M1	M2	M3	m1	m2	m3	m4
CY1F	10	1	2	1	2	2	2	1.4
	15	1.5	3	1.5	5	5	5	2
	25	14	20	14	12	12	12	12

The above values are the maximum allowable values for moment and load. Refer to each graph regarding the maximum allowable moment and maximum allowable load for a particular piston speed.

Maximum Allowable Moment

Select the moment from within the range of operating limits shown in the graphs. Note that the maximum allowable load value may sometimes be exceeded even within the operating limits shown in the graphs. Therefore, also check the allowable load for the selected conditions.

Load (kg)

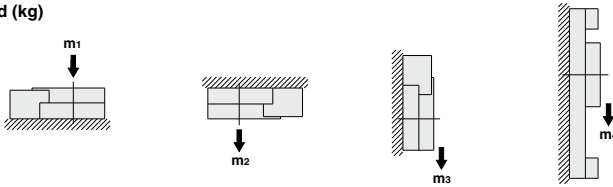

Moment (N-m)

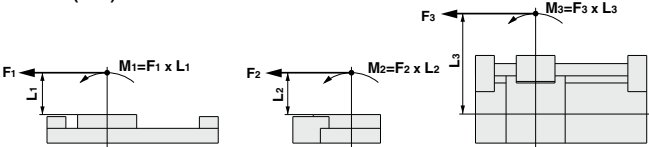

<Calculation guide load factor>

1. Maximum allowable load (1), static moment (2), and dynamic moment (3) (at the time of impact with stopper) must be examined for the selection calculations.

* To evaluate, use \bar{U} a (average speed) for (1) and (2), and U (impact speed $U = 1.4\bar{U}$ a) for (3). Calculate m max for (1) from the maximum allowable load graph (m_1, m_2, m_3, m_4) and M max for (2) and (3) from the maximum allowable moment graph (M_1, M_2, M_3).

$$\text{Sum of guide load factors } \Sigma\alpha = \frac{\text{Load mass [m]}}{\text{Maximum allowable load [m max]}} + \frac{\text{Static moment [M] Note 1}}{\text{Allowable static moment [Mmax]}} + \frac{\text{Dynamic moment [ME] Note 2}}{\text{Allowable dynamic moment [MEmax]}} \leq 1$$

Note 1) Moment caused by the load, etc., with cylinder in resting condition.
 Note 2) Moment caused by the impact load equivalent at the stroke end (at the time of impact with stopper).
 Note 3) Depending on the shape of the workpiece, multiple moments may occur. When this happens, the sum of the load factors ($\Sigma\alpha$) is the total of all such moments.

2. Reference formulas [Dynamic moment at impact]

Use the following formulas to calculate dynamic moment when taking stopper impact into consideration.

- m : Load mass (kg)
- F : Load (N)
- F_E : Load equivalent to impact (at impact with stopper) (N)
- \bar{U} a: Average speed (mm/s)
- M : Static moment (N-m)
- U : Impact speed (mm/s)
- L : Distance to the load's center of gravity (m)
- M_E : Dynamic moment (N-m)
- g : Gravitational acceleration (9.8 m/s²)

$$U = 1.4\bar{U}a \text{ (mm/s)} \quad F_E = \frac{1.4}{100} \cdot \bar{U}a \cdot g \cdot m \text{ Note 4)}$$

$$\therefore M_E = \frac{1}{3} \cdot F_E \cdot L = 0.05\bar{U}a \cdot m \cdot L \text{ (N-m) Note 5)}$$

Note 4) $\frac{1.4}{100} \cdot \bar{U}a$ is a dimensionless coefficient for calculating impact force.

Note 5) Average load coefficient ($= \frac{1}{3}$):
 This coefficient is for averaging the maximum load moment at the time of stopper impact according to service life calculations.

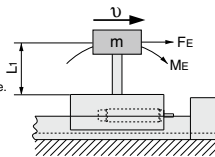

3. Refer to pages 1549 and 1550 for detailed selection procedures.

Maximum Allowable Load

Select the load from within the range of limits shown in the graphs. Note that the maximum allowable moment value may sometimes be exceeded even within the operating limits shown in the graphs. Therefore, also check the allowable moment for the selected conditions.

(1) CY1F/M₁

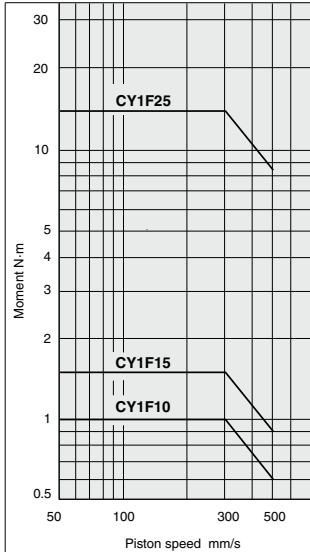

(2) CY1F/M₂

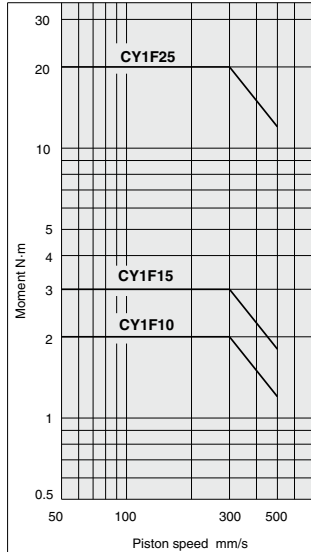

(3) CY1F/M₃

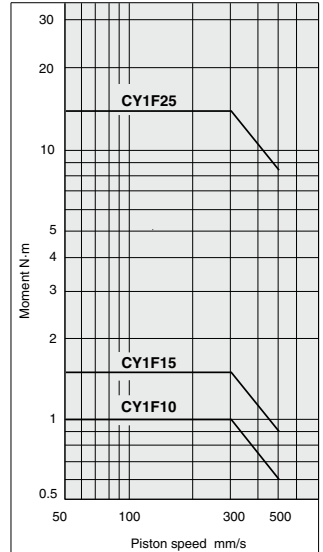

(4) CY1F/m₁

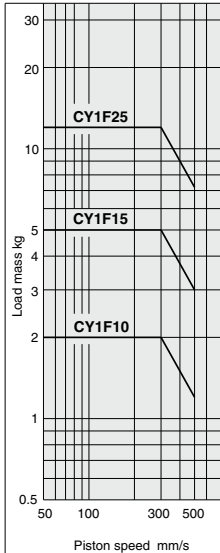

(5) CY1F/m₂

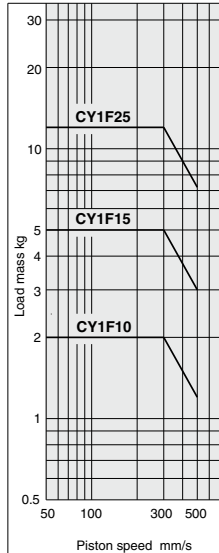

(6) CY1F/m₃

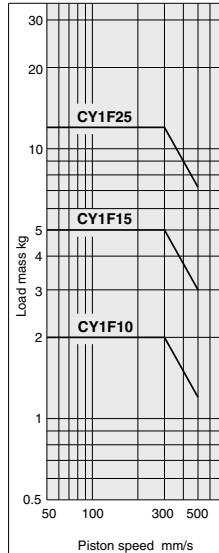

(7) CY1F/m₄

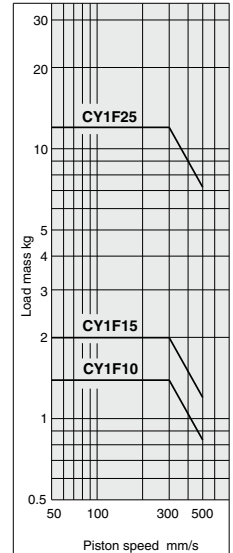

CY3B
CY3R

CY1S

CY1L

CY1H

CY1F

CYP

D-

-X

Technical
Data

Precautions at Vertical Operation and Intermediate Stop

Vertical Actuation

1. Vertical operation

In vertical operation, observe the maximum load mass and the maximum operating pressure shown in the table below to prevent a drop due to slipping off of magnet couplings.

Caution

If the maximum load mass or maximum operating pressure is exceeded, it will cause the magnet coupling to slip off.

Bore size (mm)	Maximum load weight mv (kg)	Maximum operating pressure Pv (MPa)
10	1.4	0.55
15	2.0	0.65
25	12	0.65

When the cylinder is mounted vertically or sideling, a slider may move downwards due to the self-weight or workpiece mass. If an accurate stopping position is required at the stroke end or the middle of stroke, use an external stopper to secure the accurate positioning.

Intermediate Stop

1. Intermediate stop by external stopper or stroke adjustment with adjustment bolt.

Observe the maximum pressure limit in the table below in case of intermediate stop by an external stopper or stroke adjustment with the attached adjustment bolt.

Caution

Be careful if the operating pressure limit is exceeded, it will cause the magnet coupling to slip off.

Bore size (mm)	Holding force (N)	Operating pressure limit for intermediate stop Ps (MPa)
10	53.9	0.55
15	137	0.65
25	363	0.65

2. The load is stopped by pneumatic circuit.

Observe the maximum kinetic energy in the table below in case the load is stopped at an intermediate position by a pneumatic circuit. Note that intermediate stop by a pneumatic circuit is not available in vertical operation.

Caution

If the allowable kinetic energy is exceeded, it will cause the magnet coupling to slip off.

Bore size (mm)	Allowable kinetic energy for intermediate stop Es (J)
10	0.03
15	0.13
25	0.45

Selection Calculation

The selection calculation finds the load factors ($\Sigma\alpha_n$) of the items below, where the total (α_n) does not exceed 1.

$$\Sigma\alpha_n = \alpha_1 + \alpha_2 + \alpha_3 \leq 1$$

Item	Load factor α_n	Note
1. Maximum load mass	$\alpha_1 = m/m_{\max}$	Review m m_{\max} is the maximum load mass at υ_a
2. Static moment	$\alpha_2 = M/M_{\max}$	Review M_1, M_2, M_3 M_{\max} is the allowable moment at υ_a
3. Dynamic moment	$\alpha_3 = M_E/M_{E\max}$	Review M_{1E}, M_{2E}, M_{3E} $M_{E\max}$ is the allowable moment at υ

υ : Collision speed υ_a : Average speed

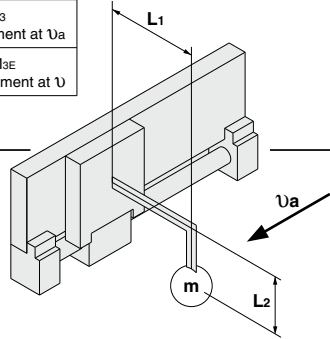

Calculation Example 1

Operating Conditions

Cylinder: **CY1F15**
 Terminal butter mechanism: Standard (shock absorber)
 Mounting: Wall mounting
 Speed (average) : $\upsilon_a = 300$ [mm/s]
 Load mass: $m = 0.5$ [kg] (excluding weight of arm section)
 $L_1 = 50$ [mm]
 $L_2 = 40$ [mm]

Item	Load factor α_n	Note
1. Load mass 	$\alpha_1 = m/m_{\max}$ $= 0.5/5$ $= 0.1$	Investigate m . Find the value of m_{\max} at 300 mm/s in Graph (6) for m_3 .
2. Static moment 	$M_2 = m \times g \times L_1$ $= 0.5 \times 9.8 \times 0.05$ $= 0.245$ [N·m] $\alpha_2 = M_2/M_2 \max$ $= 0.245/3$ $= 0.082$	Investigate M_2 . M_1 and M_3 are not required because they are not generated. Find the value of $M_2 \max$ at 300 mm/s in Graph (2).
3. Dynamic moment 	$M_{1E} = 1/3 \times F_E \times L_1$ $(F_E = 1.4/100 \times \upsilon_a \times g \times m)$ $= 0.05 \times \upsilon_a \times m \times L_1$ $= 0.05 \times 300 \times 0.5 \times 0.05$ $= 0.375$ [N·m] $\alpha_{3A} = M_{1E}/M_{1E \max}$ $= 0.375/1.07$ $= 0.350$	Investigate M_{1E} . Find the collision speed υ . $\upsilon = 1.4 \times \upsilon_a$ $= 1.4 \times 300$ $= 420$ [mm/s] Find the value of $M_{E1 \max}$ at 420 mm/s in Graph (1).
	$M_{3E} = 1/3 \times F_E \times L_2$ $(F_E = 1.4/100 \times \upsilon_a \times g \times m)$ $= 0.05 \times \upsilon_a \times m \times L_2$ $= 0.05 \times 300 \times 0.5 \times 0.04$ $= 0.3$ [N·m] $\alpha_{3B} = M_{3E}/M_{3E \max}$ $= 0.3/1.07$ $= 0.28$	Investigate M_{3E} . From above, find the value of $M_{3E \max}$ at 420 mm/s in Graph (3).

From above,

$$\Sigma\alpha_n = \alpha_1 + \alpha_2 + \alpha_{3A} + \alpha_{3B} = 0.1 + 0.082 + 0.35 + 0.28 = 0.812$$

From $\Sigma\alpha_n = 0.812 \leq 1$, it is applicable.

CY3B
CY3R

CY1S

CY1L

CY1H

CY1F

CYP

D-□

-X□

Technical
Data

Calculation Example 2

Operating Conditions

Cylinder: CY1F25
 Terminal buffer mechanism: Standard (shock absorber)
 Mounting: Vertical mounting
 Speed (average): $\upsilon_a = 300$ [mm/s]
 Load mass: $m = 3$ [kg] (excluding weight of arm section)
 $L_1 = 50$ [mm]
 $L_2 = 40$ [mm]

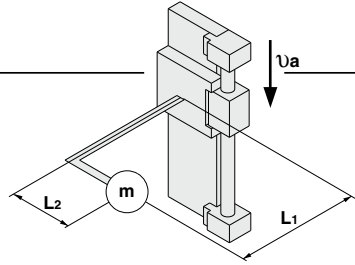

Item	Load factor α_n	Note
1. Load mass 	$\alpha_1 = m/m_{\max}$ $= 3/12$ $= 0.25$	Investigate m . Find the value of m_{\max} at 300 mm/s in Graph (7) for m_4 .
2. Static moment 	$M_1 = m \times g \times L_1$ $= 3 \times 9.8 \times 0.05$ $= 1.47 \text{ [N}\cdot\text{m]}$ $\alpha_{2a} = M_1/M_1 \max$ $= 1.47/14$ $= 0.105$	Investigate M_1 . Find the value of $M_1 \max$ at 300 mm/s in Graph (1).
	$M_3 = m \times g \times L_2$ $= 3 \times 9.8 \times 0.04$ $= 1.176 \text{ [N}\cdot\text{m]}$ $\alpha_{2b} = M_3/M_3 \max$ $= 1.176/14$ $= 0.084$	Investigate M_3 . Find the value of $M_3 \max$ at 300 mm/s in Graph (3).
3. Dynamic moment 	$M_{1E} = 1/3 \times F_E \times L_1$ $(F_E = 1.4/100 \times \upsilon_a \times g \times m)$ $= 0.05 \times \upsilon_a \times m \times L_1$ $= 0.05 \times 300 \times 3 \times 0.05$ $= 2.25 \text{ [N}\cdot\text{m]}$ $\alpha_{3A} = M_{1E}/M_{1E} \max$ $= 2.25/10$ $= 0.225$	Investigate M_{1E} . Find the collision speed υ . $\upsilon = 1.4 \times \upsilon_a$ $= 1.4 \times 300$ $= 420 \text{ [mm/s]}$ Find the value of $M_{1E} \max$ at 420 mm/s in Graph (1).
	$M_{3E} = 0.05 \times \upsilon_a \times m \times L_2$ $(F_E = 1.4/100 \times \upsilon_a \times g \times m)$ $= 0.05 \times 300 \times 3 \times 0.04$ $= 1.8 \text{ [N}\cdot\text{m]}$ $\alpha_{3B} = M_{3E}/M_{3E} \max$ $= 1.8/10$ $= 0.18$	Investigate M_{3E} . From above, find the value of $M_{3E} \max$ at 420 mm/s in Graph (3).

From above,

$$\sum \alpha_n = \alpha_1 + \alpha_{2a} + \alpha_{2b} + \alpha_{3A} + \alpha_{3B} = 0.25 + 0.105 + 0.084 + 0.225 + 0.18 = 0.844$$

From $\sum \alpha_n = 0.844 \leq 1$, it is applicable.

Magnetically Coupled Rodless Cylinder: Low Profile Guide Type

CY1F Series

ø10, ø15, ø25

How to Order

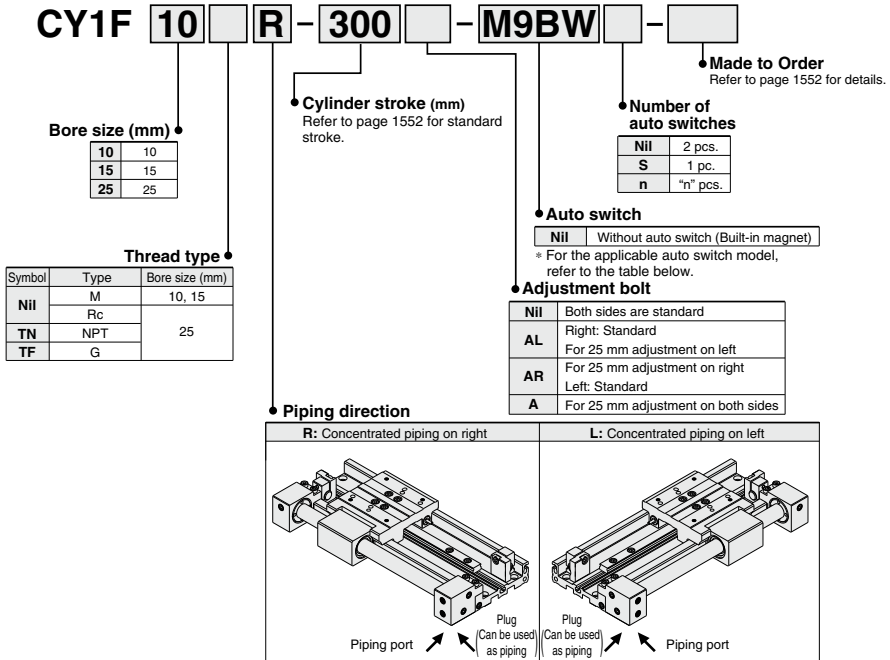

Applicable Auto Switches

Refer to pages 1575 to 1701 for further information on auto switches.

Type	Special function	Electrical entry	Indicator light	Wiring (Output)	Load voltage		Auto switch model		Lead wire length (m)					Pre-wired connector	Applicable load			
					DC	AC	Perpendicular	In-line	0.5 (Nil)	1 (M)	3 (L)	5 (Z)						
Solid state auto switch	Diagnostic indication (2-color indicator)	Grommet	Yes	3-wire (NPN)	24 V	5 V, 12 V	—	M9NV	M9N	●	●	●	○	○	Relay, PLC			
				3-wire (PNP)				M9PV	M9P	●	●	●	○	○				
				2-wire	5 V, 12 V	—	M9NWV	M9NW	●	●	●	○	○					
				3-wire (PNP)			M9PWV	M9PW	●	●	●	○	○					
				2-wire	5 V, 12 V	—	M9BWV	M9BW	●	●	●	○	○					
				3-wire (NPN)			M9NAV ^{*1}	M9NA ^{*1}	○	○	●	○	○					
3-wire (PNP)	M9PAV ^{*1}	M9PA ^{*1}	○	○	●	○	○	○										
Reed auto switch	Water resistant (2-color indicator)	Grommet	Yes	2-wire	24 V	12 V	—	M9BAV ^{*1}	M9BA ^{*1}	○	○	●	○	○	Relay, PLC			
				3-wire (NPN equivalent)				A96V	A96	●	—	—	—	—				
				No	2-wire	24 V	12 V	100 V	100 V or less	—	A93V ^{*2}	A93	●	●		●	—	Relay, PLC
											A90V	A90	●	—		—	—	

*1 Water resistant type auto switches can be mounted on the above models, but in such case SMC cannot guarantee water resistance. Consult with SMC regarding water resistant types with the above model numbers.

*2 1 m type lead wire is only applicable to D-A93.

* Lead wire length symbols: 0.5 m Nil (Example) M9NW
1 m M (Example) M9NWM
3 m L (Example) M9NWL
5 m Z (Example) M9NZZ

* Solid state auto switches marked with a "○" symbol are produced upon receipt of order.

* For details about auto switches with pre-wired connector, refer to pages 1648 and 1649.

* Normally closed (NC = b contact) solid state auto switches (D-M9□E(V)) are also available. Refer to page 1592-1 for details.

* The auto switch is shipped together, but not assembled.

CY3B
CY3R

CY1S

CY1L

CY1H

CY1F

CYP

D-□

-X□

Technical
Data



Made to Order Specifications
[Click here for details](#)

Symbol	Specifications
-XB10	Intermediate stroke (Using exclusive body)
-XB11	Long stroke

Specifications

Bore size (mm)	10	15	25
Fluid	Air		
Lubrication	Non-lube		
Action	Double acting		
Maximum operating pressure (MPa)	0.7		
Min. operating pressure (MPa)	0.2		
Proof pressure (MPa)	1.05		
Ambient and fluid temperature (°C)	-10 to 60 (No freezing)		
Piston speed (mm/s)	50 to 500		
Cushion	Built-in shock absorber		
Stroke length tolerance (mm)	0 to 250st: $^{+1.0}_0$	251 to 1000st: $^{+1.4}_0$	1001st to: $^{+1.8}_0$
Stroke adjustment movable range (mm) ^{Note 1)}	-1.2 to 0.8		-1.4 to 0.6
Piping type	Centralized piping		
Port size ^{Note 2)}	M5 x 0.8		Rc 1/8

Note 1) The stroke adjustment movable range in the above table is that for the standard adjustment bolt. For more information, please refer to page 1559.

Note 2) With ø25, piping screws can be selected by the customer. (Refer to "How to Order".)

Shock Absorber Specifications

Applicable bore size (mm)	10, 15	25	
Shock absorber model	RB0805-X552	RB1006-X552	
Max. energy absorption (J)	0.98	3.92	
Stroke absorption (mm)	5	6	
Max. impact speed (m/s) ^{Note 1)}	0.05 to 5		
Max. operating frequency (cycle/min)	80	70	
Spring force (N)	When extended	1.96	4.22
	When retracted	3.83	6.18
Weight (g)	15	25	

Note 1) Represents the maximum absorption energy per cycle. Thus, the operation frequency can be increased with the absorption energy.

Note 2) The shock absorber service life is different from that of the CY1F cylinder depending on operating conditions. Refer to the Specific Product Precautions for the replacement period.

Standard Stroke

Bore size (mm)	Standard stroke (mm)	Maximum manufacturable stroke (mm)
10	50, 100, 150, 200, 250, 300	500
15	50, 100, 150, 200, 250, 300, 350, 400, 450, 500	750
25	100, 150, 200, 250, 300, 350, 400, 450, 500, 550, 600	1200

* The stroke is available in 1 mm increments with the maximum stroke as the upper limit. For a stroke in the standard stroke range, suffix the part number with -XB10. If the stroke does not fall within the standard stroke range, suffix the part no. with -XB11. Refer to the Made to Order Specifications on pages 1733 and 1739.

Magnetic Holding Force

Unit: N

Bore size (mm)	10	15	25
Magnetic holding force	53.9	137	363

Theoretical Output

Bore size (mm)	Piston area (mm ²)	Operating pressure [MPa]					
		0.2	0.3	0.4	0.5	0.6	0.7
10	78	15	23	31	39	46	54
15	176	35	52	70	88	105	123
25	490	98	147	196	245	294	343

Note) Theoretical output (N) = Pressure (MPa) x Piston area (mm²)

Option

Adjustment Bolt

Bore size (mm)	Standard adjustment bolt	25 mm adjustment bolt
10, 15	CYF-S10	CYF-L10
25	CYF-S25	CYF-L25

Weight

Model	Basic weight	Additional weight per each 50 mm of stroke	Unit: kg	
			Standard adjustment bolt weight	Weight of adjustment bolt for 25 mm adjustment
CY1F10	0.520	0.095	0.004	0.012
CY1F15	0.815	0.133	0.004	0.012
CY1F25	1.970	0.262	0.007	0.021

Calculation method

Example: **CY1F15-150AL**

Basic weight0.815 kg
 Additional weight0.133 kg/50 st
 Standard adjustment bolt weight0.004 kg
 Weight of adjustment bolt for 25 mm adjustment ...0.012 kg
 $0.815 + 0.133 \times 150 \div 50 + 0.004 + 0.012 = 1.23$ (kg)
 Cylinder stroke150st
 Left 25 mm adjustment bolt
 Right Standard adjustment bolt

Replacement Parts

Part No. of Replacement Shock Absorber

Bore size (mm)	Shock absorber model no.
10, 15	RB0805-X552
25	RB1006-X552

Note) Order 2 units for each unit of cylinder.

Replacement Actuator (Cylinder)

CY1F B 10 [] R - Stroke

Cylinder identification symbol

Bore size (mm)

10	10
15	15
25	25

Piping direction

R	Centralized piping on right
L	Centralized piping on left

Thread type

Symbol	Thread type	Bore size (mm)
NII	M	10, 15
	Rc	
TN	NPT	25
TF	G	

Note) "XB10" or "XB11" is not required at the end of the part number for intermediate or long strokes.

CY3B
CY3R

CY1S

CY1L

CY1H

CY1F

CYP

D-□

-X□

Technical Data

CY1F Series

Construction

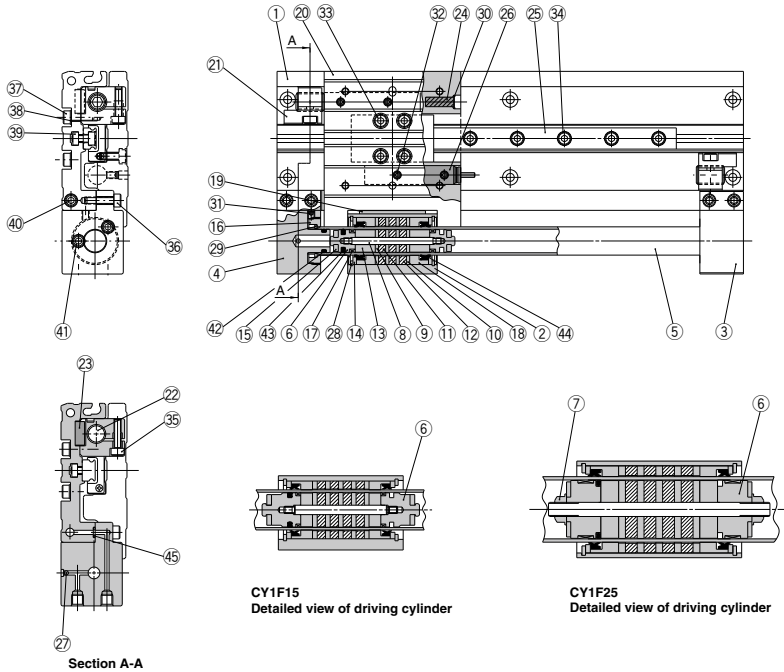

CY1F15
Detailed view of driving cylinder

CY1F25
Detailed view of driving cylinder

Section A-A

Component Parts

No.	Description	Material	Note
1	Body (rodless cylinder)	Aluminum alloy	Anodized
2	Body	Aluminum alloy	Hard anodized
3	End cover A	Aluminum alloy	Hard anodized
4	End cover B	Aluminum alloy	Hard anodized
5	Cylinder tube	Stainless steel	
6	Piston	Aluminum alloy	Chromate
7	Piston nut	Carbon steel	(Only for ø25)
8	Shaft	Stainless steel	
9	Piston side yoke	Rolled steel plate	Zinc chromated
10	External slider side yoke	Rolled steel plate	Zinc chromated
11	Magnet A	—	
12	Magnet B	—	
13	Piston spacer	Aluminum alloy	Chromate
14	Spacer	Rolled steel plate	Nickel plated
15	Bumper	Urethane rubber	
16	Attachment ring	Aluminum alloy	Hard anodized
17	Wear ring A	Special resin	
18	Wear ring B	Special resin	
19	Wear ring C	Special resin	
20	Slide table	Aluminum alloy	Hard anodized
21	Adjuster holder	Carbon steel	Electroless nickel plated
22	Adjustment bolt	Chrome molybdenum steel	Nickel plated
23	Adjuster holder positioning key	Carbon steel	Zinc chromated
24	Magnet	—	

No.	Description	Material	Note
25	Guide	—	
26	Shock absorber	—	
27	Steel ball	Bearing steel	
28	Type C retaining ring for hole	Carbon tool steel	Phosphate coated
29	Type C retaining ring for axis	Hard steel wire	(ø15)
		Stainless steel	(ø10, ø25)
30	Retaining ring	Stainless steel	
31	Hexagon socket head set screw	Chrome molybdenum steel	Nickel plated
32	Hexagon socket head set screw	Chrome molybdenum steel	Nickel plated
33	Hexagon socket head bolt	Chrome molybdenum steel	Nickel plated
34	Hexagon socket head bolt	Chrome molybdenum steel	Nickel plated
35	Hexagon socket head bolt	Chrome molybdenum steel	Nickel plated
36	Hexagon socket head bolt	Chrome molybdenum steel	Nickel plated
37	Hexagon socket head bolt	Chrome molybdenum steel	Nickel plated
38	Flat washer	Rolled steel	Nickel plated
39	Square nut	Carbon steel	Nickel plated
40	Hexagon socket head plug	Chrome molybdenum steel	Nickel plated
41	Hexagon socket head plug	Chrome molybdenum steel	Nickel plated (Hexagon socket head taper plug for ø25)
42	Cylinder tube gasket	NBR	
43	Piston seal	NBR	
44	Scraper	NBR	
45	Body (rodless cylinder) gasket	NBR	

Auto Switch Mounting

Proper Auto Switch Mounting Position (Detection at stroke end)

D-A9□, D-A9□V (mm)

Bore size (mm)	Mounting pattern ^①		Mounting pattern ^②		Mounting pattern ^③		Note 2) Operating range
	A1	B1	A2	B2	A3	B3	
10	38	60	18	80	38	80	9
15	39	66	19	86	39	86	10
25	44.5	95.5	24.5	115.5	44.5	115.5	11

D-M9□, D-M9□V, D-M9□W, D-M9□WV

D-M9□A, D-M9□AV (mm)

Bore size (mm)	Mounting pattern ^①		Mounting pattern ^②		Mounting pattern ^③		Note 2) Operating range
	A1	B1	A2	B2	A3	B3	
10	34	64	22	76	34	76	5.5
15	35	70	23	82	35	82	5
25	40.5	99.5	28.5	111.5	40.5	111.5	5

Note 1) Adjust the auto switch after confirming the operating conditions in the actual setting.

Note 2) Since the operating range is provided as a guideline including hysteresis, it cannot be guaranteed (assuming approximately ±30% dispersion). It may vary substantially depending on an ambient environment.

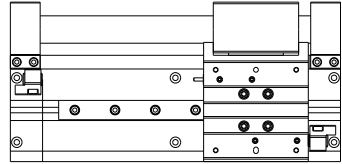

Mounting pattern ①

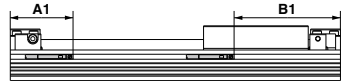

Mounting pattern ②

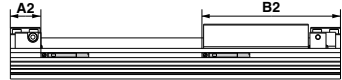

Mounting pattern ③

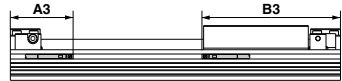

⚠ Caution

① When adjusting the stroke, confirm the minimum stroke for auto switch mounting.

See the table below for the minimum stroke for auto switch mounting.

Minimum Stroke for Auto Switch

Mounting (1 pc.) (mm)

Bore size (mm)	D-A9□ D-A9□V D-M9□ D-M9□V	D-M9□W D-M9□WV D-M9□A D-M9□AV
	10	5
15		
25		

Minimum Stroke for Auto Switch Mounting (2 pcs.) (mm)

Bore size (mm)	D-A90 D-A96	D-A93	D-A90V D-A96V D-A93V	D-M9□ D-M9□W	D-M9□V D-M9□WV D-M9□A D-M9□AV
	Mounting pattern ①, ②	32	35	22	32
Mounting pattern ③	20			12	

Mounting of Auto Switch

As shown below, there are 3 ways to mount the auto switch according to 3 types of electrical entries. Insert the auto switch into the auto switch groove. Then use a flat head watchmaker's screwdriver to tighten the included auto switch mounting screws.

Note) When tightening the mounting screw (included with the auto switch), use a watchmaker's screwdriver with a handle 5 to 6mm in diameter.

Tightening Torque of Auto Switch Mounting Screws (N·m)

Auto switch model	Tightening torque
D-M9□(V) D-M9□W(V) D-A93	0.05 to 0.15
D-M9□A(V) D-A9□(V) (Excludes the D-A93)	0.05 to 0.10 0.10 to 0.20

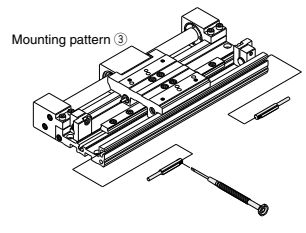
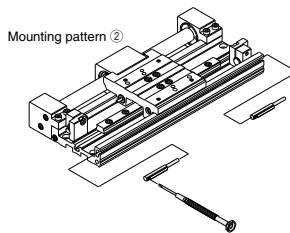
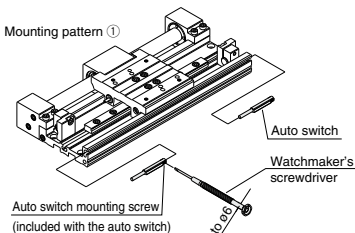



CY1F Series

Specific Product Precautions 1

Be sure to read this before handling the products.

Refer to back page 50 for Safety Instructions and pages 3 to 12 for Actuator and Auto Switch Precautions.

Mounting

⚠ Caution

1. Do not apply a large impact or excessive moment to the slide table (slider).

Because the slide table (slider) is supported by a precision bearing, do not apply a large impact or excessive moment when mounting a workpiece.

2. Align carefully when connecting to a load with an external guide mechanism.

Although a magnetic rodless cylinder (CY1F series) can directly receive a load within the allowable range of the guide, it is necessary to align sufficiently when connecting to a load with an external guide mechanism.

The longer the stroke is, the greater the displacement of the shaft center becomes. Therefore, adopt a connection method (floating mechanism) that can ensure absorption of the displacement.

3. Be sure to use the 4 mounting holes on both ends of the guide body when mounting the product on equipment.

The mounting hole at the center of the guide body is used to mount an intermediate support. Be sure to use the 4 mounting holes at both ends to secure the product.

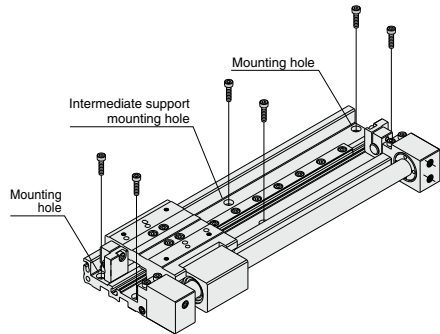

4. When a 25 mm adjustment bolt is selected, the mounting holes will be hidden behind it. Adjust the adjustment bolt after the cylinder is installed.

According to "2. Adjusting bolt adjustment" on page 1559, move the adjustment bolt to a position where it does not interfere with any of the mounting holes and secure the cylinder with mounting screws. After securing the cylinder, readjust the stroke with the adjustment bolt.

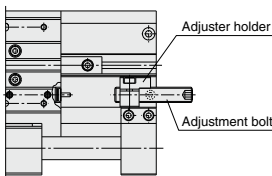

25 mm adjustment bolt

⚠ Caution

5. Long stroke operation causes deflection of the path table or cylinder tube. In such a case, provide an intermediate support.

Provide an intermediate support with the mounting holes on the center of the path table so that the distance between supports given as L in the figure will not exceed the value shown in the graph.

- If the counter surface lacks precision, malfunction may result so adjust the level at the same time.
- In an environment where vibration or impact occurs, provide an intermediate support even if the distance is within the allowable range in the graph.

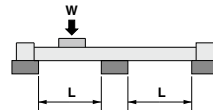
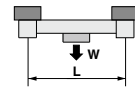
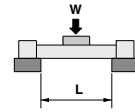

Distance between Load and Supports

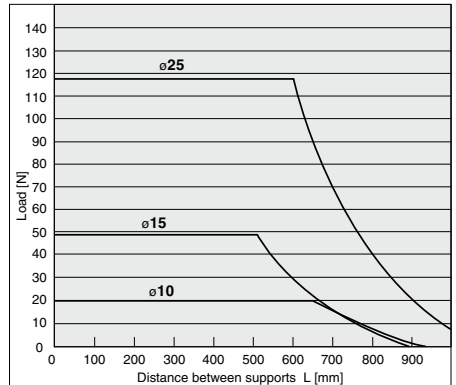

CY3B
CY3R

CY1S

CY1L

CY1H

CY1F

CYP

6. There are limitations on the load mass and operating pressure in case the product is used in the vertical direction.

When using the product in the vertical direction, confirm the allowable values in "Vertical Operation" in Model Selection (1) on page 1548. If the allowable value is exceeded, the magnet coupling may slip off, causing the workpiece to drop down.

D-

-X

Technical Data



CY1F Series

Specific Product Precautions 2

Be sure to read this before handling the products.

Refer to back page 50 for Safety Instructions and pages 3 to 12 for Actuator and Auto Switch Precautions.

Handling

⚠ Caution

1. Do not inadvertently move the guide adjusting unit.

The guide is installed at the proper tightening torque. Do not loosen the mounting bolts of the guide.

2. Do not operate the magnetic rodless cylinder if the magnet couplings on the actuator are displaced.

If the magnet couplings are displaced by an external force beyond the holding force, supply an air pressure of 0.7 MPa to the cylinder port to return the external slider to the right position of the stroke end.

3. Take precautions to avoid getting your hands caught in the unit.

Be careful not to let your hand caught between the slide table and adjuster holder at the stroke end. Install a protective cover or take some other measures to keep any part of the human body from directly touching the place.

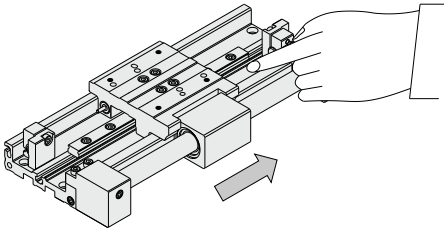

4. Never disassemble the magnetic component parts (external slider, internal slider) of the actuator (cylinder).

If will cause decline of the holding force, etc.

5. Do not use the cylinder in an environment where the cylinder is expose to moisture, adhesive foreign matter, dust or liquid such as water or cutting fluid.

If the cylinder is used in an environment where the lubrication of the cylinders sliding parts is compromised, please consult SMC.

Piping

⚠ Caution

1. Be careful about the direction of the piping port and that of the slide table movement.

The direction of the piping port and that of the slide table movement differ between the right side centralized piping and left side centralized piping.

Centralized piping on right

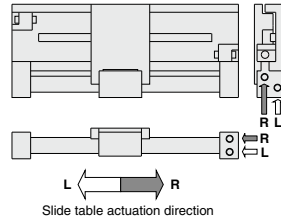

Centralized piping on left

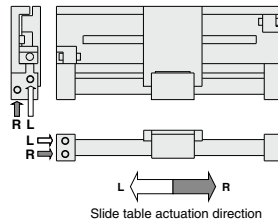

2. The plug position of the piping port can be changed to suit the operating conditions.

When screwing in the plug for the second time, wrap a sealant tape around the plug to prevent leakage.

(1) M5

First tighten lightly until the rotation stops. Then tighten an additional 1/6 to 1/4 turn.

(2) Rc 1/8

Tighten with a 7 to 9 N·m torque using tightening tools.



CY1F Series

Specific Product Precautions 3

Be sure to read this before handling the products.

Refer to back page 50 for Safety Instructions and pages 3 to 12 for Actuator and Auto Switch Precautions.

Adjustment

⚠ Caution

1. Stroke adjustable range

The stroke of CY1F series can be controlled by adjusting the attached adjustment bolt.

For stroke adjustment amount, please refer to the table below.

Bore size (mm)	Standard adjustment bolt	25 mm adjustment bolt
10	-1.2 to 0.8	-25.2 to 0.8
15	-1.2 to 0.8	-25.2 to 0.8
25	-1.4 to 0.6	-25.4 to 0.6

(mm)

The adjustment values above are those for one side.

2. Adjusting bolt adjustment

- 1) Loose the adjustment bolt fixing bolts.
- 2) Insert a hexagon wrench into a hexagon hole at the end of the adjustment bolt to adjust the adjustment bolt.
- 3) After adjustment, tighten the adjustment bolt fixing bolts.

Bore size (mm)	Adjustment bolt fixing bolts	Tightening torque	Adjustment width across flats
10	M3	1.0 to 1.3 N·m	4
15			
25	M5	4.6 to 6.2 N·m	5

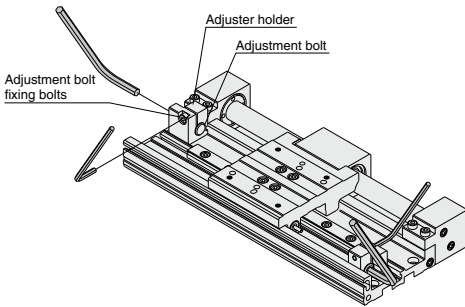

⚠ Caution

1. When adjusting the stroke, be careful about the operating pressure limits.

When making the stroke smaller than the reference stroke with the adjustment bolt, operate at a pressure below the operating pressure limit in (1) "Intermediate stop by external stopper or stroke adjustment with adjustment bolt" on page 1548. If the operating pressure limit is exceeded, the magnet coupling on the actuator (cylinder) will slip off.

2. When adjusting the stroke, use the distance from the end of the adjustment bolt to the end of the adjuster holder as a guideline.

If dimension A is made smaller than 0, the slide table and adjuster holder will collide, resulting in damage to the slide table such as scratches or gouges.

Bore size (mm)	At the minimum stroke of standard adjustment bolt	At the minimum stroke of 25 mm adjustment bolt	Basic stroke	At maximum stroke adjustment
10	A < 2	A < 26	A = 0.8	A ≥ 0
15				
25	A < 2	A < 26	A = 0.6	

(mm)

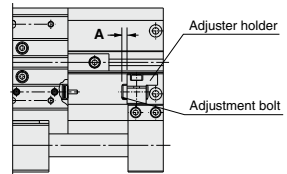

Standard adjustment bolt

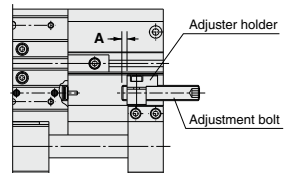

25 mm adjustment bolt

CY3B
CY3R

CY1S

CY1L

CY1H

CY1F

CYP

D-□

-X□

Technical
Data



CY1F Series

Specific Product Precautions 4

Be sure to read this before handling the products.

Refer to back page 50 for Safety Instructions and pages 3 to 12 for Actuator and Auto Switch Precautions.

Maintenance and Replacement

⚠ Caution

Replacement of Actuator

1. The actuator (cylinder) of the CY1F series can be replaced.

Refer to "Replacement Actuator (Cylinder)" on page 1553 about how to order .

2. Replacement of actuator (cylinder) of the CY1F series.

- 1) Remove the 4 cylinder fixing bolts and pull out the actuator from the guide.
- 2) Apply grease to the gaskets attached to the replacement actuator (cylinder) and replace the installed gaskets with the new ones.
- 3) Fit the slider of the replacement actuator into the recessed part of the slide table. Align the surface C (on the side with round mounting holes) of the end cover of the replacement actuator and surface D of the stepped part on the guide.
- 4) In the condition described in (3), put surface A and surface B in close contact with each other. Tighten the 4 cylinder fixing bolts evenly.

Bore size (mm)	Cylinder fixing bolt	Tightening torque
10	M3	0.55 to 0.72 N·m
15		
25	M5	2.6 to 3.5 N·m

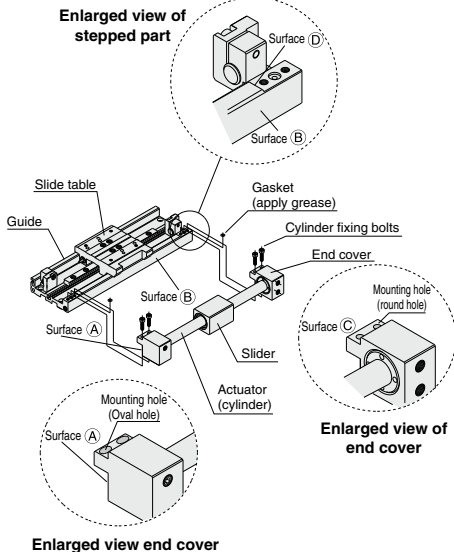

3. Be sure to fasten the cylinder fixing bolts.

Fasten the cylinder fixing bolts firmly. If they become loose, damage or malfunction may result. After replacing the actuator, be sure to conduct a test run before actually using the product.

⚠ Caution

Replacement of Shock Absorber

1. The shock absorber of the CY1F series can be replaced.

The shock absorber should be replaced as a spare part if a decline in the energy absorption capacity is observed.

Refer to the table below about how to order a replacement shock absorber.

Bore size (mm)	No.
10	RB0805-X552
15	
25	RB1006-X552

2. Replacement of shock absorber

Follow the steps below to replace the shock absorber.

- 1) Remove the workpiece from the slide table.
- 2) Loosen the 4 hexagon socket head screws on the top of the slide table and pull out the shock absorber.
- 3) Insert the replacement shock absorber into the slide table until it reaches the rear end and tighten 4 hexagon socket head screws.

Bore size (mm)	Hexagon socket head set screw	Tightening torque
10	M3	0.37 to 0.45 N·m
15		
25	M5	0.54 to 0.64 N·m

3. Be careful about the tightening torque of the hexagon socket head screws.

Be careful excessive tightening may cause damage or malfunction of the shock absorber.

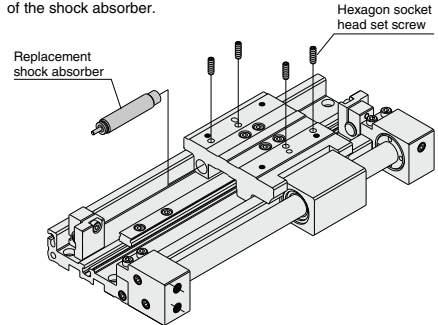

Service Life and Replacement Period of Shock Absorber

⚠ Caution

1. Allowable operating cycle under the specifications set in this catalog is shown below.

- 1.2 million times RB08 □ □
- 2 million times RB10 □ □ to RB2725

Note 1) Specified service life (suitable replacement period) is the value at room temperature (20 to 25°C). The period may vary depending on the temperature and other conditions. In some cases the absorber may need to be replaced before the allowable operating cycle above.