

Cylinder with Lock

CNS Series

ø125, ø140, ø160

A locking cylinder ideal for intermediate stops, emergency stops and drop prevention.

Simple construction

A force magnifying mechanism is employed based on the wedge effect of the taper ring and steel balls.

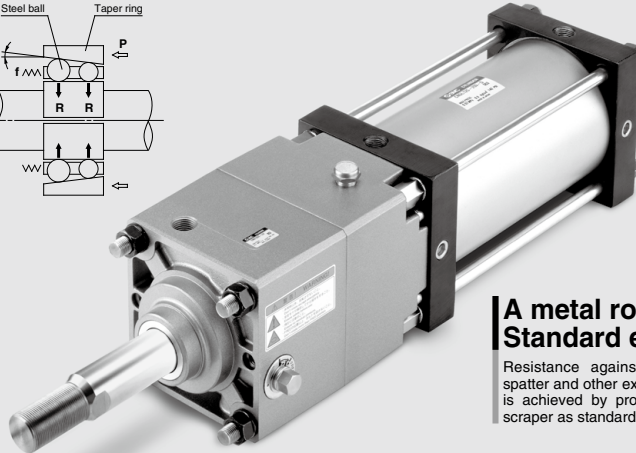
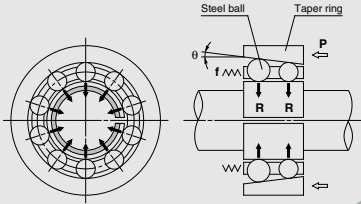

A metal rod scraper Standard equipment

Resistance against welding process spatter and other external contaminants is achieved by providing a metal rod scraper as standard.

High locking efficiency

Greater locking efficiency as well as stable locking and unlocking operation has been achieved by arranging a large number of steel ball bearings in circular rows. (Unlocking pressure of 0.25 MPa 0.05 MPa lower than conventional SMC products) In addition, both alignability and stable locking force with respect to piston rod eccentricity are obtained by allowing the taper ring to float.

High reliability and stable holding force

Outstanding durability and stable holding force are maintained by the use of a brake shoe having superior wear resistance, which has also been substantially lengthened (double the conventional SMC product).

Manual override for unlocking for emergency

Even if the air supply is blocked or exhausted, lock release is possible. The fail safe mechanism locks again when the manual override is released.

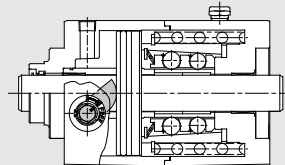

Design minimizes the influences of unlocking air quality

A construction which is strong against moisture and drainage in the compressed air has been realized by separating the locking mechanism and the unlocking chamber.

Series Variations

Series	Action	Type	Standard variations With rod boot	Bore size (mm)	Lock holding force (kN)	Standard stroke (mm)
Cylinder with lock CNS series	Double acting	Single rod CNS series		125	8.4	Maximum 1600
				140	10.5	
				160	13.8	

Can be locked in both directions

All equal holding force can be obtained on either reciprocating stroke of the cylinder.

- CLJ2
- CLM2
- CLG1
- CL1
- MLGC
- CNG
- MNB
- CNA2
- CNS**
- CLS
- CLQ
- RLQ
- MLU
- MLGP
- ML1C

- D-□
- X□

CNS Series

Model Selection

Precautions on Model Selection

⚠ Caution

- In order that the originally selected maximum speed is not exceeded, be certain to use a speed controller to adjust the total movement distance of the load so that movement takes place in no less than the applicable movement time. The movement time is the time that is necessary for the load to travel the total movement distance from the start without any intermediate stops.
- In cases where the cylinder stroke and the movement distance of the load are different (double speed mechanism, etc.), use the movement distance of the load for selection purposes.

Example)

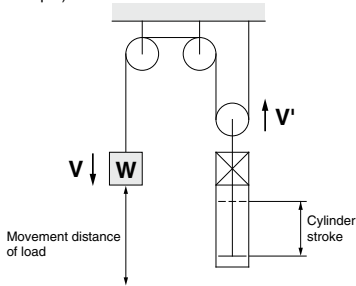

- The following selection example and procedures are based on use at the intermediate stop (including emergency stops during the operation). However, when the cylinder is in the locked state, kinetic energy does not act upon it. Under these conditions, use the load mass at the maximum speed (V) of 100 mm/s shown in graphs 5 to 7 on page 955 depending on the operating pressure and select models.

Selection Example

- Load mass: $m = 320 \text{ kg}$
- Movement distance: $st = 400 \text{ mm}$
- Movement time: $t = 2 \text{ s}$
- Load condition: Vertical downward = Load in direction of rod extension
- Operating pressure: $P = 0.4 \text{ MPa}$

Step (1): From graph (1) find the maximum movement speed of the load

∴ Maximum speed $V = 280 \text{ mm/s}$

Step (2): Select Graph(6) based upon the load condition and operating pressure, and then from the intersection of the maximum speed $V = 280 \text{ mm/s}$ found in Step (1), and the load mass $m = 320 \text{ kg}$

∴ $\phi 140 \rightarrow$ select a CNS140 or larger bore size.

Step 1 Find the maximum load speed V.

Find the maximum load speed: V (mm/s) from the load movement time: t (s) and the movement distance: st (mm).

Graph (1)

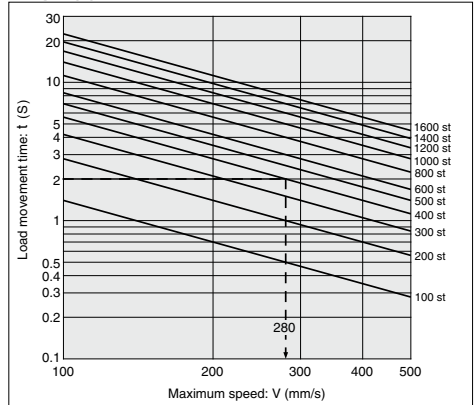

Step 2 Find the bore size.

Select a graph based upon the load condition and operating pressure, and then find the point of intersection for the maximum speed found in Step (1) and the load mass. Select the bore size on the line above the point of intersection.

Load Condition

Operating Pressure

Load in the direction at the right angle to rod

(* Being held by a guide)

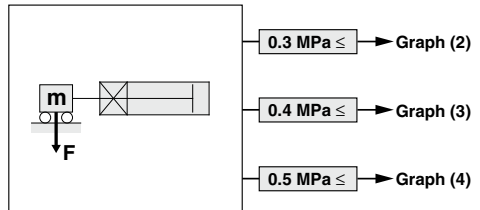

Load in the direction of rod extension
Load in the direction of rod retraction

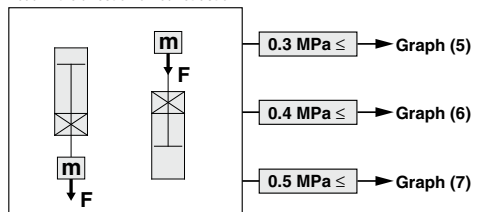

Selection Graph

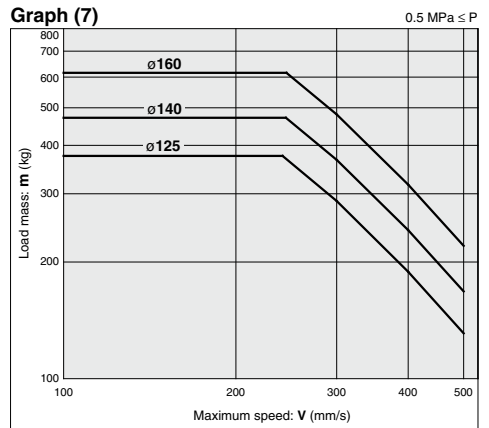
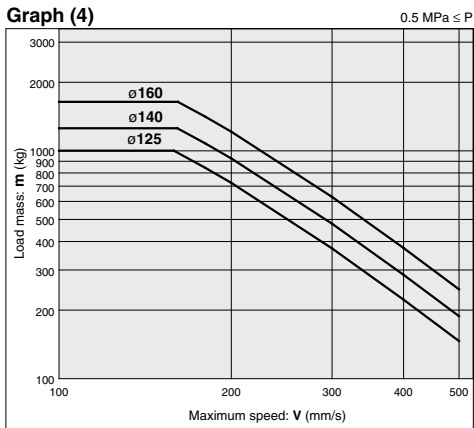
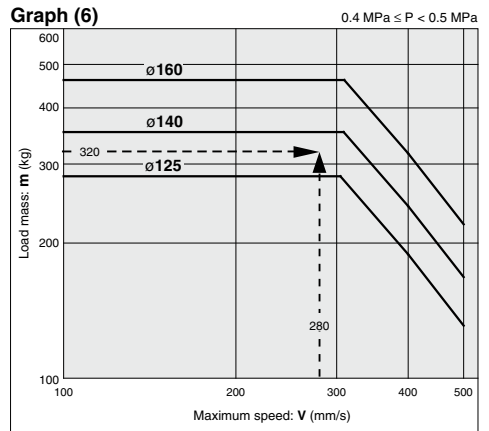
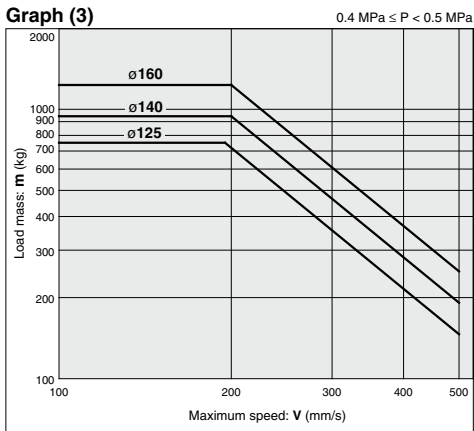
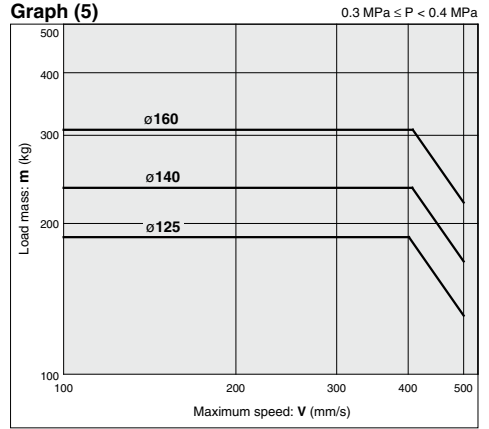
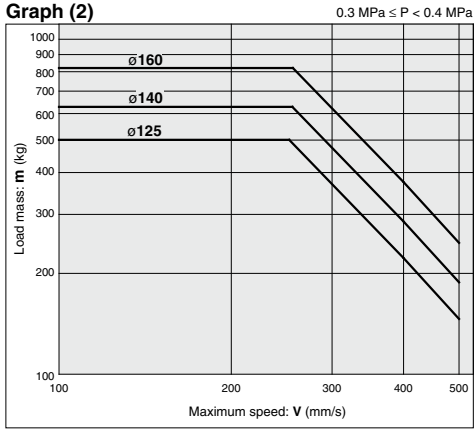

- CLJ2
- CLM2
- CLG1
- CL1
- MLGC
- CNG
- MNB
- CNA2
- CNS
- CLS
- CLQ
- RLQ
- MLU
- MLGP
- ML1C

- D-
- X

Cylinder with Lock Double Acting, Single Rod

CNS Series

∅125, ∅140, ∅160

How to Order

CNS L 125 100 D

With auto switch **CDNS L 125 100 D M9BW**

Mounting type

B	Basic type
L	Foot type
F	Rod side flange type
G	Head side flange type
C	Single clevis type
D	Double clevis type
T	Center trunnion type

Tubing material

Symbol	Bore size	Without magnet		Built-in magnet	
		Tubing material	Tubing material	Tubing material	Tubing material
Nil	∅125, ∅140	Aluminum tube (1000 st or less)	Aluminum tube	Aluminum tube (1000 st or less)	Aluminum tube
		Steel tube (1001 st or more)	Aluminum tube	Steel tube (1201 st or more)	Aluminum tube
F ⁻¹	∅125 to ∅160	Aluminum tube (1200 st or less)	Aluminum tube	Steel tube (1201 st or more)	Aluminum tube
		Steel tube (1201 st or more)	Aluminum tube	Steel tube (1201 st or more)	Aluminum tube

* 1 Auto switches are not available with steel tube.

Bore size

125	125 mm
140	140 mm
160	160 mm

Thread type

Nil	Rc
TN	NPT
TF	G

Number of auto switches

Nil	2 pcs.
S	1 pc.
n	"n" pcs.

Auto switch

Nil	Without auto switch
-----	---------------------

* Select applicable auto switch part numbers from the table below.

Locking direction

D	Both directions
---	-----------------

Made to Order
Refer to page 957 for details.

With rod boot/cushion

Rod boot	Nil	Without rod boot
	J	Nylon tarpaulin
Cushion	K	Heat resistant tarpaulin
	Nil	With double-side cushion
	N	Without cushion
	R	With rod cushion
H	With head cushion	

Cylinder stroke (mm)
Refer to page 957 for maximum stroke.

Applicable Auto Switches

Refer to pages 1119 to 1245 for further information on auto switches.

Type	Special function	Electrical entry	Indicator light	Wiring (Output)	Load voltage			Auto switch model		Lead wire length (m)					Pre-wired connector	Applicable load	
					DC		AC	Tie-rod mounting	Band mounting	0.5 (Nil)	1 (M)	3 (L)	5 (Z)	IC circuit			
					24 V	5 V, 12 V	—	M9N	—	●	●	○	○				○
Solid state auto switch	—	Grommet	—	3-wire (NPN)	24 V	5 V, 12 V	—	M9P	—	●	●	○	○	○	Relay, PLC		
				3-wire (PNP)				—	●	●	○	○	○				
		2-wire	—	●	●	○	○	○	—								
		Terminal conduit	—	●	●	○	○	○	—								
	Diagnostic indication (2-color indicator)	Grommet	Yes	—	3-wire (NPN)	24 V	5 V, 12 V	—	G99	—	●	●	○	○	Relay, PLC		
					3-wire (PNP)				—	●	●	○	○	○			
		2-wire	—	●	●	○	○	○	—								
		Terminal conduit	—	●	●	○	○	○	—								
		Water resistant (2-color indicator)	Grommet	—	—	3-wire (NPN)	24 V	5 V, 12 V	—	M9N	—	●	●	○		○	Relay, PLC
						3-wire (PNP)				—	●	●	○	○		○	
With diagnostic output (2-color indicator)	Grommet	—	—	3-wire (NPN)	24 V	5 V, 12 V	—	M9PW	—	●	●	○	○	Relay, PLC			
				3-wire (PNP)				—	●	●	○	○	○				
Magnetic field resistant (2-color indicator)	Grommet	—	—	2-wire	24 V	12 V	—	M9B	—	●	●	○	○	Relay, PLC			
				3-wire (NPN)				—	●	●	○	○	○				
Reed auto switch	—	—	Yes	3-wire (NPN equivalent)	24 V	5 V	—	A96	—	●	●	○	○	Relay, PLC			
								12 V	100 V	A93	—	●	●		○	○	Relay, PLC
		Terminal conduit	No	—	2-wire	24 V	5 V, 12 V	100 V or less	100 V, 200 V	A90	—	●	●	○	Relay, PLC		
										100 V, 200 V	A54	—	●	●		○	Relay, PLC
	DIN terminal	Yes	—	—	2-wire	24 V	12 V	100 V, 200 V	—	A33	—	—	—	Relay, PLC			
									—	A34	—	—	—		—		
	Diagnostic indication (2-color indicator)	Grommet	—	—	—	24 V	—	—	A44	—	—	—	—	Relay, PLC			
									—	A59W	—	●	●		○	○	

*1 Water resistant type auto switches can be mounted on the above models, but in such case SMC cannot guarantee water resistance.

Consult with SMC regarding water resistant types with the above model numbers.

* Lead wire length symbols: 0.5 m ---- Nil (Example) M9NW 3 m ---- L (Example) M9NWL 1 m ---- M (Example) M9NWM 5 m ---- Z (Example) M9NWZ

* Solid state auto switches marked with "○" are produced upon receipt of order.

* There are other applicable auto switches than listed above. For details, refer to page 971.

* For details about auto switches with pre-wired connector, refer to pages 1192 and 1193.

* D-A9□/M9□/M9□/M9□/PA/P3DWA□ auto switches are shipped together (not assembled). (Only auto switch brackets are assembled at the time of shipment.)

Cylinder Specifications



Bore size (mm)	125	140	160
Lube	Not required (Non-lube)		
Fluid	Air		
Proof pressure	1.57 MPa		
Max. operating pressure	0.97 MPa		
Min. operating pressure	0.08 MPa		
Piston speed	50 to 500 mm/s *		
Ambient and fluid temperature	Without auto switch: 0 to 70°C (No freezing) With auto switch: 0 to 60°C (No freezing)		
Cushion	Air cushion		
Stroke length tolerance	Up to 250: $^{+1.0}_{-0}$, 251 to 1000: $^{+1.4}_{-0}$, 1001 to 1500: $^{+1.8}_{-0}$, 1501 to 1600: $^{+2.2}_{-0}$		
Mounting	Basic type, Axial foot type, Rod side flange type, Head side flange type, Single clevis type, Double clevis type, Center trunnion type		

* Load limits exist depending upon piston speed when locked, mounting direction and operating pressure.

Lock Specifications

Bore size (mm)	125	140	160
Locking action	Spring locking (Exhaust lock)		
Unlocking pressure	0.25 MPa or more		
Lock starting pressure	0.20 MPa or less		
Operating pressure range	0.25 to 0.7 MPa		
Locking direction	Both directions		
Holding force (max. static load) kN *	8.4	10.5	13.8

* The holding force (max. static load) shows the maximum capability and does not show the normal holding capability. So, select an appropriate cylinder while referring to page 954.

Cylinder Stroke

Tube material	(mm)		
	Aluminum alloy	Carbon steel pipe	
Bore size (mm)	Basic type, Head side flange type, Single clevis type, Double clevis type, Center trunnion type	Basic type, Head side flange type, Single clevis type, Double clevis type, Center trunnion type	Foot type, Rod side flange type
125, 140	Up to 1000	Up to 1000	Up to 1600
160	Up to 1200	Up to 1200	Up to 1600

Cylinder Stroke/Auto Switch Mounting on Cylinder Unit (Built-in Magnet)

Refer to the minimum auto switch mounting stroke (page 970) for those with an auto switch.

Bore size (mm)	(mm)	
	Basic type, Head side flange type, Single clevis type, Double clevis type, Center trunnion type	Foot type, Rod side flange type
125, 140	Up to 1000	Up to 1400
160	Up to 1200	Up to 1400

Stopping Accuracy

Lock type	(mm)		
	Piston speed (mm/s)		
	100	300	500
Spring locking	±0.5	±1.0	±2.0

Condition: Lateral, Supply pressure P = 0.5 MPa

Load mass Upper limit of allowed value

Solenoid valve for locking ... Mounted directly to unlocking port

Maximum value of stopping position dispersion from 100 measurements

Made to Order

Made to Order Specifications
[Click here for details](#)

Symbol	Specifications
-XA□	Change of rod end shape
-XC14	Change of trunnion bracket mounting position

Refer to pages 969 to 971 for cylinders with auto switches.

- Minimum auto switch mounting stroke
- Proper auto switch mounting position (detection at stroke end) and mounting height
- Operating range
- Switch mounting bracket: Part no.

CLJ2

CLM2

CLG1

CL1

MLGC

CNG

MNB

CNA2

CNS

CLS

CLQ

RLQ

MLU

MLGP

ML1C

D-□

-X□

Mounting Bracket Part No.

Bore size (mm)	125	140	160
Foot type ⁽¹⁾	CS1-L12	CS1-L14	CS1-L16
Rod side flange type ⁽²⁾	CS1-FL12	CS1-FL14	CS1-FL16
Head side flange type	CS1-F12	CS1-F14	CS1-F16
Single clevis type	CS1-C12	CS1-C14	CS1-C16
Double clevis type ⁽³⁾	CS1-D12	CS1-D14	CS1-D16

Note 1) When ordering foot bracket, order 2 pieces per cylinder.

Note 2) $\phi 125$ to $\phi 160$ rod side flange type use CS1 series long stroke flanges.

Note 3) Clevis pin and cotter pin (2 pcs.) are shipped together with double clevis type.

Rod Boot Material

Symbol	Rod boot material	Max. ambient temperature
J	Nylon tarpaulin	70°C
K	Heat resistant tarpaulin	110°C *

* Maximum ambient temperature for the rod boot itself.

Accessory

Mounting bracket		Basic type	Foot type	Rod side type Flange side type	Head side flange type	Single clevis type	Double clevis type	Center trunion type
Standard equipment	Clevis pin	—	—	—	—	—	●	—
Option	Rod end nut	●	●	●	●	●	●	●
	Single knuckle joint	●	●	●	●	●	●	●
	Double knuckle joint (With pin)	●	●	●	●	●	●	●
	With rod boot	●	●	●	●	●	●	●

* Refer to page 967 for the accessory bracket dimensions. (For rod boots, refer to page 960.)

** Refer to page 968 when the rod end nut, and the single and double knuckle joints are used together.

Weight / () : Denotes the values for steel tube.

Bore size (mm)		125	140	160
Lock unit weight		14.40	20.20	30.60
Basic weight	Basic type	28.79 (30.26)	37.67 (39.48)	55.31 (57.52)
	Foot type	30.42 (31.89)	40.19 (42.00)	58.11 (60.32)
	Flange type	31.47 (32.94)	42.67 (44.48)	61.70 (63.91)
	Single clevis type	31.86 (33.33)	41.96 (43.77)	60.80 (63.01)
	Double clevis type (Including clevis pin and cotter pin)	32.32 (33.79)	42.71 (44.52)	61.65 (63.86)
	Trunion type	32.92 (34.39)	43.40 (45.21)	62.71 (64.92)
Additional weight per each 100 mm of stroke		1.77 (2.66)	1.96 (3.01)	2.39 (3.58)
Accessory bracket	Single knuckle joint	0.91	1.16	1.56
	Double knuckle joint (With pin)	1.37	1.81	2.48
	Rod end nut	0.16	0.16	0.23

Calculation: (Example) CNSL140-100-D Basic weight..... 40.19 (Foot type, $\phi 140$)

Additional weight 1.96/100 stroke

Cylinder stroke 100 stroke

$40.19 + 1.96 \times 100/100 = 42.15$ kg

Construction Principle

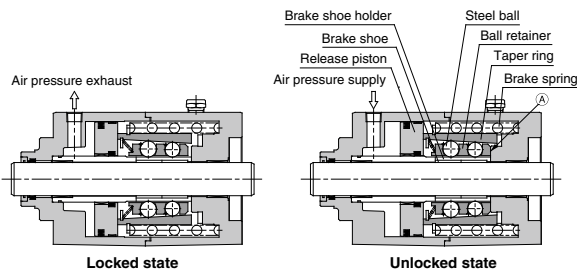

Spring locking (Exhaust lock)

The spring force which acts upon the taper ring is magnified by a wedge effect, and is conveyed to all of the numerous steel balls which are arranged in two circles. These act on the brake shoe holder and brake, which locks the piston rod by tightening against it with a large force.

Unlocking is accomplished when air pressure is supplied to the unlocking port. The release piston and taper ring oppose the spring force, moving to the right side, and the ball retainer strikes the cover section A. The braking force is released as the steel balls are removed from the taper ring by the ball retainer.

Construction

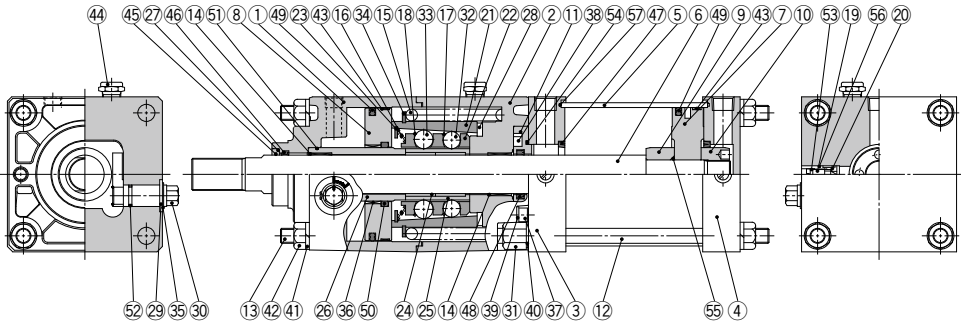

Component Parts

No.	Description	Material	Note
1	Cover A	Aluminum alloy	Hard anodized and painted
2	Cover B	Aluminum alloy	Hard anodized and painted
3	Rod cover	Rolled steel plate	Black painted
4	Head cover	Rolled steel plate	Black painted
5	Cylinder tube	Aluminum alloy	Hard anodized
6	Piston rod	Carbon steel	Hard chrome plated
7	Piston	Aluminum alloy casted	Chromated
8	Release piston	Aluminum alloy	Chromated
9	Cushion ring A	Rolled steel	Zinc chromated
10	Cushion ring B	Rolled steel	Zinc chromated
11	Retaining plate B	Aluminum alloy	
12	Tie-rod A	Carbon steel	Chromated
13	Unit holding tie-rod	Carbon steel	Chromated
14	Bushing	Bearing alloy	
15	Brake spring	Steel wire	Black painted
16	Pre-load spring	Steel wire	Zinc chromated
17	Clip A	Stainless steel wire	
18	Clip B	Stainless steel wire	
19	Cushion valve	Rolled steel	Electroless nickel plated
20	Valve guide	Brass	
21	Taper ring	Carbon steel	Heat treated
22	Ball retainer	Aluminum alloy	
23	Tooth ring	Stainless steel	
24	Brake shoe	Babbitt	
25	Brake shoe holder	Special steel	Heat treated
26	Piston guide	Carbon steel	Zinc chromated
27	Coil scraper mounting plate	Aluminum alloy	Anodized
28	Bumper	Polyurethane rubber	
29	Washer	Carbon steel	Zinc chromated

Component Parts

No.	Description	Material	Note
30	Unlocking cam	Carbon steel	Zinc chromated
31	Wing nut	Carbon steel	
32	Steel ball A	Carbon steel	
33	Steel ball B	Carbon steel	
34	Type C retaining ring for shaft (for taper ring)	Carbon steel	
35	Type C retaining ring for axis (for unlocking cam)	Carbon steel	
36	Bushing (for release piston)	Bearing alloy	
37	Hexagon socket head cap screw	Chromium molybdenum steel	
38	Hexagon socket head cap screw	Chromium molybdenum steel	
39	Conical spring washer	Spring steel	
40	Conical spring washer	Spring steel	
41	Spring washer	Steel wire	
42	Hexagon nut	Rolled steel	
43	Wear ring	Resin	
44	BC element		
45	Coil scraper	Phosphor bronze	
46	Wiper ring	NBR	
47	Cushion seal	NBR	
48	Rod seal	NBR	
49	Piston seal	NBR	
50	O-ring (for release piston)	NBR	
51	O-ring (for piston guide)	NBR	
52	O-ring (for unlocking cam)	NBR	
53	Valve seal	NBR	
54	Retaining plate gasket	NBR	
55	Piston gasket	NBR	
56	Guide gasket	NBR	
57	Tube gasket	NBR	

Replacement Parts/Seal Kit

Bore size (mm)	Kit no.	Contents
125	CS1N125A-PS	Set of above nos. 46, 48, 49, 53, 54, 57
140	CS1N140A-PS	
160	CS1N160A-PS	

* Since the lock section for the CNS series is normally replaced as a unit, kits are for the cylinder section only. These can be ordered using the order number for each bore size.

* Seal kit includes 46, 48, 49, 53, 54, 57. Order the seal kit, based on each bore size.

* Seal kit includes a grease pack (40 g).

Order with the following part number when only the grease pack is needed.

Grease pack part no.: GR-S-010 (10 g), GR-S-020 (20 g)

CLJ2

CLM2

CLG1

CL1

MLGC

CNG

MNB

CNA2

CNS

CLS

CLQ

RLQ

MLU

MLGP

ML1C

D-□

-X□

CNS Series

Dimensions

Basic type (B): CNSB

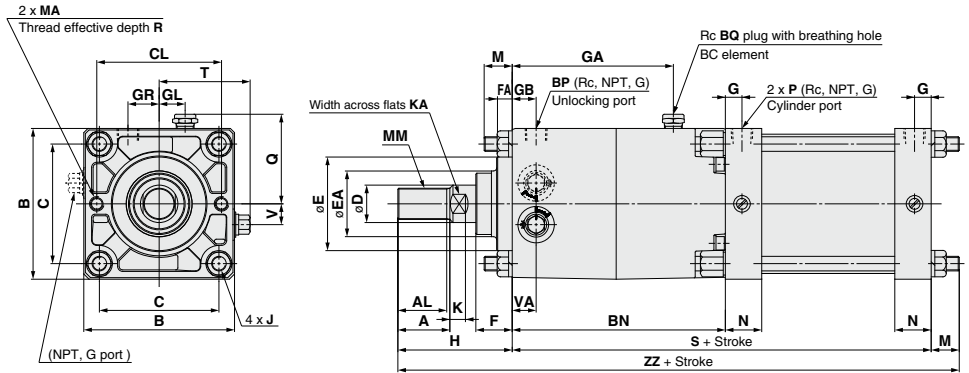

With rod boot

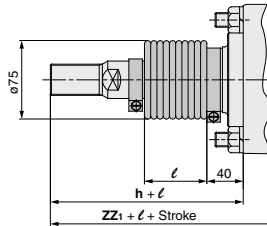

Bore size (mm)	Stroke range (mm)	(mm)																		
		A	AL	B	BN	BP	BQ	C	CL	D	E	EA	F	FA	G	GA	GB	GL	GR	J
125	Up to 1000	50	47	145	205	1/2	3/8	115	120	36	90	63	35	14	16	155	23	25	30	M14 x 1.5
140	Up to 1000	50	47	161	245	1/2	3/8	128	136	36	90	63	35	14	16	180	28	30	30	M14 x 1.5
160	Up to 1200	56	53	182	290	1/2	3/8	144	144	40	90	63	43	14	18.5	215	35	35	35	M16 x 1.5

Bore size (mm)	(mm)																
	K	KA	M	MA	MM	N	P	Q	R	S	T	V	VA	H	ZZ		
125	15	31	27	M12 x 1.75	M30 x 1.5	35	1/2	85.5	25	303	87.5	20	23	110	440		
140	15	31	27	M12 x 1.75	M30 x 1.5	35	1/2	93.5	25	343	95	20	28	110	480		
160	17	36	30.5	M12 x 1.75	M36 x 1.5	39	3/4	104	25	396	109	25	35	120	546.5		

With Rod Boot

Bore size (mm)	Stroke range (mm)	(mm)		
		ZZ1	ℓ	h
125	30 to 1000	463	1/5 stroke	133
140	30 to 1000	503		133
160	30 to 1200	567.5		141

Foot type (L): CNSL

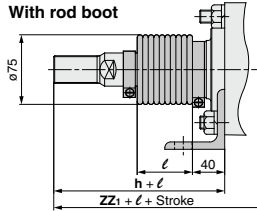
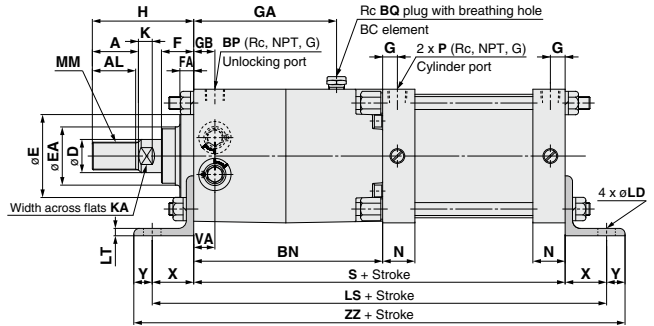
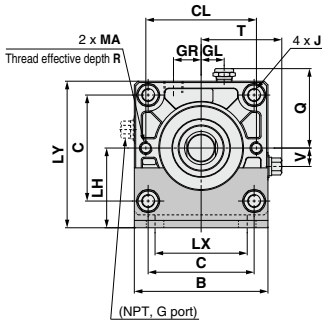

Long stroke

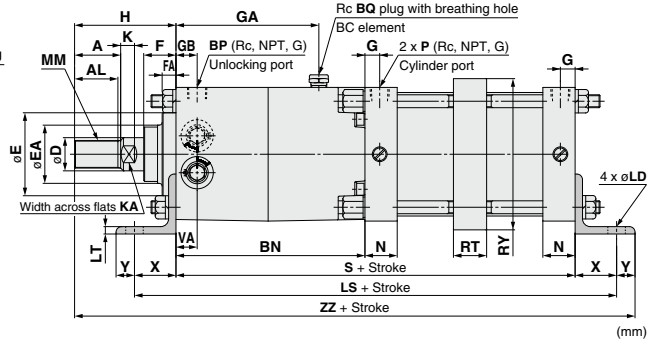
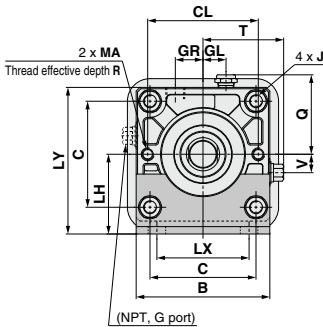

Bore size (mm)	Stroke range (mm)	A	AL	B	BN	BP	BQ	C	CL	D	E	EA	F	FA	G	GA	GB	GL	GR	J
125	Up to 1400	50	47	145	205	1/2	3/8	115	120	36	90	63	35	14	16	155	23	25	30	M14 x 1.5
140	Up to 1400	50	47	161	245	1/2	3/8	128	136	36	90	63	35	14	16	180	28	30	30	M14 x 1.5
160	Up to 1400	56	53	182	290	1/2	3/8	144	144	40	90	63	43	14	18.5	215	35	35	35	M16 x 1.5

Bore size (mm)	K	KA	LD	LH	LS	LT	LX	LY	MA	MM	N	P	Q	R	S	T	V	VA	X	Y	H	ZZ
125	15	31	19	85	393	8	100	157.5	M12 x 1.75	M30 x 1.5	35	1/2	85.5	25	303	87.5	20	23	45	20	110	478
140	15	31	19	100	433	9	112	180.5	M12 x 1.75	M30 x 1.5	35	1/2	93.5	25	343	95	20	28	45	30	110	528
160	17	36	19	106	496	9	118	197	M12 x 1.75	M36 x 1.5	39	3/4	104	25	396	109	25	35	50	25	120	591

With Rod Boot		(mm)		
Bore size (mm)	Stroke range (mm)	ZZ ₁	ℓ	h
125	30 to 1400	501	1/5 stroke	133
140	30 to 1400	551		133
160	30 to 1400	612		141

Long Stroke		(mm)	
Bore size (mm)	Stroke range (mm)	RT	RY
125	1401 to 1600	36	164
140	1401 to 1600	36	184
160	1401 to 1600	45	204

* Not available with auto switches.



- CLJ2
- CLM2
- CLG1
- CL1
- MLGC
- CNG
- MNB
- CNA2
- CNS**
- CLS
- CLQ
- RLQ
- MLU
- MLGP
- ML1C

- D-□
- X□

CNS Series

Dimensions

Rod side flange type (F): CNSF

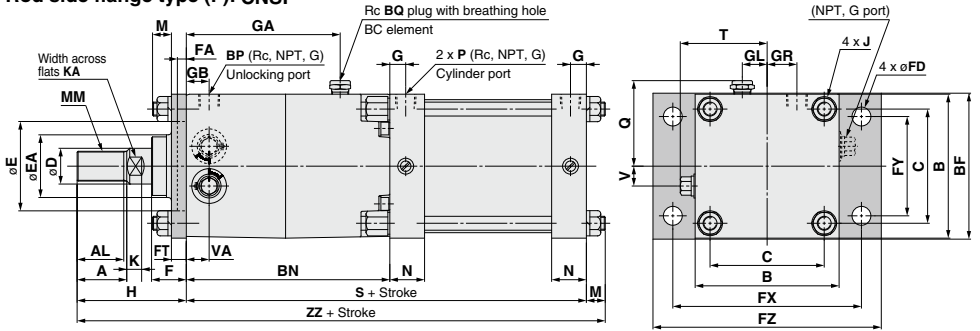

With rod boot

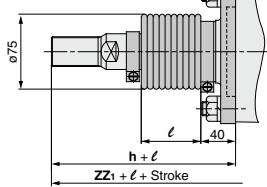

Long stroke

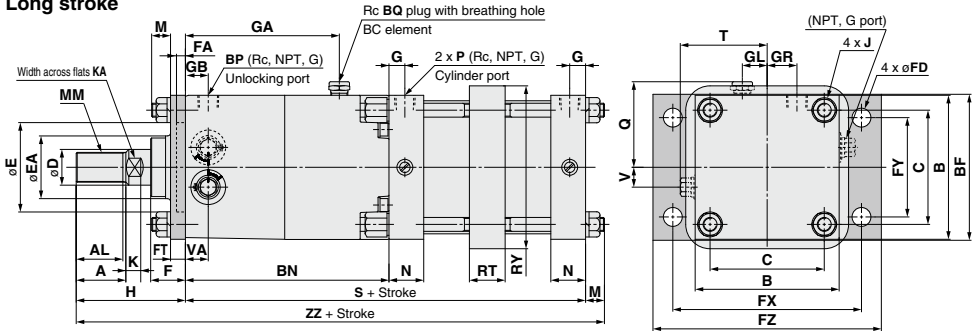

Bore size (mm)	Stroke range (mm)	A	AL	B	BF	BN	BP	BQ	C	D	E	EA	F	FA	FD	FT	FX	FY	FZ	G	GA
125	Up to 1400	50	47	145	145	205	1/2	3/8	115	36	90	63	35	14	19	14	190	100	230	16	155
140	Up to 1400	50	47	161	160	245	1/2	3/8	128	36	90	63	35	14	19	20	212	112	255	16	180
160	Up to 1400	56	53	182	180	290	1/2	3/8	144	40	90	63	43	14	19	20	236	118	275	18.5	215

Bore size (mm)	GB	GL	GR	J	K	KA	M	MM	N	P	Q	S	T	V	VA	H	ZZ
125	23	25	30	M14 x 1.5	15	31	19	M30 x 1.5	35	1/2	85.5	303	87.5	20	23	110	432
140	28	30	30	M14 x 1.5	15	31	19	M30 x 1.5	35	1/2	93.5	343	95	20	28	110	472
160	35	35	35	M16 x 1.5	17	36	22	M36 x 1.5	39	3/4	104	396	109	25	35	120	538

With Rod Boot		(mm)		
Bore size (mm)	Stroke range (mm)	ZZ ₁	ℓ	h
125	30 to 1400	455	1/5 stroke	133
140	30 to 1400	495		133
160	30 to 1400	559		141

Long Stroke		(mm)	
Bore size (mm)	Stroke range (mm)	RT	RY
125	1401 to 1600	36	164
140	1401 to 1600	36	184
160	1401 to 1600	45	204

* Not available with auto switches.

Head side flange type (G): CNSG

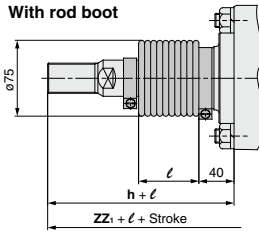
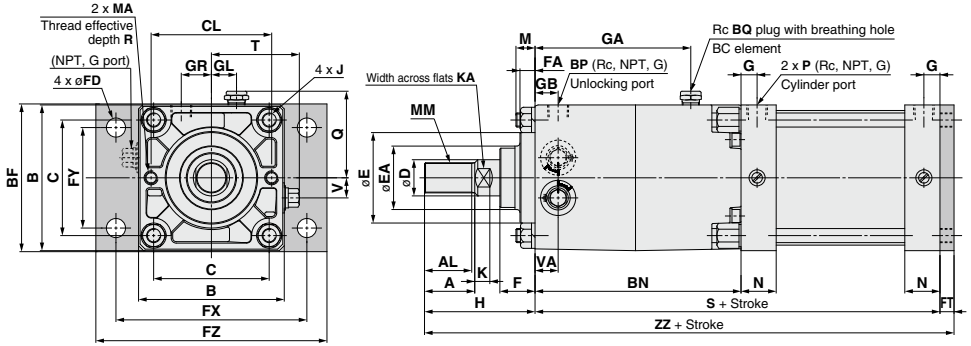

- CLJ2
- CLM2
- CLG1
- CL1
- MLGC
- CNG
- MNB
- CNA2
- CNS**
- CLS
- CLQ
- RLQ
- MLU
- MLGP
- ML1C

																			(mm)									
Bore size (mm)	Stroke range (mm)	A	AL	B	BF	BN	BP	BQ	C	CL	D	E	EA	F	FA	FD	FT	FX	FY	FZ	G	GA						
125	Up to 1000	50	47	145	145	205	1/2	3/8	115	120	36	90	63	35	14	19	14	190	100	230	16	155						
140	Up to 1000	50	47	161	160	245	1/2	3/8	128	136	36	90	63	35	14	19	20	212	112	255	16	180						
160	Up to 1200	56	53	182	180	290	1/2	3/8	144	144	40	90	63	43	14	19	20	236	118	275	18.5	215						

																			(mm)									
Bore size (mm)	GB	GL	GR	J	K	KA	M	MA	MM	N	P	Q	R	S	T	V	VA	H	ZZ									
125	23	25	30	M14 x 1.5	15	31	19	M12 x 1.75	M30 x 1.5	35	1/2	85.5	25	303	87.5	20	23	110	427									
140	28	30	30	M14 x 1.5	15	31	19	M12 x 1.75	M30 x 1.5	35	1/2	93.5	25	343	95	20	28	110	473									
160	35	35	35	M16 x 1.5	17	36	22	M12 x 1.75	M36 x 1.5	39	3/4	104	25	396	109	25	35	120	536									

With Rod Boot					(mm)		
Bore size (mm)	Stroke range (mm)	ZZ ₁	ℓ	h			
125	30 to 1000	450	1/5 stroke	133			
140	30 to 1000	496		133			
160	30 to 1200	557		141			

- D
- X

CNS Series

Dimensions

Single clevis type (C): CNSC

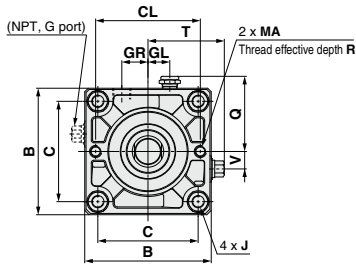
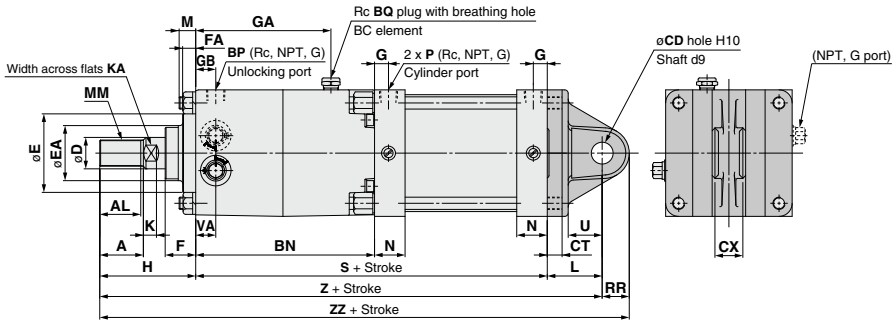

With rod boot

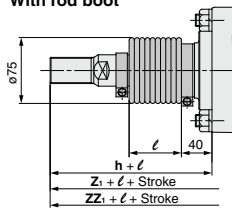

Bore size (mm)	Stroke range (mm)	A	AL	B	BN	BP	BQ	C	CD _{H10}	CL	CT	CX	D	E	EA	F	FA	G	GA	GB	GL
125	Up to 1000	50	47	145	205	1/2	3/8	115	25 ^{+0.084} ₀	120	17	32 ^{-0.1} _{-0.3}	36	90	63	35	14	16	155	23	25
140	Up to 1000	50	47	161	245	1/2	3/8	128	28 ^{+0.084} ₀	136	17	36 ^{-0.1} _{-0.3}	36	90	63	35	14	16	180	28	30
160	Up to 1200	56	53	182	290	1/2	3/8	144	32 ^{+0.100} ₀	144	20	40 ^{-0.1} _{-0.3}	40	90	63	43	14	18.5	215	35	35

Bore size (mm)	GR	J	K	KA	L	M	MA	MM	N	P	Q	R	RR	S	T	U	V	VA	H	Z	ZZ
125	30	M14 x 1.5	15	31	65	19	M12 x 1.75	M30 x 1.5	35	1/2	85.5	25	29	303	87.5	35	20	23	110	478	507
140	30	M14 x 1.5	15	31	75	19	M12 x 1.75	M30 x 1.5	35	1/2	93.5	25	32	343	95	40	20	28	110	528	560
160	35	M16 x 1.5	17	36	80	22	M12 x 1.75	M36 x 1.5	39	3/4	104	25	36	396	109	45	25	35	120	596	632

With Rod Boot

Bore size (mm)	Stroke range (mm)	Z ₁	ZZ ₁	ℓ	h
125	30 to 1000	501	530	1/5 stroke	133
140	30 to 1000	551	583		133
160	30 to 1200	617	653		141

Double clevis type (D): CNSD

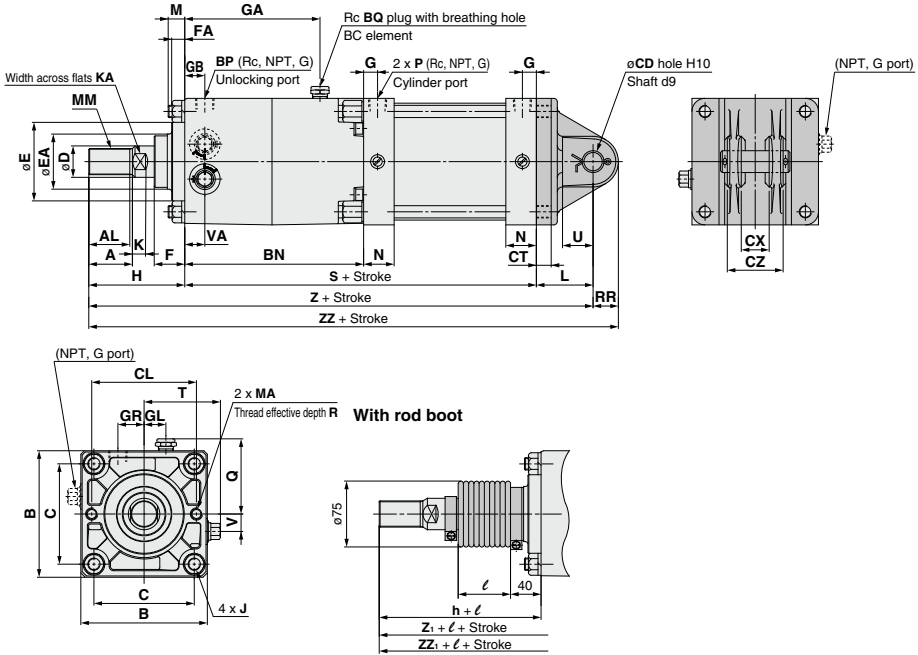

- CLJ2
- CLM2
- CLG1
- CL1
- MLGC
- CNG
- MNB
- CNA2
- CNS**
- CLS
- CLQ
- RLQ
- MLU
- MLGP
- ML1C

(mm)																		
Bore size (mm)	Stroke range (mm)	A	AL	B	BN	BP	BQ	C	CD _{H10}	CL	CT	CX	CZ	D	E	EA	F	FA
125	Up to 1000	50	47	145	205	1/2	3/8	115	25 ^{+0.084} ₀	120	17	32 ^{+0.3} _{+0.1}	64 ⁰ _{-0.2}	36	90	63	35	14
140	Up to 1000	50	47	161	245	1/2	3/8	128	28 ^{+0.084} ₀	136	17	36 ^{+0.3} _{+0.1}	72 ⁰ _{-0.2}	36	90	63	35	14
160	Up to 1200	56	53	182	290	1/2	3/8	144	32 ^{+0.100} ₀	144	20	40 ^{+0.3} _{+0.1}	80 ⁰ _{-0.2}	40	90	63	43	14

(mm)																			
Bore size (mm)	G	GA	GB	GL	GR	J	K	KA	L	M	MA	MM	N	P	Q	R	RR	S	T
125	16	155	23	25	30	M14 x 1.5	15	31	65	19	M12 x 1.75	M30 x 1.5	35	1/2	85.5	25	29	303	87.5
140	16	180	28	30	30	M14 x 1.5	15	31	75	19	M12 x 1.75	M30 x 1.5	35	1/2	93.5	25	32	343	95
160	18.5	215	35	35	35	M16 x 1.5	17	36	80	22	M12 x 1.75	M36 x 1.5	39	3/4	104	25	36	396	109

(mm)						
Bore size (mm)	U	V	VA	H	Z	ZZ
125	35	20	23	110	478	507
140	40	20	28	110	528	560
160	45	25	35	120	596	632

With Rod Boot					(mm)	
Bore size (mm)	Stroke range (mm)	Z ₁	ZZ ₁	ℓ	h	
125	30 to 1000	501	530	1/5 stroke	133	
140	30 to 1000	551	583		133	
160	30 to 1200	617	653		141	

* Clevis pin and cotter pin are shipped together.

- D
- X

CNS Series

Dimensions

Center trunnion type (T): CNST

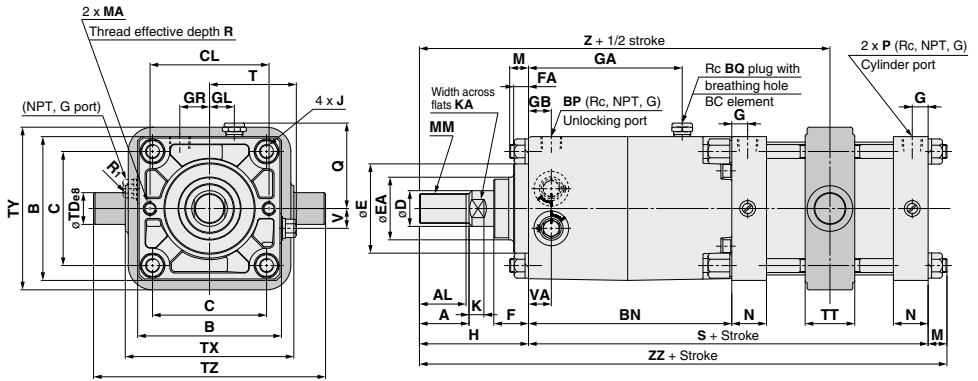

With rod boot

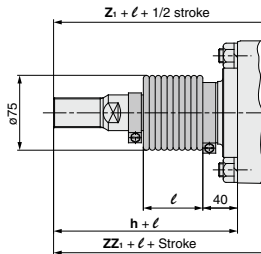

		(mm)																				
Bore size (mm)	Stroke range (mm)	A	AL	B	BN	BP	BQ	C	CL	D	E	EA	F	FA	G	GA	GB	GL	GR	J	K	KA
125	25 to 1000	50	47	145	205	1/2	3/8	115	120	36	90	63	35	14	16	155	23	25	30	M14 x 1.5	15	31
140	30 to 1000	50	47	161	245	1/2	3/8	128	136	36	90	63	35	14	16	180	28	30	30	M14 x 1.5	15	31
160	35 to 1200	56	53	182	290	1/2	3/8	144	144	40	90	63	43	14	18.5	215	35	35	35	M16 x 1.5	17	36

		(mm)																		
Bore size (mm)	M	MA	MM	N	P	Q	R	R ₁	S	T	TD _{es}	TT	TX	TY	TZ	V	VA	H	Z	ZZ
125	19	M12 x 1.75	M30 x 1.5	35	1/2	85.5	25	1	303	87.5	32 ^{+0.050} _{-0.089}	50	170	164	234	20	23	110	364	432
140	19	M12 x 1.75	M30 x 1.5	35	1/2	93.5	25	1.5	343	95	36 ^{+0.050} _{-0.089}	55	190	184	262	20	28	110	404	472
160	22	M12 x 1.75	M36 x 1.5	39	3/4	104	25	1.5	396	109	40 ^{+0.050} _{-0.089}	60	212	204	292	25	35	120	463	538

With Rod Boot (mm)

Bore size (mm)	Stroke range (mm)	Z ₁	ZZ ₁	l	h
125	30 to 1000	387	455	1/5 stroke	133
140	30 to 1000	427	495		133
160	35 to 1200	484	559		141

Accessory Bracket Dimensions 1

Y Type Double Knuckle Joint

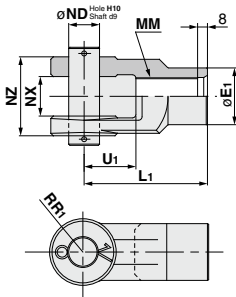

Material: Cast iron

(mm)

Part no.	Applicable bore size (mm)	E1	L1	MM	NDH10	NX	NZ	RR1	U1
Y-12	125	46	100	M30 x 1.5	25 ^{+0.084} ₀	32 ^{+0.3} _{-0.1}	64 ^{-0.1} _{-0.3}	27	42
Y-14	140	48	105	M30 x 1.5	28 ^{+0.084} ₀	36 ^{+0.3} _{-0.1}	72 ^{-0.1} _{-0.3}	30	47
Y-16	160	55	110	M36 x 1.5	32 ^{+0.1} ₀	40 ^{+0.3} _{-0.1}	80 ^{-0.1} _{-0.3}	34	46

* Knuckle pins and cotter pins are included.

CLJ2

CLM2

CLG1

CL1

MLGC

CNG

MNB

CNA2

CNS

CLS

CLQ

RLQ

MLU

MLGP

ML1C

I Type Single Knuckle Joint

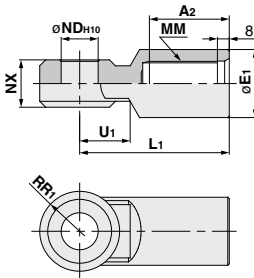

Material: Cast iron

(mm)

Part no.	Applicable bore size (mm)	A2	E1	L1	MM	NDH10	NX	RR1	U1
I-12	125	54	46	100	M30 x 1.5	25 ^{+0.084} ₀	32 ^{-0.1} _{-0.3}	27	33
I-14	140	54	48	105	M30 x 1.5	28 ^{+0.084} ₀	36 ^{-0.1} _{-0.3}	30	39
I-16	160	60	55	110	M36 x 1.5	32 ^{+0.1} ₀	40 ^{-0.1} _{-0.3}	34	39

Clevis Pin/Knuckle Pin

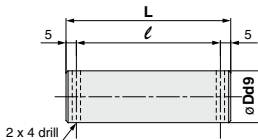

Material: Carbon steel

(mm)

Part no.	Applicable bore size (mm)	Dd9	L	ℓ	Applicable cotter pin
IY-12	125	25 ^{-0.065} _{-0.117}	79.5	69.5	Ø4 x 40 L
IY-14	140	28 ^{-0.065} _{-0.117}	86.5	76.5	Ø4 x 40 L
IY-16	160	32 ^{-0.080} _{-0.142}	94.5	84.5	Ø4 x 40 L

* Cotter pins (2 pcs.) are included.

Rod End Nut

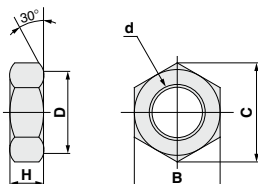

Material: Rolled steel

(mm)

Part no.	Applicable bore size (mm)	d	H	B	C	D
NT-12	125, 140	M30 x 1.5	18	46	53.1	44
NT-16	160	M36 x 1.5	21	55	63.5	53

D-□

-X□

Accessory Bracket Dimensions 2

Single/Double Knuckle Joint Mounting

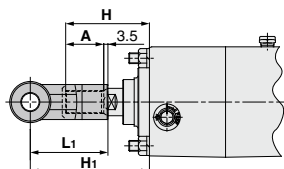

Bore size (mm)	Symbol	H	A	L ₁	H ₁	Applicable knuckle joint part no.	
						I type single knuckle	Y type double knuckle
125		110	50	100	156.5	I-12	Y-12
140		110	50	105	161.5	I-14	Y-14
160		120	56	110	170.5	I-16	Y-16

A, H Dimensions When Mounting a Single/Double Knuckle Joint together with a Rod End Nut

Bore size (mm)	A	H
125	65	125
140	65	125
160	76	140

- * Single knuckle joint and double knuckle joint should be used separately.
(Fasten by screwing completely into the rod end threads.)
- * Extend the dimensions of **A** and **H**, when using a single/double knuckle joint together with a rod end nut.
For extension of **A** and **H** dimensions, refer to the table above and specify "Simple Specials -XA0" (page 1254).

Auto Switch Mounting 2

Minimum Stroke for Auto Switch Mounting

n: Number of auto switch (mm)

Auto switch model	No. of auto switches mounted	Mounting brackets other than center trunnion	Center trunnion		
			ø125	ø140	ø160
D-M9□ D-M9□W	2 (Different surfaces, Same surface) 1	15	105	110	115
	n	$15 + 40 \frac{(n-2)}{2}$ (n = 2, 4, 6, 8 ...) ^{Note 1}	$105 + 40 \frac{(n-4)}{2}$ (n = 4, 8, 12, 16 ...) ^{Note 2}	$110 + 40 \frac{(n-4)}{2}$ (n = 4, 8, 12, 16 ...) ^{Note 2}	$115 + 40 \frac{(n-4)}{2}$ (n = 4, 8, 12, 16 ...) ^{Note 2}
D-M9□V D-M9□WV	2 (Different surfaces, Same surface) 1	10	80	85	90
	n	$10 + 30 \frac{(n-2)}{2}$ (n = 2, 4, 6, 8 ...) ^{Note 1}	$80 + 30 \frac{(n-4)}{2}$ (n = 4, 8, 12, 16 ...) ^{Note 2}	$85 + 30 \frac{(n-4)}{2}$ (n = 4, 8, 12, 16 ...) ^{Note 2}	$90 + 30 \frac{(n-4)}{2}$ (n = 4, 8, 12, 16 ...) ^{Note 2}
D-M9□A	2 (Different surfaces, Same surface) 1	20	115	120	
	n	$20 + 40 \frac{(n-2)}{2}$ (n = 2, 4, 6, 8 ...) ^{Note 1}	$115 + 40 \frac{(n-4)}{2}$ (n = 4, 8, 12, 16 ...) ^{Note 2}	$120 + 40 \frac{(n-4)}{2}$ (n = 4, 8, 12, 16 ...) ^{Note 2}	
D-M9□AV	2 (Different surfaces, Same surface) 1	15	90	95	
	n	$15 + 30 \frac{(n-2)}{2}$ (n = 2, 4, 6, 8 ...) ^{Note 1}	$90 + 30 \frac{(n-4)}{2}$ (n = 4, 8, 12, 16 ...) ^{Note 2}	$95 + 30 \frac{(n-4)}{2}$ (n = 4, 8, 12, 16 ...) ^{Note 2}	
D-A9□	2 (Different surfaces, Same surface) 1	15	100	105	110
	n	$15 + 40 \frac{(n-2)}{2}$ (n = 2, 4, 6, 8 ...) ^{Note 1}	$100 + 40 \frac{(n-4)}{2}$ (n = 4, 8, 12, 16 ...) ^{Note 2}	$105 + 40 \frac{(n-4)}{2}$ (n = 4, 8, 12, 16 ...) ^{Note 2}	$110 + 40 \frac{(n-4)}{2}$ (n = 4, 8, 12, 16 ...) ^{Note 2}
D-A9□V	2 (Different surfaces, Same surface) 1	10	75	80	85
	n	$10 + 30 \frac{(n-2)}{2}$ (n = 2, 4, 6, 8 ...) ^{Note 1}	$75 + 30 \frac{(n-4)}{2}$ (n = 4, 8, 12, 16 ...) ^{Note 2}	$80 + 30 \frac{(n-4)}{2}$ (n = 4, 8, 12, 16 ...) ^{Note 2}	$85 + 30 \frac{(n-4)}{2}$ (n = 4, 8, 12, 16 ...) ^{Note 2}
D-A5/A6 D-A59W D-F5□J59 D-F59W D-F5BA D-F59F	2 (Different surfaces, Same surface) 1	25	125	135	
	n (Same surface)	$25 + 55 \frac{(n-2)}{2}$ (n = 2, 4, 6, 8 ...) ^{Note 1}	$125 + 55 \frac{(n-4)}{2}$ (n = 4, 8, 12, 16 ...) ^{Note 2}	$135 + 55 \frac{(n-4)}{2}$ (n = 4, 8, 12, 16 ...) ^{Note 2}	
D-F5NT	2 (Different surfaces, Same surface) 1	35	145	155	
	n (Same surface)	$35 + 55 \frac{(n-2)}{2}$ (n = 2, 4, 6, 8 ...) ^{Note 1}	$145 + 55 \frac{(n-4)}{2}$ (n = 4, 8, 12, 16 ...) ^{Note 2}	$155 + 55 \frac{(n-4)}{2}$ (n = 4, 8, 12, 16 ...) ^{Note 2}	
D-A3□ D-G39 D-K39	2	Different surfaces 35 Same surface 100	110		
	n	Different surfaces $35 + 30(n-2)$ (n = 2, 3, 4, 5 ...)	$110 + 30(n-2)$ (n = 2, 4, 6, 8 ...) ^{Note 1}		
		Same surface $100 + 100(n-2)$ (n = 2, 3, 4, 5 ...)	$110 + 100(n-2)$ (n = 2, 4, 6, 8 ...) ^{Note 1}		
1	15	110			
D-A44	2	Different surfaces 35 Same surface 55	110		
	n	Different surfaces $35 + 30(n-2)$ (n = 2, 3, 4, 5 ...)	$110 + 30(n-2)$ (n = 2, 4, 6, 8 ...) ^{Note 1}		
		Same surface $55 + 55(n-2)$ (n = 2, 3, 4, 5 ...)	$110 + 50(n-2)$ (n = 2, 4, 6, 8 ...) ^{Note 1}		
1	15	110			
D-Z7□ D-Z80 D-Y59□ D-Y7P D-Y7□W	2 (Different surfaces, Same surface) 1	15	105	110	115
	n	$15 + 40 \frac{(n-2)}{2}$ (n = 2, 4, 6, 8 ...) ^{Note 1}	$105 + 40 \frac{(n-4)}{2}$ (n = 4, 8, 12, 16 ...) ^{Note 2}	$110 + 40 \frac{(n-4)}{2}$ (n = 4, 8, 12, 16 ...) ^{Note 2}	$115 + 40 \frac{(n-4)}{2}$ (n = 4, 8, 12, 16 ...) ^{Note 2}
D-Y69□ D-Y7PV D-Y7□WV	2 (Different surfaces, Same surface) 1	10	90	95	100
	n	$10 + 30 \frac{(n-2)}{2}$ (n = 2, 4, 6, 8 ...) ^{Note 1}	$90 + 30 \frac{(n-4)}{2}$ (n = 4, 8, 12, 16 ...) ^{Note 2}	$95 + 30 \frac{(n-4)}{2}$ (n = 4, 8, 12, 16 ...) ^{Note 2}	$100 + 30 \frac{(n-4)}{2}$ (n = 4, 8, 12, 16 ...) ^{Note 2}
D-Y7BA	2 (Different surfaces, Same surface) 1	20	115	120	125
	n	$20 + 45 \frac{(n-2)}{2}$ (n = 2, 4, 6, 8 ...) ^{Note 1}	$115 + 45 \frac{(n-4)}{2}$ (n = 4, 8, 12, 16 ...) ^{Note 2}	$120 + 45 \frac{(n-4)}{2}$ (n = 4, 8, 12, 16 ...) ^{Note 2}	$125 + 45 \frac{(n-4)}{2}$ (n = 4, 8, 12, 16 ...) ^{Note 2}
D-P3DWA	2 (Different surfaces, Same surface) 1	20	110	115	120
	n	$20 + 50 \frac{(n-2)}{2}$ (n = 2, 4, 6, 8 ...) ^{Note 1}	$110 + 50 \frac{(n-4)}{2}$ (n = 4, 8, 12, 16 ...) ^{Note 2}	$115 + 50 \frac{(n-4)}{2}$ (n = 4, 8, 12, 16 ...) ^{Note 2}	$120 + 50 \frac{(n-4)}{2}$ (n = 4, 8, 12, 16 ...) ^{Note 2}

Note 1) When "n" is an odd number, an even number that is one larger than this odd number is used for the calculation.

Note 2) When "n" is an odd number, a multiple of 4 that is larger than this odd number is used for the calculation.

Operating Range

Auto switch model	Bore size (mm)		
	125	140	160
D-M9□/M9□V D-M9□W/M9□WV D-M9□A/M9□AV	7	6.5	6.5
D-A9□/A9□V	12	12.5	11.5
D-Z7□/Z80	14	14.5	13
D-A3□/A44 D-A5□/A6□	10	10	10
D-A59W	17	17	17
D-Y59□/Y69□ D-Y7P/Y7PV D-Y7□W/Y7□WV D-Y7BA	12	13	7
D-F59F/F5□/J59 D-F5□W/J59W D-F5BA/F5NT	5	5	5.5
D-G39/K39	11	11	10
D-P3DWA	6	6.5	6.5

* Since the operating range is provided as a guideline including hysteresis, it cannot be guaranteed (assuming approximately ±30% dispersion). It may vary substantially depending on an ambient environment.

Auto Switch Mounting Bracket: Part No.

Auto switch model	Bore size (mm)		
	ø125	ø140	ø160
D-M9□/M9□V D-M9□W/M9□WV D-M9□A/M9□AV D-A9□/A9□V	BS5-125	BS5-125	BS5-160
D-A5/A6/A59W D-F5□/J59/F5NT D-F5□W/J59W D-F5BA/F59W	BT-12	BT-12	BT-16
D-A3□/A44 D-G39/K39	BS1-125	BS1-140	BS1-160
D-Z7□/Z80 D-Y59□/Y69□ D-Y7P/Y7PV D-Y7□W/Y7□WV D-Y7BA	BS4-125	BS4-125	BS4-160
D-P3DWA	BS7-125S	BS7-125S	BS7-160S

[Mounting screw set made of stainless steel]

The following set of mounting screws made of stainless steel (including nuts) is available. Use it in accordance with the operating environment. (Please order the auto switch mounting bracket separately, since it is not included.)

BBA1: For D-A5/A6/F5/J5 types

D-F5BA auto switch is set on the cylinder with the stainless steel screws above when shipped. When an auto switch is shipped independently, BBA1 is attached.

Note 1) Refer to page 1233 for the details of BBA1.

Note 2) When using D-M9□A(V)/Y7BA, do not use the steel set screws which is included with the auto switch mounting brackets above (BS5-□□□, BS4-□□□). Order a stainless steel screw set (BBA1) separately, and select and use the M4 x 8L stainless steel set screws included in the BBA1.

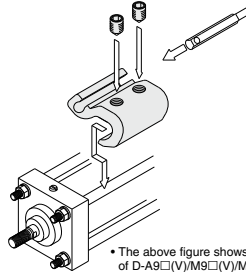

* The above figure shows the mounting example of D-A9□(V)/M9□(V)/M9□W(V)/M9□A(V).

- CLJ2
- CLM2
- CLG1
- CL1
- MLGC
- CNG
- MNB
- CNA2
- CNS
- CLS
- CLQ
- RLQ
- MLU
- MLGP
- ML1C

Other than the applicable auto switches listed in "How to Order", the following auto switches can be mounted. For detailed specifications, refer to pages 1119 to 1245.

Auto switch type	Model	Electrical entry (Fetching direction)	Features
Reed	D-A90V	Grommet (Perpendicular)	Without indicator light
	D-A93V, A96V		—
	D-Z73, Z76		—
	D-A53, A56	Grommet (In-line)	Without indicator light
	D-A64, A67		—
	D-Z80		—
Solid state	D-M9NV, M9PV, M9BV	Grommet (Perpendicular)	—
	D-Y69A, Y69B, Y7PV		—
	D-M9NWV, M9PWV, M9BWW		2-color indicator
	D-Y7NWV, Y7PWV, Y7BWW		Water resistant (2-color indicator)
	D-M9NAV, M9PAV, M9BAV		—
	D-F59, F5P, J59		—
	D-Y59A, Y59B, Y7P	Grommet (In-line)	2-color indicator
	D-F59W, F5PW, J59W		Water resistant (2-color indicator)
	D-Y7NW, Y7PW, Y7BW		With timer
	D-F5BA, Y7BA		—
	D-F5NT		—
			—

* With pre-wired connector is available for solid state auto switches. For details, refer to pages 1192 and 1193.

* Normally closed (NC = b contact) solid state auto switches (D-M9□E(V)/Y7G/Y7H) are also available. For details, refer to pages 1592-1 and 1139.

- D-□
- X□



CNS Series

Specific Product Precautions 1

Be sure to read this before handling the products.

Refer to back page 50 for Safety Instructions and pages 3 to 12 for Actuator and Auto Switch Precautions.

Design of Equipment and Machinery

⚠ Warning

1. Construct so that the human body will not come into direct contact with driven objects or the moving parts of the cylinders with lock.

Devise a safe structure by attaching protective covers that prevent direct contact with the human body, or in cases where there is a danger of contact, provide sensors or other devices to perform an emergency stop, etc., before contact occurs.

2. Use a balance circuit, taking cylinder lurching into consideration.

In cases such as an intermediate stop, where a lock is operated at a desired position within the stroke and air pressure is applied from only one side of the cylinder, the piston will lurch at high speed when the lock is released. In such situations, there is a danger of causing human injury by having hands or feet, etc. caught, and also a danger for causing damage to the equipment. In order to prevent this lurching, a balance circuit such as the recommended pneumatic circuits (pages 973 and 974) should be used.

Selection

⚠ Warning

1. When in the locked state, do not apply a load accompanied by an impact shock, strong vibration or turning force, etc.

Use caution, because an external action such as an impacting load, strong vibration or turning force, may damage the locking mechanism or reduce its life.

2. Consider stopping accuracy and the amount of over-run when an intermediate stop is performed.

Due to the nature of a mechanical lock, there is a momentary lag with respect to the stop signal, and a time delay occurs before stopping. The cylinder stroke resulting from this delay is the overrun amount. The difference between the maximum and minimum overrun amounts is the stopping accuracy.

- Place a limit switch before the desired stopping position, at a distance equal to the overrun amount.
- The limit switch must have a detection length (dog length) of the overrun amount + α .
- SMC auto switches have operating ranges from 8 to 14 mm (depending on the switch model).

When the overrun amount exceeds this range, self-holding of the contact should be performed at the switch load side.

*For stopping accuracy, refer to page 957.

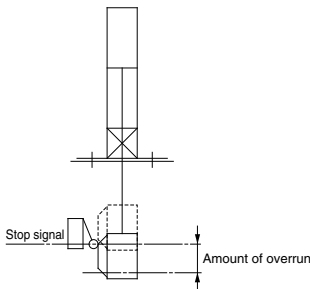

Selection

⚠ Warning

3. In order to further improve stopping accuracy, the time from the stop signal to the operation of the lock should be shortened as much as possible.

To accomplish this, use a device such as a highly responsive electric control circuit or solenoid valve driven by direct current, and place the solenoid valve as close as possible to the cylinder.

4. Note that the stopping accuracy will be influenced by changes in piston speed.

When piston speed changes during the course of the cylinder stroke due to variations in the load or disturbances, etc., the dispersion of stopping positions will increase. Therefore, consideration should be given to establishing a standard speed for the piston just before it reaches the stopping position.

Moreover, the dispersion of stopping positions will increase during the cushioned portion of the stroke and during the accelerating portion of the stroke after the start of operation, due to the large changes in piston speed.

5. The holding force (max. static load) indicates the maximum capability to hold a static load without loads, vibration and impact. This does not indicate a load that can be held in ordinary conditions.

Select the most suitable bore sizes for the operating conditions in accordance with the selection procedures. The Model Selection (pages 954 and 955) is based on use at the intermediate stop (including emergency stops during the operation). However, when the cylinder is in a locked state, kinetic energy does not act upon it. Under these conditions, use the load mass at the maximum speed (V) of 100 mm/s shown in the graphs 5 to 7 on page 955 depending on the operating pressure and select models.

Mounting

⚠ Warning

1. Be certain to connect the rod end to the load with the lock released.

If connected in the locked state, a load greater than the turning force or holding force, etc. may operate on the piston rod and cause damage to the lock mechanism. The CNS series is equipped with an emergency unlocking mechanism; however, when connecting the rod end to the load, this should be done with the lock released. This can be accomplished by simply connecting an air line to the unlocking port and supplying air pressure of 0.25 MPa or more.

2. Do not apply offset loads to the piston rod.

Particular care should be taken to match the load's center of gravity with the center of the cylinder shaft. When there is a large discrepancy, the piston rod may be subjected to uneven wear or damage due to the inertial moment during locking stops.

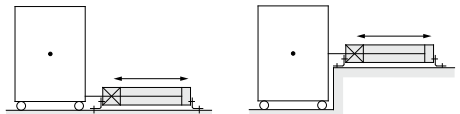

× Load center of gravity and cylinder shaft center are not matched.

○ Load center of gravity and cylinder shaft center are matched.

Note) Can be used if all of the generated moment is absorbed by an effective guide.



CNS Series

Specific Product Precautions 2

Be sure to read this before handling the products.

Refer to back page 50 for Safety Instructions and pages 3 to 12 for Actuator and Auto Switch Precautions.

Mounting

⚠ Caution

1. Caution on using the basic type or replacing the support bracket.

The lock unit and cylinder rod cover are assembled as shown in the figure below. For this reason, it cannot be installed as in the case of common air cylinders, by using the basic type and screwing the cylinder tie-rods directly to machinery.

Furthermore, when replacing mounting brackets, the unit holding tie-rods may get loosen. Tighten them once again in such a case.

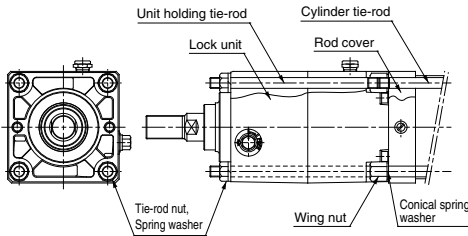

Bore size (mm)	Tie-rod nut	Width across flats	Socket
125	JIS B 1181 Class 2 M14 x 1.5	22	JIS B 4636 socket 22
140	JIS B 1181 Class 2 M14 x 1.5	22	JIS B 4636 socket 22
160	JIS B 1181 Class 2 M16 x 1.5	24	JIS B 4636 socket 24

Adjustment

⚠ Caution

1. Adjust the cylinder's air balance.

Balance the load by adjusting the air pressure in the rod and head sides of the cylinder with the load connected to the cylinder and the lock released. Lurching of the cylinder when unlocked can be prevented by carefully adjusting this air balance.

2. Adjust the mounting positions of the detectors on auto switches, etc.

When intermediate stops are to be performed, adjust the mounting positions of detectors on auto switches, etc., taking into consideration the overrun amount with respect to the desired stopping positions.

3. Do not open the cushion valve excessively.

If the cushion valve is rotated excessively in the opening direction (counterclockwise), it could be damaged. Be aware that the valve could slip out, or the threads becomes too short.

Pneumatic Circuit

⚠ Warning

1. Be certain to use an pneumatic circuit which will apply balancing pressure to both sides of the piston when in a locked stop.

In order to prevent cylinder lurching after a lock stop, when restarting or when manually unlocking, a circuit should be used to which will apply balancing pressure to both sides of the piston, thereby canceling the force generated by the load in the direction of piston movement.

Pneumatic Circuit

⚠ Warning

2. The effective area of the lock release solenoid valve should be at least 50% of the effective area of the cylinder driving solenoid valve, and it should be installed as close to the cylinder as possible so that it is closer than the cylinder driving solenoid valve.

If the effective area of the lock release solenoid valve is small or if it is installed at a distance from the cylinder, the time required for exhausting air for releasing the lock will be longer, which may cause a delay in the locking operation.

The delay in the locking operation may result in problems such as increase of overrun when performing intermediate stop or emergency stop during operation, or if maintaining position from the operation stop state such as drop prevention, workpieces may be dropped depending on the timing of the load action to the operation delay of the lock.

3. Avoid backflow of the exhaust pressure when there is a possibility of interference of exhaust air, for example for a common exhaust type valve manifold.

The lock may not operate properly when the exhaust air pressure backflows due to interference of the exhaust air when exhausting air for lock release. It is recommended to use an individual exhaust type manifold or individual valves.

4. Allow at least 0.5 seconds from a locked stop (intermediate stop of the cylinder) until release of the lock.

When the locked stop time is too short, the piston rod (and load) may lurch at a speed greater than the control speed of the speed controller.

5. When restarting, control the switching signal for the unlocking solenoid valve so that it acts before or at the same time as the cylinder drive solenoid valve.

If the signal is delayed, the piston rod (and load) may lurch at a speed greater than the control speed of the speed controller.

6. Carefully check for dew condensation due to repeated air supply and exhaust of the locking solenoid valve.

The operating stroke of the lock part is very small. So, if the piping is long and the air supply and exhaust are repeated, the dew condensation caused by the adiabatic expansion accumulates in the lock part. This may corrode internal parts, causing air leak or lock release fault.

7. Basic circuit

1. [Horizontal]

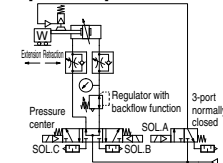

SOL.A	SOL.B	SOL.C	Action	Time
ON	ON	OFF	Extension	
OFF	OFF	OFF	Locked stop	0.5 s or more
ON	OFF	OFF	Unlocked	0 to 0.5 s
ON	ON	OFF	Extension	
ON	OFF	ON	Retraction	
OFF	OFF	OFF	locked stop	0.5 s or more
ON	OFF	OFF	Unlocked	0 to 0.5 s
ON	OFF	ON	Retraction	

2. [Vertical]

[Load in the direction of rod extension]

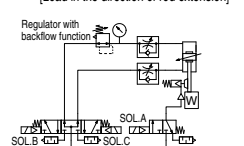

[Load in the direction of rod retraction]

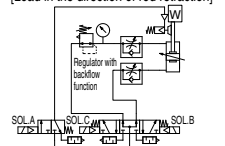

* The symbol for the cylinder with lock in the basic circuit uses SMC original symbol.

CLJ2

CLM2

CLG1

CL1

MLGC

CNG

MNB

CNA2

CNS

CLS

CLQ

RLQ

MLU

MLGP

ML1C

D-□

-X□



CNS Series

Specific Product Precautions 3

Be sure to read this before handling the products.

Refer to back page 50 for Safety Instructions and pages 3 to 12 for Actuator and Auto Switch Precautions.

Pneumatic Circuit

⚠ Caution

- 3-position pressure center solenoid valve and regulator with backflow function can be replaced with two 3-port normally open valves and a regulator with relief function.

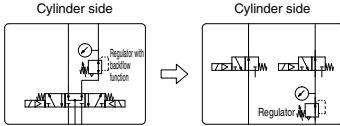

[Example]

- [Horizontal]

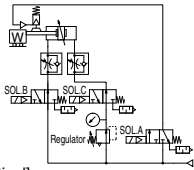

- [Vertical]

[Load in the direction of rod extension] [Load in the direction of rod retraction]

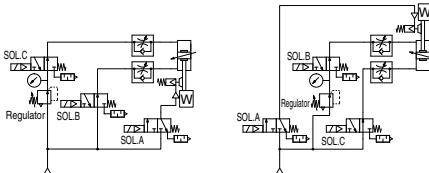

* The symbol for the cylinder with lock in the pneumatic circuit uses SMC original symbol.

Manually Unlocking

⚠ Warning

- Never operate the unlocking cam until safety has been confirmed. (Do not turn to the FREE side.)
 - When unlocking is performed with air pressure applied to only one side of the cylinder, the moving parts of the cylinder will lurch at high speed causing a serious hazard.
 - When unlocking is performed, be sure to confirm that personnel are not within the load movement range and that no other problems will occur if the load moves.
- Before operating the unlocking cam, exhaust any residual pressure which is in the system.
- Take measures to prevent the load from dropping when unlocking is performed.
 - Perform work with the load in its lowest position.
 - Take measures for drop prevention by strut, etc.
 - Confirm that balanced pressure is applied to both sides of the piston.

⚠ Caution

- The unlocking cam is an emergency unlocking mechanism only.

During an emergency when the air supply is stopped or cut off, this is used to alleviate a problem by forcibly pushing back the release piston and brake spring to release the lock.
- When installing the cylinder into equipment or performing adjustments, etc., be sure to apply air pressure of 0.25 MPa or more to the unlocking port, and do not perform work using the unlocking cam.
- When releasing the lock with the unlocking cam, it must be noted that the sliding resistance of the cylinder will be high, unlike normal unlocking with air pressure.

Bore size (mm)	Cylinder sliding resistance (N)	Cam unlocking torque (standard) (N·m)	Width across flats (mm)	Socket
125	961	68.6	16	JIS B 4636 socket 16
140	1216	78.4	18	JIS B 4636 socket 18
160	1579	156.8	21	JIS B 4636 socket 21

- Do not turn the unlocking cam (the arrow or mark on the unlocking cam head) past the position marked FREE. If it is turned too far, there is a danger of damaging the unlocking cam.
- For safety reasons, the unlocking cam is constructed so that it cannot be fixed in the unlocked condition.

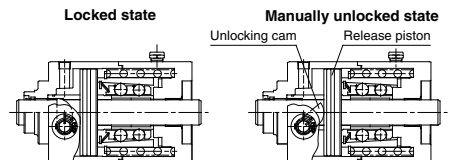

[Principle]

If the unlocking cam is turned clockwise with an adjustable angle wrench or socket wrench, etc., the release piston is pushed back and the lock is released. Since the lever will return to its original position and become locked again when it is released, it should be held in this position for as long as unlocking is required.



CNS Series Specific Product Precautions 4

Be sure to read this before handling the products.

Refer to back page 50 for Safety Instructions and pages 3 to 12 for Actuator and Auto Switch Precautions.

Maintenance

⚠ Caution

1. Lock units for the CNS series are replaceable.

To order replacement lock units for the CNS series, use the order numbers given in the table below.

Bore size (mm)	Lock unit part no.
125	CNS125D-UA
140	CNS140D-UA
160	CNS160D-UA

2. How to replace lock unit

- Loosen the tie-rod nuts (4 pcs.) in the cylinder rod side by using a socket wrench.
For the applicable socket, refer to the table below.

Bore size (mm)	Nut	Width across flats	Socket
125, 140	JIS B 1181 Class 2 M14 x 1.5	22	JIS B 4636 socket 22
160	JIS B 1181 Class 2 M16 x 1.5	24	JIS B 4636 socket 24

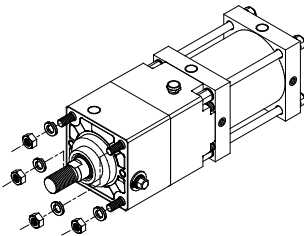

- Apply compressed air of 0.3 MPa or more to the unlocking port, and remove the lock unit.

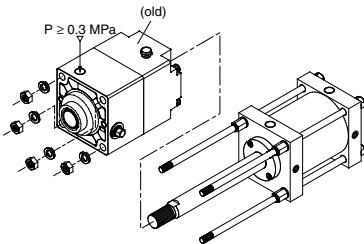

- Similarly, apply 0.3 MPa or more of compressed air to the unlocking port of the new lock unit, and replace the new lock unit's temporary axis with the previous piston rod assembly.

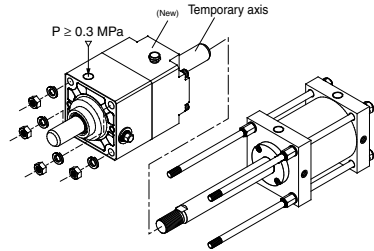

- Tighten the tie-rod nuts (4 pcs.) on the rod side of the cylinder using a socket wrench.

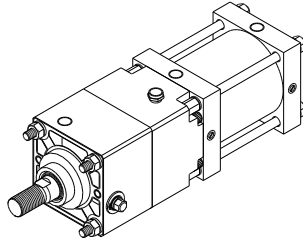

⚠ Warning

Never disassemble a lock unit of CNS series.

- Since a heavy duty spring is contained in the unit, there is a serious hazard, such as the possibility of parts being ejected, if disassembly is performed incorrectly. Therefore, do not loosen or remove the hexagon socket head cap screws which secure cover A and cover B.
- Be sure to contact SMC regarding disassembly or repair, etc.

CLJ2

CLM2

CLG1

CL1

MLGC

CNG

MNB

CNA2

CNS

CLS

CLQ

RLQ

MLU

MLGP

ML1C

D-□

-X□