

# Compact Cylinder with Lock

## CLQ Series

ø20, ø25, ø32, ø40, ø50, ø63, ø80, ø100

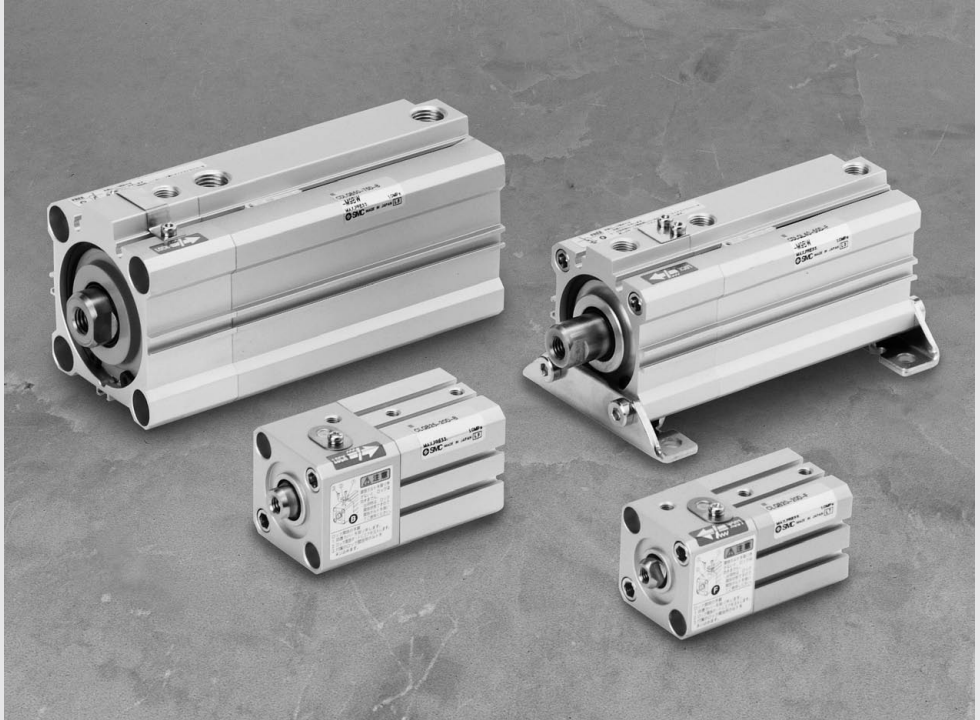

CLJ2
CLM2
CLG1
CL1
MLGC
CNG
MNB
CNA2
CNS
CLS
<b>CLQ</b>
RLQ
MLU
MLGP
ML1C

Drop prevention when the pressure of air source is decreased or the residual pressure is released.

Drop prevention for press fitting attachment  
Extension locking

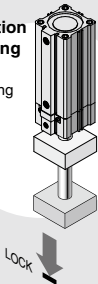

Drop prevention for lifter  
Retracting locking

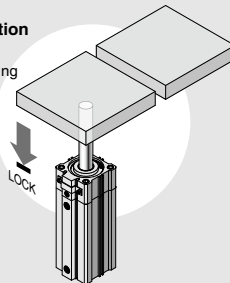

Holding a clamped condition  
Retracting locking

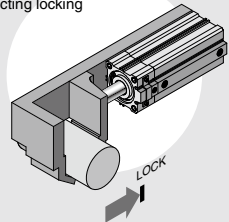

D-□
-X□

# CLQ Series Compact Cylinder

**Drop prevention is possible within the entire stroke at any position.**

- Drop prevention in the middle of stroke
- Locking position can be changed in accordance with the external stopper position and the thickness of clamped workpieces.

Drop prevention for press fitting attachment

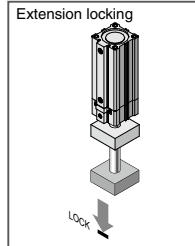

Drop prevention for lifter

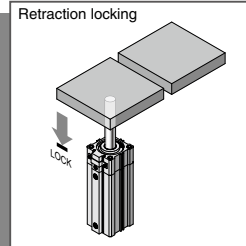

Holding a clamped condition

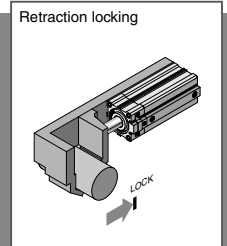

## Simple Construction/Simple and reliable locking type

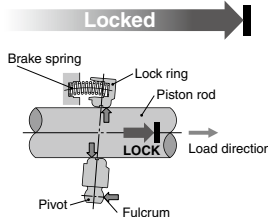
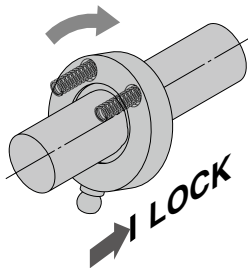

### Unlocking port: Air exhausted

1. The lock ring is tilted by the spring force.
2. The tilting is increased by the load and the piston rod is securely locked.

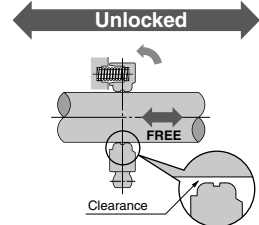

### Unlocking port: Air supplied

1. The lock ring becomes perpendicular to the piston, creating clearance between the piston rod and lock ring, which allows the piston rod to move freely.

# with Lock

∅20, ∅25, ∅32, ∅40, ∅50, ∅63, ∅80, ∅100

## Low profile with compact lock unit

- Lock unit length

**27 mm to 50 mm**

- The lock unit does not project beyond the cylinder's external dimensions

Thickness of Lock Unit (mm)

Bore size (mm)	A
20	27
25	31
32	32
40	34
50	35
63	38
80	43
100	50

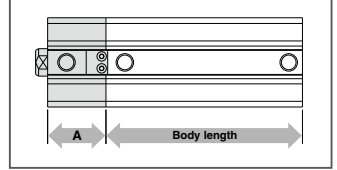

## Locking direction is selectable

Extension locking

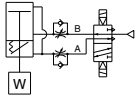

Retraction locking

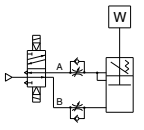

\* The symbol for the cylinder with lock in the pneumatic circuit uses SMC original symbol.



## Two types of mounting

Through-hole mounting

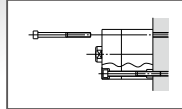

Both ends tapped

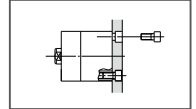

## Easy manual unlocking

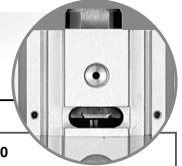

Locked

∅20 to ∅32    ∅40 to ∅100

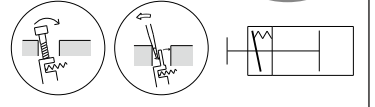

Unlocked

∅20 to ∅32    ∅40 to ∅100

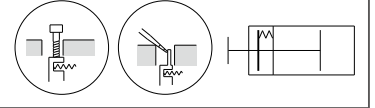

## Wide Size Variations from ∅20 to ∅100

Series	Mounting	Locking direction	Bore size (mm)	Standard stroke (mm)														
				5	10	15	20	25	30	35	40	45	50	75	100			
CLQ	Through-hole/ Both ends tapped common	Extension locking	20	●	●	●	●	●	●	●	●	●	●	●	●	●	●	
			25	●	●	●	●	●	●	●	●	●	●	●	●	●	●	
			32	●	●	●	●	●	●	●	●	●	●	●	●	●	●	●
			40	●	●	●	●	●	●	●	●	●	●	●	●	●	●	●
	Through-hole Both ends tapped type	Retraction locking	50	●	●	●	●	●	●	●	●	●	●	●	●	●	●	
			63	●	●	●	●	●	●	●	●	●	●	●	●	●	●	
			80	●	●	●	●	●	●	●	●	●	●	●	●	●	●	●
			100	●	●	●	●	●	●	●	●	●	●	●	●	●	●	●

- CLJ2
- CLM2
- CLG1
- CL1
- MLGC
- CNG
- MNB
- CNA2
- CNS
- CLS
- CLQ
- RLQ
- MLU
- MLGP
- ML1C

- D-□
- X□

# Compact Cylinder with Lock Double Acting, Single Rod

# CLQ Series

ø20, ø25, ø32, ø40, ø50, ø63, ø80, ø100

## How to Order

**CLQ B 40 - 30 D - F -**

**With auto switch** **CDLQ B 40 - 30 D - F - M9BW -**

**With auto switch (Built-in magnet)**

**Mounting type**

<b>B</b> Through-hole/ Both ends tapped common (Standard)	<b>A</b> Through-hole (Standard)
<b>L</b> Foot type	<b>A</b> Both ends tapped type
<b>F</b> Rod side flange type	<b>L</b> Foot type
<b>G</b> Head side flange type	<b>F</b> Rod side flange type
<b>D</b> Double clevis type	<b>G</b> Head side flange type
	<b>D</b> Double clevis type

**Bore size**

<b>20</b> 20 mm	<b>50</b> 50 mm
<b>25</b> 25 mm	<b>63</b> 63 mm
<b>32</b> 32 mm	<b>80</b> 80 mm
<b>40</b> 40 mm	<b>100</b> 100 mm

**Port thread type**

<b>Nil</b> Rc.M (ø20, ø25)	
<b>TN</b> NPT	
<b>TF</b> G	

**Auto switch**

<b>Nil</b> Without auto switch	
--------------------------------	--

**Locking direction**

<b>F</b> Extension locking	
<b>B</b> Retraction locking	

**Body option**

<b>Nil</b> Standard (Rod end female thread)	
<b>C</b> With rubber bumper	
<b>M</b> Rod end male thread	
<b>CM</b> With rubber bumper, Rod end male thread	

**Action**

<b>D</b> Double acting	
------------------------	--

**Number of auto switches**

<b>Nil</b> 2 pcs.	
<b>S</b> 1 pc.	
<b>n</b> "n" pcs.	

**Cylinder stroke (mm)**

**Made to Order** Refer to page 1009 for details.

\* For the applicable auto switch model, refer to the table below.

\* Mounting bracket is shipped together, (but not assembled).

\* Cylinder mounting bolts are not included. Order them separately referring to "Mounting Bolt for CDLQB" on page 1011.

### Built-in Magnet Cylinder Model

If a built-in magnet cylinder without an auto switch is required, there is no need to enter the symbol for the auto switch. (Example) CDLQL32-30D-B

### Applicable Auto Switches

Refer to pages 1119 to 1245 for detailed specifications of auto switches.

Type	Special function	Electrical entry	Indicator light	Wiring (Output)	Load voltage		Auto switch model				Lead wire length (m)					Pre-wired connector	Applicable load			
					DC	AC	Perpendicular ø20, ø25	In-line ø20, ø25	0.5 (Nil)	1 (M)	3 (L)	5 (Z)	None (N)							
Solid state auto switch	—	Grommet	Yes	3-wire (NPN)	5 V,	—	M9NV	M9N	●	●	○	—	○	IC circuit	Relay, PLC					
				3-wire (PNP)	12 V		M9PV	M9P	●	●	○	—								
		2-wire		12 V	M9BV		M9B	●	●	○	—									
	—	—		J79C	—		●	—	●	—										
	3-wire (NPN)	5 V,		M9NVW	M9NW		●	●	○	—										
	3-wire (PNP)	12 V		M9PVW	M9PW		●	●	○	—										
	2-wire	12 V	M9BWW	M9BW	●		●	○	—											
	Water resistant (2-color indicator)	Grommet	Yes	3-wire (NPN)	5 V,		M9NAV <sup>*1</sup>	M9NA <sup>*1</sup>	○	○	●	○	—			○	IC circuit	Relay, PLC		
				3-wire (PNP)	12 V		M9PAV <sup>*1</sup>	M9PA <sup>*1</sup>	○	○	●	○								
				2-wire	12 V		M9BAV <sup>*1</sup>	M9BA <sup>*1</sup>	○	○	●	○								
With diagnostic output (2-color indicator)	Grommet	Yes		4-wire	5 V, 12 V	—	F79F	—	●	—	●	—	○	IC circuit	Relay, PLC					
				2-wire (Non-polar)	—	—	P3DWA <sup>**</sup>	—	●	—	●	—								
Magnetic field resistant (2-color indicator)	Grommet			Yes	2-wire	—	—	P4DW	—	●	—	●	—	○		IC circuit	Relay, PLC			
			—		Grommet	Yes	3-wire (NPN equivalent)	5 V	A96V	A96	●	—	●	—				—	IC circuit	Relay, PLC
							—	—	200V	A72	—	A72H	●	—				●		
12 V	100V						A93V <sup>*2</sup>	A93	●	●	●	—	—							
Diagnostic indication (2-color indicator)	Grommet	Yes	2-wire		5 V, 12 V		100 V or less	A90V	A90	●	—	●	—	—	IC circuit	Relay, PLC				
			—		—		—	A73C	—	—	—	—	—							
			5 V, 12 V	24 V or less	A80C		—	●	—	●	—	—								
			—	—	A79W	—	●	—	●	—	—									

\*1 Water resistant type auto switches can be mounted on the above models, but in such case SMC cannot guarantee water resistance. Consult with SMC regarding water resistant types with the above model numbers.

\*2 2 m type lead wire is only applicable to D-A93.

\* Lead wire length symbols: 0.5 m ..... Nil (Example) M9NW  
1 m ..... M (Example) M9NWM  
3 m ..... L (Example) M9NWL  
5 m ..... Z (Example) M9NWZ  
None ..... N (Example) J79CN

\* Solid state auto switches marked with "○" are produced upon receipt of order.  
\* D-P4DW is compatible with ø40 to ø100.  
\* D-P4DW is assembled at the time of shipment.  
\* D-P3DWA□ is compatible with ø25 to ø100.  
\* For ø25, it is mounted away from the port side to avoid interference with fittings.

\* Since there are other applicable auto switches than listed, refer to page 1029 for details.

\* For details about auto switches with pre-wired connector, refer to pages 1192 and 1193.

\* When D-A9□(V)/M9□(V)/M9□W(V)/M9□A(V) types with ø32 to ø50 are mounted on a side other than the port side, order auto switch mounting brackets separately. Refer to page 1028 for details.

\* When mounting brackets (foot/head side flange/double clevis type) are used, then in some cases auto switch cannot be retrofitted.

## Cylinder Specifications

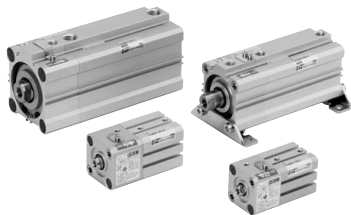

Bore size (mm)	20	25	32	40	50	63	80	100
Action	Double acting, Single rod							
Fluid	Air							
Proof pressure	1.5 MPa							
Maximum operating pressure	1.0 MPa							
Minimum operating pressure	0.2 MPa <sup>Note 1)</sup>							
Ambient and fluid temperature	Without auto switch: -10 to 70°C (No freezing) With auto switch: -10 to 60°C (No freezing)							
Lubrication	Not required (Non-lube)							
Piston speed	50 to 500 mm/s							
Stroke length tolerance	$^{+1.0}_{-0}$ mm <sup>Note 2)</sup>							
Cushion	None, rubber bumper							
Port size (Rc, NPT, G)	M5 x 0.8	1/8		1/4		3/8		

Note 1) The minimum operating pressure of the cylinder is 0.1 MPa when the cylinder and lock are connected to separate ports.

Note 2) Stroke length tolerance does not include the amount of bumper change.

## Lock Specifications

Bore size (mm)	20	25	32	40	50	63	80	100
Locking action	Spring locking (Exhaust locking)							
Unlocking pressure	0.2 MPa or more							
Lock starting pressure	0.05 MPa or less							
Locking direction	One direction (Either extension locking or retraction locking)							
Unlocking port size	Rc	M5 x 0.8		1/8			1/4	
	NPT	—		M5 x 0.8			1/8 1/4	
	G	—		M5 x 0.8			1/8 1/4	
Holding force <sup>(Note)</sup> (N) (Maximum static load)	157	245	402	629	982	1559	2513	3927
	Equivalent to 0.5 MPa							

Note) The holding force (max. static load) shows the maximum capability and does not show the normal holding capability. So, select an appropriate cylinder while referring to page 1030.

## Standard Stroke

Bore size (mm)	Standard stroke (mm)
20, 25	5, 10, 15, 20, 25, 30, 35, 40, 45, 50
32, 40, 50, 63, 80, 100	10, 15, 20, 25, 30, 35, 40, 45, 50, 75, 100

## Manufacture of Intermediate Stroke

Description	Spacer is installed in the standard stroke body.	
Part no.	Refer to "How to Order" for the standard model no. on page 1008.	
Method	Dealing with the stroke in 1 mm increments is available by installing spacer with standard stroke cylinder.	
Stroke range	Bore size (mm)	Stroke range (mm)
	20, 25	1 to 50
	32, 40, 50, 63, 80, 100	1 to 100
Example	Part no.: CLQB40-47D-B 3 mm spacer is installed in standard cylinder CLQB40-50D-B. B dimension is 79.5 mm.	

Note) ø40 to ø100 bumper spacers with intermediate strokes can be manufactured in 5 mm increments from 55 to 95 mm.



**Made to Order Specifications**  
[Click here for details](#)

Symbol	Specifications
-XA□	Change of rod end shape
-XC35	With coil scraper (ø40 to ø100 only)
-XC87	Heavy duty (ø40 to ø100 only)

Refer to pages 1026 to 1029 for cylinders with auto switches.

- Minimum auto switch mounting stroke
- Proper auto switch mounting position (detection at stroke end) and mounting height
- Operating range
- Auto switch mounting bracket: Part no.

CLJ2

CLM2

CLG1

CL1

MLGC

CNG

MNB

CNA2

CNS

CLS

CLQ

RLQ

MLU

MLGP

ML1C

D-□

-X□

## Mounting Bracket Part No.

Bore size (mm)	Foot (1)	Flange	Double clevis
20	CLQ-L020	CLQ-F020	CLQ-D020
25	CLQ-L025	CLQ-F025	CLQ-D025
32	CLQ-L032	CLQ-F032	CLQ-D032
40	CLQ-L040	CLQ-F040	CLQ-D040
50	CLQ-L050	CLQ-F050	CLQ-D050
63	CLQ-L063	CLQ-F063	CLQ-D063
80	CLQ-L080	CLQ-F080	CLQ-D080
100	CLQ-L100	CLQ-F100	CLQ-D100

Note 1) When ordering foot bracket, order 2 pieces per cylinder.

Note 2) Parts belonging to each bracket are as follows. Foot, Flange: Body mounting screws, Double clevis: Clevis pin, type C retaining ring for shaft, Body mounting screws, Flat washer.

## Theoretical Output



Bore size (mm)	Operating direction	Operating pressure (MPa)		
		0.3	0.5	0.7
		(N)		
20	IN	71	118	165
	OUT	94	157	220
25	IN	113	189	264
	OUT	147	245	344
32	IN	181	302	422
	OUT	241	402	563
40	IN	317	528	739
	OUT	377	628	880
50	IN	495	825	1150
	OUT	589	982	1370
63	IN	841	1400	1960
	OUT	935	1560	2180
80	IN	1360	2270	3170
	OUT	1510	2510	3520
100	IN	2140	3570	5000
	OUT	2360	3930	5500

## Weight

### Basic Weight: Mounting/Through-hole (Type B)

Bore size (mm)	Standard stroke (mm)											
	5	10	15	20	25	30	35	40	45	50	75	100
20 *	184	199	213	227	241	255	270	284	298	312	—	—
25 *	260	278	295	312	329	346	364	381	398	415	—	—
32	—	407	430	453	475	498	521	544	566	589	754	867
40	—	514	537	560	583	606	630	653	676	699	883	1003
50	—	838	874	910	947	983	1019	1055	1092	1128	1421	1609
63	—	1202	1242	1283	1324	1365	1406	1447	1488	1529	1877	2088
80	—	2229	2297	2364	2432	2500	2568	2636	2704	2771	3344	3678
100	—	3770	3860	3951	4041	4132	4223	4313	4404	4495	5299	5759

\* Through-hole and both ends tapped are common for sizes ø20 and ø25.

### Basic Weight:

#### Mounting/Both Ends Tapped (Type A)

Bore size (mm)	Standard stroke (mm)										
	10	15	20	25	30	35	40	45	50	75	100
32	405	429	453	475	499	523	546	569	593	763	879
40	542	568	593	619	644	670	695	721	746	947	1079
50	883	922	962	1002	1041	1081	1121	1161	1200	1517	1723
63	1330	1377	1424	1471	1518	1565	1613	1660	1707	2099	2341
80	2468	2545	2623	2700	2778	2856	2933	3011	3089	3729	4113
100	4054	4154	4254	4355	4455	4556	4656	4757	4857	5730	6239

### Additional Weight

Bore size (mm)	20	25	32	40	50	63	80	100
Magnet	35	45	64	77	118	158	261	380
Rod end male thread	Thread	6	12	26	27	53	120	175
	Nut	4	8	17	17	32	32	49
With rubber bumper	-2	-3	-3	-7	-9	-18	-31	-56
Foot type (Including mounting bolt)	152	174	137	149	221	288	638	1009
Rod side flange type (Including mounting bolt)	127	149	174	208	351	523	998	1307
Head side flange type (Including mounting bolt)	121	140	159	192	326	498	959	1251
Double clevis type (Including pin, snap ring, bolt and flat washer)	76	111	145	190	373	518	1064	1839

Calculation: (Example) **CDLQD32-20DCM-B**  
 • Basic weight : CLQA32-20D-□ ..... 453 g  
 • Additional weight: Magnet ..... 64 g  
 Rod end male thread ..... 43 g  
 With rubber bumper ..... -3 g  
 Double clevis ..... 145 g

When auto switches are mounted, add the weight of the auto switch and auto switch mounting bracket multiplied by the quantity.

### Auto Switch Mounting Bracket Weight

Auto Switch mounting bracket part no.	Applicable bore size (mm)	Weight (g)
<b>BQ-2</b>	ø32 to ø100	1.5
<b>BQ2-012</b>	ø32 to ø100	5
<b>BQP1-050</b>	ø40 to ø100	16

For the auto switch weight, refer to page 1119. Refer to pages 1028 and 1029 for applicable auto switch mounting brackets.

### Mounting Bolt for C□LQB

Mounting method: Mounting bolt for through-hole mounting  
Refer to the following for ordering procedures.  
Order the actual number of bolts that will be used.

**Example) CQ-M5 x 55L 2 pcs.**

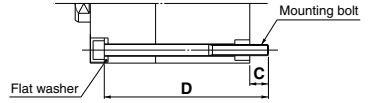

Note) Be sure to use the attached flat washers as the bearing surface is small when mounting ø50 to ø100 cylinders from the rod side.

### CLQB: Without Auto Switch

Cylinder model	C	D	Mounting bolt part no.
<b>CLQB20-5D</b>	10.5	55	CQ-M5 x 55 L
-10D		60	x 60 L
-15D		65	x 65 L
-20D		70	x 70 L
-25D		75	x 75 L
-30D		80	x 80 L
-35D		85	x 85 L
-40D		90	x 90 L
-45D		95	x 95 L
-50D		100	x 100 L
<b>CLQB25-5D</b>	8.5	60	CQ-M5 x 60 L
-10D		65	x 65 L
-15D		70	x 70 L
-20D		75	x 75 L
-25D		80	x 80 L
-30D		85	x 85 L
-35D		90	x 90 L
-40D		95	x 95 L
-45D		100	x 100 L
-50D		105	x 105 L

Cylinder model	C	D	Mounting bolt part no.
<b>CLQB32-10D</b>	7	65	CQ-M5 x 65 L
-15D		70	x 70 L
-20D		75	x 75 L
-25D		80	x 80 L
-30D		85	x 85 L
-35D		90	x 90 L
-40D		95	x 95 L
-45D		100	x 100 L
-50D		105	x 105 L
-75D		140	x 140 L
-100D	165	x 165 L	
<b>CLQB40-10D</b>	8.5	75	CQ-M5 x 75 L
-15D		80	x 80 L
-20D		85	x 85 L
-25D		90	x 90 L
-30D		95	x 95 L
-35D		100	x 100 L
-40D		105	x 105 L
-45D		110	x 110 L
-50D		115	x 115 L
-75D		150	x 150 L
-100D	175	x 175 L	

Cylinder model	C	D	Mounting bolt part no.
<b>CLQB50-10D</b>	12.5	80	CQ-M6 x 80 L
-15D		85	x 85 L
-20D		90	x 90 L
-25D		95	x 95 L
-30D		100	x 100 L
-35D		105	x 105 L
-40D		110	x 110 L
-45D		115	x 115 L
-50D		120	x 120 L
-75D		155	x 155 L
-100D	180	x 180 L	
<b>CLQB63-10D</b>	16.5	90	CQ-M8 x 90 L
-15D		95	x 95 L
-20D		100	x 100 L
-25D		105	x 105 L
-30D		110	x 110 L
-35D		115	x 115 L
-40D		120	x 120 L
-45D		125	x 125 L
-50D		130	x 130 L
-75D		165	x 165 L
-100D	190	x 190 L	

Cylinder model	C	D	Mounting bolt part no.
<b>CLQB80-10D</b>	17	100	CQ-M10 x 100 L
-15D		105	x 105 L
-20D		110	x 110 L
-25D		115	x 115 L
-30D		120	x 120 L
-35D		125	x 125 L
-40D		130	x 130 L
-45D		135	x 135 L
-50D		140	x 140 L
-75D		175	x 175 L
-100D	200	x 200 L	
<b>CLQB100-10D</b>	15.5	115	CQ-M10 x 115 L
-15D		120	x 120 L
-20D		125	x 125 L
-25D		130	x 130 L
-30D		135	x 135 L
-35D		140	x 140 L
-40D		145	x 145 L
-45D		150	x 150 L
-50D		155	x 155 L
-75D		190	x 190 L
-100D	215	x 215 L	

### CDLQB: Without Auto Switch

Cylinder model	C	D	Mounting bolt part no.
<b>CDLQB20-5D</b>	10.5	65	CQ-M5 x 65 L
-10D		70	x 70 L
-15D		75	x 75 L
-20D		80	x 80 L
-25D		85	x 85 L
-30D		90	x 90 L
-35D		95	x 95 L
-40D		100	x 100 L
-45D		105	x 105 L
-50D		110	x 110 L
<b>CDLQB25-5D</b>	8.5	70	CQ-M5 x 70 L
-10D		75	x 75 L
-15D		80	x 80 L
-20D		85	x 85 L
-25D		90	x 90 L
-30D		95	x 95 L
-35D		100	x 100 L
-40D		105	x 105 L
-45D		110	x 110 L
-50D		115	x 115 L

Cylinder model	C	D	Mounting bolt part no.
<b>CDLQB32-10D</b>	7	75	CQ-M5 x 75 L
-15D		80	x 80 L
-20D		85	x 85 L
-25D		90	x 90 L
-30D		95	x 95 L
-35D		100	x 100 L
-40D		105	x 105 L
-45D		110	x 110 L
-50D		115	x 115 L
-75D		140	x 140 L
-100D	165	x 165 L	
<b>CDLQB40-10D</b>	8.5	85	CQ-M5 x 85 L
-15D		90	x 90 L
-20D		95	x 95 L
-25D		100	x 100 L
-30D		105	x 105 L
-35D		110	x 110 L
-40D		115	x 115 L
-45D		120	x 120 L
-50D		125	x 125 L
-75D		150	x 150 L
-100D	175	x 175 L	

Cylinder model	C	D	Mounting bolt part no.
<b>CDLQB50-10D</b>	12.5	90	CQ-M6 x 90 L
-15D		95	x 95 L
-20D		100	x 100 L
-25D		105	x 105 L
-30D		110	x 110 L
-35D		115	x 115 L
-40D		120	x 120 L
-45D		125	x 125 L
-50D		130	x 130 L
-75D		155	x 155 L
-100D	180	x 180 L	
<b>CDLQB63-10D</b>	16.5	100	CQ-M8 x 100 L
-15D		105	x 105 L
-20D		110	x 110 L
-25D		115	x 115 L
-30D		120	x 120 L
-35D		125	x 125 L
-40D		130	x 130 L
-45D		135	x 135 L
-50D		140	x 140 L
-75D		165	x 165 L
-100D	190	x 190 L	

Cylinder model	C	D	Mounting bolt part no.
<b>CDLQB80-10D</b>	17	110	CQ-M10 x 110 L
-15D		115	x 115 L
-20D		120	x 120 L
-25D		125	x 125 L
-30D		130	x 130 L
-35D		135	x 135 L
-40D		140	x 140 L
-45D		145	x 145 L
-50D		150	x 150 L
-75D		175	x 175 L
-100D	200	x 200 L	
<b>CDLQB100-10D</b>	15.5	125	CQ-M10 x 125 L
-15D		130	x 130 L
-20D		135	x 135 L
-25D		140	x 140 L
-30D		145	x 145 L
-35D		150	x 150 L
-40D		155	x 155 L
-45D		160	x 160 L
-50D		165	x 165 L
-75D		190	x 190 L
-100D	215	x 215 L	

- CLJ2
- CLM2
- CLG1
- CL1
- MLGC
- CNG
- MNB
- CNA2
- CNS
- CLS
- CLQ
- RLQ
- MLU
- MLGP
- ML1C

- D-□
- X□

# CLQ Series

Construction:  $\phi 20$  to  $\phi 32$

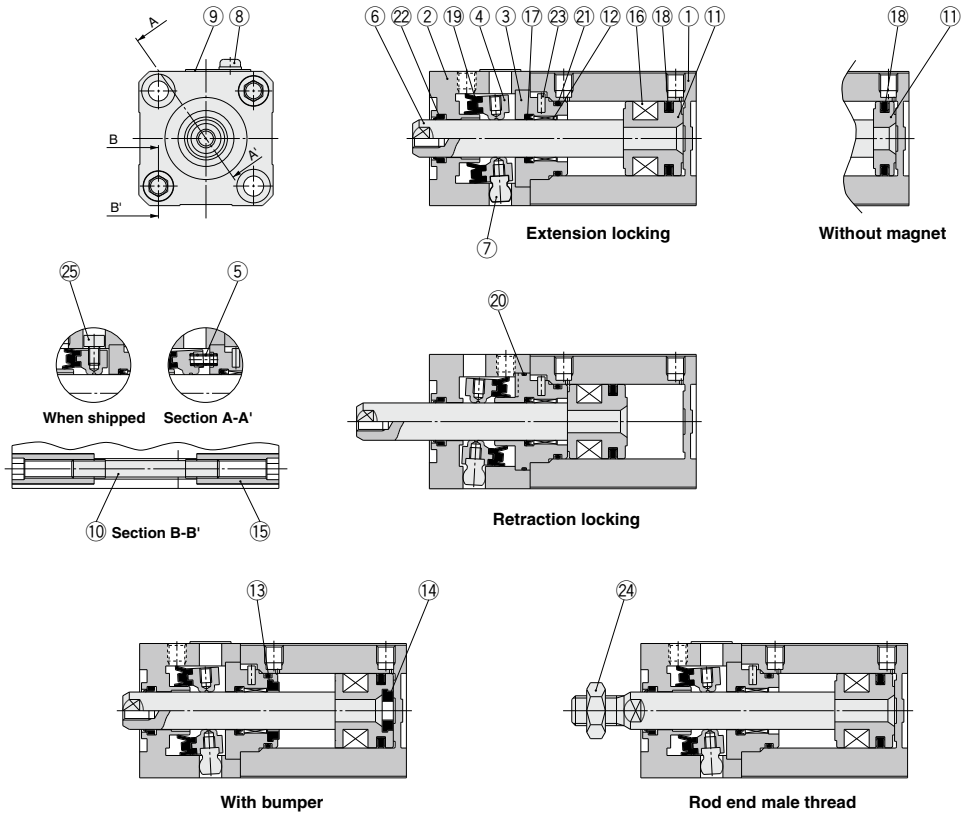

Note) The sectional drawing above shows the locked condition. (A bolt is used to maintain the cylinder in the unlocked condition when shipped.)

## Component Parts

No.	Description	Material	Note
1	Cylinder tube	Aluminum alloy	Hard anodized
2	Lock body	Aluminum alloy	Hard anodized
3	Intermediate collar	Aluminum alloy	Extension locking: Chromated Retraction locking: Hard anodized
4	Lock ring	Carbon steel	Heat treated
5	Brake spring	Steel wire	Zinc chromated
6	Piston rod	Stainless steel	$\phi 20, 25$ : Hard chrome plated
		Carbon steel	$\phi 32$ : Hard chrome plated
7	Pivot	Chromium molybdenum steel	Electroless nickel plated
8	Dust cover holding bolt	Carbon steel	
9	Dust cover	Stainless steel	
10	Tie-rod	Rolled steel	$\phi 20$ : Nickel plated
			$\phi 25$ : Zinc chromated
			$\phi 32$ : Black zinc chromated
11	Piston	Aluminum alloy	

No.	Description	Material	Note
12	Bushing	Bearing alloy	
13	Bumper A	Urethane	
14	Bumper B	Urethane	
15	Tie-rod nut	Carbon steel	Nickel plated
16	Magnet	—	
17	Rod seal	NBR	
18	Piston seal	NBR	
19	Lock ring seal	NBR	
20	Tube gasket A	NBR	
21	Tube gasket B	NBR	
22	Scraper	NBR	
23	Parallel pin	Stainless steel	JIS B 1354
24	Rod end nut	Carbon steel	
25	Unlocking bolt	Chromium molybdenum steel	



Construction:  $\phi 40$  to  $\phi 100$

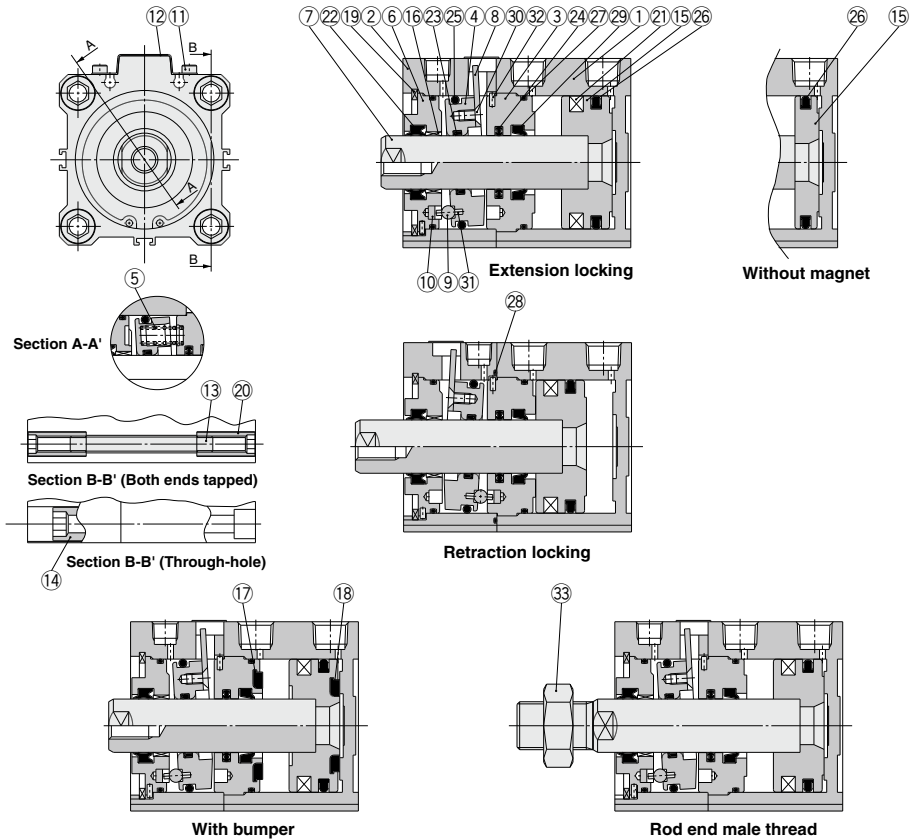

- CLJ2
- CLM2
- CLG1
- CL1
- MLGC
- CNG
- MNB
- CNA2
- CNS
- CLS
- CLQ**
- RLQ
- MLU
- MLGP
- ML1C

Component Parts

No.	Description	Material	Note
1	Cylinder tube	Aluminum alloy	Hard anodized
2	Lock body	Aluminum alloy	Hard anodized
3	Intermediate collar	Aluminum alloy	Chromated
4	Lock ring	Carbon steel	Heat treated
5	Brake spring	Steel wire	Zinc chromated
6	Collar	Aluminum bearing alloy Aluminum alloy casted	$\phi 40$ : Hard anodized $\phi 50$ to $\phi 100$ : Chromated, painted
7	Piston rod	Carbon steel	Hard chrome plated
8	Lever	Stainless steel	
9	Pivot pin	Carbon steel	Zinc chromated
10	Pivot key	Carbon steel	Zinc chromated
11	Dust cover holding bolt	Chromium molybdenum steel	
12	Dust cover	Rolled steel	
13	Tie-rod	Rolled steel Carbon steel	$\phi 40$ , Zinc chromated $\phi 50$ or larger, Zinc chromated
14	Unit holding bolt	Carbon steel	Nickel plated
15	Piston	Aluminum alloy	
16	Bushing	Bearing alloy	For $\phi 50$ or larger only

Note) The sectional drawing above shows the locked condition.

No.	Description	Material	Note
17	Bumper A	Urethane	
18	Bumper B	Urethane	
19	Retaining ring	Carbon tool steel	Phosphate coated
20	Tie-rod nut	Carbon steel	$\phi 40$ , Nickel plated $\phi 50$ to $\phi 100$ , Zinc chromated
21	Magnet	—	
22	Rod seal A	NBR	
23	Rod seal B	NBR	
24	Rod seal C	NBR	
25	Piston seal A	NBR	
26	Piston seal B	NBR	
27	Tube gasket A	NBR	
28	Tube gasket B	NBR	
29	Scrapor	NBR	
30	Hexagon socket countersunk head screw	Chromium molybdenum steel	
31	Spring pin	Carbon steel	JIS B 2808
32	Parallel pin	Stainless steel	JIS B 1354
33	Rod end nut	Carbon steel	

- D
- X

# CLQ Series

Dimensions:  $\phi 20$ ,  $\phi 25$

Basic type (Through-hole/Both ends tapped common): C□LQB20/25

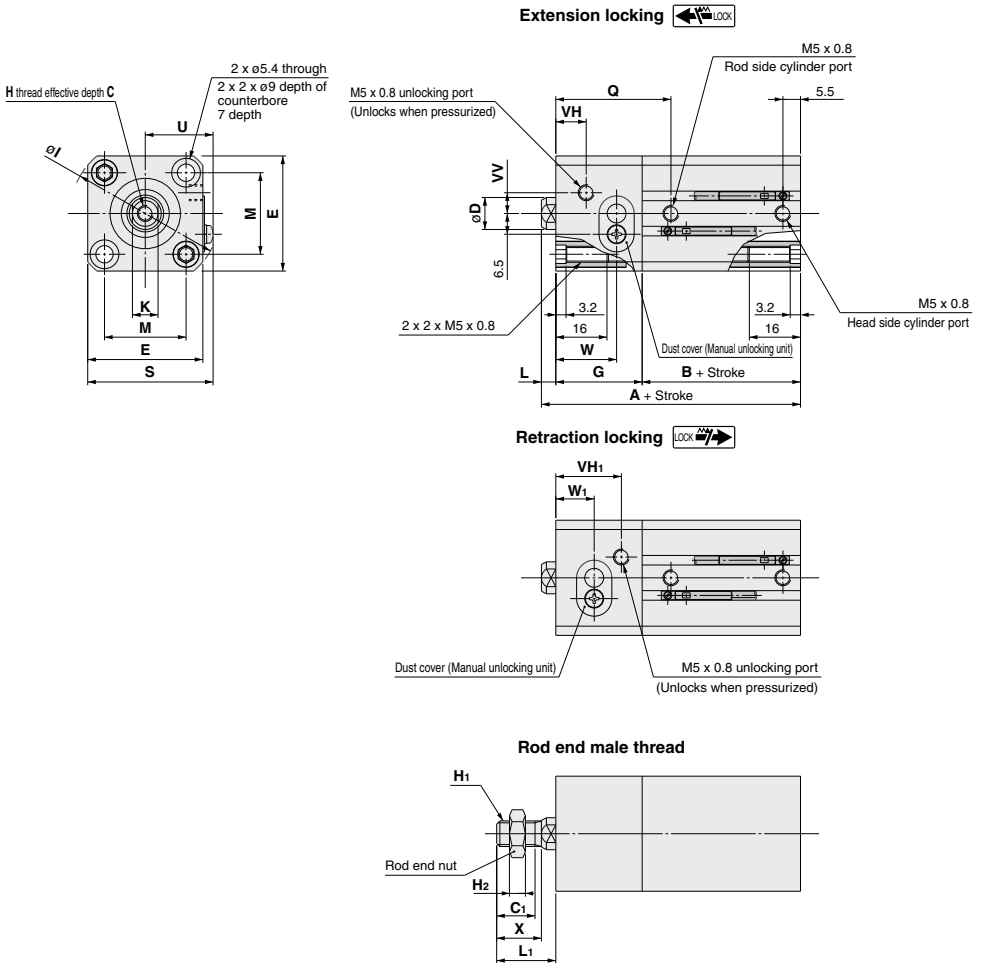

Bore size (mm)	Stroke range	Without auto switch		With auto switch		C	D	E	G	H	I	K	L	M	Q	S	U	VH	VV	W
		A	B	A	B															
20	5 to 50	51	19.5	61	29.5	7	10	36	27	M5 x 0.8	47	8	4.5	25.5	36	39.2	21.2	9.5	6.5	19
25	5 to 50	58.5	22.5	68.5	32.5	12	12	40	31	M6 x 1.0	52	10	5	28	42	43.2	23.2	10	7	21.5

## Retraction Locking (mm)

Bore size (mm)	VH <sub>1</sub>	W <sub>1</sub>
20	20.5	12
25	23	14.5

## Rod End Male Thread (mm)

Bore size (mm)	C <sub>1</sub>	X	H <sub>1</sub>	H <sub>2</sub>	L <sub>1</sub>
20	12	14	M8 x 1.25	5	18.5
25	15	17.5	M10 x 1.25	6	22.5

\* Dimensions for cylinders with a rubber bumper are the same as the standard type above.  
 \*\* Refer to page 1024 for details of rod end nuts and accessory brackets.

**Dimensions:  $\varnothing 20, \varnothing 25$**

**Foot type: CLQL/CDLQL**

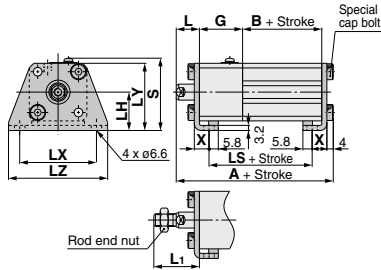

**Foot Type**

(mm)

Bore size (mm)	Stroke range	Without auto switch			With auto switch		
		A	B	LS	A	B	LS
20	5 to 50	68.2	19.5	34.5	78.2	29.5	44.5
25	5 to 50	75.7	22.5	38.5	85.7	32.5	48.5

Bore size (mm)	G	L	L <sub>1</sub>	LH	LX	LY	LZ	S	X
	20	27	14.5	28.5	24	48	42	62	45.2
25	31	15	32.5	26	52	46	66	49.2	10.7

Foot bracket material: Carbon steel  
Surface treatment: Nickel plated

**Rod side flange type: CLQF/CDLQF**

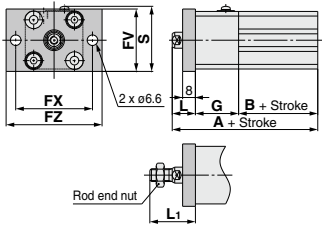

**Rod Side Flange Type**

(mm)

Bore size (mm)	Stroke range	Without auto switch		With auto switch	
		A	B	A	B
20	5 to 50	61	19.5	71	29.5
25	5 to 50	68.5	22.5	78.5	32.5

Bore size (mm)	FV	FX	FZ	G	L	L <sub>1</sub>	S
	20	39	48	60	27	14.5	28.5
25	42	52	64	31	15	32.5	44.2

Flange bracket material: Carbon steel  
Surface treatment: Nickel plated

**Head side flange type: CLQG/CDLQG**

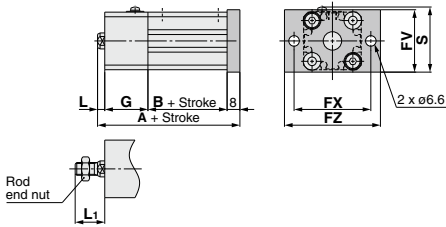

**Head Side Flange Type**

(mm)

Bore size (mm)	Stroke range	Without auto switch		With auto switch	
		A	B	A	B
20	5 to 50	59	19.5	69	29.5
25	5 to 50	66.5	22.5	76.5	32.5

Bore size (mm)	FV	FX	FZ	G	L	L <sub>1</sub>	S
	20	39	48	60	27	4.5	18.5
25	42	52	64	31	5	22.5	44.2

Flange bracket material: Carbon steel  
Surface treatment: Nickel plated

**Double clevis type: CLQD/CDLQD**

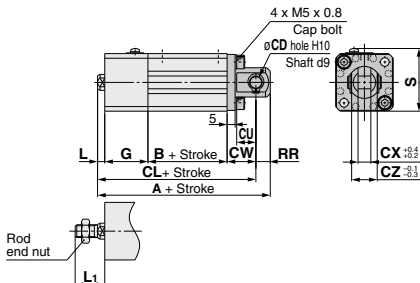

**Double Clevis Type**

(mm)

Bore size (mm)	Stroke range	Without auto switch			With auto switch		
		A	B	CL	A	B	CL
20	5 to 50	78	19.5	69	88	29.5	79
25	5 to 50	88.5	22.5	78.5	98.5	32.5	88.5

Bore size (mm)	CD	CU	CW	CX	CZ	G	L	L <sub>1</sub>	RR	S
	20	8	12	18	8	16	27	4.5	18.5	9
25	10	14	20	10	20	31	5	22.5	10	43.2

\* Refer to page 1024 for details of rod end nuts and accessory brackets.

Double clevis bracket material: Carbon steel  
Surface treatment: Nickel plated

\*\* Double clevis pins and retaining rings are included.

- CLJ2
- CLM2
- CLG1
- CL1
- MLGC
- CNG
- MNB
- CNA2
- CNS
- CLS
- CLQ
- RLQ
- MLU
- MLGP
- ML1C

- D-
- X

# CLQ Series

## Dimensions: $\phi 32$

### Both ends tapped type: C□LQA32

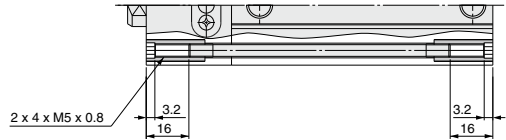

### Basic type (Through-hole): C□LQB32

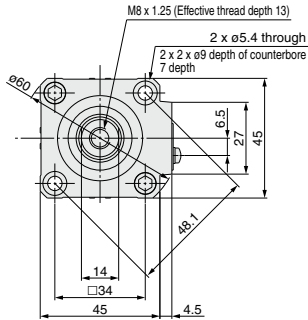

#### Extension locking

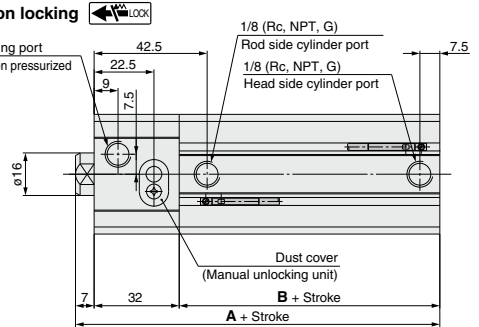

#### Retraction locking

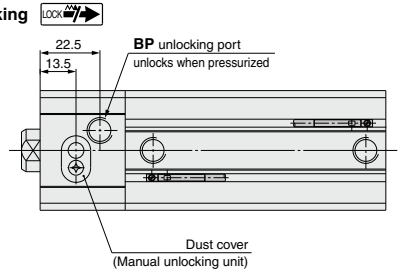

(mm)

Bore size (mm)	Stroke range	Without auto switch		With auto switch	
		A	B	A	B
32	10 to 50	62	23	72	33
	75, 100	72	33		

Port thread type	BP
Rc	1/8
NPT	
G	M5 x 0.8

\* Dimensions for cylinders with a rubber bumper are the same as the standard type above.

\*\* Refer to page 1024 for details of rod end nuts and accessory brackets.

#### Rod end male thread

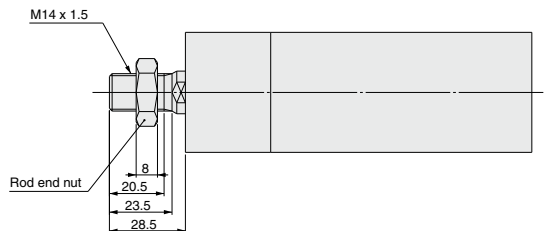

**Dimensions:  $\phi 32$**

**Foot type: C□LQL32**

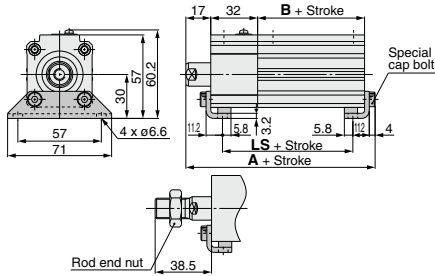

**Foot Type**

Bore size (mm)	Stroke range	Without auto switch			With auto switch		
		A	B	LS	A	B	LS
32	10 to 50	79.2	23	39	89.2	33	49
	75, 100	89.2	33	49			

Foot bracket material: Carbon steel  
Surface treatment: Nickel plated

**Rod side flange type: C□LQF32**

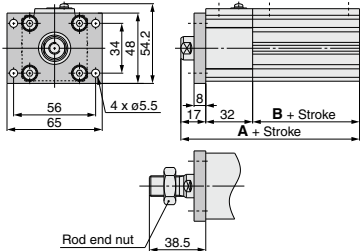

**Rod Side Flange Type**

Bore size (mm)	Stroke range	Without auto switch		With auto switch	
		A	B	A	B
32	10 to 50	72	23	82	33
	75, 100	82	33		

Flange bracket material: Carbon steel  
Surface treatment: Nickel plated

**Head Side flange type: C□LQG32**

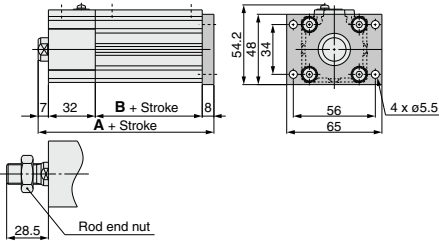

**Head Side Flange Type**

Bore size (mm)	Stroke range	Without auto switch		With auto switch	
		A	B	A	B
32	10 to 50	70	23	80	33
	75, 100	80	33		

Flange bracket material: Carbon steel  
Surface treatment: Nickel plated

**Double clevis type: C□LQD32**

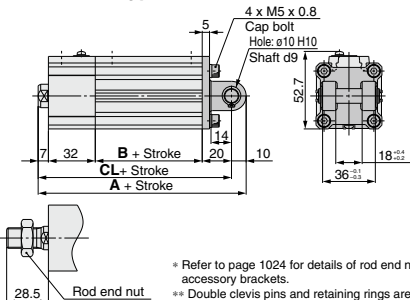

**Double Clevis Type**

Bore size (mm)	Stroke range	Without auto switch			With auto switch		
		A	B	CL	A	B	CL
32	10 to 50	92	23	82	102	33	92
	75, 100	102	33	92			

Double clevis bracket material: Cast iron  
Surface treatment: Painted

\* Refer to page 1024 for details of rod end nuts and accessory brackets.  
\*\* Double clevis pins and retaining rings are included.

- CLJ2
- CLM2
- CLG1
- CL1
- MLGC
- CNG
- MNB
- CNA2
- CNS
- CLS
- CLQ
- RLQ
- MLU
- MLGP
- ML1C

- D-□
- X□

# CLQ Series

Dimensions:  $\phi 40$

## Both ends tapped type: C□LQA40

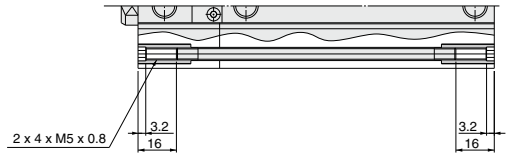

## Basic type (Through-hole): C□LQB40

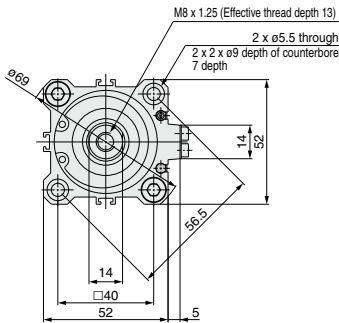

### Extension locking

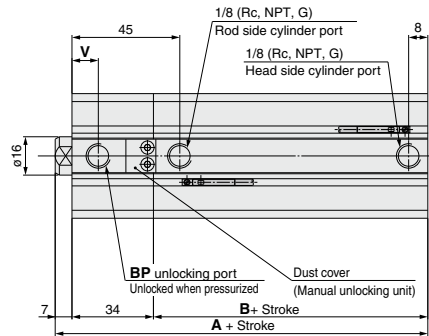

### Retraction locking

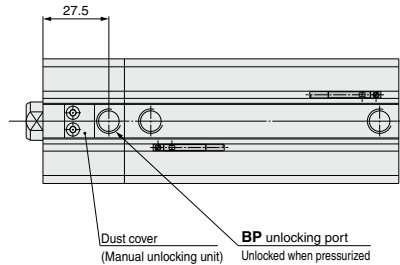

### A, B Dimensions

(mm)

Bore size (mm)	Stroke range (mm)	Without auto switch		With auto switch	
		A	B	A	B
40	10 to 50	70.5	29.5	80.5	39.5
	75, 100	80.5	39.5		

Port thread type	BP	V
Rc	1/8	11
NPT		
G	M5 x 0.8	13

\* Dimensions for cylinders with a rubber bumper are the same as the standard type above.

\*\* Refer to page 1024 for details of rod end nuts and accessory brackets.

### Rod end male thread

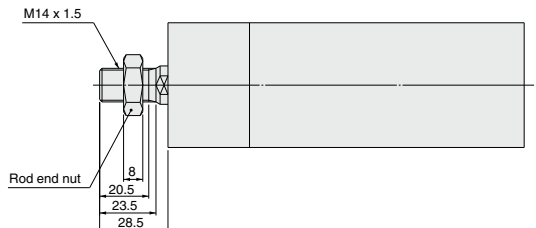

**Dimensions:  $\phi 40$**

**Foot type: C□LQL40**

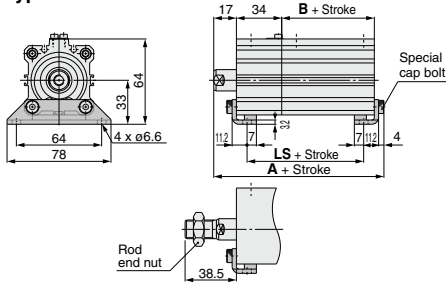

**Foot Type**

Bore size (mm)	Stroke range	Without auto switch			With auto switch		
		A	B	LS	A	B	LS
40	10 to 50	87.7	29.5	47.5	97.7	39.5	57.5
	75, 100	97.7	39.5	57.5			

Foot bracket material: Carbon steel  
Surface treatment: Nickel plated

**Rod side flange type: C□LQF40**

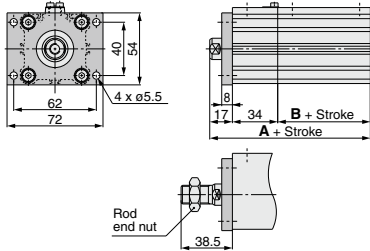

**Rod Side Flange Type**

Bore size (mm)	Stroke range	Without auto switch		With auto switch	
		A	B	A	B
40	10 to 50	80.5	29.5	90.5	39.5
	75, 100	90.5	39.5		

Flange bracket material: Carbon steel  
Surface treatment: Nickel plated

**Head Side flange type: C□LQG40**

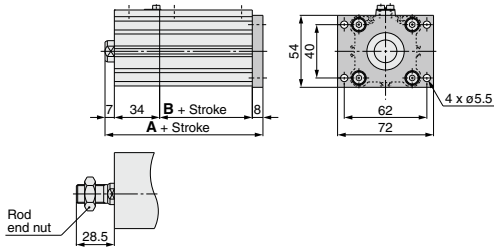

**Head Side Flange Type**

Bore size (mm)	Stroke range	Without auto switch		With auto switch	
		A	B	A	B
40	10 to 50	78.5	29.5	88.5	39.5
	75, 100	88.5	39.5		

Flange bracket material: Carbon steel  
Surface treatment: Nickel plated

**Double clevis type: C□LQD40**

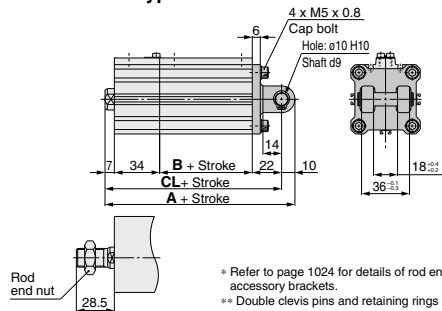

**Double Clevis Type**

Bore size (mm)	Stroke range	Without auto switch			With auto switch		
		A	B	CL	A	B	CL
40	10 to 50	102.5	29.5	92.5	112.5	39.5	102.5
	75, 100	112.5	39.5	102.5			

Double clevis bracket material: Cast iron  
Surface treatment: Painted

\* Refer to page 1024 for details of rod end nuts and accessory brackets.  
\*\* Double clevis pins and retaining rings are included.

CLJ2

CLM2

CLG1

CL1

MLGC

CNG

MNB

CNA2

CNS

CLS

CLQ

RLQ

MLU

MLGP

ML1C

D-□

-X□

# CLQ Series

Dimensions:  $\phi 50$

## Both ends tapped type: C□LQA50

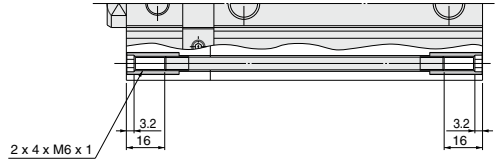

## Basic type (Through-hole): C□LQB50

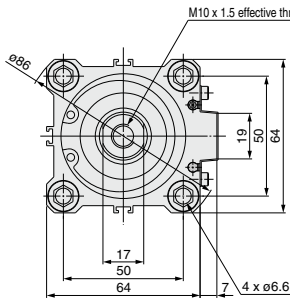

## Extension locking

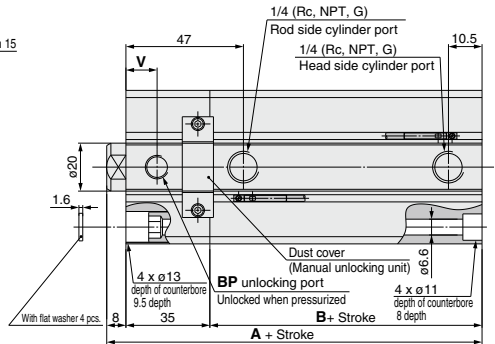

## Retraction locking

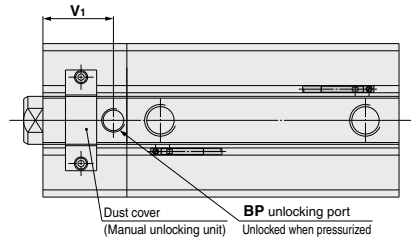

### A, B Dimensions

Bore size (mm)	Stroke range (mm)	Without auto switch		With auto switch	
		A	B	A	B
50	10 to 50	73.5	30.5	83.5	40.5
	75, 100	83.5	40.5		

Port thread type	BP	V	V <sub>1</sub>
Rc	1/8	13	28
NPT			
G	M5 x 0.8	15	30.2

\* Dimensions for cylinders with a rubber bumper are the same as the standard type above.

\*\* Refer to page 1024 for details of rod end nuts and accessory brackets.

## Rod end male thread

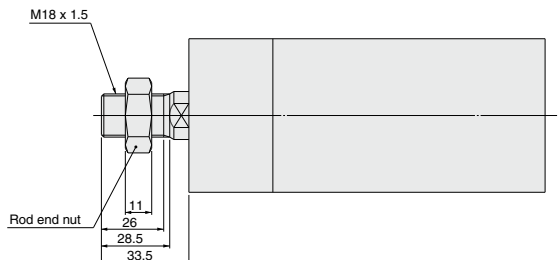

Note) Be sure to use the attached flat washers when mounting a cylinder from the rod side.



**Dimensions: ø50**

**Foot type: C□LQL50**

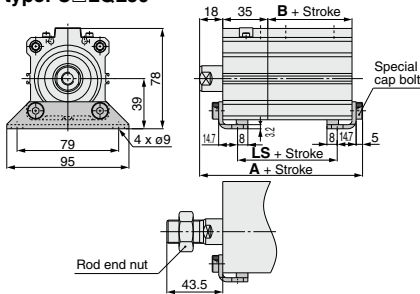

**Rod side flange type: C□LQF50**

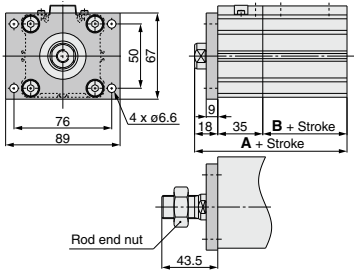

**Head Side flange type: C□LQG50**

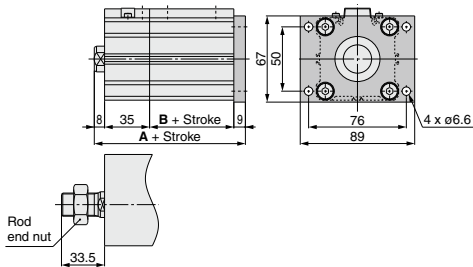

**Double clevis type: C□LQD50**

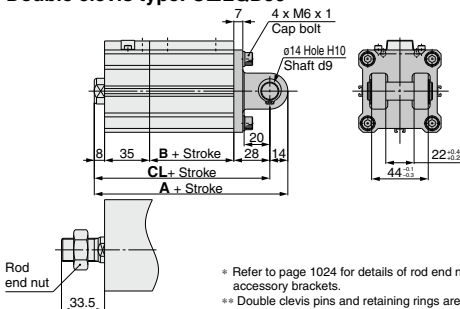

**Foot Type**

(mm)

Bore size (mm)	Stroke range	Without auto switch			With auto switch		
		A	B	LS	A	B	LS
50	10 to 50	91.7	30.5	42.5	101.7	40.5	52.5
	75, 100	101.7	40.5	52.5			

Foot bracket material: Carbon steel  
Surface treatment: Nickel plated

**Rod Side Flange Type**

(mm)

Bore size (mm)	Stroke range	Without auto switch		With auto switch	
		A	B	A	B
50	10 to 50	83.5	30.5	93.5	40.5
	75, 100	93.5	40.5		

Flange bracket material: Carbon steel  
Surface treatment: Nickel plated

**Head Side Flange Type**

(mm)

Bore size (mm)	Stroke range	Without auto switch		With auto switch	
		A	B	A	B
50	10 to 50	82.5	30.5	92.5	40.5
	75, 100	92.5	40.5		

Flange bracket material: Carbon steel  
Surface treatment: Nickel plated

**Double Clevis Type**

(mm)

Bore size (mm)	Stroke range	Without auto switch			With auto switch		
		A	B	CL	A	B	CL
50	10 to 50	115.5	30.5	101.5	125.5	40.5	111.5
	75, 100	125.5	40.5	111.5			

Double clevis bracket material: Cast iron  
Surface treatment: Painted

CLJ2

CLM2

CLG1

CL1

MLGC

CNG

MNB

CNA2

CNS

CLS

CLQ

RLQ

MLU

MLGP

ML1C

D-□

-X□

# CLQ Series

Dimensions:  $\varnothing 63$ ,  $\varnothing 80$ ,  $\varnothing 100$

## Both ends tapped type: C□LQA63/80/100

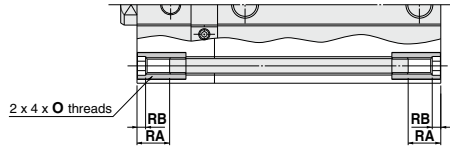

## Basic type (Through-hole): C□LQB63/80/100

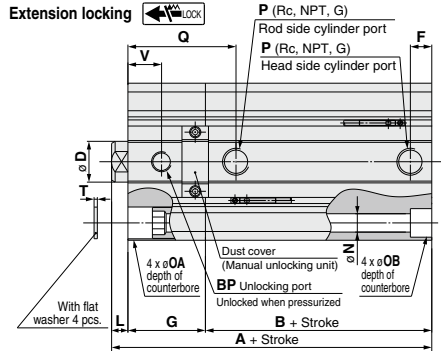
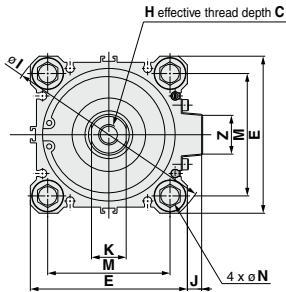

## Retraction locking

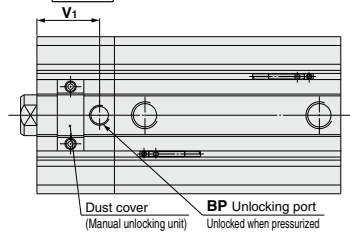

## Retraction Locking (mm)

Bore size (mm)	V1		
	Rc	NPT	G
63	30.5	33	
80	35.5	37.7	
100	40.5	41.5	

## Rod end male thread

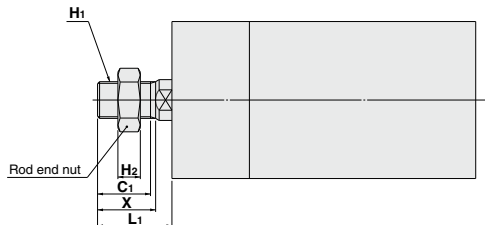

## Rod End Male Thread (mm)

Bore size (mm)	C1	X	H1	H2	L1
63	26	28.5	M18 x 1.5	11	33.5
80	32.5	35.5	M22 x 1.5	13	43.5
100	32.5	35.5	M26 x 1.5	16	43.5

\* Dimensions for cylinders with a rubber bumper are the same as the standard type above.

\*\* Refer to page 1024 for details of rod end nuts and accessory brackets.

Note) Be sure to use the attached flat washers when mounting a cylinder from the rod side. (mm)

Bore size (mm)	Stroke range (mm)	Without auto switch		With auto switch		BP		C	D	E	F	G	H	I	J	K	L	M	N	O	OA	OB	P	Q	RA	RB	T	V	Z
		A	B	A	B	Rc	NPT																						
63	10 to 50	82	36					15	20	77	10.5	38	M10 x 1.5	103	7	17	8	60	9	M8 x 1.25	15.6 depth 12	14 depth 10.5	1/4	53	16	4.2	1.6	16.5	19
	75, 100	92	46	92	46	1/8	M5 x 0.8																						
80	10 to 50	96.5	43.5					21	25	98	12.5	43	M16 x 2.0	132	6	22	10	77	11	M10 x 1.5	19.6 depth 15.5	17.5 depth 13.5	3/8	59	16	4.2	2	18.5	26
	75, 100	106.5	53.5	106.5	53.5	1/8	1/8																						
100	10 to 50	115	53					27	30	117	13	50	M20 x 2.5	156	6.5	27	12	94	11	M10 x 1.5	19.6 depth 15.5	17.5 depth 13.5	3/8	73	16	4.2	2	23	26
	75, 100	125	63	125	63	1/4	1/4																						

Dimensions:  $\phi 63$ ,  $\phi 80$ ,  $\phi 100$

Foot type: CLQL/CDLQL

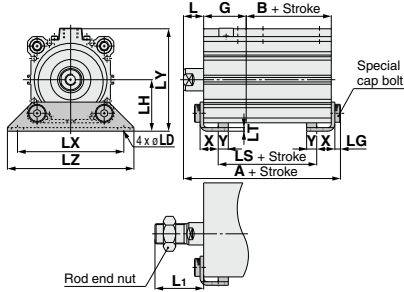

Rod side flange type: CLQF/CDLQF

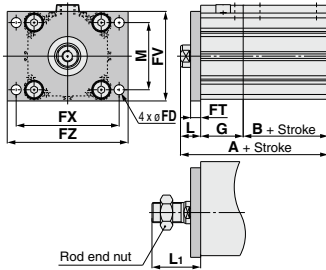

Head Side flange type: CLQG/CDLQG

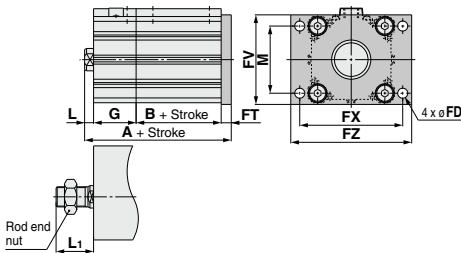

Double clevis type: CLQD/CDLQD

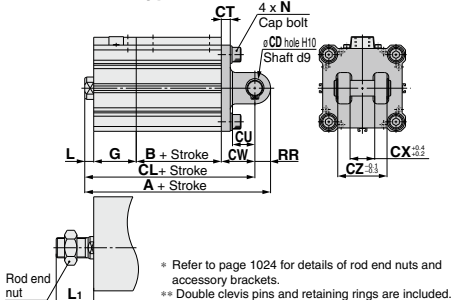

\* Refer to page 1024 for details of rod end nuts and accessory brackets.  
\*\* Double clevis pins and retaining rings are included.

Foot Type

Bore size (mm)	Stroke range	Without auto switch			With auto switch			G	L
		A	B	LS	A	B	LS		
63	10 to 50	100.2	36	48	110.2	46	58	38	18
	75, 100	110.2	46	58					
80	10 to 50	118	43.5	56.5	128	53.5	66.5	43	20
	75, 100	128	53.5	66.5					
100	10 to 50	138	53	69	148	63	79	50	22
	75, 100	148	63	79					

Bore size (mm)	L1	LD	LG	LH	LT	LX	LY	LZ	X	Y
63	43.5	11	5	46	3.2	95	91.5	113	16.2	9
80	53.5	13	7	59	4.5	118	114	140	19.5	11
100	53.5	13	7	71	6	137	136	162	23	12.5

Foot bracket material: Carbon steel  
Surface treatment: Nickel plated

Rod Side Flange Type

Bore size (mm)	Stroke range	Without auto switch		With auto switch		FD	FT
		A	B	A	B		
63	10 to 50	92	36			9	9
	75, 100	102	46	102	46		
80	10 to 50	106.5	43.5			11	11
	75, 100	116.5	53.5	116.5	53.5		
100	10 to 50	125	53			11	11
	75, 100	135	63	135	63		

Bore size (mm)	FV	FX	FZ	G	L	L1	M
63	80	92	108	38	18	43.5	60
80	99	116	134	43	20	53.5	77
100	117	136	154	50	22	53.5	94

Flange bracket material: Carbon steel  
Surface treatment: Nickel plated

Head Side Flange Type

Bore size (mm)	Stroke range	Without auto switch		With auto switch		FD	FT
		A	B	A	B		
63	10 to 50	91	36			9	9
	75, 100	101	46	101	46		
80	10 to 50	107.5	43.5			11	11
	75, 100	117.5	53.5	117.5	53.5		
100	10 to 50	126	53			11	11
	75, 100	136	63	136	63		

Bore size (mm)	FV	FX	FZ	G	L	L1	M
63	80	92	108	38	8	33.5	60
80	99	116	134	43	10	43.5	77
100	117	136	154	50	12	43.5	94

Flange bracket material: Carbon steel  
Surface treatment: Nickel plated

Double Clevis Type

Bore size (mm)	Stroke range	Without auto switch			With auto switch			CD	CT
		A	B	CL	A	B	CL		
63	10 to 50	126	36	112			14	8	
	75, 100	136	46	122	136	46			122
80	10 to 50	152.5	43.5	134.5			18	10	
	75, 100	162.5	53.5	144.5	162.5	53.5			144.5
100	10 to 50	182	53	160			22	13	
	75, 100	192	63	170	192	63			170

Bore size (mm)	CU	CW	CX	CZ	G	L	L1	N	RR
63	20	30	22	44	38	8	33.5	M8 x 1.25	14
80	27	38	28	56	43	10	43.5	M10 x 1.5	18
100	31	45	32	64	50	12	43.5	M10 x 1.5	22

Double clevis bracket material: Cast iron  
Surface treatment: Painted

CLJ2

CLM2

CLG1

CL1

MLGC

CNG

MNB

CNA2

CNS

CLS

CLQ

RLQ

MLU

MLGP

ML1C

D-□

X-□

# CLQ Series Accessory Bracket Dimensions

## Single Knuckle Joint

I-G02, I-G03

I-G04, I-G05  
I-G08, I-G10

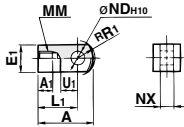

Material: Rolled steel  
Surface treatment: Nickel plated

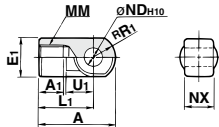

Material: Cast iron  
Surface treatment: Nickel plated

## Double Knuckle Joint

Y-G02, Y-G03

Y-G04, Y-G05  
Y-G08, Y-G10

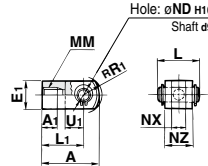

Material: Rolled steel  
Surface treatment: Nickel plated

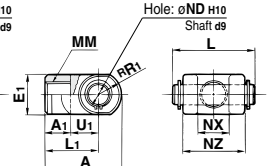

Material: Cast iron  
Surface treatment: Nickel plated

(mm)

Part no.	Applicable bore size (mm)	A	A <sub>1</sub>	E <sub>1</sub>	L <sub>1</sub>	MM	RR <sub>1</sub>	U <sub>1</sub>	ND	NX
I-G02	20	34	8.5	□16	25	M8 x 1.25	10.3	11.5	8 <sup>+0.058</sup> <sub>0</sub>	8 <sup>-0.2</sup> <sub>-0.4</sub>
I-G03	25	41	10.5	□20	30	M10 x 1.25	12.8	14	10 <sup>+0.058</sup> <sub>0</sub>	10 <sup>-0.2</sup> <sub>-0.4</sub>
I-G04	32, 40	42	14	∅22	30	M14 x 1.5	12	14	10 <sup>+0.058</sup> <sub>0</sub>	18 <sup>-0.3</sup> <sub>-0.5</sub>
I-G05	50, 63	56	18	∅28	40	M18 x 1.5	16	20	14 <sup>+0.070</sup> <sub>0</sub>	22 <sup>-0.3</sup> <sub>-0.5</sub>
I-G08	80	71	21	∅38	50	M22 x 1.5	21	27	18 <sup>+0.070</sup> <sub>0</sub>	28 <sup>-0.3</sup> <sub>-0.5</sub>
I-G10	100	79	21	∅44	55	M26 x 1.5	24	31	22 <sup>+0.084</sup> <sub>0</sub>	32 <sup>-0.3</sup> <sub>-0.5</sub>

(mm)

Part no.	Applicable bore size (mm)	A	A <sub>1</sub>	E <sub>1</sub>	L <sub>1</sub>	MM	RR <sub>1</sub>	U <sub>1</sub>	ND
Y-G02	20	34	8.5	□16	25	M8 x 1.25	10.3	11.5	8 <sup>+0.058</sup> <sub>0</sub>
Y-G03	25	41	10.5	□20	30	M10 x 1.25	12.8	14	10 <sup>+0.058</sup> <sub>0</sub>
Y-G04	32, 40	42	16	∅22	30	M14 x 1.5	12	14	10 <sup>+0.058</sup> <sub>0</sub>
Y-G05	50, 63	56	20	∅28	40	M18 x 1.5	16	20	14 <sup>+0.070</sup> <sub>0</sub>
Y-G08	80	71	23	∅38	50	M22 x 1.5	21	27	18 <sup>+0.070</sup> <sub>0</sub>
Y-G10	100	79	24	∅44	55	M26 x 1.5	24	31	22 <sup>+0.084</sup> <sub>0</sub>

Part no.	Applicable bore size (mm)	NX	NZ	L	Applicable pin part no.
Y-G02	20	8 <sup>+0.4</sup> <sub>+0.2</sub>	16	21	IY-G02
Y-G03	25	10 <sup>+0.4</sup> <sub>+0.2</sub>	20	25.6	IY-G03
Y-G04	32, 40	18 <sup>+0.5</sup> <sub>+0.3</sub>	36	41.6	IY-G04
Y-G05	50, 63	22 <sup>+0.5</sup> <sub>+0.3</sub>	44	50.6	IY-G05
Y-G08	80	28 <sup>+0.5</sup> <sub>+0.3</sub>	56	64	IY-G08
Y-G10	100	32 <sup>+0.5</sup> <sub>+0.3</sub>	64	72	IY-G10

\* Knuckle pins and retaining rings are included.

## Knuckle Pin (Common with double clevis pin)

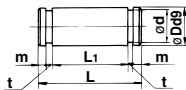

Material: Carbon steel  
(mm)

Part no.	Applicable bore size (mm)	D	L	d	L <sub>1</sub>	m	t	Applicable retaining ring
IY-G02	20	8 <sup>-0.040</sup> <sub>-0.076</sub>	21	7.6	16.2	1.5	0.9	Type C 8 for axis
IY-G03	25	10 <sup>-0.040</sup> <sub>-0.076</sub>	25.6	9.6	20.2	1.55	1.15	Type C 10 for axis
IY-G04	32, 40	10 <sup>-0.040</sup> <sub>-0.076</sub>	41.6	9.6	36.2	1.55	1.15	Type C 10 for axis
IY-G05	50, 63	14 <sup>-0.050</sup> <sub>-0.093</sub>	50.6	13.4	44.2	2.05	1.15	Type C 14 for axis
IY-G08	80	18 <sup>-0.050</sup> <sub>-0.093</sub>	64	17	56.2	2.55	1.35	Type C 18 for axis
IY-G10	100	22 <sup>-0.065</sup> <sub>-0.117</sub>	72	21	64.2	2.55	1.35	Type C 22 for axis

\* Retaining rings are included.

1024

## Rod End Nut

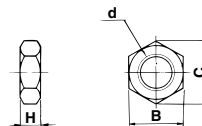

Material: Rolled steel  
(mm)

Part no.	Applicable bore size (mm)	d	H	B	C
NT-02	20	M8 x 1.25	5	13	15.0
NT-03	25	M10 x 1.25	6	17	19.6
NT-04	32, 40	M14 x 1.5	8	22	25.4
NT-05	50, 63	M18 x 1.5	11	27	31.2
NT-08	80	M22 x 1.5	13	32	37.0
NT-10	100	M26 x 1.5	16	41	47.3

**Simple Joint:  $\phi 32$  to  $\phi 100$**

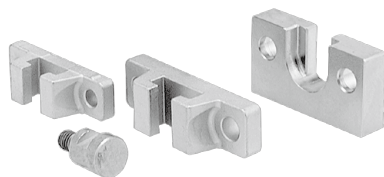

**Joint and Mounting Bracket (Type A, Type B) Part No.**

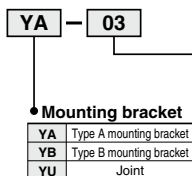

• Applicable air cylinder bore

03	$\phi 32, \phi 40$
05	$\phi 50, \phi 63$
08	$\phi 80$
10	$\phi 100$

• Mounting bracket

YA	Type A mounting bracket
YB	Type B mounting bracket
YU	Joint

Bore size (mm)	Joint	Applicable mounting bracket	
		Type A mounting bracket	Type B mounting bracket
32, 40	YU-03	YA-03	YB-03
50, 63	YU-05	YA-05	YB-05
80	YU-08	YA-08	YB-08
100	YU-10	YA-10	YB-10

**Allowable Eccentricity**

Bore size (mm)	32	40	50	63	80	100
Eccentricity tolerance	$\pm 1$				$\pm 1.5$	$\pm 2$
Backlash	0.5					

<Ordering>

- Joints are not included with the A or B type mounting brackets. Order them separately.

(Example)

- Bore size  $\phi 40$  Part no.
- Type A mounting bracket part number.....YA-03
- Joint.....YU-03

**Joint**

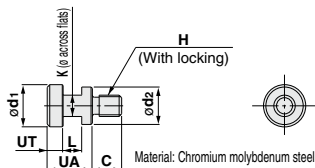

Material: Chromium molybdenum steel (Nickel plated)

Part no.	Applicable bore size (mm)	UA	C	d1	d2	H	K	L	UT	Weight (g)
YU-03	32, 40	17	11	15.8	14	M8 x 1.25	8	7	6	25
YU-05	50, 63	17	13	19.8	18	M10 x 1.5	10	7	6	40
YU-08	80	22	20	24.8	23	M16 x 2	13	9	8	90
YU-10	100	26	26	29.8	28	M20 x 2.5	14	11	10	160

**Type A Mounting Bracket**

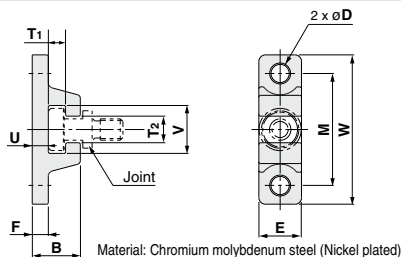

Material: Chromium molybdenum steel (Nickel plated) (mm)

Part no.	Bore size (mm)	B	D	E	F	M	T <sub>1</sub>	T <sub>2</sub>
YA-03	32, 40	18	6.8	16	6	42	6.5	10
YA-05	50, 63	20	9	20	8	50	6.5	12
YA-08	80	26	11	25	10	62	8.5	16
YA-10	100	31	14	30	12	76	10.5	18

Part no.	Bore size (mm)	U	V	W	Weight (g)
YA-03	32, 40	6	18	56	55
YA-05	50, 63	8	22	67	100
YA-08	80	10	28	83	195
YA-10	100	12	36	100	340

**Type B Mounting Bracket**

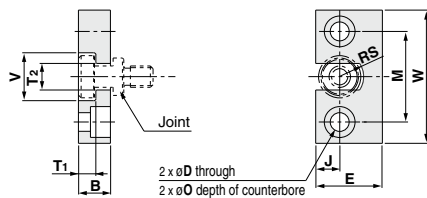

Material: Stainless steel (mm)

Part no.	Bore size (mm)	B	D	E	J	M	O
YB-03	32, 40	12	7	25	9	34	11.5 depth 7.5
YB-05	50, 63	12	9	32	11	42	14.5 depth 8.5
YB-08	80	16	11	38	13	52	18 depth 12
YB-10	100	19	14	50	17	62	21 depth 14

Part no.	Bore size (mm)	RS	T <sub>1</sub>	T <sub>2</sub>	V	W	Weight (g)
YB-03	32, 40	9	6.5	10	18	50	80
YB-05	50, 63	11	6.5	12	22	60	120
YB-08	80	14	8.5	16	28	75	230
YB-10	100	18	10.5	18	36	90	455

- CLJ2
- CLM2
- CLG1
- CL1
- MLGC
- CNG
- MNB
- CNA2
- CNS
- CLS
- CLQ
- RLQ
- MLU
- MLGP
- ML1C

- D-□
- X□

# Auto Switch Mounting 1

## Minimum Auto Switch Mounting Stroke

No. of auto switches mounted	D-M9□V D-F7□V D-J79C	D-A9□V D-A7□ D-A80 D-A73C D-A80C	D-A9□ D-M9□	D-M9□WV D-M9□AV D-F7□WV D-F7BAV	D-M9□W D-M9□A D-A7□H D-A80H D-F7□ D-J79	D-A79W	D-F7□W D-J79W D-F7BA D-F79F	D-P3DWA	D-P4DW
	1 pc.	5	5	10	10	15	15	20	15
2 pcs.	5	10	10	15	15	20	20	15	15

(mm)

## Auto Switch Proper Mounting Position (Detection at Stroke End) and Its Mounting Height

ø20, ø25

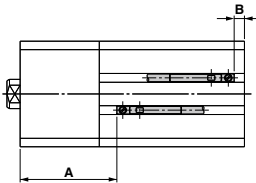

D-M9□  
D-M9□W  
D-M9□A  
D-A9□

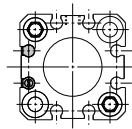

D-M9□V  
D-M9□WV  
D-M9□AV  
D-A9□V

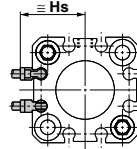

ø32 to ø100

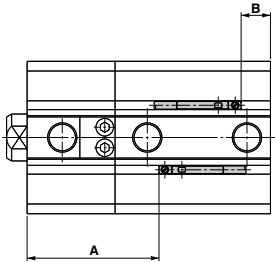

D-M9□  
D-M9□W  
D-M9□A  
D-A9□

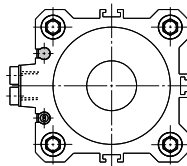

D-M9□V  
D-M9□WV  
D-M9□AV  
D-A9□V

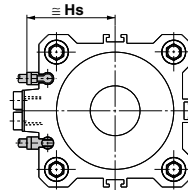

### Auto Switch Proper Mounting Position (mm)

Auto switch model	D-M9□ D-M9□V D-M9□W D-M9□WV D-M9□A D-M9□AV		D-A9□ D-A9□V	
	A	B	A	B
	Bore size (mm)			
20	37	7.5	33	3.5
25	42	9.5	38	5.5
32	44	9	40	5
40	50	11.5	46	7.5
50	49	14.5	45	10.5
63	54.5	17.5	50.5	13.5
80	63.5	21	59.5	17
100	74	27	70	23

### Auto Switch Mounting Height (mm)

Auto switch model	D-M9□V D-M9□WV D-M9□AV		D-A9□V
	Hs		Hs
Bore size (mm)			
20	25		22.5
25	27		24.5
32	29		27
40	32.5		30.5
50	38.5		36.5
63	42		40
80	52		50
100	62		60

Note) Adjust the auto switch after confirming the operating conditions in the actual setting.

**Auto Switch Proper Mounting Position (Detection at Stroke End) and Its Mounting Height**

- D-A7□
- D-A80
- D-A7□H
- D-A80H
- D-F7□
- D-J79
- D-F7□W
- D-J79W
- D-F79F
- D-F7NT
- D-F7BA
- D-A73C
- D-A80C
- D-J79C
- D-A79W
- D-F7□WV
- D-F7□V
- D-F7BAV

ø32 to ø100

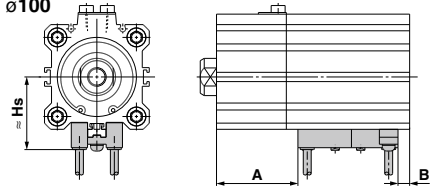

**D-P3DWA**

ø25

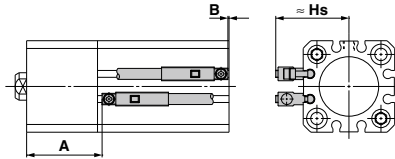

ø32 to ø100

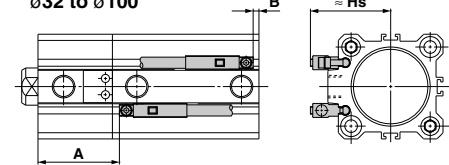

**D-P4DW**

ø40 to ø100

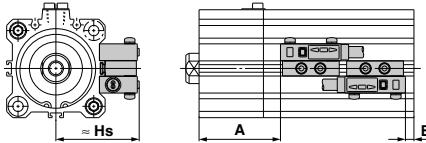

**Auto Switch Proper Mounting Position**

(mm)

Auto switch model Bore size (mm)	D-A73 D-A80		D-A72/A7□H D-A80H/A73C D-A80C/F7BAV D-F7BA/F79F D-F7□W/F7□ D-J79/F7□V D-J79C/J79W D-F7□WV		D-F7NT		D-A79W		D-P3DWA		D-P4DW	
	A	B	A	B	A	B	A	B	A	B	A	B
20	—	—	—	—	—	—	—	—	—	—	—	—
25	—	—	—	—	—	—	—	—	37.5	5	—	—
32	41	6	41.5	6.5	46.5	11.5	38.5	3.5	39.5	4.5	—	—
40	47	8.5	47.5	9	52.5	14	44.5	6	45.5	7	43	4.5
50	46	11.5	46.5	12	51.5	17	43.5	9	44.5	10	42	7.5
63	51.5	14.5	52	15	57	20	49	12	50	13	47.5	10.5
80	60.5	18	61	18.5	66	23.5	58	15.5	59	16.5	56.5	14
100	71	24	71.5	24.5	76.5	29.5	68.5	21.5	69.5	22.5	67	20

Note 1) Adjust the auto switch after confirming the operating conditions in the actual setting.  
 Note 2) For bore sizes ø32 to ø50, the D-P3DWA is mountable only on the port side.

**Auto Switch Mounting Height**

(mm)

Auto switch model Bore size (mm)	D-A7□ D-A80	D-A7□H D-A80H D-F7□ D-J79 D-F7□W D-J79W D-F7BA D-F79F D-F7NT	D-A73C D-A80C	D-F7□V D-F7□WV D-F7BAV	D-J79C	D-A79W	D-P3DWA	D-P4DW
	Hs	Hs	Hs	Hs	Hs	Hs	Hs	
20	—	—	—	—	—	—	—	
25	—	—	—	—	—	33	—	
32	31.5	32.5	38.5	35	38	34	35.5	
40	35	36	42	38.5	41.5	37.5	39	
50	41	42	48	44.5	47.5	43.5	45	
63	47.5	48.5	54.5	51	54	50	48.5	
80	57.5	58.5	64.5	61	64	60	58.5	
100	67.5	68.5	74.5	71	74	70	68.5	

- CLJ2
- CLM2
- CLG1
- CL1
- MLGC
- CNG
- MNB
- CNA2
- CNS
- CLS
- CLQ
- RLQ
- MLU
- MLGP
- ML1C

- D-□
- X□

# CLQ Series Auto Switch Mounting 2

## Operating Range

Auto switch model	Bore size (mm)							
	20	25	32	40	50	63	80	100
D-M9□/M9□V D-M9□W/M9□WV D-M9□A/M9□AV	4.5	4.5	5	5	6	6.5	6.5	7.5
D-A9□/A9□V	10	10	9.5	9.5	9.5	11.5	9	11.5
D-A7□/F7□H D-A73C D-A80/A80H D-A80C	—	—	12	11	10	12	12	13
D-A79W	—	—	13	14	14	16	15	17
D-F7□/F7□V D-J79/J79C D-F7□W/F7□WV D-J79W D-F7BA/F7BAV D-F7NT/F79F	—	—	6	6	6	6.5	6.5	7
D-P3DWA	—	5	6	6	7.5	6.5	6.5	7.5
D-P4DW	—	—	—	5	5	5	5	5.5

\* Since this is a guideline including hysteresis, not meant to be guaranteed. (Assuming approximately ±30% dispersion)

There may be the case it will vary substantially depending on an ambient environment.

\* Auto switch mounting brackets BQ2-012 are not used for sizes over ø32 of D-A9□(V)/M9□(V)/M9□W(V)/M9□A(V) types.

The above values indicate the operating range when mounted with the conventional auto switch installation groove.

## Auto Switch Mounting Bracket: Part No.

Auto switch mounting surface	Bore size (mm)		
	ø20	ø25	ø32, ø40, ø50
Auto switch model	Auto switch mounting surface Port, A, B, C sides	Auto switch mounting surface Port side	Auto switch mounting surface A, B, C sides
D-M9□ D-M9□V D-M9□W D-M9□WV D-M9□A D-M9□AV D-A9□ D-A9□V	Auto switch mounting bracket not required.	Auto switch mounting bracket not required.	Auto switch mounting bracket not required.
D-P3DWA	—	Auto switch mounting bracket not required.	—

Note 1) For each cylinder series, when a compact auto switch is mounted on the three sides (A, B and C above) other than the port side of bore sizes ø32 to ø50, the auto switch mounting brackets above are required. Order them separately from cylinders.

(It is the same as when mounting compact cylinders with an auto switch mounting rail, but not with ø63 to ø100 compact auto switch installation groove.)

Example order

CDLOB32-50-M9BW 1 unit

BQ-2 2 pcs.

BQ2-012 2 pcs.

Note 2) Auto switch mounting brackets and auto switches are shipped together with cylinders.



**Auto Switch Mounting Bracket: Part. No.**

Auto switch model	Bore size (mm)					
	25	32	40	50	63	80
D-A7□/A80 D-A73C/A80C D-A7□H/A80H D-A79W D-F7□/J79 D-F7□V D-J79C D-F7□W/J79W D-F7□WV D-F7BA/F7BAV D-F79F/F7NT	—		BQ-2			
D-P4DW	—		BQP1-050			

Note 1) Auto switch mounting brackets and auto switches are shipped together with cylinders.

**[Mounting screw set made of stainless steel]**

The following set of mounting screws made of stainless steel (including nuts) is available. Use it in accordance with the operating environment. (Please order BQ-2 separately, since the auto switch spacer (for BQ-2) is not included.)

BBA2: For D-A7/A8/F7/J7 types

Water resistant auto switches, D-F7BA/F7BAV are set on the cylinder with the stainless steel screws above when shipped. When an auto switch is shipped independently, BBA2 is attached.

Note 1) Refer to page 1229 for the details of BBA2.

Note 2) When mounting D-M9□E(V) on a port other than the ports for ø32, ø40 and ø50, order auto switch mounting brackets BQ2-012S, BQ-2 and stainless steel screw set BBA2 separately.

**Auto Switch Mounting Bracket Weight**

Auto switch mounting bracket part no.	Weight (g)
BQ-2	1.5
BQ2-012	5
BQP1-050	16

CLJ2

CLM2

CLG1

CL1

MLGC

CNG

MNB

CNA2

CNS

CLS

**CLQ**

RLQ

MLU

MLGP

ML1C

Other than the applicable auto switches listed in “How to Order”, the following auto switches can be mounted. For details, refer to pages 1119 to 1245.

Auto switch type	Model	Electrical entry (Fetching direction)	Features
<b>Reed</b>	D-A73	Grommet (Perpendicular)	—
	D-A80		Without indicator light
	D-A73H, A76H	Grommet (In-line)	—
	D-A80H		Without indicator light
<b>Solid state</b>	D-F7NV, F7PV, F7BV	Grommet (Perpendicular)	—
	D-F7NWW, F7BWW		Diagnostic indication(2-color indicator)
	D-F7BAV		Water resistant (2-color indicator)
	D-F79, F7P, J79		—
	D-F79W, F7PW, J79W	Grommet (In-line)	Diagnostic indication(2-color indicator)
	D-F7BA		Water resistant (2-color indicator)
	D-F7NT		With timer
	D-P5DW		Magnetic field resistant (2-color indicator)

\* For solid state auto switches, auto switches with a pre-wired connector are also available. Refer to pages 1192 and 1193 for details.

\* Normally closed (NC = b contact) solid state auto switches (D-M9□E(V)) are also available. Refer to page 1592-1 for details.

\* D-A7/A8/F7/J7 types cannot be mounted on ø20 and ø25.

D-□

-X□



# CLQ Series

## Specific Product Precautions 1

Be sure to read this before handling the products.

Refer to back page 50 for Safety Instructions and pages 3 to 12 for Actuator and Auto Switch Precautions.

### Selection

#### Warning

1. The holding force (max. static load) indicates the maximum capability to hold a static load without vibration and impact. The maximum load in a locked state should be below 50 % of the holding force (max. static load).

Refer to 6 when the kinetic energy of the workpiece is absorbed at the cylinder end or eccentric loads are applied.

2. Do not use for intermediate stops while the cylinder is operating.

This cylinder is designed for locking against inadvertent movement with the locking mechanism from a stationary condition. Do not perform intermediate stops while the cylinder is operating, as this may damage the cylinder, cause unlocking malfunction or shorten the service life.

3. Select the correct locking direction, as this cylinder does not generate holding force opposite to the locking direction.

The extension locking does not generate holding force in the cylinder's retracting direction, and the retraction lock does not generate holding force in the cylinder's extension direction.

4. Even when locked, there may be a stroke movement of approximately 1 mm in the locking direction due to external forces, such as the workpiece mass.

Even when locked, if air pressure drops, a stroke movement of approximately 1 mm may be generated in the locking direction of the lock mechanism due to external forces such as the workpiece mass.

5. When in the locked state, do not apply a load accompanied by an impact shock, strong vibration or turning force, etc.

This may damage the locking mechanism, shorten the service life or cause unlocking malfunction.

6. Operate so that load mass, maximum speed and eccentric distance are within the limiting ranges in the graphs below.

If the products are used beyond the limiting range, it may lead to a reduced service life or cause damage to the machinery.

#### Allowable Kinetic Energy (Energy absorbable at the cylinder end)

Extension Locking, Without Cushion

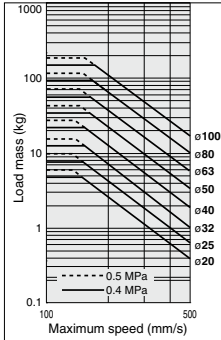

Retraction Locking, Without Cushion

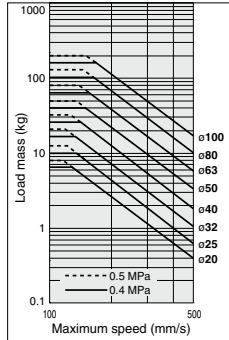

Extension Locking, Rubber Bumper

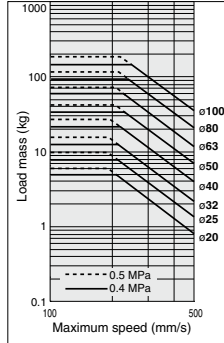

Retraction Locking, Rubber Bumper

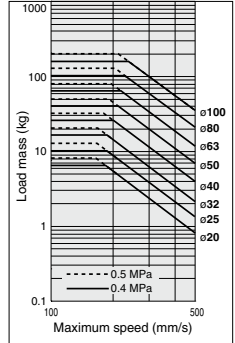

#### Allowable Load Mass

Horizontal (Without auto switch)

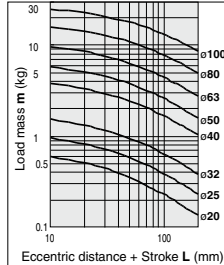

Horizontal (With auto switch)

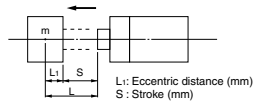
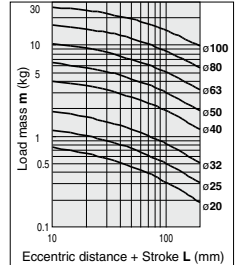



# CLQ Series

## Specific Product Precautions 2

Be sure to read this before handling the products.

Refer to back page 50 for Safety Instructions and pages 3 to 12 for Actuator and Auto Switch Precautions.

### Pneumatic Circuit

#### Warning

##### • Drop prevention circuit

**1. Do not use 3 position valves with circuit example 1.**  
The lock may be released due to inflow of the unlocking pressure.

**2. Install speed controllers as meter-out control. (Circuit example 1)**  
When they are not installed or they are used under meter-in control, it may cause malfunction.

**3. Branch off the compressed air piping for the lock unit between the cylinder and the speed controller. (Circuit example 1)**  
Note that branching off in other sections may shorten the service life.

**4. Perform piping so that the unlocking port side going from the piping junction is short. (Circuit example 1)**  
If the piping of unlocking port side is longer than that of the cylinder port from the piping junction, this may cause unlocking malfunction or shorten the service life.

**5. Be aware of reverse exhaust pressure flow from common exhaust type valve manifolds. (Circuit example 1)**  
Since the lock may be released due to reverse exhaust pressure flow, use an individual exhaust type manifold or single type valve.

**6. Be sure to release the lock before operating the cylinder. (Circuit example 2)**  
When the lock release delays, a cylinder may eject at high speed, which is extremely dangerous. It may also damage the cylinder, greatly shorten the service life or cause locking malfunction. Even when the cylinder moves freely, be sure to release the lock and operate the cylinder.

**7. Be aware that the locking action may be delayed due to the piping length or the timing of exhaust. (Circuit example 2)**  
The locking action may be delayed due to the piping length or the timing of exhaust, which also makes the stroke movement toward the lock larger. Install the solenoid valve for locking closer to the cylinder than the cylinder drive solenoid valve.

##### • Emergency stop circuit

**1. Perform emergency stops with the pneumatic circuit. (Circuit examples 3 and 4)**  
This cylinder is designed for locking against inadvertent movement from a stationary condition. Do not perform intermediate stops while the cylinder is operating, as this may damage the cylinder, cause unlocking malfunction or shorten the service life. Emergency stops must be performed with the pneumatic circuit, and workpieces must be held with the locking mechanism after the cylinder fully stops.

**2. When restarting the cylinder from the locked state, remove the workpiece and exhaust the residual pressure in the cylinder. (Circuit examples 3 and 4)**  
A cylinder may eject at high speed, which is extremely dangerous. It may also damage the cylinder, greatly shorten the service life or cause locking malfunction.

**3. Be sure to release the lock before operating the cylinder. (Circuit example 4)**  
When the lock release delays, the cylinder may eject at high speed, which is extremely dangerous. It may also damage the cylinder, greatly shorten the service life or cause locking malfunction. Even when the cylinder moves freely, be sure to release the lock and operate the cylinder.

##### • Drop prevention circuit, Emergency stop circuit

**1. If installing a solenoid valve for a lock unit, be aware that repeated supply and exhaustion of air may cause condensation. (Circuit examples 2 and 4)**  
The lock unit operating stroke is very small and so the pipe is long. If supplying and exhausting air repeatedly, condensation, which occurs by adiabatic expansion, accumulates in the lock unit. This may then cause air leakage and an unlocking malfunction due to corrosion of internal parts.

##### Circuit example

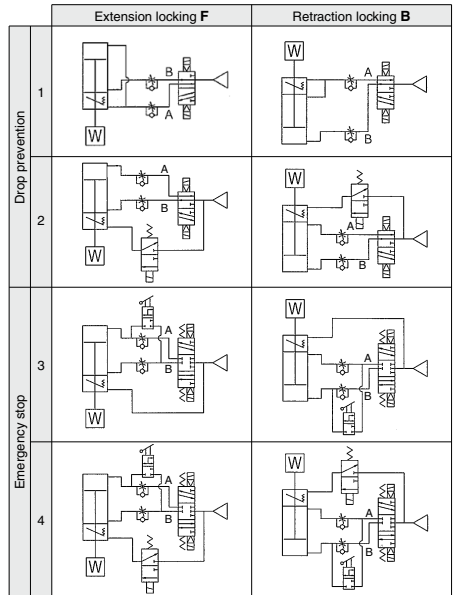

\* The symbol for the cylinder with lock in the basic circuit uses SMC original symbol.

### Mounting

#### Caution

**1. Be sure to connect the load to the rod end with the cylinder in an unlocked condition.**

If this is done in the locked state, it may cause damage to the lock mechanism.

**2. Mount auto switches from the head side.**

The lock body and cylinder tube exterior have the same shape for cylinder bore sizes  $\phi 40$  to  $\phi 100$ , but auto switches may not be mountable from the rod side. For the head side flange or double clevis type, install mounting brackets after mounting auto switches and auto switch mounting brackets from the head side.

CLJ2

CLM2

CLG1

CL1

MLGC

CNG

MNB

CNA2

CNS

CLS

CLQ

RLQ

MLU

MLGP

ML1C

D-□

-X□



# CLQ Series

## Specific Product Precautions 3

Be sure to read this before handling the products.

Refer to back page 50 for Safety Instructions and pages 3 to 12 for Actuator and Auto Switch Precautions.

### Preparing for Operation

#### Warning

- When starting operation from the locked position, be sure to restore air pressure to the B line in the pneumatic circuit.

When pressure is not applied to the B line, the load may drop or the cylinder may eject at high speed, which is extremely dangerous. It may also damage the cylinder, greatly shorten the service life or cause unlocking malfunction. When applying pressure to the B line, be sure to confirm whether the environment is safe, since workpieces may move.

- Size  $\phi 20$  to  $\phi 32$  are shipped in the unlocked condition maintained by the unlocking bolt. Be sure to remove the unlocking bolt following the steps below before operation.

The unlocking mechanism will not be effective without the removal of the unlocking bolt.

Only  $\phi 20$  to  $\phi 32$

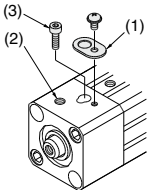

- Confirm that there is no air pressure inside the cylinder, and remove the dust cover (1).
- Supply air pressure of 0.2 MPa or more to unlocking port (2) shown in the drawing on the left.
- Remove the unlocking bolt (3) with a hexagon wrench (width across flats 2.5).

Since a holding function for the unlocked state is not available for sizes  $\phi 40$  through  $\phi 100$ , they can be used as shipped.

### Manually Unlocking

#### Warning

- Do not perform unlocking while an external force such as a load or spring force is being applied.

This is very dangerous because the cylinder will move suddenly.

Release the lock after preventing cylinder movement with a lifting device such as a jack.

- After confirming safety, operate the manual release following the steps shown below.

Confirm that there are no personnel inside the load movement range, etc., and that there is no danger even if the load moves suddenly.

#### Manually unlocking

$\phi 20$  to  $\phi 32$

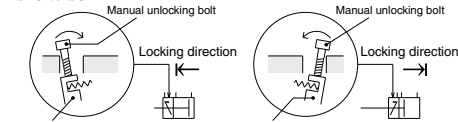

#### Extension locking

- Remove the dust cover.
- Screw a manual unlocking bolt (a bolt of M3 x 0.5 x 15 L or more commercially available) into the lock ring threads as shown above, and lightly push the bolt in the direction of the arrow (head side) to unlock.

#### Retraction locking

- Remove the dust cover.
- Screw a manual unlocking bolt (a bolt of M3 x 0.5 x 15 L or more commercially available) into the lock ring threads as shown above, and lightly push the bolt in the direction of the arrow (rod side) to unlock.

### Manually Unlocking

#### Warning

$\phi 40$  to  $\phi 100$

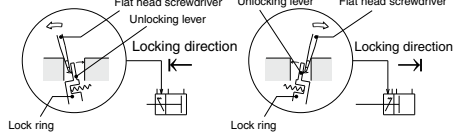

#### Extension locking

- Remove the dust cover.
- Insert a flat head screwdriver on the rod side of the manual unlocking lever as shown in the figure above, and lightly push the screwdriver in the direction of the arrow (rod side) to unlock.

#### Retraction locking

- Remove the dust cover.
- Insert a flat head screwdriver on the head side of the manual unlocking lever as shown in the figure above, and lightly push the screwdriver in the direction of the arrow (head side) to unlock.

### Maintenance

#### Caution

- In order to maintain good performance, operate with clean unlubricated air.

If lubricated air, compressor oil or drainage, etc., enters the cylinder, there is a danger of sharply reducing the locking performance.

- Do not apply grease to the piston rod.

There is a danger of sharply reducing the locking performance.

- Never disassemble the lock unit.

It contains a heavy duty spring which is dangerous and there is also a danger of reducing the locking performance.

- Never remove the pivot seal and disassemble the internal unit.

As for  $\phi 20$  to  $\phi 32$ , a  $\phi 12$  silver seal (pivot seal) is labeled on the one surface of the lock body (on the surface opposite from the unlocking port). The seal is meant for dust prevention, but even if it's peeled off, there would be no problem functionally. However, never disassemble the internal parts.

### Holding the Unlocked State

#### Warning

- $\phi 20$  to  $\phi 32$  can hold the unlocked condition.

<Holding the unlocked state>

- Remove the dust cover.
- Supply air pressure of 0.2 MPa or more to the unlocking port, and set the lock ring to the perpendicular position.
- Screw the attached bolt for unlocking (hexagon socket head cap screw/ $\phi 20$ ,  $\phi 25$ : M3 x 5 L,  $\phi 32$ : M3 x 10 L) into the lock ring to hold the unlocked condition.

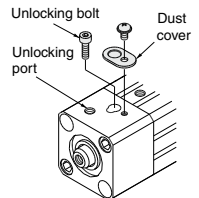

- To use the lock mechanism again, be sure to remove the unlocking bolt.

When the unlocking bolt is screwed in, the lock mechanism does not function. Remove the unlocking bolt according to the steps prescribed in the section of "Preparing for Operation".