

Fine Lock Cylinder

Double Acting, Single Rod

Series CLA2

∅40, ∅50, ∅63, ∅80, ∅100

How to Order

CLA2 **L** **50** **-100** **JN** **-E** **-**

With auto switch **CDLA2** **L** **50** **-100** **JN** **-E** **-M9BW** **-**

With auto switch (Built-in magnet)

Mounting

B	Basic
L	Axial foot
F	Rod flange
G	Head flange

C	Single clevis
D	Double clevis
T	Center trunnion

Tube material

Nil	Aluminum tube
F*	Steel tube
H	Air-hydro type

* Not available with auto switch.

Port thread type

Nil	Rc
TN	NPT

Bore size

40	40 mm
50	50 mm
63	63 mm
80	80 mm
100	100 mm

Cylinder stroke [mm]

For details, refer to page 2.

Auto switch

Nil Without auto switch

* For applicable auto switches, refer to the table below.

Lock operation

E	Spring locking (Exhaust locking)
P	Pneumatic locking (Pressure locking)
D	Spring and pneumatic locking

Number of auto switches

Nil	2 pcs.
S	1 pc.
n	"n" pcs.

Made to Order

For details, refer to page 2.

With rod boot/cushion

Rod boot	Nil	Without rod boot
	J	Nylon tarpaulin
	K	Heat resistant tarpaulin
Cushion	Nil	With cushion on both sides
	N	Without cushion

* Air-hydro type has no cushion.

Built-in Magnet Cylinder Model

If a built-in magnet cylinder without an auto switch is required, there is no need to enter the symbol for the auto switch.
(Example) CDLA2L40-100-E

Applicable Auto Switches/Refer to the Best Pneumatics No. 3 for further information on auto switches.

Type	Special function	Electrical entry	Indicator light	Wiring (Output)	Load voltage		Auto switch model		Lead wire length [m]				Pre-wired connector	Applicable load				
					DC	AC	Tie-rod mounting	Band mounting	0.5 (Nil)	1 (M)	3 (L)	5 (Z)						
Solid state auto switch	—	Grommet	—	3-wire (NPN)	24 V	5 V, 12 V	—	M9N	●	●	●	○	○	IC circuit	Relay, PLC			
				3-wire (PNP)				—	●	—	●	○	○					
				2-wire				—	●	●	●	○	○					
		Terminal conduit		3-wire (NPN)	24 V	12 V	—	G39C	—	—	—	—	—			—	—	
				2-wire				K39C	—	—	—	—	—					
				3-wire (NPN)				M9NW	—	●	●	●	○			○		
	Diagnostic indication (2-color indication)	Grommet	Yes	3-wire (PNP)	24 V	5 V, 12 V	—	M9PW	●	●	●	○	○	IC circuit				
				2-wire				—	●	●	●	○	○					
				3-wire (NPN)				M9BW	—	●	●	●	○			○		
		Water resistant (2-color indication)		Grommet	No	3-wire (NPN)	24 V	5 V, 12 V	—	M9NA**	—	○	○	●		○	—	
						3-wire (PNP)				M9PA**	—	○	○	●		○		○
						2-wire				M9BA**	—	○	○	●		○		○
	With diagnostic output (2-color indication)	Grommet	Yes	4-wire (NPN)		24 V	5 V, 12 V	—	F59F	●	—	●	○	○		IC circuit		
				2-wire (Non-polar)					P3DWA	—	—	—	●	●			○	○
Reed auto switch	—	Grommet		Yes		3-wire (NPN equivalent)	24 V	5 V	—	A96	—	●	—	—	—	IC circuit	Relay, PLC	
					2-wire	A93				—	●	—	●	—	—			
					Terminal conduit	100 V				A90	—	●	—	●	—			—
						100 V or less				A54	—	●	—	●	●			—
			100 V, 200 V			A64				—	●	—	●	—	—			
		DIN terminal	200 V or less		A33C	—	—	—	—	—	—							
			100 V, 200 V		A34C	—	—	—	—	—	—							
		Diagnostic indication (2-color indication)	Grommet		No	2-wire	24 V	12 V	—	A44C	—	—	—	—	—	—		PLC
						2-wire				A59W	—	—	—	—	—			

** Water resistant type auto switches can be mounted on the above models, but in such case SMC cannot guarantee water resistance. Please contact SMC regarding water resistant types with the above model numbers.

* Lead wire length symbols: 0.5 m..... Nil (Example) M9NW * Solid state auto switches marked with "○" are produced upon receipt of order.
1 m..... M (Example) M9NWM
3 m..... L (Example) M9NWL
5 m..... Z (Example) M9NWX

* Since there are other applicable auto switches than listed above, refer to page 23 for details.

* For details about auto switches with pre-wired connector, refer to the Best Pneumatics No. 3. For the D-P3DWA□, refer to the **WEB catalog**.

* The D-A9□/M9□□□/P3DWA□ auto switches are shipped together, (but not assembled). (However, auto switch mounting brackets are assembled for the D-A9□/M9□□□ before shipment.)

Series CLA2

Provided with a compact lock mechanism, it is suitable for intermediate stop, emergency stop, and drop prevention.



Made to Order

Symbol	Specifications
-XA□	Change of rod end shape
-XC3	Special port location
-XC6	Piston rod and rod end nut made of stainless steel
-XC11	Dual stroke cylinder/Single rod type
-XC14	Change of trunnion bracket mounting position
-XC15	Change of tie-rod length
-XC22	Fluororubber seal
-XC35	With coil scraper

Caution

Recommended Pneumatic Circuit/Caution on Handling

For detailed specifications mentioned above, refer to "Specific Product Precautions 3".

Refer to pages 18 to 23 for cylinders with auto switches.

- Minimum stroke for auto switch mounting
- Auto switch proper mounting position (detection at stroke end) and its mounting height
- Operating range
- Auto switch mounting brackets/Part no.

Minimum Stroke for Auto Switch Mounting

Caution

1. The minimum stroke for mounting varies with the auto switch type and cylinder mounting type. In particular, the center trunnion type needs careful attention. (For details, refer to pages 20 and 21.)

Accessories

Mounting		Basic	Axial foot	Rod flange	Head flange	Single clevis	Double clevis	Center trunnion
Standard	Rod end nut	●	●	●	●	●	●	●
	Clevis pin	—	—	—	—	—	●	—
Option	Single knuckle joint	●	●	●	●	●	●	●
	Double knuckle joint (with pin)	●	●	●	●	●	●	●
	With rod boot	●	●	●	●	●	●	●

Specifications

Bore size [mm]	40	50	63	80	100	40	50	63	80	100
Type	Non-lube					Air-hydro				
Fluid	Air					Turbine oil (Lock portion is air)				
Action	Double acting									
Proof pressure	1.5 MPa									
Maximum operating pressure	1.0 MPa									
Minimum operating pressure	0.08 MPa					0.2 MPa				
Piston speed	50 to 500 mm/sec*					15 to 300 mm/sec*				
Ambient and fluid temperature	Without auto switch: -10°C to 70°C With auto switch: -10°C to 60°C (No freezing)					5°C to 60°C				
Cushion	Air cushion					None				
Stroke length tolerance	Up to 250: $^{+1.0}_0$, 251 to 1000: $^{+1.4}_0$, 1001 to 1500: $^{+1.8}_0$									
Mounting	Basic, Axial foot, Rod flange, Head flange, Single clevis, Double clevis, Center trunnion									

* Constraints associated with the allowable kinetic energy are imposed on the speeds at which the piston can be locked.

Lock Specifications

Lock operation	Spring locking (Exhaust locking)	Spring and pneumatic locking	Pneumatic locking (Pressure locking)
Unlocking pressure [MPa]	0.3 or more		0.1 or more
Lock starting pressure [MPa]	0.25 or less		0.05 or more
Maximum operating pressure [MPa]	1.0	0.5	
Locking direction	Both directions		

Standard Strokes

Bore size [mm]	Standard stroke [mm] ^{Note 1)}	Long stroke [mm] ^{Note 2)}
40	25, 50, 75, 100, 125, 150, 175, 200, 250, 300, 350, 400, 450, 500	800
50, 63	25, 50, 75, 100, 125, 150, 175, 200, 250, 300, 350, 400, 450, 500, 600	1200
80, 100	25, 50, 75, 100, 125, 150, 175, 200, 250, 300, 350, 400, 450, 500, 600, 700	ø80: 1400 ø100: 1500

Note 1) Intermediate strokes not listed above are produced upon receipt of order. Spacers are not used for intermediate strokes.

Note 2) Long strokes are applicable for the axial foot and rod flange types.

Rod Boot Material

Symbol	Rod boot material	Max. ambient temperature
J	Nylon tarpaulin	70°C
K	Heat resistant tarpaulin	110°C*

* Maximum ambient temperature for the rod boot

Fine Lock Cylinder: Double Acting, Single Rod **Series CLA2**

Weights

[kg]

Bore size [mm]		40	50	63	80	100		
Basic weight	Basic	Aluminum tube	1.77	2.68	4.27	6.95	9.86	
		Steel tube	1.82	2.72	4.31	7.11	10.07	
	Axial foot	Aluminum tube	1.96	2.90	4.61	7.62	10.85	
		Steel tube	2.01	2.94	4.65	7.78	11.06	
	Flange	Aluminum tube	2.14	3.13	5.06	8.40	11.78	
		Steel tube	2.19	3.17	5.10	8.56	11.99	
	Single clevis	Aluminum tube	2.00	3.02	4.90	8.06	11.64	
		Steel tube	2.05	3.06	4.94	8.22	11.85	
	Double clevis	Aluminum tube	2.04	3.11	5.06	8.35	12.16	
		Steel tube	2.09	3.15	5.10	8.51	12.37	
	Center trunnion	Aluminum tube	2.22	3.21	5.16	8.65	12.26	
		Steel tube	2.32	3.31	5.36	8.94	12.65	
	Additional weight per 50 mm of stroke	All mounting brackets	Aluminum tube	0.20	0.25	0.31	0.46	0.58
			Steel tube	0.28	0.35	0.43	0.70	0.87
Accessories	Single knuckle		0.23	0.26	0.26	0.60	0.83	
	Double knuckle (with pin)		0.37	0.43	0.43	0.87	1.27	

Calculation: (Example) **CLA2L40-100-E** Basic weight.....1.96 (Axial foot, ø40)
 Additional weight.....0.20/50 stroke
 Cylinder stroke.....100 stroke
 $1.96 + 0.20 \times 100/50 = 2.36$ kg

Mounting Brackets/Part No.

Bore size [mm]	40	50	63	80	100
Axial foot*	CA2-L04	CA2-L05	CA2-L06	CA2-L08	CA2-L10
Flange	CA2-F04	CA2-F05	CA2-F06	CA2-F08	CA2-F10
Single clevis	CA2-C04	CA2-C05	CA2-C06	CA2-C08	CA2-C10
Double clevis**	CA2-D04	CA2-D05	CA2-D06	CA2-D08	CA2-D10

* When axial foot brackets are used, order two pieces per cylinder.
 ** A clevis pin, flat washers and split pins are shipped together with double clevis.

Series CLA2

⚠ Caution/Maximum load when Locking

Allowable kinetic energy when in a locked state

Bore size [mm]	40	50	63	80	100
Allowable kinetic energy [J]	1.42	2.21	3.53	5.69	8.83

- In terms of specific load conditions, the allowable kinetic energy indicated in the table above is equivalent to a 50% load ratio at 0.5 MPa, and a piston speed of 300 mm/s. Therefore, if the operating conditions are below these values, calculations are unnecessary.
- Apply the following formula to obtain the kinetic energy of the load.

$$E_k = \frac{1}{2} m v^2$$
 Ek: Kinetic energy of load [J]
 m : Load mass [kg]
 v : Piston speed [m/s]
- The piston speed will exceed the average speed immediately before locking. To determine the piston speed for the purpose of obtaining the kinetic energy of load, use 1.2 times the average speed as a guide.
- The relationship between the speed and the load is indicated in the diagram below. The area under the line is the allowable operating range.
- Even if the product is operated within the allowable kinetic energy, there is an upper limit to the size of load that can be sustained. Thus, a horizontally mounted cylinder must be operated below the solid line, and a vertically mounted cylinder must be operated below the dotted line.
- The graph below is based on use at the intermediate stop (including emergency stops during operation). However, when the cylinder is in a locked state, such as for drop prevention, kinetic energy does not act upon it. Under these conditions, the max. load mass for a vertically mounted cylinder is the max. load mass when the piston speed is 50 mm/s.

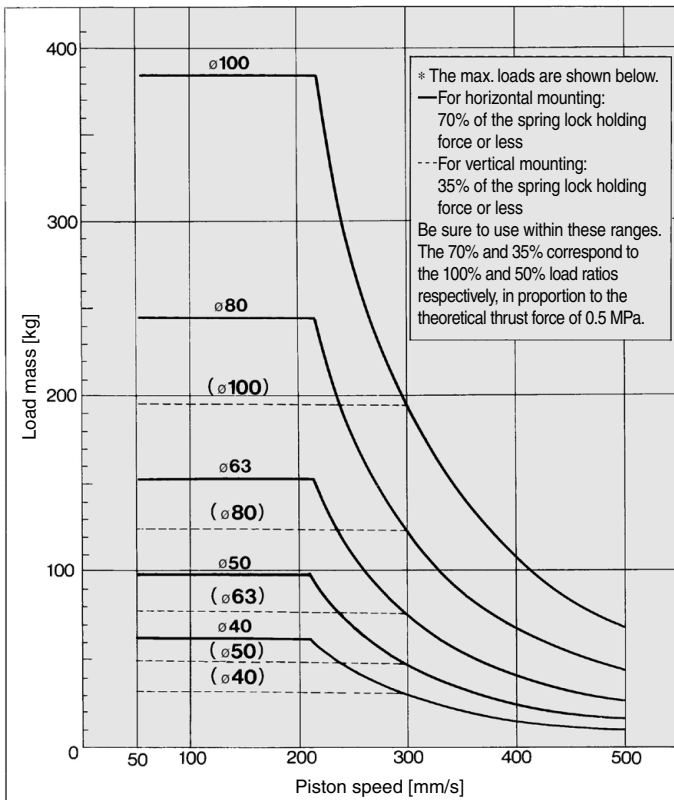

Stopping Accuracy (Not including tolerance of control system) [mm]

Locking method	Piston speed [mm/sec]			
	50	100	300	500
Spring locking	±0.4	±0.5	±1.0	±2.0
Pneumatic locking Spring and pneumatic locking	±0.2	±0.3	±0.5	±1.5

Conditions/Load: 25% of output at 0.5 MPa
 Solenoid valve: Mounted to the lock port

Holding Force of Spring Locking (Maximum static load)

Bore size [mm]	40	50	63	80	100
Holding force [N]	882	1370	2160	3430	5390

- Note1) Holding force (max. static load) refers to the highest load that can be statically held without vibrations or impact when no load is applied. Therefore, it does not refer to loads that can be held regularly. Check the max. load when in a locked state in the graph on the left.
- Note2) Holding force at piston rod retracted side decreases approximately 15%.

Holding Force of Pneumatic Locking

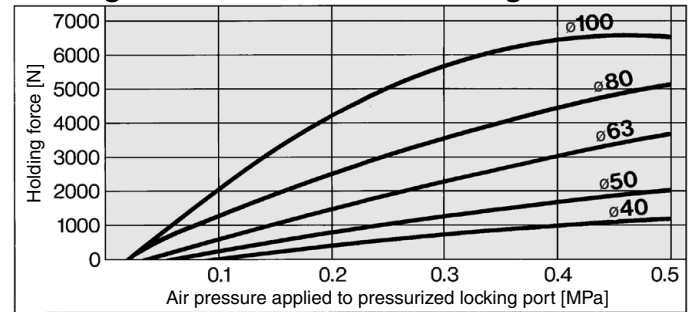

- Note1) Holding force (max. static load) refers to the highest load that can be statically held without vibrations or impact when no load is applied. Therefore, it does not refer to loads that can be held regularly. Check the max. load when in a locked state in the graph on the left.
- Note2) Holding force at piston rod retracted side decreases approximately 15%.
- Note3) Taking the possibility of air supply cutoff into consideration, pneumatic locks should not be used for drop prevention.

Holding Force of Spring and Pneumatic Locking

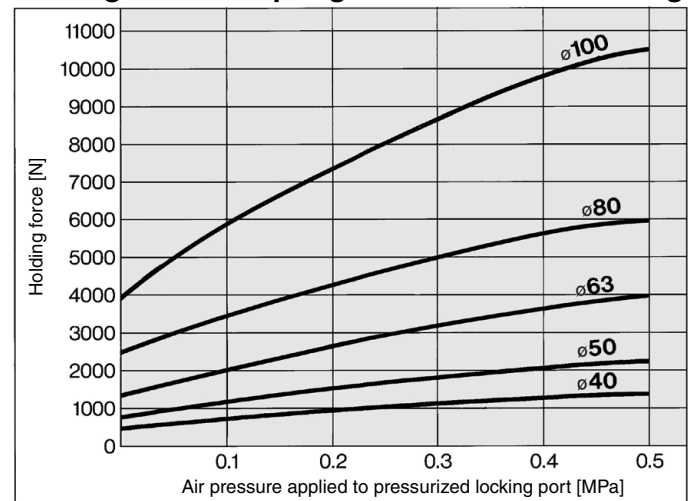

- Note1) Holding force (max. static load) refers to the highest load that can be statically held without vibrations or impact when no load is applied. Therefore, it does not refer to loads that can be held regularly. Check the max. load when in a locked state in the graph on the left.
- Note2) Holding force at piston rod retracted side decreases approximately 15%.

⚠ Caution

Caution when Locking

- If the piston rod slips because the lock's holding force has been exceeded, the brake shoe could be damaged, resulting in a reduced holding force or shortened life.
- Do not use the cylinder in the locked state to sustain a load that involves impact.

Fine Lock Cylinder: Double Acting, Single Rod *Series CLA2*

Construction

Non-lube type

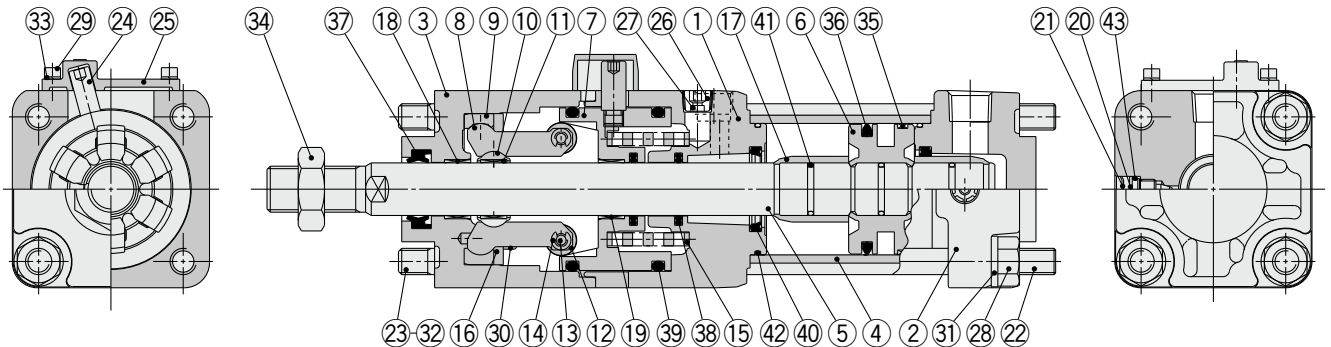

Air-hydro type

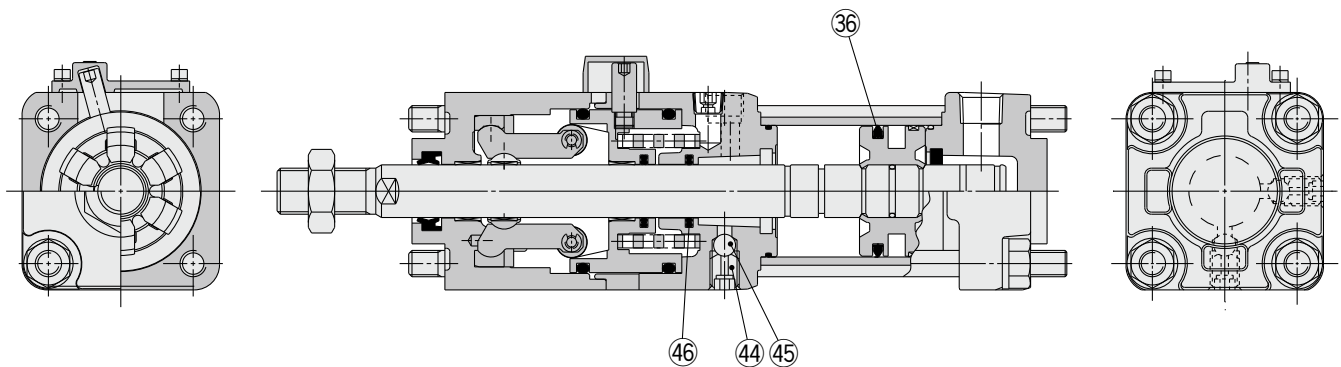

Component Parts

No.	Description	Material	Note
1	Rod cover	Aluminum alloy	Metallic painted after hard anodized
2	Head cover	Aluminum alloy	Metallic painted
3	Cover	Aluminum alloy	Metallic painted after hard anodized
4	Cylinder tube	Aluminum alloy	Hard anodized
5	Piston rod	Carbon steel	Hard chrome plating
6	Piston	Aluminum alloy	Chromated
7	Brake piston	Carbon steel	Nitriding
8	Brake arm	Carbon steel	Nitriding
9	Arm holder	Carbon steel	Nitriding
10	Brake shoe holder	Carbon steel	Nitriding
11	Brake shoe	Special friction material	
12	Roller	Chromium molybdenum steel	Nitriding
13	Pin	Chrome bearing steel	Heat treated
14	Retaining ring	Carbon tool steel	
15	Brake spring	Steel wire	Anti-corrosive treatment: Except type P
16	Retaining plate	Rolled steel	Zinc chromated
17	Cushion ring	Aluminum alloy	Anodized
18	Bushing	Copper alloy	
19	Bushing	Copper alloy	
20	Cushion valve	Steel wire	Electroless nickel plating
21	Retaining ring	Spring steel	
22	Tie-rod	Carbon steel	Zinc chromated
23	Unit holding tie-rod	Carbon steel	Chromated
24	Non-rotating pin	Carbon steel	Heat treated
25	Pin guide	Carbon steel	Metallic painted after nitriding
26	Hexagon socket head plug	Carbon steel	Type E only
27	Element	Bronze	Type E only
28	Tie-rod nut	Rolled steel	
29	Hexagon socket head cap screw	Chromium molybdenum steel	
30	Retaining plate mounting bolt	Chromium molybdenum steel	
31	Spring washer	Steel wire	
32	Spring washer	Steel wire	
33	Spring washer	Steel wire	
34	Rod end nut	Rolled steel	
35	Wear ring	Resin	
36	Piston seal	NBR	
37	Rod seal A	NBR	
38	Rod seal B	NBR	
39	Brake piston seal	NBR	
40	Cushion seal	Urethane	
41	Piston gasket	NBR	

No.	Description	Material	Note
42	Tube gasket	NBR	
43	Cushion valve seal	NBR	
44	Air release valve	Chromium molybdenum steel	Black zinc chromated
45	Check ball	Chrome bearing steel	
46	Rod seal C	NBR	

Replacement Parts: Seal Kit

Bore size [mm]	Kit no.	Contents
40	MB1-40Z-PS	Set of the nos. 36, 37, 40, 42
50	MB1-50Z-PS	
63	MB1-63Z-PS	
80	MB1-80Z-PS	
100	MB1-100Z-PS	

* Since the lock of the CLA2 series cannot be disassembled and is normally replaced as a unit, kits are for the cylinder section only. These can be ordered using the order number for each bore size.

* Seal kit includes a grease pack (ø40, ø50: 10 g, ø63, ø80: 20 g, ø100: 30 g). Order with the following part number when only the grease pack is needed.

Grease pack part number: GR-S-010 (10 g), GR-S-020 (20 g)

* Please consult with SMC for seal kits of the air-hydro type.

Replacement Fine Lock Unit

CLA2 - 40 - E

Bore size

40	40 mm
50	50 mm
63	63 mm
80	80 mm
100	100 mm

Port thread type

Nil	Rc port
TN	NPT port

Suffix

Nil	Standard
L*	Long stroke

* The lock unit for a long-stroke cylinder is only applicable for flange type with bore size ø50 to ø100 and stroke 1001 or more. (Example: CLA2-100-EL)

Lock operation

E	Spring locking (Exhaust locking)
P	Pneumatic locking (Pressure locking)
D	Spring and pneumatic locking

* Please consult with SMC for replacement fine lock units of the air-hydro type.

Series CLA2

Basic: CLA2B

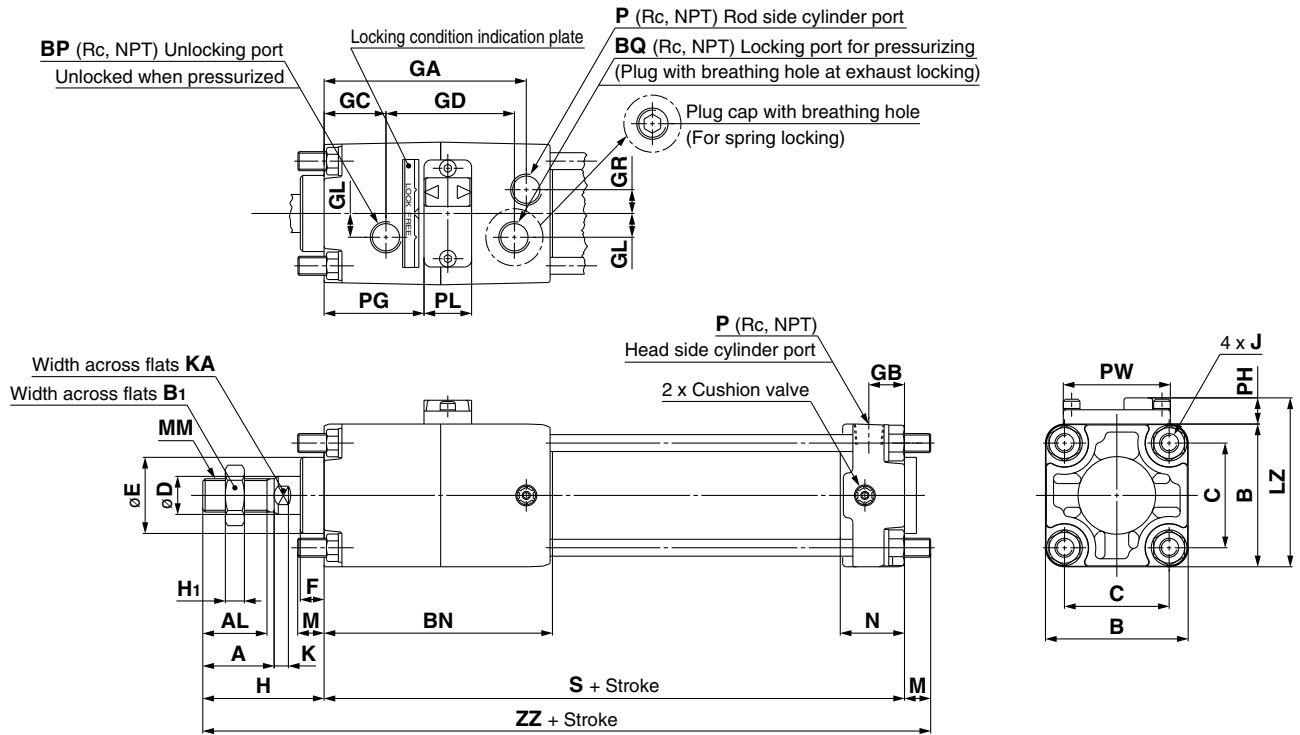

With rod boot

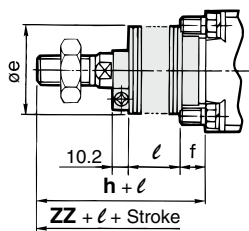

[mm]

Bore size [mm]	Stroke range [mm]		A	AL	B	B ₁	BN	BP	BQ	C	D	E	F	GA	GB	GC	GD	GL	GR	H ₁	J
	Without rod boot	With rod boot																			
40	Up to 500	20 to 500	30	27	60	22	96	1/4	1/4	44	16	32	10	85	15	26	54	10	10	8	M8 x 1.25
50	Up to 600	20 to 600	35	32	70	27	108	1/4	1/4	52	20	40	10	95	17	27	59	13	12	11	M8 x 1.25
63	Up to 600	20 to 600	35	32	86	27	115	1/4	1/4	64	20	40	10	102	17	26	67	18	15	11	M10 x 1.25
80	Up to 750	20 to 750	40	37	102	32	129	1/4	1/4	78	25	52	14	113	21	30	72	23	17	13	M12 x 1.75
100	Up to 750	20 to 750	40	37	116	41	140	1/4	1/4	92	30	52	14	124	21	31	76	25	19	16	M12 x 1.75

Bore size [mm]	K	KA	LZ	M	MM	N	P	PG	PH	PL	PW	S	Without rod boot		With rod boot				
													H	ZZ	e	f	h	l	ZZ
40	6	14	71	11	M14 x 1.5	27	1/4	42	11	20	45	153	51	215	43	11.2	59	1/4 stroke	223
50	7	18	80	11	M18 x 1.5	30	3/8	46	10	21	50	168	58	237	52	11.2	66	1/4 stroke	245
63	7	18	99	14	M18 x 1.5	31	3/8	48.5	13	23	60	182	58	254	52	11.2	66	1/4 stroke	262
80	10	22	117	17	M22 x 1.5	37	1/2	55	15	23	70	208	71	296	65	12.5	80	1/4 stroke	305
100	10	26	131	17	M26 x 1.5	40	1/2	56.5	15	25	80	226	72	315	65	14	81	1/4 stroke	324

Fine Lock Cylinder: Double Acting, Single Rod *Series CLA2*

Axial Foot: CLA2L

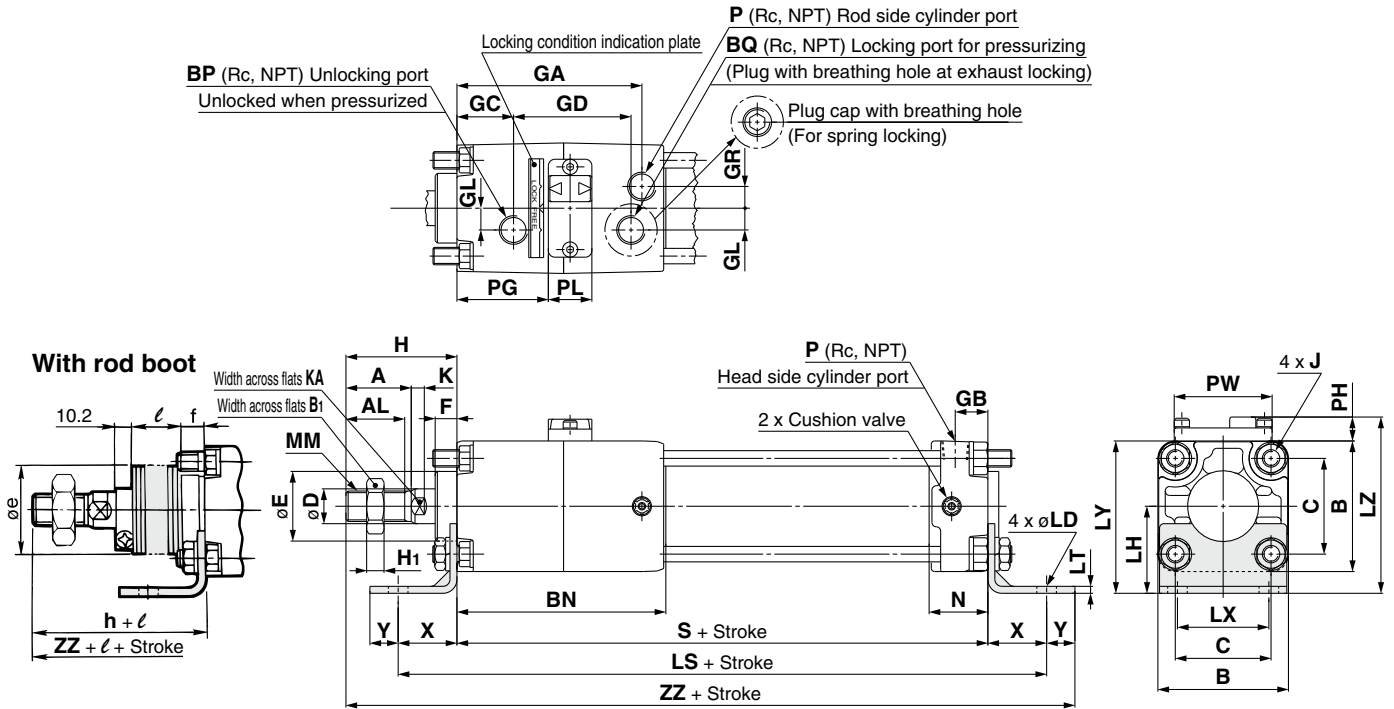

Long stroke
(Stroke of 1001 mm or more)
ø50 to ø100

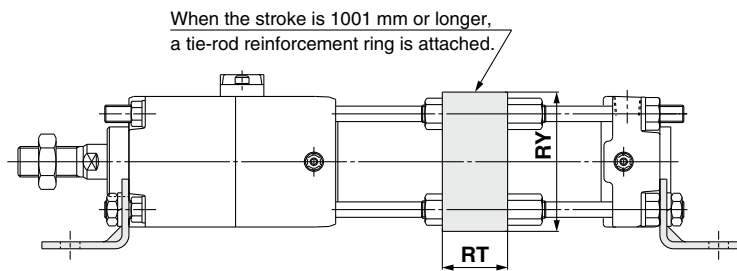

Bore size [mm]	Stroke range [mm]		A	AL	B	B ₁	BN	BP	BQ	C	D	E	F	GA	GB	GC	GD	GL	GR
	Without rod boot	With rod boot																	
40	Up to 800	20 to 800	30	27	60	22	96	1/4	1/4	44	16	32	10	85	15	26	54	10	10
50	Up to 1200	20 to 1200	35	32	70	27	108	1/4	1/4	52	20	40	10	95	17	27	59	13	12
63	Up to 1200	20 to 1200	35	32	86	27	115	1/4	1/4	64	20	40	10	102	17	26	67	18	15
80	Up to 1400	20 to 1400	40	37	102	32	129	1/4	1/4	78	25	52	14	113	21	30	72	23	17
100	Up to 1500	20 to 1500	40	37	116	41	140	1/4	1/4	92	30	52	14	124	21	31	76	25	19

Bore size [mm]	H ₁	J	K	KA	LD	LH	LS	LT	LX	LY	LZ	MM	N	P	PG	PH	PL	PW	RT	RY	S	X
40	8	M8 x 1.25	6	14	9	40	207	3.2	42	70	81	M14 x 1.5	27	1/4	42	11	20	45	—	—	153	27
50	11	M8 x 1.25	7	18	9	45	222	3.2	50	80	90	M18 x 1.5	30	3/8	46	10	21	50	30	76	168	27
63	11	M10 x 1.25	7	18	11.5	50	250	3.2	59	93	106	M18 x 1.5	31	3/8	48.5	13	23	60	40	92	182	34
80	13	M12 x 1.75	10	22	13.5	65	296	4.5	76	116	131	M22 x 1.5	37	1/2	55	15	23	70	45	112	208	44
100	16	M12 x 1.75	10	26	13.5	75	312	6	92	133	148	M26 x 1.5	40	1/2	56.5	15	25	80	50	136	226	43

Bore size [mm]	Y	Without rod boot		With rod boot				
		H	ZZ	e	f	h	ℓ	ZZ
40	13	51	244	43	11.2	59	1/4 stroke	252
50	13	58	266	52	11.2	66	1/4 stroke	274
63	16	58	290	52	11.2	66	1/4 stroke	298
80	16	71	339	65	12.5	80	1/4 stroke	348
100	17	72	358	65	14.0	81	1/4 stroke	367

Series CLA2

Rod Flange: CLA2F

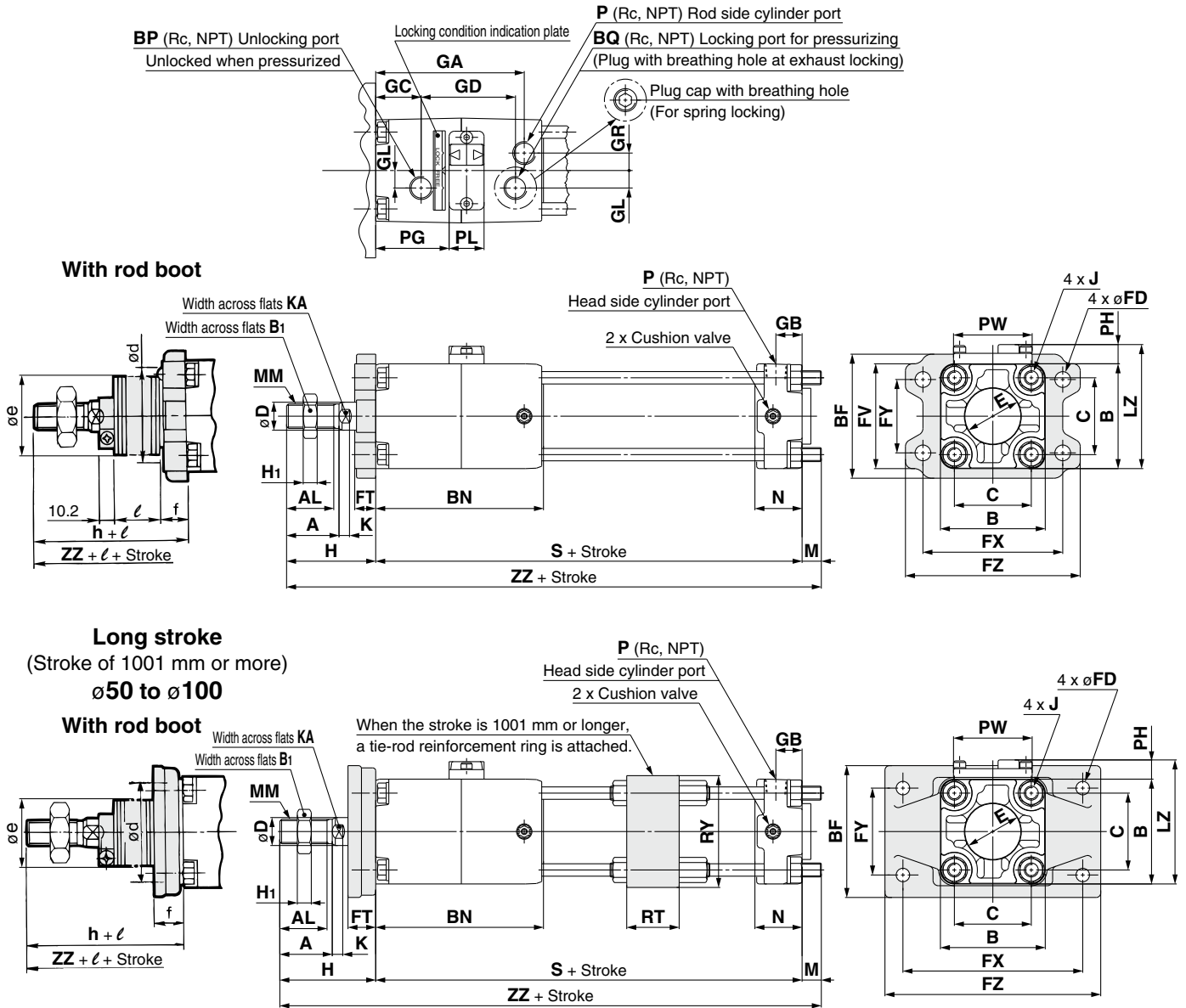

Bore size [mm]	Stroke range [mm]																							[mm]			
	Without rod boot	With rod boot	A	AL	B	B ₁	BF	BN	BP	BQ	C	D	E	GA	GB	GC	GD	GL	GR	H ₁	J	K	KA	LZ			
40	Up to 800	20 to 800	30	27	60	22	71	96	1/4	1/4	44	16	32	85	15	26	54	10	10	8	M8 x 1.25	6	14	71			
50	Up to 1000	20 to 1000	35	32	70	27	81	108	1/4	1/4	52	20	40	95	17	27	59	13	12	11	M8 x 1.25	7	18	80			
63	Up to 1000	20 to 1000	35	32	86	27	101	115	1/4	1/4	64	20	40	102	17	26	67	18	15	11	M10 x 1.25	7	18	99			
80	Up to 1000	20 to 1000	40	37	102	32	119	129	1/4	1/4	78	25	52	113	21	30	72	23	17	13	M12 x 1.75	10	22	117			
100	Up to 1000	20 to 1000	40	37	116	41	133	140	1/4	1/4	92	30	52	124	21	31	76	25	19	16	M12 x 1.75	10	26	131			

Bore size [mm]	M	MM	N	P	PG	PH	PL	PW	S	FV	FD	FT	FX	FY	FZ	Without rod boot		With rod boot					
																H	ZZ	d*	e*	f	h	ℓ	ZZ
40	11	M14 x 1.5	27	1/4	42	11	20	45	153	60	9	12	80	42	100	51	215	52	43	15	59	1/4 stroke	223
50	11	M18 x 1.5	30	3/8	46	10	21	50	168	70	9	12	90	50	110	58	237	58	52	15	66	1/4 stroke	245
63	14	M18 x 1.5	31	3/8	48.5	13	23	60	182	86	11.5	15	105	59	130	58	254	58	52	17.5	66	1/4 stroke	262
80	17	M22 x 1.5	37	1/2	55	15	23	70	208	102	13.5	18	130	76	160	71	296	80	65	21.5	80	1/4 stroke	305
100	17	M26 x 1.5	40	1/2	56.5	15	25	80	226	116	13.5	18	150	92	180	72	315	80	65	21.5	81	1/4 stroke	324

Long Stroke

Dimensions other than below are the same as the table above.

Bore size [mm]	Stroke range [mm]	BF	M	RT	RY	FT	FX	FY	FZ	Without rod boot		With rod boot		
										H	ZZ	f	h	ZZ
50	1001 to 1200	88	6	30	76	20	120	58	144	67	241	19	66	240
63	1001 to 1200	105	10	40	92	23	140	64	170	71	263	19	66	258
80	1001 to 1400	124	12	45	112	28	164	84	198	87	307	21	80	300
100	1001 to 1500	140	12	50	136	29	180	100	220	89	327	21	81	319

* When a hole must be made to accommodate the rod portion, make sure to machine a hole that is larger than the outer diameter of the rod boot mounting bracket ϕd for the standard stroke and the rod boot outer diameter ϕe for a long stroke.

Fine Lock Cylinder: Double Acting, Single Rod *Series CLA2*

Head Flange: CLA2G

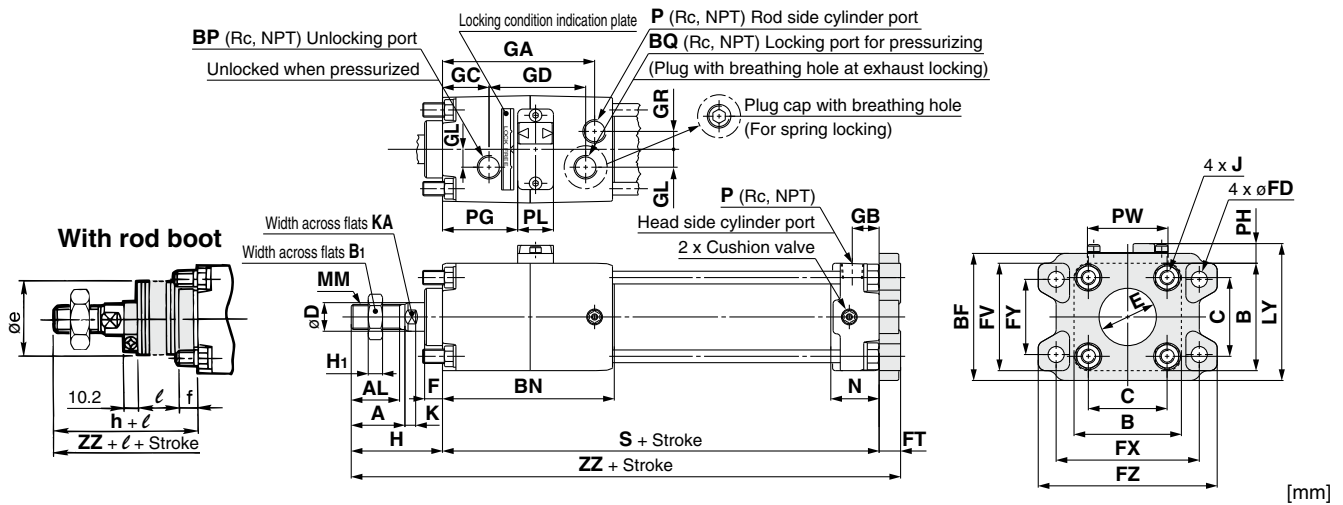

Bore size [mm]	Stroke range [mm]		A	AL	B	B ₁	BN	BP	BQ	C	D	E	F	FV	FD	FT	FX	FY	FZ	GA	GB	GC	GD	GL	
	Without rod boot	With rod boot																							
40	Up to 500	20 to 500	30	27	60	22	71	96	1/4	1/4	44	16	32	10	60	9	12	80	42	100	85	15	26	54	10
50	Up to 600	20 to 600	35	32	70	27	81	108	1/4	1/4	52	20	40	10	70	9	12	90	50	110	95	17	27	59	13
63	Up to 600	20 to 600	35	32	86	27	101	115	1/4	1/4	64	20	40	10	86	11.5	15	105	59	130	102	17	26	67	18
80	Up to 750	20 to 750	40	37	102	32	119	129	1/4	1/4	78	25	52	14	102	13.5	18	130	76	160	113	21	30	72	23
100	Up to 750	20 to 750	40	37	116	41	133	140	1/4	1/4	92	30	52	14	116	13.5	18	150	92	180	124	21	31	76	25

Bore size [mm]	GR	H ₁	J	K	KA	LY	MM	N	P	PG	PH	PL	PW	S	Without rod boot		With rod boot				
															H	ZZ	e	f	h	l	ZZ
40	10	8	M8 x 1.25	6	14	76.5	M14 x 1.5	27	1/4	42	11	20	45	153	51	216	43	11.2	59	1/4 stroke	224
50	12	11	M8 x 1.25	7	18	85.5	M18 x 1.5	30	3/8	46	10	21	50	168	58	238	52	11.2	66	1/4 stroke	246
63	15	11	M10 x 1.25	7	18	106.5	M18 x 1.5	31	3/8	48.5	13	23	60	182	58	255	52	11.2	66	1/4 stroke	263
80	17	13	M12 x 1.75	10	22	125.5	M22 x 1.5	37	1/2	55	15	23	70	208	71	297	65	12.5	80	1/4 stroke	306
100	19	16	M12 x 1.75	10	26	139.5	M26 x 1.5	40	1/2	56.5	15	25	80	226	72	316	65	14.0	81	1/4 stroke	325

Single Clevis: CLA2C

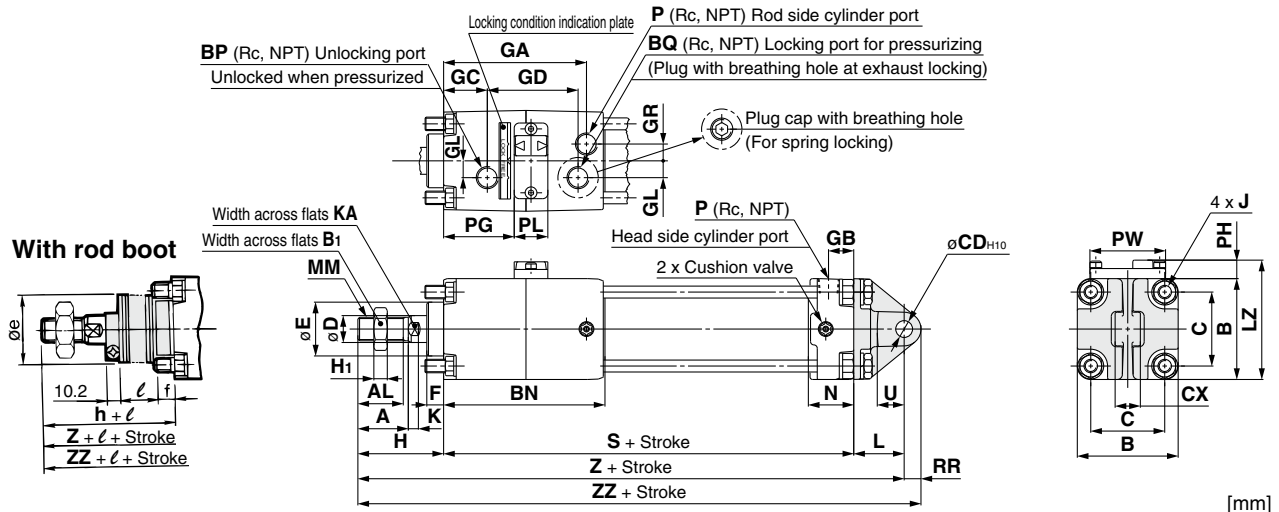

Bore size [mm]	Stroke range [mm]		A	AL	B	B ₁	BN	BP	BQ	C	CD _{H10}	CX	D	E	F	GA	GB	GC	GD	GL	GR	H ₁
	Without rod boot	With rod boot																				
40	Up to 500	20 to 500	30	27	60	22	96	1/4	1/4	44	10 ^{+0.058} ₀	15 ^{-0.1} _{-0.3}	16	32	10	85	15	26	54	10	10	8
50	Up to 600	20 to 600	35	32	70	27	108	1/4	1/4	52	12 ^{+0.070} ₀	18 ^{-0.1} _{-0.3}	20	40	10	95	17	27	59	13	12	11
63	Up to 600	20 to 600	35	32	86	27	115	1/4	1/4	64	16 ^{+0.070} ₀	25 ^{-0.1} _{-0.3}	20	40	10	102	17	26	67	18	15	11
80	Up to 750	20 to 750	40	37	102	32	129	1/4	1/4	78	20 ^{+0.084} ₀	31.5 ^{-0.1} _{-0.3}	25	52	14	113	21	30	72	23	17	13
100	Up to 750	20 to 750	40	37	116	41	140	1/4	1/4	92	25 ^{+0.084} ₀	35.5 ^{-0.1} _{-0.3}	30	52	14	124	21	31	76	25	19	16

Bore size [mm]	J	K	KA	L	LZ	MM	N	P	PG	PH	PL	PW	RR	S	U	Without rod boot		With rod boot						
																H	Z	ZZ	e	f	h	l	Z	ZZ
40	M8 x 1.25	6	14	30	71	M14 x 1.5	27	1/4	42	11	20	45	10	153	16	51	234	244	43	11.2	59	1/4 stroke	242	252
50	M8 x 1.25	7	18	35	80	M18 x 1.5	30	3/8	46	10	21	50	12	168	19	58	261	273	52	11.2	66	1/4 stroke	269	281
63	M10 x 1.25	7	18	40	99	M18 x 1.5	31	3/8	48.5	13	23	60	16	182	23	58	280	296	52	11.2	66	1/4 stroke	288	304
80	M12 x 1.75	10	22	48	117	M22 x 1.5	37	1/2	55	15	23	70	20	208	28	71	327	347	65	12.5	80	1/4 stroke	336	356
100	M12 x 1.75	10	26	58	131	M26 x 1.5	40	1/2	56.5	15	25	80	25	226	36	72	356	381	65	14.0	81	1/4 stroke	365	390

Series CLA2

Double Clevis: CLA2D

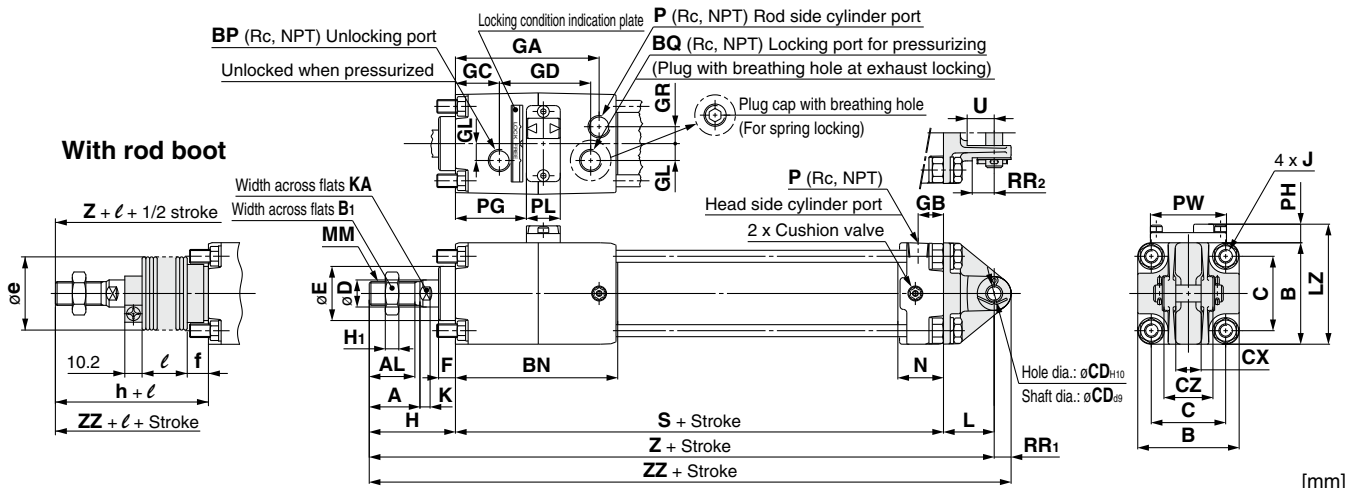

Bore size [mm]	Stroke range [mm]																						
	Without rod boot	With rod boot	A	AL	B	B ₁	BN	BP	BQ	C	CD _{H10}	CX	CZ	D	E	F	GA	GB	GC	GD	GL	GR	H ₁
40	Up to 500	20 to 500	30	27	60	22	96	1/4	1/4	44	ø10 ^{+0.058} ₀	15 ^{+0.3} _{-0.1}	29.5	16	32	10	85	15	26	54	10	10	8
50	Up to 600	20 to 600	35	32	70	27	108	1/4	1/4	52	ø12 ^{+0.070} ₀	18 ^{+0.3} _{-0.1}	38	20	40	10	95	17	27	59	13	12	11
63	Up to 600	20 to 600	35	32	86	27	115	1/4	1/4	64	ø16 ⁺⁰ ₀	25 ^{+0.3} _{-0.1}	49	20	40	10	102	17	26	67	18	15	11
80	Up to 750	20 to 750	40	37	102	32	129	1/4	1/4	78	ø20 ^{+0.084} ₀	31.5 ^{+0.3} _{-0.1}	61	25	52	14	113	21	30	72	23	17	13
100	Up to 750	20 to 750	40	37	116	41	140	1/4	1/4	92	ø25 ^{+0.084} ₀	35.5 ^{+0.3} _{-0.1}	64	30	52	14	124	21	31	76	25	19	16

Bore size [mm]																Without rod boot		With rod boot							
	J	K	KA	L	LZ	MM	N	P	PG	PH	PL	PW	RR ₁	RR ₂	S	U	H	Z	ZZ	e	f	h	l	Z	ZZ
40	M8 x 1.25	6	14	30	71	M14 x 1.5	27	1/4	42	11	20	45	10	16	153	16	51	234	244	43	11.2	59	1/4 stroke	242	252
50	M8 x 1.25	7	18	35	80	M18 x 1.5	30	3/8	46	10	21	50	12	19	168	19	58	261	273	52	11.2	66	1/4 stroke	269	281
63	M10 x 1.25	7	18	40	99	M18 x 1.5	31	3/8	48.5	13	23	60	16	23	182	23	58	280	296	52	11.2	66	1/4 stroke	288	304
80	M12 x 1.75	10	22	48	117	M22 x 1.5	37	1/2	55	15	23	70	20	28	208	28	71	327	347	65	12.5	80	1/4 stroke	336	356
100	M12 x 1.75	10	26	58	131	M26 x 1.5	40	1/2	56.5	15	25	80	25	23.5	226	36	72	356	381	65	14.0	81	1/4 stroke	365	390

* A clevis pin, flat washers and split pins are included.

Center Trunnion: CLA2T

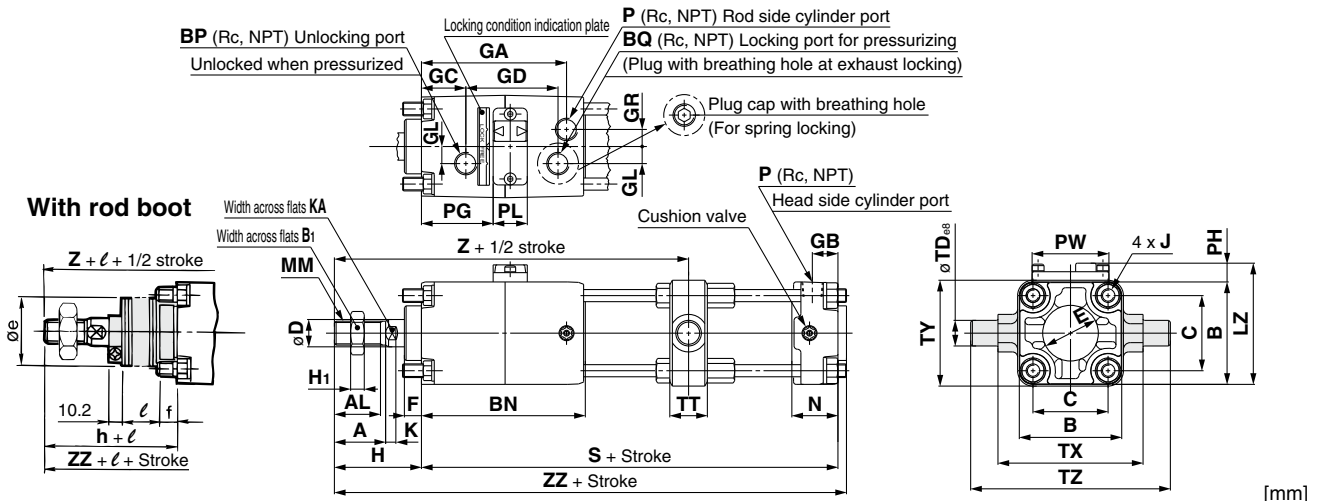

Bore size [mm]	Stroke range [mm]																							
	Without rod boot	With rod boot	A	AL	B	B ₁	BN	BP	BQ	C	D	E	F	GA	GB	GC	GD	GL	GR	H ₁	J	K	KA	LZ
40	25 to 500	25 to 500	30	27	60	22	96	1/4	1/4	44	16	32	10	85	15	26	54	10	10	8	M8 x 1.25	6	14	71
50	25 to 600	25 to 600	35	32	70	27	108	1/4	1/4	52	20	40	10	95	17	27	59	13	12	11	M8 x 1.25	7	18	80
63	32 to 600	32 to 600	35	32	86	27	115	1/4	1/4	64	20	40	10	102	17	26	67	18	15	11	M10 x 1.25	7	18	99
80	41 to 750	41 to 750	40	37	102	32	129	1/4	1/4	78	25	52	14	113	21	30	72	23	17	13	M12 x 1.75	10	22	117
100	45 to 750	45 to 750	40	37	116	41	140	1/4	1/4	92	30	52	14	124	21	31	76	25	19	16	M12 x 1.75	10	26	131

Bore size [mm]																Without rod boot		With rod boot					
	MM	N	P	PG	PH	PL	PW	S	TD _{es}	TT	TX	TY	TZ	H	Z	ZZ	e	f	h	l	Z	ZZ	
40	M14 x 1.5	27	1/4	42	11	20	45	153	15 ^{-0.032} _{-0.059}	22	85	62	117	51	162	209	43	11.2	59	1/4 stroke	170	217	
50	M18 x 1.5	30	3/8	46	10	21	50	168	15 ^{-0.032} _{-0.059}	22	95	74	127	58	181	232	52	11.2	66	1/4 stroke	189	240	
63	M18 x 1.5	31	3/8	48.5	13	23	60	182	18 ^{-0.032} _{-0.059}	28	110	90	148	58	191	246	52	11.2	66	1/4 stroke	199	254	
80	M22 x 1.5	37	1/2	55	15	23	70	208	25 ^{-0.040} _{-0.073}	34	140	110	192	71	221	286	65	12.5	80	1/4 stroke	230	295	
100	M26 x 1.5	40	1/2	56.5	15	25	80	226	25 ^{-0.040} _{-0.073}	40	162	130	214	72	235	306	65	14.0	81	1/4 stroke	244	315	

Series CLA2

Dimensions of Accessories

Y Type Double Knuckle Joint

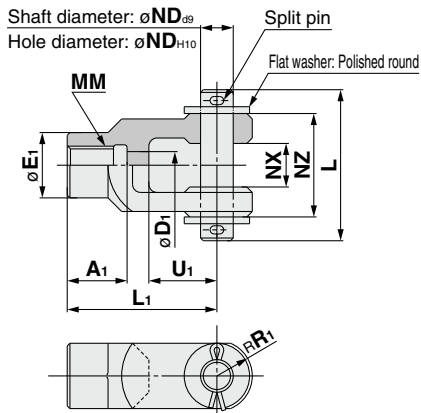

Material: Cast iron

[mm]

Part no.	Applicable bore size [mm]	A ₁	D ₁	E ₁	L	L ₁	MM	ND	NX	NZ	R ₁	U ₁	Split pin size	Flat washer size
Y-04D	40	22	10	24	55.5	55	M14 x 1.5	12	16 ^{+0.3} _{+0.1}	38	13	25	ø3 x 18ℓ	Polished round 12
Y-05D	50, 63	27	14	28	55.5	60	M18 x 1.5	12	16 ^{+0.3} _{+0.1}	38	15	27	ø3 x 18ℓ	Polished round 12
Y-08D	80	37	18	36	76.5	71	M22 x 1.5	18	28 ^{+0.3} _{+0.1}	55	19	28	ø4 x 25ℓ	Polished round 18
Y-10D	100	37	21	40	83	83	M26 x 1.5	20	30 ^{+0.3} _{+0.1}	61	21	38	ø4 x 30ℓ	Polished round 20

* A knuckle pin, split pins and flat washers are included.

Clevis Pin/Knuckle Pin

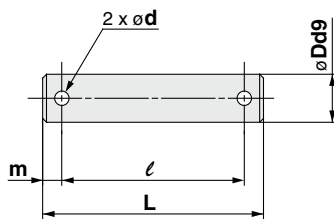

Material: Carbon steel

[mm]

Part no.	Applicable bore size		Dd9	d Drill through	L	ℓ	m	Included split pin	Included flat washer
	Clevis	Knuckle							
CDP-2A	40	—	10 ^{-0.040} _{-0.076}	3	46	38	4	ø3 x 18 ℓ	Polished round 10
CDP-3A	50	40, 50, 63	12 ^{-0.050} _{-0.093}	3	55.5	47.5	4	ø3 x 18 ℓ	Polished round 12
CDP-4A	63	—	16 ^{-0.050} _{-0.093}	4	71	61	5	ø4 x 25 ℓ	Polished round 16
CDP-5A	—	80	18 ^{-0.050} _{-0.093}	4	76.5	66.5	5	ø4 x 25 ℓ	Polished round 18
CDP-6A	80	100	20 ^{-0.065} _{-0.117}	4	83	73	5	ø4 x 30 ℓ	Polished round 20
CDP-7A	100	—	25 ^{-0.065} _{-0.117}	4	88	78	5	ø4 x 36 ℓ	Polished round 24

* Split pins and flat washers are included.

I Type Single Knuckle Joint

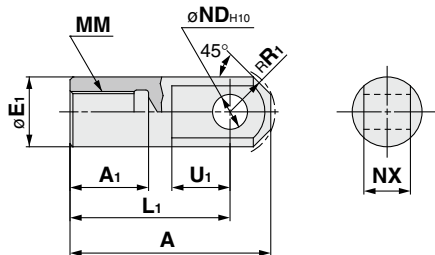

Material: Free cutting sulfur steel

[mm]

Part no.	Applicable bore size [mm]	A	A ₁	E ₁	L ₁	MM	ND _{H10}	NX	R ₁	U ₁
I-04A	40	69	22	24	55	M14 x 1.5	12 ^{+0.070} ₀	16 ^{-0.1} _{-0.3}	15.5	20
I-05A	50, 63	74	27	28	60	M18 x 1.5	12 ^{+0.070} ₀	16 ^{-0.1} _{-0.3}	15.5	20
I-08A	80	91	37	36	71	M22 x 1.5	18 ^{+0.070} ₀	28 ^{-0.1} _{-0.3}	22.5	26
I-10A	100	105	37	40	83	M26 x 1.5	20 ^{+0.084} ₀	30 ^{-0.1} _{-0.3}	24.5	28

Rod End Nut (Standard)

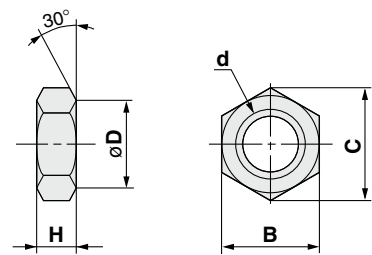

Material: Rolled steel

[mm]

Part no.	Applicable bore size [mm]	B	C	D	d	H
NT-04	40	22	25.4	21	M14 x 1.5	8
NT-05	50, 63	27	31.2	26	M18 x 1.5	11
NT-08	80	32	37.0	31	M22 x 1.5	13
NT-10	100	41	47.3	39	M26 x 1.5	16

Fine Lock Cylinder

Double Acting, Double Rod

Series CLA2W

Non-lube Type: $\varnothing 40$, $\varnothing 50$, $\varnothing 63$, $\varnothing 80$, $\varnothing 100$

How to Order

CLA2W **L** **40** - **200** **JJ** - **E** -

With auto switch **CDLA2W** **L** **40** - **200** **JJ** - **E** - **M9BW** -

With auto switch (Built-in magnet) **Double rod type**

Mounting

B	Basic
L	Axial foot
F	Rod flange
T	Center trunnion

Tube material

Nil	Aluminum tube
F*	Steel tube

* Not available with auto switch.

Bore size

40	40 mm	80	80 mm
50	50 mm	100	100 mm
63	63 mm		

Port thread type

Nil	Rc
TN	NPT

Auto switch

Nil Without auto switch
* For applicable auto switches, refer to the table below.

Lock operation

E	Spring locking (Exhaust locking)
P	Pneumatic locking (Pressure locking)
D	Spring and pneumatic locking

Number of auto switches

Nil	2 pcs.
S	1 pc.
n	"n" pcs.

Made to Order
For details, refer to page 13.

With rod boot/cushion**

Rod boot	One side*	Nil	Without rod boot	Cushion	Nil	With cushion on both sides
		J	Nylon tarpaulin		N	Without cushion
	Both sides	K	Heat resistant tarpaulin			
		JJ	Nylon tarpaulin			
		KK	Heat resistant tarpaulin			

* In case of one side, it is in the lock side.
** When the symbols are two or more, indicate them alphabetically.

Built-in Magnet Cylinder Model

If a built-in magnet cylinder without an auto switch is required, there is no need to enter the symbol for the auto switch.
(Example) CDLA2WL40-100-E

Cylinder stroke [mm]
For details, refer to page 13.

Applicable Auto Switches/Refer to the Best Pneumatics No. 3 for further information on auto switches.

Type	Special function	Electrical entry	Indicator light	Wiring (Output)	Load voltage		Auto switch model		Lead wire length [m]					Pre-wired connector	Applicable load					
					DC	AC	Tie-rod mounting	Band mounting	0.5 (Nil)	1 (M)	3 (L)	5 (Z)								
Solid state auto switch	—	Grommet	—	3-wire (NPN)	24 V	5 V, 12 V	—	M9N	●	●	●	○	○	IC circuit	Relay, PLC					
				3-wire (PNP)				—	●	●	●	○	○							
				2-wire	—	●	●	●	○	○										
		Terminal conduit		3-wire (NPN)	24 V	12 V	—	G39C	G39	—	—	—	—			—	—			
				2-wire				—	—	—	—	—	—							
				3-wire (NPN)	24 V	5 V, 12 V	—	M9NW	—	●	●	●	○			○	IC circuit			
	3-wire (PNP)	—	●	●				●	○	○										
	Diagnostic indication (2-color indication)	Grommet	Yes	24 V	2-wire	12 V	—	M9BW	—	●	●	●	○	○		IC circuit				
					3-wire (NPN)			—	●	●	●	○	○							
					3-wire (PNP)	—	●	●	●	○	○									
		Water resistant (2-color indication)			Grommet	No	24 V	3-wire (NPN)	5 V, 12 V	—	M9NA**	—	○	○			●	○	○	—
								3-wire (PNP)			—	○	○	●			○	○		
2-wire								12 V	—	M9PA**	—	○	○	●	○		○			
3-wire (NPN)	—	○	○	●	○					○										
With diagnostic output (2-color indication)	Grommet	Yes	24 V	2-wire	12 V			—	M9BA**	—	○	○	●	○	○	IC circuit				
				3-wire (PNP)					—	○	○	●	○	○						
Magnetic field resistant (2-color indication)	Grommet			No	24 V	3-wire (NPN equivalent)	5 V	—	A96	—	●	—	—	—	IC circuit					
						2-wire (Non-polar)			—	—	—	—	—	—						
Reed auto switch	—					Grommet	Yes	2-wire	24 V	12 V	—	A93	—	●	—	—	—	IC circuit	Relay, PLC	
												A90	—	●	—	—	—			—
		A54	B54									●	—	●	●	—				
		A64	B64									●	—	●	—	—				
		A33C	A33	—	—							—	—	—						
		A34C	A34	—	—							—	—	—						
		Terminal conduit	Grommet	Yes	24 V	12 V		100 V, 200 V	—	A44C	A44	—	—	—	—	—	PLC			
										A44C	A44	—	—	—	—					
										A59W	B59W	●	—	●	—			—		
										A59W	B59W	●	—	●	—			—		
										A59W	B59W	●	—	●	—			—		
										A59W	B59W	●	—	●	—			—		
DIN terminal	Grommet	Yes	24 V	12 V	100 V, 200 V	—	A44C	A44	—	—	—	—	—	Relay, PLC						
							A44C	A44	—	—	—	—								

** Water resistant type auto switches can be mounted on the above models, but in such case SMC cannot guarantee water resistance. Please contact SMC regarding water resistant types with the above model numbers.

* Lead wire length symbols: 0.5 m..... Nil (Example) M9NW * Solid state auto switches marked with "○" are produced upon receipt of order.
1 m..... M (Example) M9NWM
3 m..... L (Example) M9NWL
5 m..... Z (Example) M9NWX

* Since there are other applicable auto switches than listed above, refer to page 23 for details.

* For details about auto switches with pre-wired connector, refer to the Best Pneumatics No. 3. For the D-P3DWA□, refer to the **WEB catalog**.

* The D-A9□/M9□□□/P3DWA□ auto switches are shipped together, (but not assembled). (However, auto switch mounting brackets are assembled for the D-A9□/M9□□□ before shipment.)

Fine Lock Cylinder: Double Acting, Double Rod *Series CLA2W*

Provided with a compact lock mechanism, it is suitable for intermediate stop, emergency stop, and drop prevention.



Made to Order

Symbol	Specifications
-XC14	Change of trunnion bracket mounting position
-XC15	Change of tie-rod length

Caution

Recommended Pneumatic Circuit/Caution on Handling

For detailed specifications mentioned above, refer to "Specific Product Precautions 3".

Refer to pages 18 to 23 for cylinders with auto switches.

- Minimum stroke for auto switch mounting
- Auto switch proper mounting position (detection at stroke end) and its mounting height
- Operating range
- Auto switch mounting brackets/Part no.

Minimum Stroke for Auto Switch Mounting

Caution

- The minimum stroke for mounting varies with the auto switch type and cylinder mounting type. In particular, the center trunnion type needs careful attention. (For details, refer to pages 20 and 21.)

Rod Boot Material

Symbol	Rod boot material	Max. ambient temperature
J	Nylon tarpaulin	70°C
K	Heat resistant tarpaulin	110°C*

* Maximum ambient temperature for the rod boot

Specifications

Bore size [mm]	40	50	63	80	100
Action	Double acting, Double rod				
Lock operation	Spring locking, Pneumatic locking, Spring and pneumatic locking				
Type	Non-lube				
Proof pressure	1.5 MPa				
Maximum operating pressure	1.0 MPa				
Minimum operating pressure	0.1 MPa				
Piston speed	50 to 500 mm/sec*				
Ambient and fluid temperature	Without auto switch: -10°C to 70°C (No freezing) With auto switch: 10°C to 60°C				
Cushion	Air cushion				
Stroke length tolerance	Up to 250: $^{+1.0}_0$, 251 to 750: $^{+1.4}_0$				
Mounting	Basic, Axial foot, Rod flange, Center trunnion				

* Constraints associated with the allowable kinetic energy are imposed on the speeds at which the piston can be locked.

Lock Specifications

Lock operation	Spring locking (Exhaust locking)	Spring and pneumatic locking	Pneumatic locking (Pressure locking)
Unlocking pressure [MPa]	0.3 or more		0.1 or more
Lock starting pressure [MPa]	0.25 or less		0.05 or more
Maximum operating pressure [MPa]	1.0	0.5	
Locking direction	Both directions		

Accessories/For details, refer to page 11.

Mounting		Basic	Axial foot	Rod flange	Center trunnion
Standard	Rod end nut	●	●	●	●
Option	Single knuckle joint	●	●	●	●
	Double knuckle joint (with pin)	●	●	●	●
	Rod boot	●	●	●	●

* Dimensions of accessories are the same as the standard type of the CLA2 series. (Refer to page 11.)

Standard Strokes

Bore size [mm]	Standard stroke [mm]
40	25, 50, 75, 100, 125, 150, 175, 200, 250, 300, 350, 400, 450, 500
50, 63	25, 50, 75, 100, 125, 150, 175, 200, 250, 300, 350, 400, 450, 500, 600
80, 100	25, 50, 75, 100, 125, 150, 175, 200, 250, 300, 350, 400, 450, 500, 600, 700

Note) Intermediate strokes not listed above are produced upon receipt of order. Spacers are not used for intermediate strokes.

Mounting Brackets/Part No.

Bore size [mm]	40	50	63	80	100
Axial foot*	CA2-L04	CA2-L05	CA2-L06	CA2-L08	CA2-L10
Flange	CA2-F04	CA2-F05	CA2-F06	CA2-F08	CA2-F10

* When axial foot brackets are used, order two pieces per cylinder.

Weights

Bore size [mm]		40	50	63	80	100	
Basic weight	Basic	Aluminum tube	1.92	2.92	4.55	7.44	10.61
		Steel tube	1.97	2.97	4.59	7.60	10.83
	Axial foot	Aluminum tube	2.11	3.14	4.89	8.11	11.60
		Steel tube	2.16	3.19	4.93	8.27	11.82
	Flange	Aluminum tube	2.29	3.39	5.34	8.89	12.53
		Steel tube	2.34	3.42	5.38	9.06	12.75
	Center trunnion	Aluminum tube	2.37	3.45	5.44	9.14	13.01
		Steel tube	2.47	3.56	5.64	9.43	13.40
Additional weight per 50 mm of stroke	All mounting brackets	Aluminum tube	0.28	0.37	0.44	0.66	0.86
		Steel tube	0.35	0.47	0.55	0.89	1.15
Accessories	Single knuckle	0.23	0.26	0.26	0.60	0.83	
	Double knuckle (with pin)	0.37	0.43	0.43	0.87	1.27	

Calculation: (Example) **CLA2WL40-100-E** Basic weight.....2.11 (Axial foot, ø40)
 Additional weight.....0.28/50 stroke
 Cylinder stroke.....100 stroke
 $2.11 + 0.28 \times 100/50 = 2.67$ kg

Series CLA2W

⚠ Caution/Allowable Kinetic Energy when Locking

Bore size [mm]	40	50	63	80	100
Allowable kinetic energy [J]	1.42	2.21	3.53	5.69	8.83

- In terms of specific load conditions, the allowable kinetic energy indicated in the table above is equivalent to a 50% load ratio at 0.5 MPa, and a piston speed of 300 mm/s. Therefore, if the operating conditions are below these values, calculations are unnecessary.
- Apply the following formula to obtain the kinetic energy of the load.

$$E_k = \frac{1}{2} m v^2$$
 Ek: Kinetic energy of load [J]
 m: Load mass [kg]
 v: Piston speed [m/s]
- The piston speed will exceed the average speed immediately before locking. To determine the piston speed for the purpose of obtaining the kinetic energy of load, use 1.2 times the average speed as a guide.
- The relationship between the speed and the load is indicated in the diagram below. The area below the line is the allowable kinetic energy range.
- Even within a given allowable kinetic energy level, there is an upper limit to the size of the load that can be sustained. Thus, a horizontally mounted cylinder must be operated below the solid line, and a vertically mounted cylinder must be operated below the dotted line.

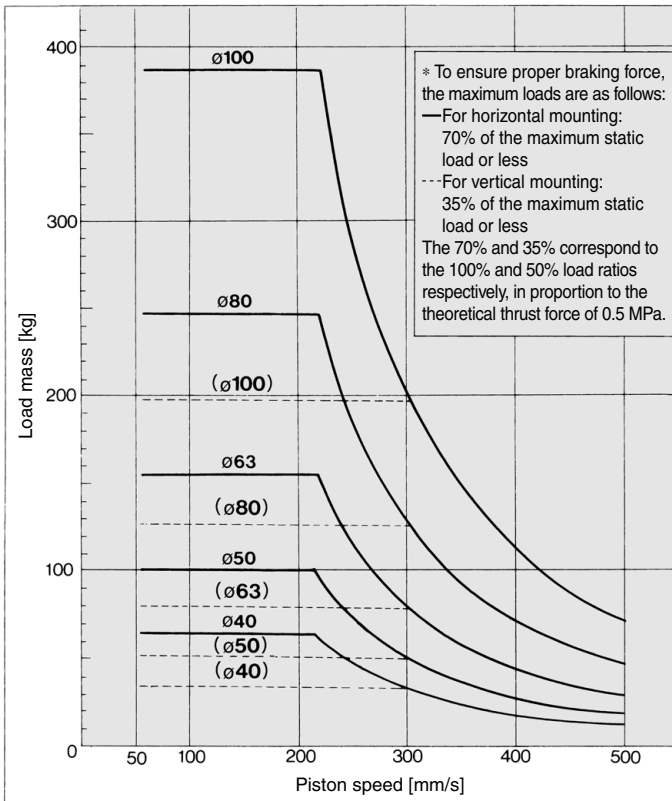

Stopping Accuracy (Not including tolerance of control system) [mm]

Locking method	Piston speed [mm/sec]			
	50	100	300	500
Spring locking	±0.4	±0.5	±1.0	±2.0
Pneumatic locking Spring and pneumatic locking	±0.2	±0.3	±0.5	±1.5

Conditions/Load: 25% of output at 0.5 MPa
 Solenoid valve: Mounted to the lock port

Holding Force of Spring Locking (Maximum static load)

Bore size [mm]	40	50	63	80	100
Holding force [N]	882	1370	2160	3430	5390

Note) Holding force at piston rod retracted side decreases approximately 15%.

Holding Force of Pneumatic Locking

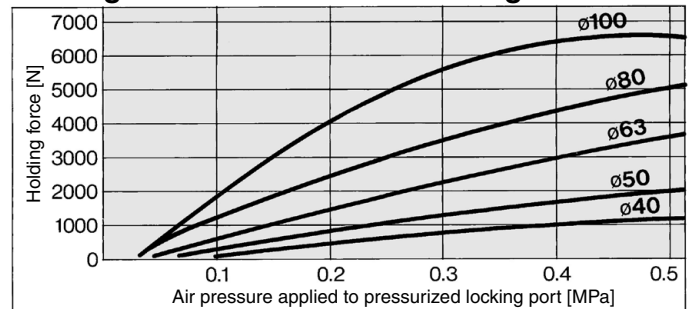

Holding Force of Spring and Pneumatic Locking

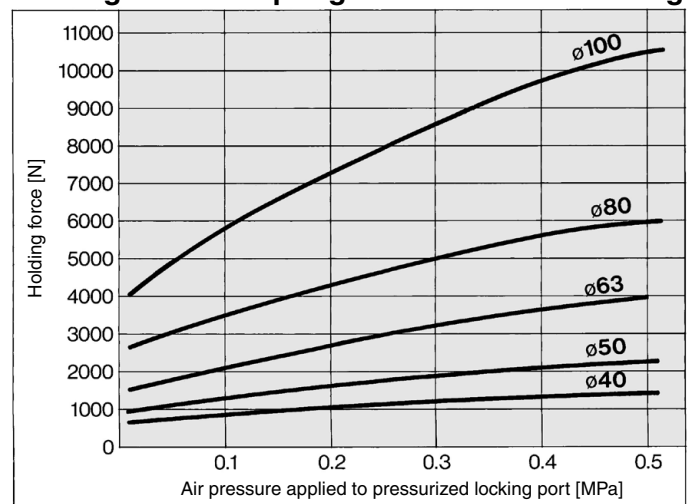

* When selecting a cylinder, refer to the Actuator Precautions on pages 3 and 4 in Best Pneumatics No. 3, Specific Product Precautions and Allowable Kinetic Energy when Locking.

⚠ Caution

Caution when Locking

Holding force (maximum static load) means the maximum capability of holding a static load that is not accompanied by vibration or impact under the condition that no load is applied. Therefore, it does not refer to a load that can be held constantly. When using (selecting) this product, carefully check the following points.

- If the piston rod slips because the lock's holding force has been exceeded, the brake shoe could be damaged, resulting in a reduced holding force or shortened life.
- The upper limit of the load that is used under the conditions not associated with the kinetic energy when locking, such as drop prevention must be 35% or less of the holding force.
- Do not use the cylinder in the locked state to sustain a load that involves impact.

Construction

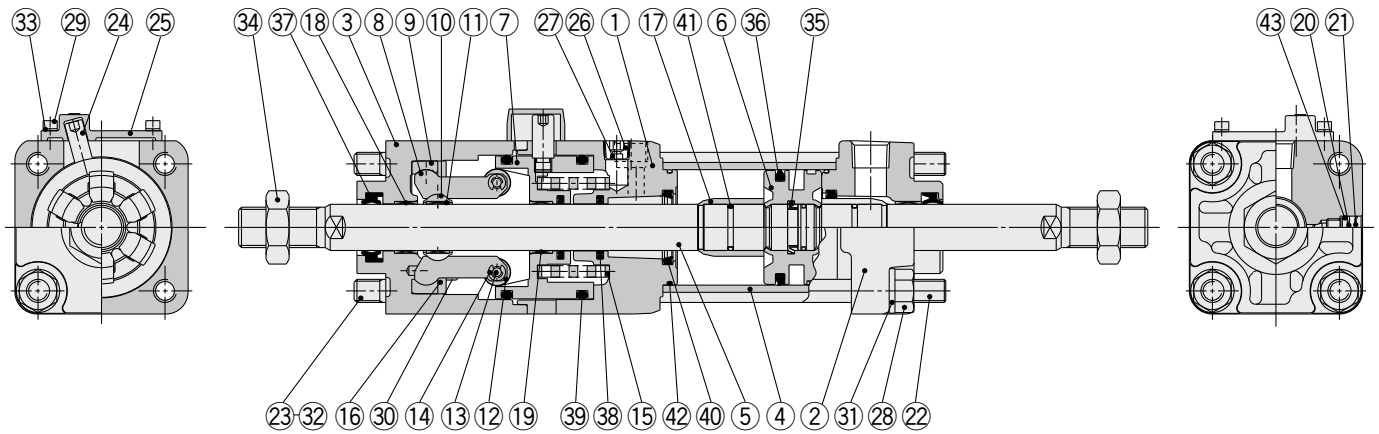

Component Parts

No.	Description	Material	Note
1	Rod cover	Aluminum alloy	Metallic painted after hard anodized
2	Rod cover	Aluminum alloy	Metallic painted
3	Cover	Aluminum alloy	Metallic painted after hard anodized
4	Cylinder tube	Aluminum alloy	Hard anodized
5	Piston rod	Carbon steel	Hard chrome plating
6	Piston	Aluminum alloy	Chromated
7	Brake piston	Carbon steel	Nitriding
8	Brake arm	Carbon steel	Nitriding
9	Arm holder	Carbon steel	Nitriding
10	Brake shoe holder	Carbon steel	Nitriding
11	Brake shoe	Special friction material	
12	Roller	Chromium molybdenum steel	Nitriding
13	Pin	Chrome bearing steel	Heat treated
14	Retaining ring	Carbon tool steel	
15	Brake spring	Steel wire	Anti-corrosive treatment: Except type P
16	Retaining plate	Rolled steel	Zinc chromated
17	Cushion ring	Aluminum alloy	Anodized
18	Bushing	Copper alloy	
19	Bushing	Copper alloy	
20	Cushion valve	Steel wire	Electroless nickel plating
21	Retaining ring	Spring steel	
22	Tie-rod	Carbon steel	Zinc chromated
23	Unit holding tie-rod	Carbon steel	Chromated
24	Non-rotating pin	Carbon steel	Heat treated
25	Pin guide	Carbon steel	Metallic painted after nitriding
26	Hexagon socket head plug	Carbon steel	Type E only
27	Element	Bronze	Type E only
28	Tie-rod nut	Rolled steel	
29	Hexagon socket head cap screw	Chromium molybdenum steel	
30	Retaining plate mounting bolt	Chromium molybdenum steel	
31	Spring washer	Steel wire	
32	Spring washer	Steel wire	
33	Spring washer	Steel wire	

No.	Description	Material	Note
34	Rod end nut	Rolled steel	
35	Piston holder	Urethane	
36	Piston seal	NBR	
37	Rod seal A	NBR	
38	Rod seal B	NBR	
39	Brake piston seal	NBR	
40	Cushion seal	Urethane	
41	Piston gasket	NBR	
42	Tube gasket	NBR	
43	Cushion valve seal	NBR	

Replacement Parts: Seal Kit

Bore size [mm]	Kit no.	Contents
40	MBW 40-PS	Set of the nos. 36, 37, 40, 42
50	MBW 50-PS	
63	MBW 63-PS	
80	MBW 80-PS	
100	MBW100-PS	

* Since the lock of the CLA2 series cannot be disassembled and is normally replaced as a unit, kits are for the cylinder section only. These can be ordered using the order number for each bore size.

* Seal kit includes a grease pack (ø40, ø50: 10 g, ø63, ø80: 20 g, ø100: 30 g). Order with the following part number when only the grease pack is needed.

Grease pack part number: GR-S-010 (10 g), GR-S-020 (20 g)

Fine Lock Cylinder: Double Acting, Double Rod *Series CLA2W*

Rod Flange: CLA2WF

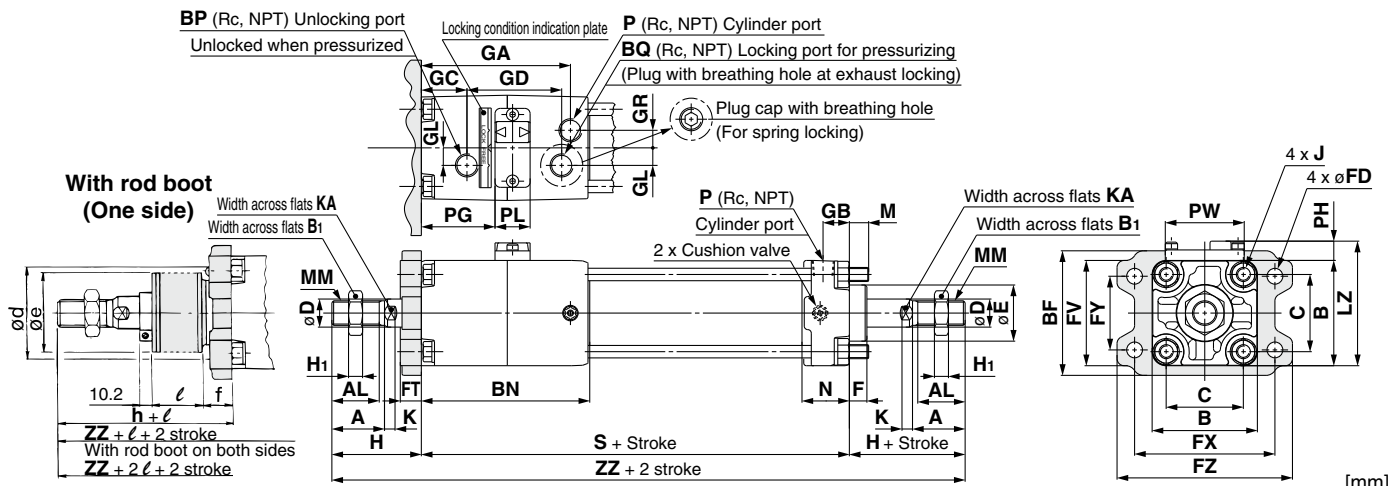

Bore size [mm]	Stroke range [mm]		A	AL	B	B ₁	BN	BP	BQ	C	D	E	FV	FD	FT	FX	FY	FZ	GA	GB	GC	GD	GL	GR	
	Without rod boot	With rod boot																							
40	Up to 500	20 to 500	30	27	60	22	71	96	1/4	1/4	44	16	32	60	9	12	80	42	100	85	15	26	54	10	10
50	Up to 600	20 to 600	35	32	70	27	81	108	1/4	1/4	52	20	40	70	9	12	90	50	110	95	17	27	59	13	12
63	Up to 600	20 to 600	35	32	86	27	101	115	1/4	1/4	64	20	40	86	11.5	15	105	59	130	102	17	26	67	18	15
80	Up to 750	20 to 750	40	37	102	32	119	129	1/4	1/4	78	25	52	102	13.5	18	130	76	160	113	21	30	72	23	17
100	Up to 750	20 to 750	40	37	116	41	133	140	1/4	1/4	92	30	52	116	13.5	18	150	92	180	124	21	31	76	25	19

Bore size [mm]	H ₁	J	K	KA	LZ	M	MM	N	P	PG	PH	PL	PW	S	Without rod boot						With rod boot (One side)						(Both sides)	
															H	ZZ	d*	e	f	h	ℓ	ZZ	ZZ	ZZ	ZZ			
40	8	M8 x 1.25	6	14	71	11	M14 x 1.5	27	1/4	42	11	20	45	153	51	51	255	52	43	15	59	1/4 stroke	263	271				
50	11	M8 x 1.25	7	18	80	11	M18 x 1.5	30	3/8	46	10	21	50	168	58	284	58	52	15	66	1/4 stroke	292	300					
63	11	M10 x 1.25	7	18	99	14	M18 x 1.5	31	3/8	48.5	13	23	60	182	58	298	58	52	17.5	66	1/4 stroke	306	314					
80	13	M12 x 1.75	10	22	117	17	M22 x 1.5	37	1/2	55	15	23	70	208	71	350	80	65	21.5	80	1/4 stroke	359	368					
100	16	M12 x 1.75	10	26	131	17	M26 x 1.5	40	1/2	56.5	15	25	80	226	72	370	80	65	21.5	81	1/4 stroke	379	388					

* When a hole must be made to accommodate the rod portion, make sure to machine a hole that is larger than the outer diameter of the boot mounting bracket ød.

Center Trunnion: CLA2WT

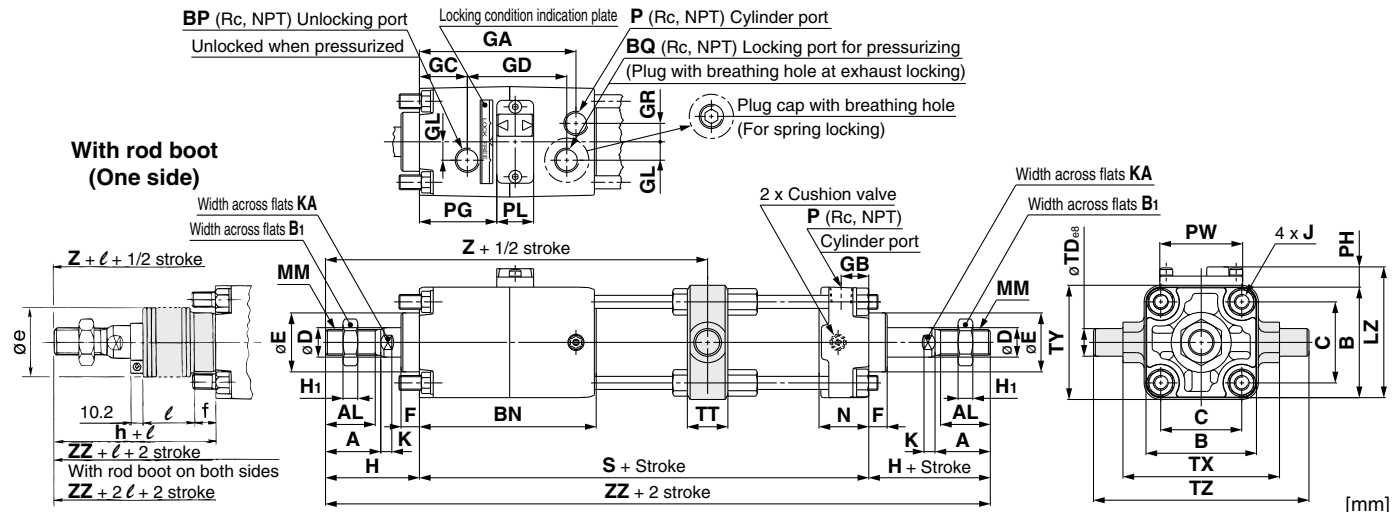

Bore size [mm]	Stroke range [mm]		A	AL	B	B ₁	BN	BP	BQ	C	D	E	F	GA	GB	GC	GD	GL	GR	H ₁	J	K	KA	LZ
	Without rod boot	With rod boot																						
40	25 to 500	25 to 500	30	27	60	22	96	1/4	1/4	44	16	32	10	85	15	26	54	10	10	8	M8 x 1.25	6	14	71
50	25 to 600	25 to 600	35	32	70	27	108	1/4	1/4	52	20	40	10	95	17	27	59	13	12	11	M8 x 1.25	7	18	80
63	32 to 600	32 to 600	35	32	86	27	115	1/4	1/4	64	20	40	10	102	17	26	67	18	15	11	M10 x 1.25	7	18	99
80	41 to 750	41 to 750	40	37	102	32	129	1/4	1/4	78	25	52	14	113	21	30	72	23	17	13	M12 x 1.75	10	22	117
100	45 to 750	45 to 750	40	37	116	41	140	1/4	1/4	92	30	52	14	124	21	31	76	25	19	16	M12 x 1.75	10	26	131

Bore size [mm]	MM	N	P	PG	PH	PL	PW	S	TD _{e8}	TT	TX	TY	TZ	Without rod boot						With rod boot (One side)						(Both sides)	
														H	Z	ZZ	e	f	h	ℓ	Z	ZZ	Z	ZZ			
40	M14 x 1.5	27	1/4	42	11	20	45	153	15 ^{-0.032} _{-0.059}	22	85	62	117	51	162	255	43	11.2	59	1/4 stroke	170	263	170	271			
50	M18 x 1.5	30	3/8	46	10	21	50	168	15 ^{-0.032} _{-0.059}	22	95	74	127	58	181	284	52	11.2	66	1/4 stroke	189	292	189	300			
63	M18 x 1.5	31	3/8	48.5	13	23	60	182	18 ^{-0.032} _{-0.059}	28	110	90	148	58	191	298	52	11.2	66	1/4 stroke	199	306	199	314			
80	M22 x 1.5	37	1/2	55	15	23	70	208	25 ^{-0.040} _{-0.073}	34	140	110	192	71	221	350	65	12.5	80	1/4 stroke	230	359	230	368			
100	M26 x 1.5	40	1/2	56.5	15	25	80	226	25 ^{-0.040} _{-0.073}	40	162	130	214	72	235	370	65	14.0	81	1/4 stroke	244	379	244	388			

Series CLA2

Auto Switch Proper Mounting Position (Detection at stroke end) and Its Mounting Height

<Band mounting>

D-B5□/B64
D-B59W

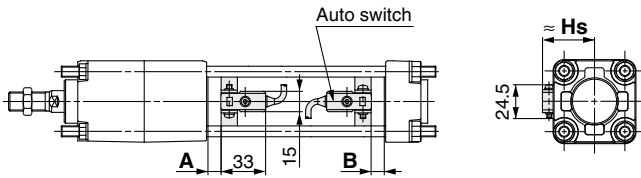

D-A3□
D-G39/K39

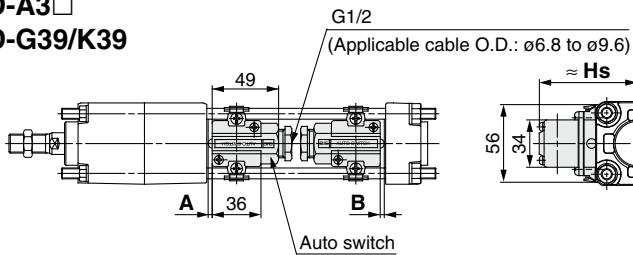

D-G5□/K59
D-G5□W/K59W
D-G5BA
D-G59F/G5NT

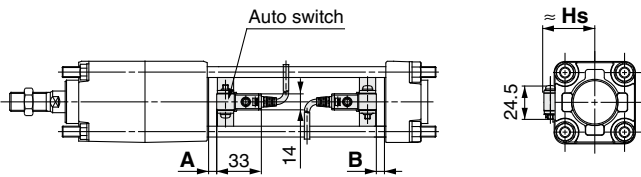

D-A44

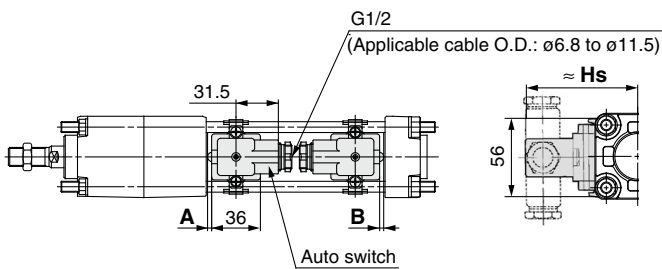

<Tie-rod mounting>

D-M9□/M9□V
D-M9□W/M9□WV
D-M9□A/M9□AV
D-A9□/A9□V
D-Z7□/Z80
D-Y59□/Y69□/Y7P/Y7PV
D-Y7□W/Y7□WV
D-Y7BA

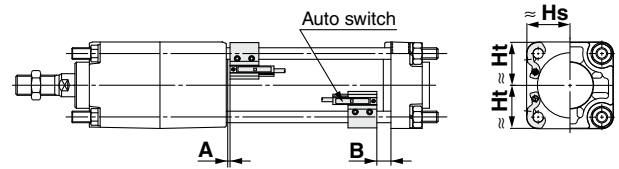

D-A5□/A6□ D-A59W

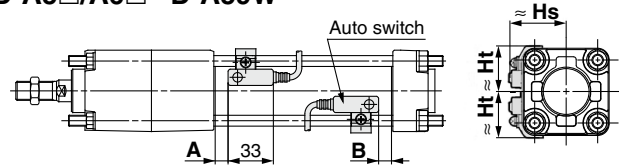

D-A3□C D-G39C/K39C

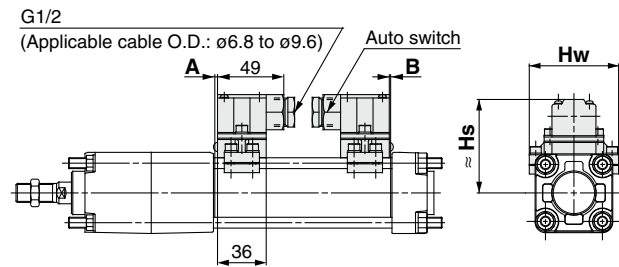

D-F5□/J59 D-F5□W/J59W
D-F5NT D-F5BA/F59F

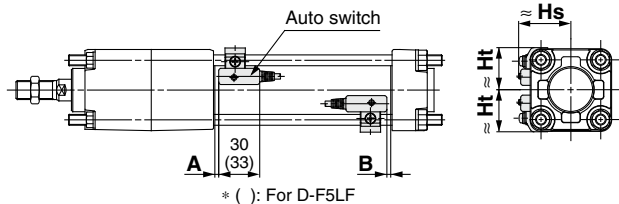

D-A44C

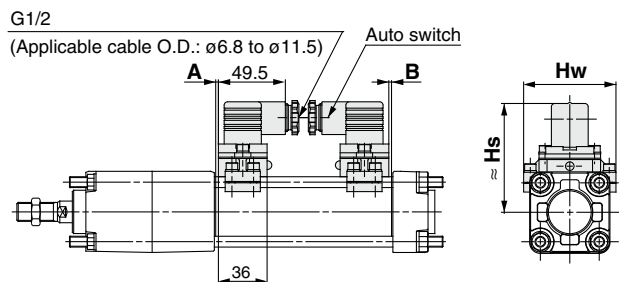

D-P3DWA

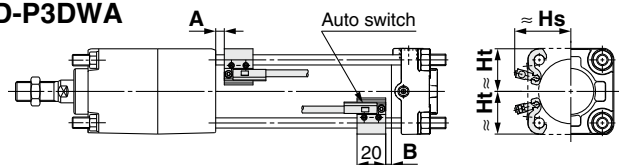

D-P4DW

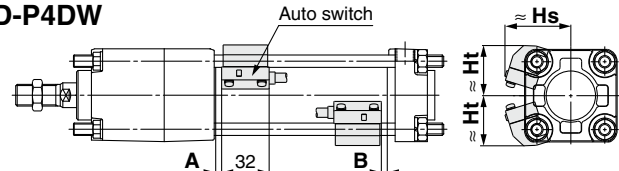

Auto Switch Proper Mounting Position (Detection at stroke end) and Its Mounting Height

Auto Switch Proper Mounting Position

[mm]

Auto switch model	D-M9□ D-M9□V D-M9□W D-M9□WV D-M9□A D-M9□AV		D-A9□ D-A9□V		D-B59W D-Z7□ D-Z80 D-Y59□ D-Y69□ D-Y7P D-Y7PV D-Y7□W D-Y7□WV D-Y7BA		D-P3DWA		D-P4DW		D-A5□ D-A6□ D-A3□ D-A3□C D-A44 D-A44C D-G39 D-G39C D-K39 D-K39C		D-B5□ D-B64		D-F5□ D-J59 D-F59F D-F5□W D-J59W D-F5BA		D-G5□ D-K59 D-G5NT D-G5□W D-K59W D-G5BA D-G59F		D-A59W		D-F5NT	
	A	B	A	B	A	B	A	B	A	B	A	B	A	B	A	B	A	B	A	B	A	B
40	10	8	6	4	4	1	5.5	3.5	3.5	0.5	0.5	0	1	0	7	4	2.5	0	4.5	1.5	12	9
50	10	8	6	4	3.5	1.5	5.5	3.5	3	1	0	0	0.5	0	6.5	4.5	2	0	4	2	11.5	9.5
63	12.5	11.5	8.5	7.5	6	5	8	7	5.5	4.5	2.5	1.5	3	2	9	8	4.5	3.5	6.5	5.5	14	13
80	16	14	12	10	9.5	7.5	11.5	9.5	9	7	6	4	6.5	4.5	12.5	10.5	8	6	10	8	17.5	15.5
100	17.5	16.5	13.5	12.5	11	10	13	12	10.5	9.5	7.5	6.5	8	7	14	13	9.5	8.5	11.5	10.5	19	18

Note) Adjust the auto switch after confirming the operating conditions in the actual setting.

Auto Switch Proper Mounting Height

[mm]

Auto switch model	D-M9□ D-M9□W D-M9□A D-A9□		D-M9□V D-M9□WV D-M9□AV		D-A9□V		D-Z7□ D-Z80 D-Y59□ D-Y7P D-Y7BA D-Y7□W		D-Y69□ D-Y7PV D-Y7□WV		D-P3DWA		D-P4DW		D-B5□ D-B64 D-B59W D-G5□ D-K59 D-G5NT D-G5□W D-K59W D-G5BA D-G59F		D-A3□ D-G39 D-K39		D-A44		D-A5□ D-A6□ D-A59W	
	Hs	Ht	Hs	Ht	Hs	Ht	Hs	Ht	Hs	Ht	Hs	Ht	Hs	Ht	Hs	Hs	Hs	Hs	Hs	Hs	Ht	
40	30	30	34	30	31	30	30	30	30	30	30	37.5	35	42.5	33	37	71.5	81.5	38.5	31.5		
50	34	34	38	34	35	34	34	34	34	34	34	41.5	39	46.5	37.5	42	76.5	86.5	42	35.5		
63	41	41	44	41	41.5	41	41	41	41	41	41	50	41	52	43	49	83.5	93.5	46.5	43		
80	49.5	49	52.5	49	50	49	49.5	49	49.5	49	49	58	49	58.5	51.5	57.5	92	102	53.5	51		
100	56.5	56	61	56	58.5	56	56.5	55.5	57.5	55.5	66	56	66	58.5	68	102.5	112.5	61.5	57.5			

Auto switch model	D-F5□ D-J59 D-F5□W D-J59W D-F5BA D-F59F D-F5NT		D-A3□C D-G39C D-K39C		D-A44C	
	Hs	Ht	Hs	Hw	Hs	Hw
40	38	31.5	73	69	81	69
50	42	35.5	78.5	77	86.5	77
63	47	43	85.5	91	93.5	91
80	53.5	51	94	107	102	107
100	61	57.5	104	121	112	121

Series CLA2

Minimum Stroke for Auto Switch Mounting

n: Number of auto switches [mm]

Auto switch model	Number of auto switches	Brackets other than center trunnion	Center trunnion				
			ø40	ø50	ø63	ø80	ø100
D-M9□ D-M9□W D-M9□A	2 (Different surfaces, same surface), 1	15	80		95	110	115
	n	$15 + 40 \frac{(n-2)}{2}$ (n = 2, 4, 6, 8...) ^{Note 1)}	$80 + 40 \frac{(n-4)}{2}$ (n = 4, 8, 12, 16...) ^{Note 2)}		$95 + 40 \frac{(n-4)}{2}$ (n = 4, 8, 12, 16...) ^{Note 2)}	$110 + 40 \frac{(n-4)}{2}$ (n = 4, 8, 12, 16...) ^{Note 2)}	$115 + 40 \frac{(n-4)}{2}$ (n = 4, 8, 12, 16...) ^{Note 2)}
D-M9□V D-M9□WV D-M9□AV	2 (Different surfaces, same surface), 1	10	80		95	110	115
	n	$10 + 30 \frac{(n-2)}{2}$ (n = 2, 4, 6, 8...) ^{Note 1)}	$80 + 30 \frac{(n-4)}{2}$ (n = 4, 8, 12, 16...) ^{Note 2)}		$95 + 30 \frac{(n-4)}{2}$ (n = 4, 8, 12, 16...) ^{Note 2)}	$110 + 30 \frac{(n-4)}{2}$ (n = 4, 8, 12, 16...) ^{Note 2)}	$115 + 30 \frac{(n-4)}{2}$ (n = 4, 8, 12, 16...) ^{Note 2)}
D-A9□	2 (Different surfaces, same surface), 1	15	75		90	100	110
	n	$15 + 40 \frac{(n-2)}{2}$ (n = 2, 4, 6, 8...) ^{Note 1)}	$75 + 40 \frac{(n-4)}{2}$ (n = 4, 8, 12, 16...) ^{Note 2)}		$90 + 40 \frac{(n-4)}{2}$ (n = 4, 8, 12, 16...) ^{Note 2)}	$100 + 40 \frac{(n-4)}{2}$ (n = 4, 8, 12, 16...) ^{Note 2)}	$110 + 40 \frac{(n-4)}{2}$ (n = 4, 8, 12, 16...) ^{Note 2)}
D-A9□V	2 (Different surfaces, same surface), 1	10	75		90	100	110
	n	$10 + 30 \frac{(n-2)}{2}$ (n = 2, 4, 6, 8...) ^{Note 1)}	$75 + 30 \frac{(n-4)}{2}$ (n = 4, 8, 12, 16...) ^{Note 2)}		$90 + 30 \frac{(n-4)}{2}$ (n = 4, 8, 12, 16...) ^{Note 2)}	$100 + 30 \frac{(n-4)}{2}$ (n = 4, 8, 12, 16...) ^{Note 2)}	$110 + 30 \frac{(n-4)}{2}$ (n = 4, 8, 12, 16...) ^{Note 2)}
D-A5□/A6□ D-F5□/J59 D-F5□W/J59W D-F5BA/F59F	2 (Different surfaces, same surface), 1	15	90		100	110	120
	n (Same surface)	$15 + 55 \frac{(n-2)}{2}$ (n = 2, 4, 6, 8...) ^{Note 1)}	$90 + 55 \frac{(n-4)}{2}$ (n = 4, 8, 12, 16...) ^{Note 2)}		$100 + 55 \frac{(n-4)}{2}$ (n = 4, 8, 12, 16...) ^{Note 2)}	$110 + 55 \frac{(n-4)}{2}$ (n = 4, 8, 12, 16...) ^{Note 2)}	$120 + 55 \frac{(n-4)}{2}$ (n = 4, 8, 12, 16...) ^{Note 2)}
D-A59W	2 (Different surfaces, same surface)	20	90		100	110	120
	n (Same surface)	$20 + 55 \frac{(n-2)}{2}$ (n = 2, 4, 6, 8...) ^{Note 1)}	$90 + 55 \frac{(n-4)}{2}$ (n = 4, 8, 12, 16...) ^{Note 2)}		$100 + 55 \frac{(n-4)}{2}$ (n = 4, 8, 12, 16...) ^{Note 2)}	$110 + 55 \frac{(n-4)}{2}$ (n = 4, 8, 12, 16...) ^{Note 2)}	$120 + 55 \frac{(n-4)}{2}$ (n = 4, 8, 12, 16...) ^{Note 2)}
	1	15	90		100	110	120
D-F5NT	2 (Different surfaces, same surface), 1	25	110		120	130	140
	n (Same surface)	$25 + 55 \frac{(n-2)}{2}$ (n = 2, 4, 6, 8...) ^{Note 1)}	$110 + 55 \frac{(n-4)}{2}$ (n = 4, 8, 12, 16...) ^{Note 2)}		$120 + 55 \frac{(n-4)}{2}$ (n = 4, 8, 12, 16...) ^{Note 2)}	$130 + 55 \frac{(n-4)}{2}$ (n = 4, 8, 12, 16...) ^{Note 2)}	$140 + 55 \frac{(n-4)}{2}$ (n = 4, 8, 12, 16...) ^{Note 2)}
D-B5□/B64 D-G5□/K59 D-G5□W D-K59W D-G5BA D-G59F D-G5NT	2	Different surfaces	15	90	100	110	110
		Same surface	75				
	n	Different surfaces	$15 + 50 \frac{(n-2)}{2}$ (n = 2, 4, 6, 8, ...) ^{Note 1)}	$90 + 50 \frac{(n-4)}{2}$ (n = 4, 8, 12, 16, ...) ^{Note 2)}	$100 + 50 \frac{(n-4)}{2}$ (n = 4, 8, 12, 16, ...) ^{Note 2)}	$110 + 50 \frac{(n-4)}{2}$ (n = 4, 8, 12, 16, ...) ^{Note 2)}	$110 + 50 \frac{(n-4)}{2}$ (n = 4, 8, 12, 16, ...) ^{Note 2)}
		Same surface	$75 + 50 (n-2)$ (n = 2, 3, 4, ...)	$90 + 50 (n-2)$ (n = 2, 4, 6, 8, ...) ^{Note 1)}	$100 + 50 (n-2)$ (n = 2, 4, 6, 8, ...) ^{Note 1)}	$110 + 50 (n-2)$ (n = 2, 4, 6, 8, ...) ^{Note 1)}	$110 + 50 (n-2)$ (n = 2, 4, 6, 8, ...) ^{Note 1)}
	1	10	90	100	110	110	
D-B59W	2	Different surfaces	20	90	100	110	110
		Same surface	75				
	n	Different surfaces	$20 + 50 \frac{(n-2)}{2}$ (n = 2, 4, 6, 8, ...) ^{Note 1)}	$90 + 50 \frac{(n-4)}{2}$ (n = 4, 8, 12, 16, ...) ^{Note 2)}	$100 + 50 \frac{(n-4)}{2}$ (n = 4, 8, 12, 16, ...) ^{Note 2)}	$110 + 50 \frac{(n-4)}{2}$ (n = 4, 8, 12, 16, ...) ^{Note 2)}	$110 + 50 \frac{(n-4)}{2}$ (n = 4, 8, 12, 16, ...) ^{Note 2)}
		Same surface	$75 + 50 (n-2)$ (n = 2, 3, 4, ...)	$90 + 50 (n-2)$ (n = 2, 4, 6, 8, ...) ^{Note 1)}	$100 + 50 (n-2)$ (n = 2, 4, 6, 8, ...) ^{Note 1)}	$110 + 50 (n-2)$ (n = 2, 4, 6, 8, ...) ^{Note 1)}	$110 + 50 (n-2)$ (n = 2, 4, 6, 8, ...) ^{Note 1)}
1	15	90	100	110	110		
D-A3□ D-G39 D-K39	2	Different surfaces	35	100	100	110	110
		Same surface	100				
	n	Different surfaces	$35 + 30 (n-2)$ (n = 2, 3, 4, ...)	$100 + 30 (n-2)$ (n = 2, 4, 6, 8, ...) ^{Note 1)}	$100 + 30 (n-2)$ (n = 2, 4, 6, 8, ...) ^{Note 1)}	$110 + 30 (n-2)$ (n = 2, 4, 6, 8, ...) ^{Note 1)}	$110 + 30 (n-2)$ (n = 2, 4, 6, 8, ...) ^{Note 1)}
		Same surface	$100 + 100 (n-2)$ (n = 2, 3, 4, ...)	$100 + 100 (n-2)$ (n = 2, 4, 6, 8, ...) ^{Note 1)}	$100 + 100 (n-2)$ (n = 2, 4, 6, 8, ...) ^{Note 1)}	$110 + 100 (n-2)$ (n = 2, 4, 6, 8, ...) ^{Note 1)}	$110 + 100 (n-2)$ (n = 2, 4, 6, 8, ...) ^{Note 1)}
1	10	100	100	110	110		
D-A44	2	Different surfaces	35	100	100	110	110
		Same surface	55				
	n	Different surfaces	$35 + 30 (n-2)$ (n = 2, 3, 4, ...)	$100 + 30 (n-2)$ (n = 2, 4, 6, 8, ...) ^{Note 1)}	$100 + 30 (n-2)$ (n = 2, 4, 6, 8, ...) ^{Note 1)}	$110 + 30 (n-2)$ (n = 2, 4, 6, 8, ...) ^{Note 1)}	$110 + 30 (n-2)$ (n = 2, 4, 6, 8, ...) ^{Note 1)}
		Same surface	$55 + 50 (n-2)$ (n = 2, 3, 4, ...)	$100 + 50 (n-2)$ (n = 2, 4, 6, 8, ...) ^{Note 1)}	$100 + 50 (n-2)$ (n = 2, 4, 6, 8, ...) ^{Note 1)}	$110 + 50 (n-2)$ (n = 2, 4, 6, 8, ...) ^{Note 1)}	$110 + 50 (n-2)$ (n = 2, 4, 6, 8, ...) ^{Note 1)}
1	10	100	100	110	110		

Note 1) When "n" is an odd number, an even number that is one larger than this odd number is used for the calculation.

Note 2) When "n" is an odd number, a multiple of 4 that is larger than this odd number is used for the calculation.

Minimum Stroke for Auto Switch Mounting

n: Number of auto switches [mm]

Auto switch model	Number of auto switches	Brackets other than center trunnion	Center trunnion					
			ø40	ø50	ø63	ø80	ø100	
D-A3□C D-G39C D-K39C	2	Different surfaces	20		100	100	120	
		Same surface	100					
	n	Different surfaces	$20 + 35(n - 2)$ (n = 2, 3, 4, ...)	$100 + 35(n - 2)$ (n = 2, 4, 6, 8, ...) Note 1)		$100 + 35(n - 2)$ (n = 2, 4, 6, 8, ...) Note 1)	$120 + 35(n - 2)$ (n = 2, 4, 6, 8, ...) Note 1)	
		Same surface	$100 + 100(n - 2)$ (n = 2, 3, 4, 5...)	$100 + 100(n - 2)$ (n = 2, 4, 6, 8, ...) Note 1)		$100 + 100(n - 2)$ (n = 2, 4, 6, 8, ...) Note 1)	$120 + 100(n - 2)$ (n = 2, 4, 6, 8, ...) Note 1)	
	1	10	100		100	120		
D-A44C	2	Different surfaces	20		100	100	120	
		Same surface	55					
	n	Different surfaces	$20 + 35(n - 2)$ (n = 2, 3, 4, ...)	$100 + 35(n - 2)$ (n = 2, 4, 6, 8, ...) Note 1)		$100 + 35(n - 2)$ (n = 2, 4, 6, 8, ...) Note 1)	$120 + 35(n - 2)$ (n = 2, 4, 6, 8, ...) Note 1)	
		Same surface	$55 + 50(n - 2)$ (n = 2, 3, 4, ...)	$100 + 50(n - 2)$ (n = 2, 4, 6, 8, ...) Note 1)		$100 + 50(n - 2)$ (n = 2, 4, 6, 8, ...) Note 1)	$120 + 50(n - 2)$ (n = 2, 4, 6, 8, ...) Note 1)	
	1	10	100		100	120		
D-Z7□/Z80 D-Y59□/Y7P D-Y7□W	2 (Different surfaces, same surface), 1	15	80	85	90	95	105	
	n	$15 + 40 \frac{(n - 2)}{2}$ (n = 2, 4, 6, 8...) Note 1)	$80 + 40 \frac{(n - 4)}{2}$ (n = 4, 8, 12, 16...) Note 2)	$85 + 40 \frac{(n - 4)}{2}$ (n = 4, 8, 12, 16...) Note 2)	$90 + 40 \frac{(n - 4)}{2}$ (n = 4, 8, 12, 16...) Note 2)	$95 + 40 \frac{(n - 4)}{2}$ (n = 4, 8, 12, 16...) Note 2)	$105 + 40 \frac{(n - 4)}{2}$ (n = 4, 8, 12, 16...) Note 2)	
D-Y69□/Y7PV D-Y7□WV	2 (Different surfaces, same surface), 1	10	65		75	80	90	
	n	$10 + 30 \frac{(n - 2)}{2}$ (n = 2, 4, 6, 8...) Note 1)	$65 + 30 \frac{(n - 4)}{2}$ (n = 4, 8, 12, 16...) Note 2)		$75 + 30 \frac{(n - 4)}{2}$ (n = 4, 8, 12, 16...) Note 2)	$80 + 30 \frac{(n - 4)}{2}$ (n = 4, 8, 12, 16...) Note 2)	$90 + 30 \frac{(n - 4)}{2}$ (n = 4, 8, 12, 16...) Note 2)	
D-Y7BA	2 (Different surfaces, same surface), 1	20	95		100	105	110	
	n	$20 + 45 \frac{(n - 2)}{2}$ (n = 2, 4, 6, 8...) Note 1)	$95 + 45 \frac{(n - 4)}{2}$ (n = 4, 8, 12, 16...) Note 2)		$100 + 45 \frac{(n - 4)}{2}$ (n = 4, 8, 12, 16...) Note 2)	$105 + 45 \frac{(n - 4)}{2}$ (n = 4, 8, 12, 16...) Note 2)	$110 + 45 \frac{(n - 4)}{2}$ (n = 4, 8, 12, 16...) Note 2)	
D-P3DWA	2 (Different surfaces, same surface), 1	15	85			95	100	
	n	$15 + 50 \frac{(n - 2)}{2}$ (n = 2, 4, 6, 8...) Note 1)	$85 + 50 \frac{(n - 4)}{2}$ (n = 4, 8, 12, 16...) Note 2)			$95 + 50 \frac{(n - 4)}{2}$ (n = 4, 8, 12, 16...) Note 2)	$100 + 50 \frac{(n - 4)}{2}$ (n = 4, 8, 12, 16...) Note 2)	
D-P4DW	2 (Different surfaces, same surface), 1	15	120		130	140		
	n	$15 + 65 \frac{(n - 2)}{2}$ (n = 2, 4, 6, 8...) Note 1)	$120 + 65 \frac{(n - 4)}{2}$ (n = 4, 8, 12, 16...) Note 2)		$130 + 65 \frac{(n - 4)}{2}$ (n = 4, 8, 12, 16...) Note 2)	$140 + 65 \frac{(n - 4)}{2}$ (n = 4, 8, 12, 16...) Note 2)		

Note 1) When "n" is an odd number, an even number that is one larger than this odd number is used for the calculation.

Note 2) When "n" is an odd number, a multiple of 4 that is larger than this odd number is used for the calculation.

Series CLA2

Operating Range

Auto switch model	Bore size				
	40	50	63	80	100
D-M9□/M9□V D-M9□W/M9□WV D-M9□A/M9□AV	4.5	5	5.5	5	6
D-A9□/A9□V	7.5	8.5	9.5	9.5	10.5
D-Z7□/Z80	8.5	7.5	9.5	9.5	10.5
D-A3□/A44 D-A3□C/A44C	9	10	11	11	11
D-A5□/A6□					
D-B5□/B64					
D-A59W	13	13	14	14	15
D-B59W	14	14	17	16	18
D-Y59□/Y69□ D-Y7P/Y7□V D-Y7□W/Y7□WV D-Y7BA	8	7	5.5	6.5	6.5

Auto switch model	Bore size				
	40	50	63	80	100
D-F5□/J59/F59F D-F5□W/J59W D-F5BA/F5NT	4	4	4.5	4.5	4.5
D-G5□/K59/G59F D-G5□W/K59W D-G5NT/G5BA	5	6	6.5	6.5	7
D-G5NB	35	35	40	40	40
D-G39/K39 D-G39C/K39C	9	9	10	10	11
D-P3DWA	4.5	4.5	5.5	5.5	5.5
D-P4DW	4	4	4.5	4	4.5

[mm]

* Values which include hysteresis are for guideline purposes only, they are not a guarantee (assuming approximately ±30% dispersion) and may change substantially depending on the ambient environment.

Auto Switch Mounting Brackets/Part No.

<Tie-rod mounting>

Auto switch model	Bore size [mm]				
	ø40	ø50	ø63	ø80	ø100
D-M9□/M9□V D-M9□W/M9□WV D-M9□A/M9□AV D-A9□/A9□V	BA7-040	BA7-040	BA7-063	BA7-080	BA7-080
D-A5□/A6□/A59W D-F5□/J59/F5□W/J59W D-F5NT/F5BA/F59F	BT-04	BT-04	BT-06	BT-08	BT-08
D-A3□C/A44C/G39C/K39C	BA3-040	BA3-050	BA3-063	BA3-080	BA3-100
D-Z7□/Z80 D-Y59□/Y69□ D-Y7P/Y7PV D-Y7□W/Y7□WV D-Y7BA	BA4-040	BA4-040	BA4-063	BA4-080	BA4-080
D-P3DWA	BK7-040S	BK7-040S	BA10-063S	BA10-080S	BA10-080S
D-P4DW	BAP2-040	BAP2-040	BAP2-063	BAP2-080	BAP2-080

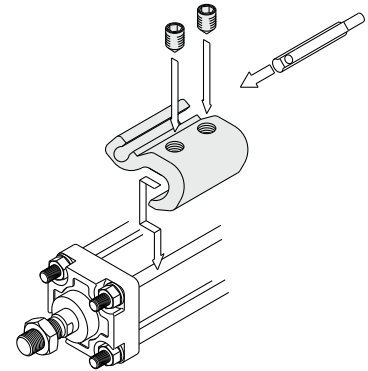

• The figure shows the mounting example for the D-A9□(V)/M9□(V)/M9□W(V)/M9□A(V) types.

<Band mounting>

Auto switch model	Bore size [mm]				
	40	50	63	80	100
D-A3□/A44 D-G39/K39	BDS-04M	BDS-05M	BMB1-063	BMB1-080	BMB1-100
D-B5□/B64 D-B59W D-G5□/K59 D-G5□W/K59W D-G59F D-G5NT D-G5NB	BH2-040	BA5-050	BAF-06	BAF-08	BAF-10

* Auto switch brackets are included in the D-A3□C/A44C/G39C/K39C types. Specify the part number as follows depending on the cylinder size when ordering.

(Example) ø40: D-A3□C-4, ø50: D-A3□C-5
ø63: D-A3□C-6, ø80: D-A3□C-8, ø100: D-A3□C-10

To order the auto switch mounting bracket separately, use the part number as shown above.

[Stainless Steel Mounting Screw]

The following stainless steel mounting screw kit (including set screws) is also available. Use it in accordance with the operating environment.

(Since the mounting bracket and band are not included, order them separately.)

BBA1: D-A5/A6/F5/J5 types
BBA3: D-B5/B6/G5/K5 types

The above stainless steel screws are used when a cylinder is shipped with D-F5BA or G5BA auto switches. When only an auto switch is shipped independently, the BBA1 or BBA3 is attached.

Note 1) Refer to the Best Pneumatics No. 2 for details on the BBA1 and BBA3.

Note 2) When using the D-M9□A, D-M9□AV or Y7BA, do not use the steel set screws which are included with the above auto switch mounting brackets (BA7-□□□, BA4-□□□). Order a stainless steel screw kit (BBA1) separately, and use the M4 x 6 L stainless steel set screws included in the BBA1.

Other than the applicable auto switches listed in “How to Order”, the following auto switches are mountable. Refer to the Best Pneumatics No. 3 for the detailed specifications.

Type	Model	Electrical entry	Features
Reed	D-A93V, A96V	Grommet (Perpendicular)	—
	D-A90V		Without indicator light
	D-A53, A56, B53, Z73, Z76	Grommet (In-line)	—
	D-A67, Z80		Without indicator light
Solid state	D-M9NV, M9PV, M9BV	Grommet (Perpendicular)	—
	D-Y69A, Y69B, Y7PV		—
	D-M9NWV, M9PWV, M9BWV		Diagnostic indication (2-color indication)
	D-Y7NWV, Y7PWV, Y7BWV		—
	D-M9NAV, M9PAV, M9BAV		Water resistant (2-color indication)
	D-Y59A, Y59B, Y7P	Grommet (In-line)	—
	D-F59, F5P, J59		—
	D-Y7NW, Y7PW, Y7BW		Diagnostic indication (2-color indication)
	D-F59W, F5PW, J59W		—
	D-F5BA, Y7BA		Water resistant (2-color indication)
	D-F5NT, G5NT		With timer
	D-P4DW, P5DW		Magnetic field resistant (2-color indication)

* With pre-wired connector is also available for solid state auto switches. For details, refer to the Best Pneumatics No. 3.

* Normally closed (NC = b contact) solid state auto switches (D-M9□E(V)/Y7G/Y7H) are also available. For details, refer to the Best Pneumatics No. 3.

Safety Instructions

These safety instructions are intended to prevent hazardous situations and/or equipment damage. These instructions indicate the level of potential hazard with the labels of “**Caution**,” “**Warning**” or “**Danger**.” They are all important notes for safety and must be followed in addition to International Standards (ISO/IEC)*1), and other safety regulations.

 **Caution:** **Caution** indicates a hazard with a low level of risk which, if not avoided, could result in minor or moderate injury.

 **Warning:** **Warning** indicates a hazard with a medium level of risk which, if not avoided, could result in death or serious injury.

 **Danger:** **Danger** indicates a hazard with a high level of risk which, if not avoided, will result in death or serious injury.

*1) ISO 4414: Pneumatic fluid power – General rules relating to systems.
ISO 4413: Hydraulic fluid power – General rules relating to systems.
IEC 60204-1: Safety of machinery – Electrical equipment of machines.
(Part 1: General requirements)
ISO 10218-1: Manipulating industrial robots – Safety.
etc.

Warning

1. The compatibility of the product is the responsibility of the person who designs the equipment or decides its specifications.

Since the product specified here is used under various operating conditions, its compatibility with specific equipment must be decided by the person who designs the equipment or decides its specifications based on necessary analysis and test results. The expected performance and safety assurance of the equipment will be the responsibility of the person who has determined its compatibility with the product. This person should also continuously review all specifications of the product referring to its latest catalog information, with a view to giving due consideration to any possibility of equipment failure when configuring the equipment.

2. Only personnel with appropriate training should operate machinery and equipment.

The product specified here may become unsafe if handled incorrectly. The assembly, operation and maintenance of machines or equipment including our products must be performed by an operator who is appropriately trained and experienced.

3. Do not service or attempt to remove product and machinery/equipment until safety is confirmed.

1. The inspection and maintenance of machinery/equipment should only be performed after measures to prevent falling or runaway of the driven objects have been confirmed.
2. When the product is to be removed, confirm that the safety measures as mentioned above are implemented and the power from any appropriate source is cut, and read and understand the specific product precautions of all relevant products carefully.
3. Before machinery/equipment is restarted, take measures to prevent unexpected operation and malfunction.

4. Contact SMC beforehand and take special consideration of safety measures if the product is to be used in any of the following conditions.

1. Conditions and environments outside of the given specifications, or use outdoors or in a place exposed to direct sunlight.
2. Installation on equipment in conjunction with atomic energy, railways, air navigation, space, shipping, vehicles, military, medical treatment, combustion and recreation, or equipment in contact with food and beverages, emergency stop circuits, clutch and brake circuits in press applications, safety equipment or other applications unsuitable for the standard specifications described in the product catalog.
3. An application which could have negative effects on people, property, or animals requiring special safety analysis.
4. Use in an interlock circuit, which requires the provision of double interlock for possible failure by using a mechanical protective function, and periodical checks to confirm proper operation.

Caution

1. The product is provided for use in manufacturing industries.

The product herein described is basically provided for peaceful use in manufacturing industries.
If considering using the product in other industries, consult SMC beforehand and exchange specifications or a contract if necessary.
If anything is unclear, contact your nearest sales branch.

Limited warranty and Disclaimer/ Compliance Requirements

The product used is subject to the following “Limited warranty and Disclaimer” and “Compliance Requirements”.

Read and accept them before using the product.

Limited warranty and Disclaimer

1. The warranty period of the product is 1 year in service or 1.5 years after the product is delivered, whichever is first.*2)
Also, the product may have specified durability, running distance or replacement parts. Please consult your nearest sales branch.
2. For any failure or damage reported within the warranty period which is clearly our responsibility, a replacement product or necessary parts will be provided.
This limited warranty applies only to our product independently, and not to any other damage incurred due to the failure of the product.
3. Prior to using SMC products, please read and understand the warranty terms and disclaimers noted in the specified catalog for the particular products.

*2) Vacuum pads are excluded from this 1 year warranty.

A vacuum pad is a consumable part, so it is warranted for a year after it is delivered.
Also, even within the warranty period, the wear of a product due to the use of the vacuum pad or failure due to the deterioration of rubber material are not covered by the limited warranty.

Compliance Requirements

1. The use of SMC products with production equipment for the manufacture of weapons of mass destruction (WMD) or any other weapon is strictly prohibited.
2. The exports of SMC products or technology from one country to another are governed by the relevant security laws and regulations of the countries involved in the transaction. Prior to the shipment of a SMC product to another country, assure that all local rules governing that export are known and followed.

Caution

SMC products are not intended for use as instruments for legal metrology.

Measurement instruments that SMC manufactures or sells have not been qualified by type approval tests relevant to the metrology (measurement) laws of each country. Therefore, SMC products cannot be used for business or certification ordained by the metrology (measurement) laws of each country.

 **Safety Instructions** Be sure to read “Handling Precautions for SMC Products” (M-E03-3) before using.



Series CLA2 Specific Product Precautions 1

Be sure to read this before handling. Refer to back page 1 for Safety Instructions. For Actuator and Auto Switch Precautions, refer to "Handling Precautions for SMC Products" (M-E03-3).

Design of Equipment and Machinery

Warning

1. Construct so that the human body will not come into direct contact with driven objects or the moving parts of locking cylinders.

If there is a risk of contact, provide safety measures such as a cover or a system that uses sensors that will activate an emergency stop before contact is made.

2. Use a balance circuit in which lurching of the piston is taken into consideration.

If the lock is applied at a desired position of a stroke and compressed air is applied to only one side of the cylinder, the piston will lurch at a high speed the moment the lock is disengaged. In such a situation, there is a risk of injury to humans, or equipment damage. To prevent the piston from lurching, use a balance circuit such as the recommended pneumatic circuit (back pages 3 and 4). If an air-hydro fine lock cylinder is used, make sure to operate the lock portion through air pressure.

Selection

Warning

Refer to the following criteria for the maximum load in the locked state, and set.

1. Holding force (max. static load) refers to the highest load that can be statically held without vibrations or impact when no load is applied. Therefore, it does not refer to loads that can be held regularly.

Set while taking the max. load when in a locked state on page 4 into account.

Taking the possibility of air supply cutoff into consideration, pneumatic locks should not be used for drop prevention.

2. In a locked state, do not apply impacts, strong vibrations or rotational forces.

Do not apply impacts, strong vibrations or rotational forces from external sources, because this could damage or shorten the life of the lock unit.

3. The locking of the fine lock cylinder is directional.

Although the fine lock cylinder can be locked in both directions, be aware that the holding force at piston rod retracted side decreases approx. 15%.

Selection

Warning

4. To effect an intermediate stop, take the cylinder's stopping precision and overrun amount into consideration.

Because the lock is applied by mechanical means, the piston will not stop immediately in response to a stopping signal, but only after a time lag. This lag determines the amount of the overrun of the piston stroke. Thus, the range of the maximum and minimum amounts of the overrun is the stopping precision.

- Place the limit switch before the desired stopping position, only in the amount of the overrun.
- The limit switch must have a detection length (dog length) of the overrun amount + α .
- For SMC's auto switches, the operating range are between 4 and 40 mm. (It varies depending on a switch model.)
When the overrun amount exceeds this range, self-holding of the contact should be performed at the switch load side.

* For stopping accuracy, refer to page 4.

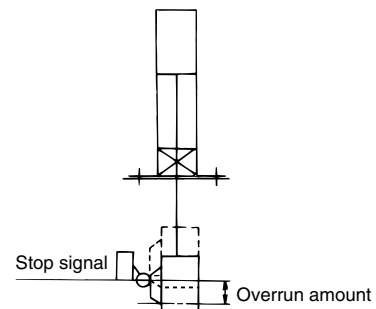

5. In order to further improve stopping accuracy, the time from the stop signal to the operation of the lock should be shortened as much as possible.

To accomplish this, use a device such as a highly responsive electric control circuit or solenoid valve driven by direct current, and place the solenoid valve as close as possible to the cylinder.

6. Be aware that the stopping accuracy is influenced by changes in the piston speed.

The variance in the stopping position increases if the piston speed changes, such as due to load fluctuations during the reciprocal movement of the piston. Therefore, take measures to ensure a constant piston speed immediately preceding the stopping position. Furthermore, the variances in the stopping position increases when the piston is effecting a cushioning stroke or during acceleration after starting its movement.

7. When unlocking is performed, if the thrust is applied to the piston, unlocking will not be easily done. To avoid that, ensure that unlocking should be performed before the thrust is applied to the piston.



Series CLA2 Specific Product Precautions 2

Be sure to read this before handling. Refer to back page 1 for Safety Instructions. For Actuator and Auto Switch Precautions, refer to "Handling Precautions for SMC Products" (M-E03-3).

Mounting

Warning

1. Be certain to connect the rod end to the load with the lock released.

- If this is performed with the lock engaged, a load that exceeds the allowable rotational force or holding force would be applied to the piston rod, which could damage the locking mechanism. The CLA2 series has a built-in manual unlocking mechanism. Therefore, it can be maintained in the unlocked state without supplying air.

Caution

1. Do not apply offset loads on the piston rod.

- Pay particular attention to aligning the center of gravity of the load with the axial center of the cylinder. If there is a large amount of deviation, the piston rod could become unevenly worn or damaged due to the inertial moment that is created when the piston rod is stopped by the lock.

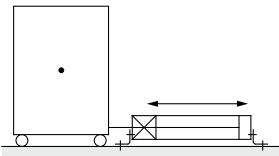

× Load center of gravity and cylinder shaft center are not matched.

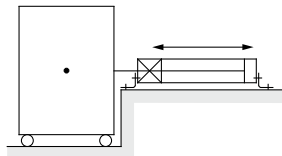

○ Load center of gravity and cylinder shaft center are matched.

Note) Can be used if all of the generated moment is absorbed by an effective guide.

2. Caution when using the basic style or replacing the mounting bracket.

The lock unit and cylinder rod cover are assembled as shown in the figure below. For this reason, it cannot be installed as in the case of common air cylinders, by using the basic style and screwing the cylinder tie-rods directly to machinery. Furthermore, when replacing mounting brackets, the unit holding tie-rods may get loosen. Tighten them once again in such a case.

Use a socket wrench for replacing the mounting bracket or tightening the unit holding tie-rod.

Bore size [mm]	Mounting bracket nut			Unit holding tie-rod	
	Nut	Width across flats	Socket	Width across flats	Socket
40, 50	JIS B1181 Class 3 M8 x 1.25	13	JIS B4636 Two-angle socket 13	10	JIS B4636 Two-angle socket 10
				13	JIS B4636 Two-angle socket 13
63	JIS B1181 Class 3 M10 x 1.25	17	JIS B4636 Two-angle socket 17	13	JIS B4636 Two-angle socket 13
80, 100	JIS B1181 Class 3 M12 x 1.75	19	JIS B4636 Two-angle socket 19	17	JIS B4636 Two-angle socket 17

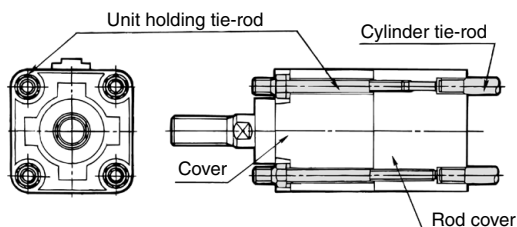

Adjustment

Caution

1. Place it in the locked position.

- The locks are manually disengaged at the time the cylinders are shipped from the factory. Therefore, make sure to change them to the locked state before using the cylinders. For procedures to effect the change, refer to back page 5. Be aware that the lock will not operate properly if the change is not performed correctly.
- Adjust the cylinder's air balance. In the state in which a load is attached to the cylinder, disengage the lock and adjust the air pressure at the rod side and the head side of the cylinder to obtain a load balance. By maintaining a proper air balance, the piston rod can be prevented from lurching when the lock is disengaged.

2. Adjust the mounting position of detections such as those of the auto switches.

To effect an intermediate stop, adjust the mounting position of the auto switch detection by taking the amount of overrun into consideration in relation to the desired stopping position.

Pneumatic Circuit

Warning

1. Be certain to use a pneumatic circuit which will apply balancing pressure to both sides of the piston when in a locked stop.

In order to prevent cylinder lurching after a lock stop, when restarting or when manually unlocking, a circuit should be used to which will apply balancing pressure to both sides of the piston, thereby canceling the force generated by the load in the direction of piston movement.

2. The effective area of the lock release solenoid valve should be at least 50% of the effective area of the cylinder driving solenoid valve, and it should be installed as close to the cylinder as possible so that it is closer than the cylinder driving solenoid valve.

If the effective area of the lock release solenoid valve is smaller than the cylinder driving solenoid valve or if it is installed at a distance from the cylinder, the time required for exhausting air for releasing the lock will be longer, which may cause a delay in the locking operation.

The delay in the locking operation may result in problems such as increase of overrunning when performing intermediate stop or emergency stop during operation, or if maintaining position from the operation stop state such as drop prevention, workpieces may be dropped depending on the timing of the load action to the operation delay of the lock.

3. Avoid backflow of the exhaust pressure when there is a possibility of interference of exhaust air, for example for a common exhaust type valve manifold.

The lock may not operate properly when the exhaust air pressure backflows due to interference of the exhaust air when exhausting air for lock release. It is recommended to use an individual exhaust type manifold or individual valves.



Series CLA2 Specific Product Precautions 3

Be sure to read this before handling. Refer to back page 1 for Safety Instructions. For Actuator and Auto Switch Precautions, refer to "Handling Precautions for SMC Products" (M-E03-3).

Pneumatic Circuit

Warning

4. Allow at least 0.5 seconds from a locked stop (intermediate stop of the cylinder) until release of the lock.

When the locked stop time is too short, the piston rod (and load) may lurch at a speed greater than the control speed of the speed controller.

5. When restarting, control the switching signal for the unlocking solenoid valve so that it acts before or at the same time as the cylinder drive solenoid valve.

If the signal is delayed, the piston rod (and load) may lurch at a speed greater than the control speed of the speed controller.

6. Carefully check for dew condensation due to repeated air supply and exhaust of the locking solenoid valve.

The operating stroke of the lock part is very small. So, if the piping is long and the air supply and exhaust are repeated, the dew condensation caused by the adiabatic expansion accumulates in the lock part. This may corrode internal parts, causing air leak or lock release fault.

7. Basic circuit

1. [Horizontal]

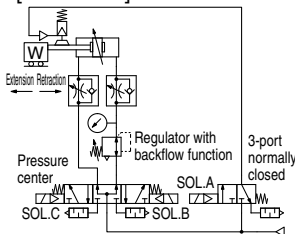

SOL.A	SOL.B	SOL.C	Action	
ON	ON	OFF	Extension	
OFF	OFF	OFF	Locked stop	0.5 s or more
ON	OFF	OFF	Unlocked	0 to 0.5 s
ON	ON	OFF	Extension	
ON	OFF	ON	Retraction	
OFF	OFF	OFF	Locked stop	0.5 s or more
ON	OFF	OFF	Unlocked	0 to 0.5 s
ON	OFF	ON	Retraction	

2. [Vertical]

[Load in the direction of rod extension]

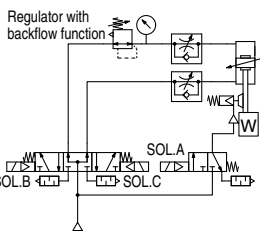

[Load in the direction of rod retraction]

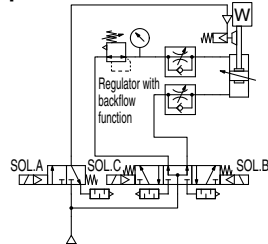

* The symbol for the cylinder with lock in the basic circuit uses SMC original symbol.

Caution

1. 3-position pressure center solenoid valve and regulator with backflow function can be replaced with two 3-port normally open valves and a regulator with relief function.

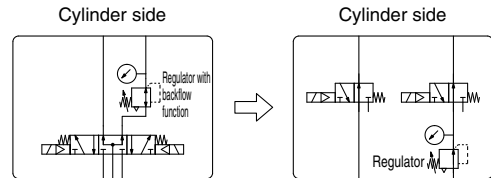

[Example]

1. [Horizontal]

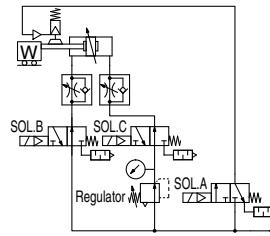

2. [Vertical]

[Load in the direction of rod extension]

[Load in the direction of rod retraction]

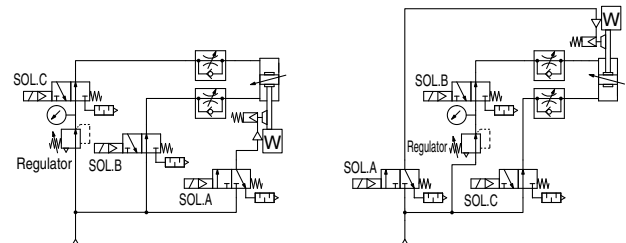

Note1) The basic circuit examples are for spring locking (exhaust locking). For pneumatic locking (pressure locking) or spring and pneumatic locking, a 5 port solenoid valve should be installed in SOL.A.

Note2) The symbol for the cylinder with lock in the pneumatic circuit uses SMC original symbol.



Series CLA2 Specific Product Precautions 4

Be sure to read this before handling. Refer to back page 1 for Safety Instructions. For Actuator and Auto Switch Precautions, refer to "Handling Precautions for SMC Products" (M-E03-3).

How to Manually Disengage the Lock and Change from the Unlocked to the Locked State

Warning The lock is manually disengaged at the time the cylinder is shipped from the factory. Because the lock will not operate in this state, make sure to change it to the locked state before operation, after having adjusted the axial center for installation.

How to Change from Unlocked to Locked State

1. Loosen the two hexagon socket head cap screws and remove the pin guide.
2. As viewed from the end of the rod, the pin is tilted 15° to the right of the center.
3. Supply an air pressure of 0.3 MPa or more to the unlocking port.
4. Rotate the pin 30° by pushing it with a wooden implement such as the grip of a wooden hammer or a resin stick.

Note) Never rotate the pin by striking it since this may bend or damage the pin. Be careful when pushing the pin since the surface is slippery.

5. Inside the pin guide, there is a slotted hole that is slightly larger than the pin. Align the pin with the slotted hole and secure them to cover, using the hexagon socket head cap screws that were removed in step 1. The convex of the pin guide and "LOCK" on the locking condition indication plate will align.

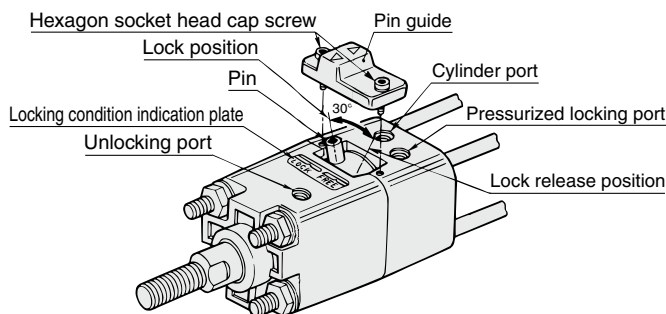

Manually Unlocking

The lock of a fine lock series cylinder can be disengaged manually through the procedure described below. However, make sure to disengage the lock pneumatically before operating the cylinder.

Note) Manual disengagement of the lock could create a greater cylinder sliding resistance than pneumatic disengagement of the lock.

1. Loosen the two hexagon socket head cap screws and remove the pin guide.
2. As viewed from the end of the rod, the pin is tilted 15° to the left of the center.
3. Supply an air pressure of 0.3 MPa or more to the unlocking port.
4. Rotate the pin 30° to the right with a wooden implement such as the grip of a wooden hammer or a resin stick without scratching.

Warning

1. Never disengage the lock manually until safety has been confirmed.

- When unlocking is performed with air pressure applied to only one side of the cylinder, the moving parts of the cylinder will lurch at high speed causing a serious hazard.
- When unlocking is performed, be sure to confirm that personnel are not within the load movement range and that no other problems will occur if the load moves.

2. Exhaust any residual pressure which is in the system.

3. Take measures to prevent the load from dropping when unlocking is performed.

- Perform work with the load in its lowest position.
- Take measures for drop prevention by strut, etc.