

Basic Pad ZP Series

p. 26

Pad diameter	ø2, ø4, ø6, ø8, ø10, ø13, ø16, ø20, ø25, ø32, ø40, ø50
Pad form	Flat type, Flat type with ribs, Bellows type, Thin flat type, Thin flat type with ribs, Deep type
Mounting	Male thread, Female thread
Vacuum inlet direction	Vertical, Lateral
Vacuum inlet	Male thread, Female thread, One-touch fitting, Barb fitting
Buffer	Without, With [Buffer stroke [mm]: 6, 10, 15, 20, 25, 30, 40, 50]
Ball joint	Without, With (Flat type only)

12 sizes, 6 types of pad forms
The mounting bracket can be selected according to the application.



Compact Type ZP3 Series

p. 132

Pad diameter	ø1.5, ø2, ø3.5, ø4, ø6, ø8, ø10, ø13, ø16
Pad form	Flat type, Flat type with groove, Bellows type, Bellows type with ribs
Mounting	Male thread, Female thread
Vacuum inlet direction	Vertical, Lateral
Vacuum inlet	Male thread, Female thread, One-touch fitting, Barb fitting
Buffer	Without, With [Buffer stroke [mm]: 3, 6, 10, 15, 20]



Overall length shortened For the flat type (Pad diameter: ø2)

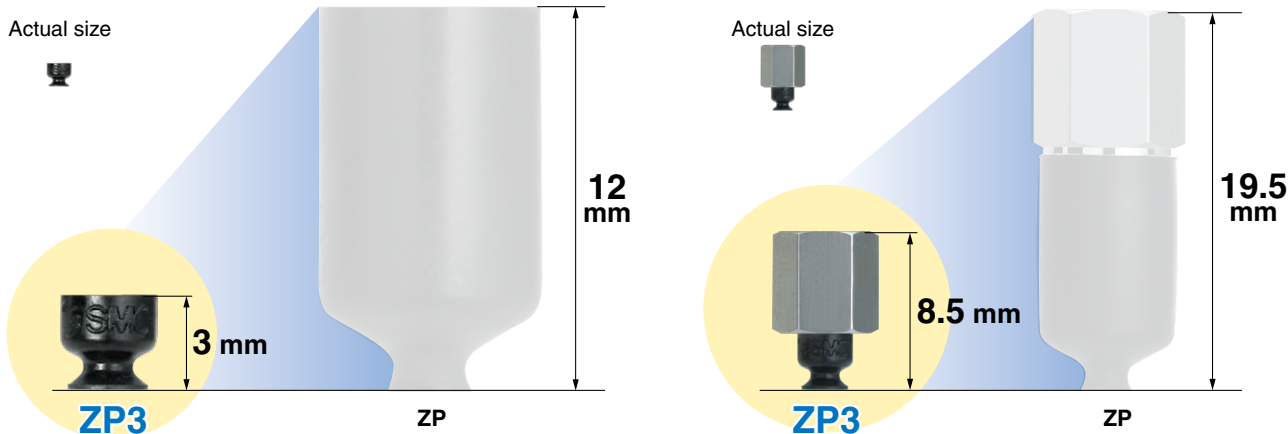

Oval Pad ZP/ZP2 Series

p. 166

Pad size	2 x 4, 3.5 x 7, 4 x 10, 4 x 20, 4 x 30, 5 x 10, 5 x 20, 5 x 30, 6 x 10, 6 x 20, 6 x 30, 8 x 20, 8 x 30
Pad form	Oval flat type
Mounting	Male thread, Female thread
Vacuum inlet direction	Vertical, Lateral
Vacuum inlet	Male thread, Female thread, One-touch fitting, Barb fitting
Buffer	Without, With [Buffer stroke [mm] ZP: 6, 10, 15, 20 ZP2: 10, 20, 30, 40, 50]

For rectangular, vertically long, and horizontally long workpieces



ZP Series

ZP2 Series

High Rigidity Pad ZP3E Series

p. 200

Pad diameter	ø32, ø40, ø50, ø63, ø80, ø100, ø125
Pad form	Flat type with groove, Bellows type with ribs and groove
Mounting	Male thread, Female thread
Vacuum inlet direction	Vertical, Lateral
Vacuum inlet	Male thread, Female thread
Buffer	Without, With [Buffer stroke [mm]: 10, 30, 50]
Ball joint	Without, With



Stable suction position, Improved ease of removal

Stable suction position

Groove and rib formed to adsorb with entire surface



Improved ease of removal

With groove

The dents and bumps on the adsorption surface prevent workpieces from sticking to the pad. This facilitates easy removal.

Shot-blasted

Micro-dents and bumps are formed on the adsorption surface. Workpieces can be removed easily.

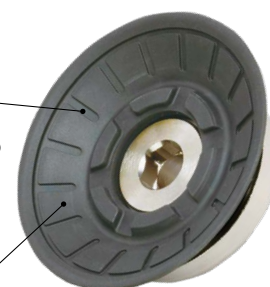

Pads for Special Applications ZP2/ZP3P Series

Mark-free Pad

For use where adsorption marks must not be left on workpieces

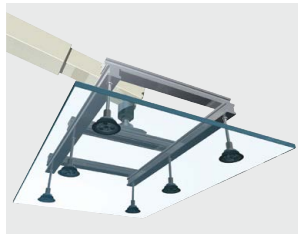

Static Neutralization

Discharge static electricity gently. Prevent damage to electronic parts.

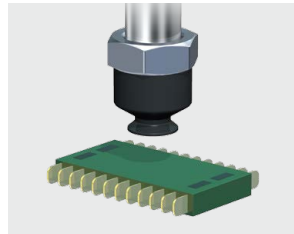

For Film Adsorption

Good for film packaging applications



Multistage

For use where there is no space for a buffer (spring type)
For workpieces with inclined adsorption surfaces

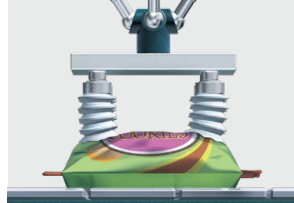

Flat Pad

For the adsorption of flexible sheets or film
Reduced deformation of flat surfaces during adsorption

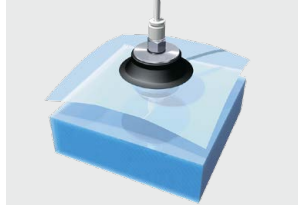

Nozzle Pad

For the adsorption of small components such as IC chips



Sponge Pad

For the adsorption of workpieces with bumps

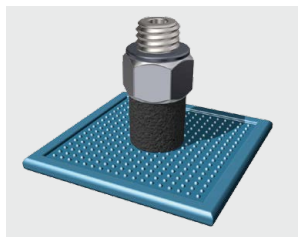

Vacuum Pad for Disk Adsorption

For the adsorption of circular components like CDs and DVDs

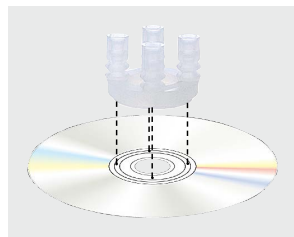

Vacuum Pad for Panel Holding

For the adsorption and holding of the stage of panels, glass circuit boards, etc.

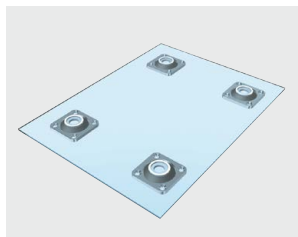

Pad with Ball Spline Buffer

The ball spline guide is used for buffers.



Compact Pad

Pad diameter: $\varnothing 3, \varnothing 4, \varnothing 5, \varnothing 6, \varnothing 7, \varnothing 8$

Pad form: Flat type, Flat type with ribs, Thin flat type, Bellows type

Compact, Space saving

Blast-type pad

Workpieces can be removed easily.



Short-type Pad

Pad diameter: $\varnothing 2, \varnothing 3, \varnothing 3.5, \varnothing 4, \varnothing 5, \varnothing 6, \varnothing 8, \varnothing 10, \varnothing 15$

Pad form: Flat type

Space saving in the height direction

Blast-type pad

Workpieces can be removed easily.



Thin Flat Pad

Pad diameter: $\varnothing 5, \varnothing 6, \varnothing 11, \varnothing 14, \varnothing 18, \varnothing 20$

For the adsorption of soft workpieces such as thin sheets or vinyl
Wrinkling or deformation during adsorption is reduced.



Bellows Pad

Pad diameter: $\varnothing 2, \varnothing 4, \varnothing 5, \varnothing 6, \varnothing 8, \varnothing 10, \varnothing 15, \varnothing 20$

For use where there is no space for a buffer (spring type)
For the adsorption of workpieces with inclined surfaces



High Rigidity Pad

Pad diameter: $\varnothing 32, \varnothing 40, \varnothing 50, \varnothing 63, \varnothing 80, \varnothing 100, \varnothing 125, \varnothing 150, \varnothing 250, \varnothing 300, \varnothing 340, 30 \times 50$

Pad form: Flat type with ribs, Thin flat type with ribs, Bellows type, Oval type



Ball joint

Non-contact Gripper

Assists in non-contact workpiece transfer

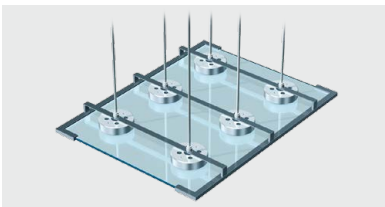

Vacuum Saving Valve

Can restrict the reduction of vacuum pressure even when there is no workpiece



Magnet Gripper

Steel plates can be transferred without vacuum.

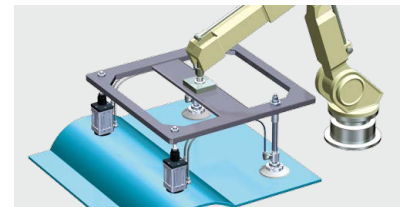

Pad Form/Pad Diameter Variations List

Vacuum Pad ZP Series Variations ▶ p. 27

Pad form	Symbol	Pad diameter [mm]												Page						
		ø1.5	ø2	ø3.5	ø4	ø6	ø8	ø10	ø13	ø16	ø20	ø25	ø32	ø40	ø50	Dimensions/Models	Construction	Mounting bracket assembly		
Flat	—	U		●		●	●	●	●	●	●	●	●	●	●	●	●	From p. 32	From p. 115	From p. 121
	With ribs	C							●	●	●	●	●	●	●	●	●	From p. 51	From p. 117	From p. 121
	Ball joint	F							●	●	●	●	●	●	●	●	●	From p. 62	From p. 119	From p. 127
Bellows	—	B				●	●	●	●	●	●	●	●	●	●	●	●	From p. 68	From p. 115	From p. 121
Thin flat	—	UT							●	●	●							From p. 87	From p. 115	From p. 121
	With ribs	CT							●	●	●							From p. 96	From p. 115	From p. 121
Deep	—	D							●	●		●		●				From p. 105	From p. 117	From p. 121

Vacuum Pad/Compact Type ZP3 Series Variations ▶ p. 134

Pad form	Symbol	Pad diameter [mm]												Page						
		ø1.5	ø2	ø3.5	ø4	ø6	ø8	ø10	ø13	ø16	ø20	ø25	ø32	ø40	ø50	Dimensions/Models	Construction	Mounting bracket assembly		
Flat	—	U	●	●	●													From p. 137	From p. 160	From p. 162
	With groove	UM				●	●	●	●	●	●								From p. 143	From p. 160
Bellows	—	B				●	●	●										From p. 149	From p. 160	From p. 162
	With ribs	B							●	●	●							From p. 155	From p. 160	From p. 162

Oval Pad ZP/ZP2 Series Variations ▶ p. 167

Pad form	Series	Symbol	Pad size (Breadth x Length) [mm]								Page									
			2 x 4	3.5 x 7	4 x 10	4 x 20	4 x 30	5 x 10	5 x 20	5 x 30	6 x 10	6 x 20	6 x 30	8 x 20	8 x 30	Dimensions/Models	Construction	Mounting bracket assembly		
Oval	ZP	U	●	●	●													From p. 171	From p. 185	From p. 189
	ZP2	W		●	●	●	●	●	●	●	●	●	●	●	●	●	●		From p. 180	From p. 187













High Rigidity Pad ZP3E Series Variations ▶ p. 203

Pad form	Symbol	Pad diameter [mm]						Page							
		ø32	ø40	ø50	ø63	ø80	ø100	ø125	Dimensions/Models	Construction	Mounting bracket assembly				
Flat	With groove	UM	●	●	●	●	●	●	●	●	●	●	From p. 209	From p. 233	From p. 237
	Ball joint, With groove	F, UM	●	●	●	●	●	●	●	●	●	●	From p. 215	From p. 235	From p. 241
Bellows	With ribs and groove	BM	●	●	●	●	●	●	●	●	●	●	From p. 221	From p. 233	From p. 237
	Ball joint, With ribs and groove	F, BM	●	●	●	●	●	●	●	●	●	●	From p. 227	From p. 235	From p. 241











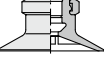
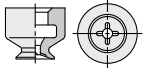

Pads for Special Applications

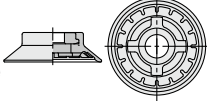
Variations ▶ p. 249

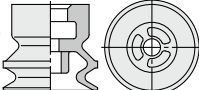
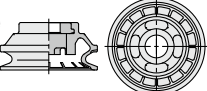
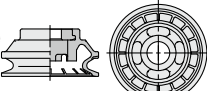
Page

Pad form		Series	Symbol	Pad diameter [mm]										How to order
Mark-free pad	Flat	—	ZP2	U, CL	ø4	ø6	ø8	ø10	ø16	ø25	ø32	ø40	ø50	p. 253
		With ribs	ZP2	H, CL/NT/FT	ø40	ø50	ø63	ø80	ø100	ø125	p. 254			
		With groove	ZP3E	UM, CL	ø32	ø40	ø50	ø63	ø80	ø100	ø125	p. 208		
		With groove, Ball joint type	ZP3E	F, UM, CL	ø32	ø40	ø50	ø63	ø80	ø100	ø125	p. 214		
	Bellows	With ribs and groove	ZP3E	BM, CL	ø32	ø40	ø50	ø63	ø80	ø100	ø125	p. 220		
		With groove, Ball joint type	ZP3E	F, BM, CL	ø32	ø40	ø50	ø63	ø80	ø100	ø125	p. 226		
Resin attachment	—	ZP2	K	ø6	ø8	ø10	ø13	ø16	ø20	ø25	ø32	p. 264		
Static neutralization		Flat type with groove	ZP3	HS	ø4	ø6	ø8	ø10	ø13	ø16	Web Catalog			
For film adsorption		2.5-stage	ZP3P	JT	ø20	ø25	ø32	ø40	ø50	Web Catalog				
		5.5-stage	ZP3P	JT	ø20	ø25	ø32	ø40	ø50	Web Catalog				
		With groove	ZP3P	PT	ø20	ø25	ø35	ø50	p. 267					
Multistage		4.5-stage	ZP2	ZJ	ø15	ø20	ø30	ø40	ø46	p. 276				
		2.5-stage 3.5-stage	ZP2	J	ø6	ø9	ø10	ø14	ø15	ø16	ø25	ø30	p. 282	
Flat pad		With groove	ZP2	MT	ø10	ø15	ø20	ø25	ø30	p. 286				
Nozzle type		—	ZP2	AN	ø0.8	ø1.1	p. 289							
Sponge		—	ZP2	S	ø4	ø6	ø8	ø10	ø15	p. 290				
For disk adsorption		—	ZP2	Z1	p. 294									
For panel holding		—	ZP2	Z	p. 295									
With ball spline buffer		Flat type	ZP2	U, S	ø2	ø4	ø6	ø8	p. 297					
Vacuum saving valve			ZP2V	p. 346										
Bernoulli gripper			ZNC	Web Catalog										
Non-contact gripper			XT661	p. 362										
Magnet gripper			MHM	Web Catalog										
			MHM-X6400	p. 373										

Select from pad forms

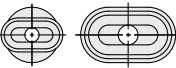
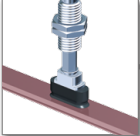
			Basic	Compact	High rigidity	Oval		
			ZP	ZP3	ZP3E	ZP	ZP2	
Flat	Flat type		<ul style="list-style-type: none">For the adsorption of general workpiecesFor the adsorption of workpieces with flat and non-deformed surfaces		p. 31	p. 136		
	Flat type with ribs		<ul style="list-style-type: none">For workpieces which are likely to become deformedFor the reliable release of workpieces		p. 50			
	Flat type with groove		<ul style="list-style-type: none">For workpieces which are likely to become deformedFor the reliable release of workpieces			p. 142	p. 208	
	Ball joint, Flat type		<ul style="list-style-type: none">For the adsorption of workpieces with inclined or curved surfaces		p. 61			
	Ball joint, Flat type with groove		<ul style="list-style-type: none">For the adsorption of workpieces with inclined or curved surfacesFor workpieces which are likely to become deformedFor the reliable release of workpieces				p. 214	
Bellows	Bellows type		<ul style="list-style-type: none">For the adsorption of workpieces with inclined surfacesFor workpieces of varying heights		p. 67	p. 148		
	Bellows type with ribs		<ul style="list-style-type: none">For the adsorption of workpieces with inclined surfacesFor workpieces of varying heightsFor the reliable release of workpieces			p. 154		
	Bellows type with ribs and groove		<ul style="list-style-type: none">To be used when the adsorption surface of the workpieces is slantedFor the reliable release of workpieces				p. 220	
	Ball joint, Bellows type with ribs and groove		<ul style="list-style-type: none">For the adsorption of workpieces with inclined or curved surfacesFor the reliable release of workpieces					p. 226
Thin flat	Thin flat type		<ul style="list-style-type: none">For workpieces which are likely to become deformed		p. 86			
	Thin flat type with ribs		<ul style="list-style-type: none">For workpieces which are likely to become deformedFor the reliable release of workpieces		p. 95			
Deep	Deep type		<ul style="list-style-type: none">For workpieces with curved surfaces		p. 104			
Oval	Oval flat type		<ul style="list-style-type: none">For workpieces with adsorption surface limitationsFor use when a large adsorption area is required for long and narrow workpieces				p. 170	p. 179

Select according to the workpiece, application, or industry

Film packaging

Packaging facility

Food

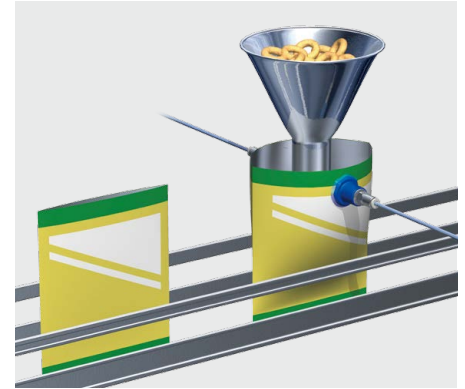
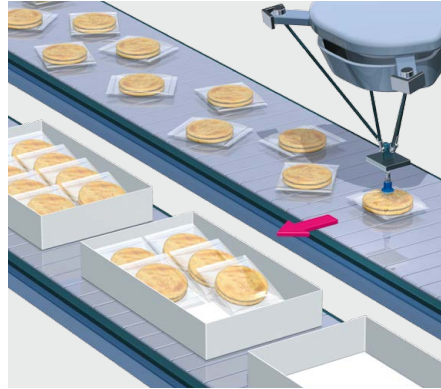
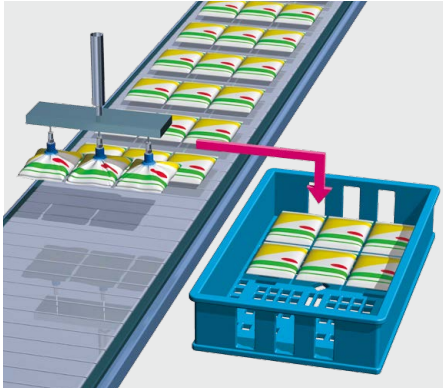

· Good for film packaging applications



· For the adsorption of workpieces randomly moving at high speed

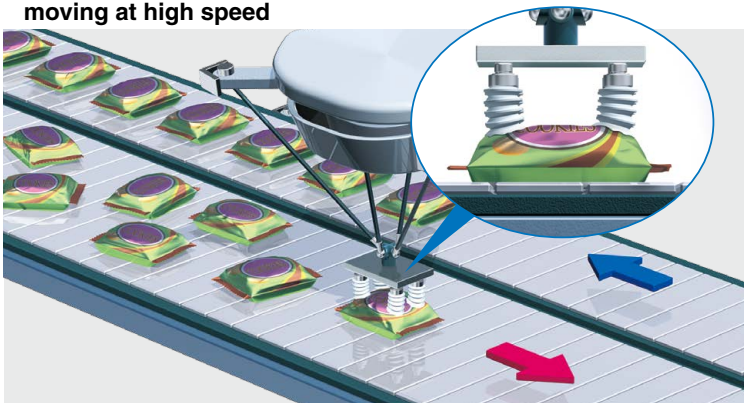

Applicable Pads

FDA regulation compliant

For Film Adsorption ZP3P-PT
p. 266

4.5-Stage Bellows Pad ZP2
p. 276



FDA regulation compliant

For Film Adsorption/Bellows ZP3P-JT

Web Catalog



Corrugated boards

Carton former

Palletizer

Food

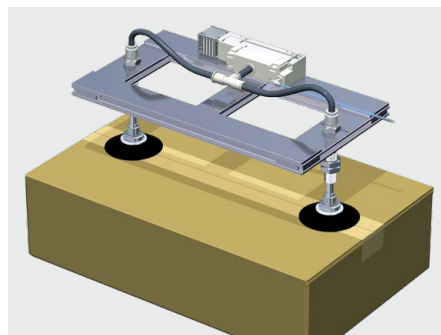
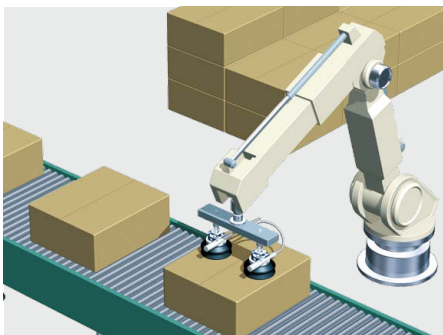

Applicable Pads

High Rigidity Pad ZP3E

p. 200



Select according to the workpiece, application, or industry

Glass

Automobile

Electronics

· For use where adsorption marks must not be left on workpieces

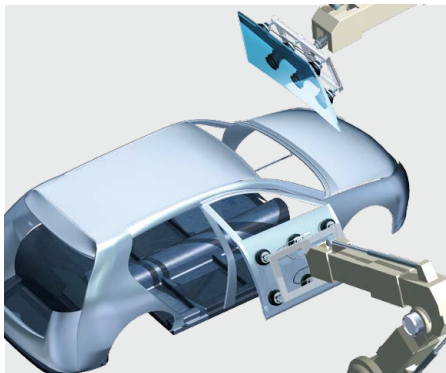

Applicable Pads

Mark-free Pad ZP3E
p. 200



Mark-free Pad ZP2
p. 251



FPD, Glass circuit boards

Automobile

Electronics

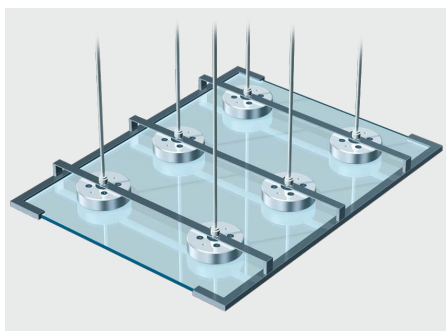

Applicable Pads

Mark-free Pad ZP3E
p. 200



Mark-free Pad ZP2
p. 251



Non-contact Gripper
XT661
p. 353



Iron plates, Metal

Automobile

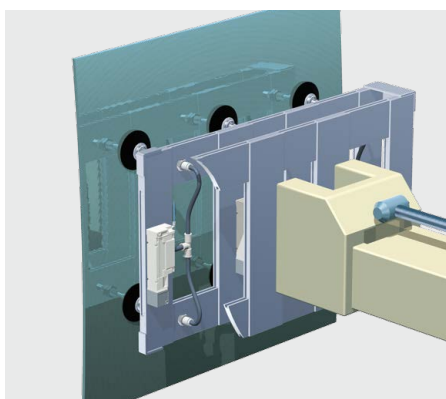

Applicable Pads

High Rigidity Pad ZP3E
p. 200

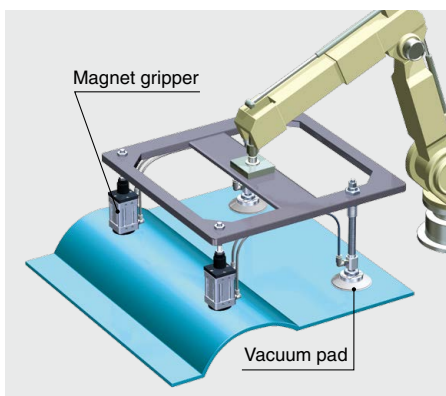

Applicable Pads

Magnet Gripper
MHM
MHM-X6400
Web Catalog
p. 372



IC chips

Electronics



Applicable Pads

Nozzle Pad ZP2

p. 289



Compact Type ZP3

p. 132

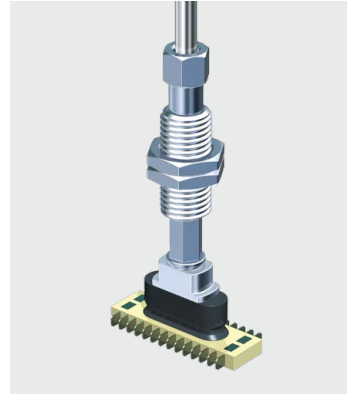

Applicable Pads

Oval Pad ZP

p. 170



Oval Pad ZP2

p. 179



Applicable Pads

Pad with Ball Spline Buffer ZP2

p. 297



Applicable Pads

Sponge Pad ZP2

p. 290



Applicable Pads

Static Neutralization Pad ZP3-HS

Web Catalog



Solar battery cells

Electronics

Circuit boards with holes

Electronics

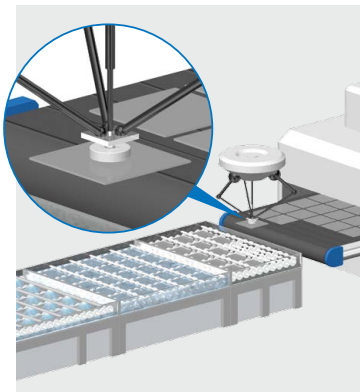

Applicable Pads

Non-contact Gripper XT661

p. 353



Applicable Pads

Non-contact Gripper XT661

p. 353



Mounting Bracket Assembly Model Index

Assembly part no.		Basic		Compact	Oval		High Rigidity		Special applications																
		ZP		ZP3	ZP	ZP2	ZP3E		Mark-free		Static Neutralization	For film adsorption		Multistage		Flat	Nozzle	Sponge							
		Standard	Ball joint	Standard	Standard	Standard	Standard	Ball joint	Standard	Ball joint	Standard	Ball joint	HS□	Standard	JT	J	ZJ	MT	ZP2	ZP2	ZP2	ZP2			
ZP	ZPB1	Buffer plate																							
	ZPB(1/2/3)(J/K)-	Buffer assembly																							
	ZPR(S/L)-	Adapter assembly																							
	ZPRF(1/2/3)-	Adapter assembly/ Ball joint																							
	ZPT(1/2/3/4)-	Adapter assembly																							
	ZPTF(1/2/3)-	Adapter assembly/ Ball joint																							
	ZPY(1/2/3/4)-	Adapter assembly																							
ZP2	ZPA-	Adapter assembly																							
	ZPB-	Buffer assembly																							
	ZP2A-	Adapter																							
	ZP2B-	Buffer assembly																							
ZP3	ZP3A-	Adapter assembly																							
	ZP3B-	Buffer assembly																							
ZP3E	ZP3EA-	Holder, Plate, Stopper, Set screw, Adapter																							
	ZP3EA-F	Ball joint assembly																							
	ZP3EB-	Buffer assembly																							
	ZP3EU-(T/Y)F	Ball joint buffer unit																							
ZP3P	ZP3EU-F	Ball joint unit																							
	ZP3PA-	Adapter assembly																							
Mounting nut	ZP3P□A-	Adapter assembly																							
	NTJ-015A																								
	SNJ-006C																								
	ZPNA-M6A																								
	RB08J																								
	ZPNA-M8A																								
	ZPNA-M10																								
	ZPNA-M12																								
	ZPNA-M12A																								
	ZPNA-M12C																								
	ZPNA-M14																								
	ZPSNA-M16A																								
	ZPSNA-M20																								
	KQ08-P01A																								
	KQ10-P01A																								
RBQ16J																									
NT-05																									
ZPNA-M22																									

Vacuum Pads

Basic Pad
ZP Series



p. 26

Compact Type
ZP3 Series



p. 132

Oval Pad
ZP/ZP2 Series



p. 166

High Rigidity Pad
ZP3E Series



p. 200

Pads for Special Applications
ZP2/ZP3P Series



p. 248

Made to Order
ZP/ZP2 Series



p. 298

Vacuum Saving Valve
ZP2V Series

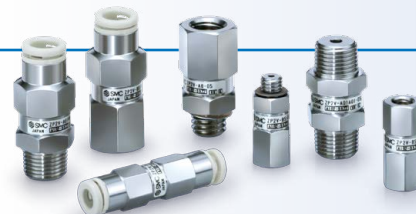

p. 344

Non-contact Gripper
XT661 Series



p. 353

Magnet Gripper
MHM-X6400



p. 372

Model Selection p. 4

Basic Pad ZP Series

p. 26

ø2, ø4, ø6, ø8, ø10, ø13, ø16, ø20, ø25, ø32, ø40, ø50



Variations p. 27
 Specifications p. 29

■ **Flat Type**

How to Order p. 31
 Dimensions/Models p. 32

■ **Flat Type with Ribs**

How to Order p. 50
 Dimensions/Models p. 51

■ **Flat, Ball Joint Type**

How to Order p. 61
 Dimensions/Models p. 62

■ **Bellows Type**

How to Order p. 67
 Dimensions/Models p. 68

■ **Thin Flat Type**

How to Order p. 86
 Dimensions/Models p. 87

■ **Thin Flat Type with Ribs**

How to Order p. 95
 Dimensions/Models p. 96

■ **Deep Type**

How to Order p. 104
 Dimensions/Models p. 105

Construction

Flat type/Flat type with ribs/Bellows type/Thin flat type/
 Thin flat type with ribs/Deep type p. 115
 Flat, Ball joint type p. 119

Mounting Bracket Assembly

Flat type/Flat type with ribs/Bellows type/Thin flat type/
 Thin flat type with ribs/Deep type p. 121
 Flat, Ball joint type p. 127

Specific Product Precautions p. 165

Compact Type ZP3 Series

p. 132

ø1.5, ø2, ø3.5, ø4, ø6, ø8, ø10, ø13, ø16



Features p. 133
 Variations p. 134
 Specifications p. 135

■ **Flat Type**

How to Order p. 136
 Dimensions/Models p. 137

■ **Flat Type with Groove**

How to Order p. 142
 Dimensions/Models p. 143

■ **Bellows Type**

How to Order p. 148
 Dimensions/Models p. 149

■ **Bellows Type with Ribs**

How to Order p. 154
 Dimensions/Models p. 155

Construction p. 160

Mounting Bracket Assembly p. 162

Specific Product Precautions p. 165

Oval Pad ZP/ZP2 Series

p. 166

2 x 4, 3.5 x 7, 4 x 10, 4 x 20, 4 x 30, 5 x 10, 5 x 20, 5 x 30, 6 x 10,
 6 x 20, 6 x 30, 8 x 20, 8 x 30

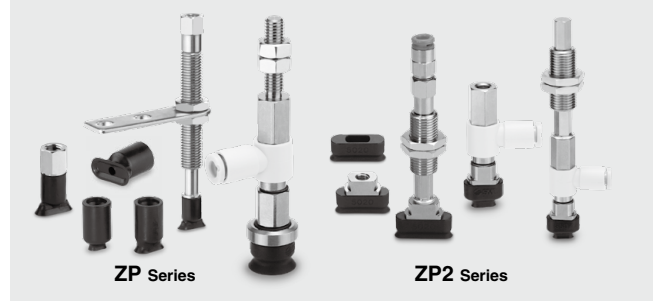

Variations p. 167
 Specifications p. 168

■ **Oval Flat Type/ZP Series**

How to Order p. 170
 Dimensions/Models p. 171

■ **Oval Flat Type/ZP2 Series**

How to Order..... p. 179
 Dimensions/Models..... p. 180

Construction

 ZP Series..... p. 185
 ZP2 Series..... p. 187

Mounting Bracket Assembly

 ZP Series..... p. 189
 ZP2 Series..... p. 195

Specific Product Precautions..... p. 198

High Rigidity Pad ZP3E Series p. 200

ø32, ø40, ø50, ø63, ø80, ø100, ø125



Features..... p. 201
 Variations..... p. 203
 Specifications..... p. 204

■ **Flat Type with Groove**

How to Order..... p. 208
 Dimensions/Models..... p. 209

■ **Ball Joint, Flat Type with Groove**

How to Order..... p. 214
 Dimensions/Models..... p. 215

■ **Bellows Type with Ribs and Groove**

How to Order..... p. 220
 Dimensions/Models..... p. 221

■ **Ball Joint, Bellows Type with Ribs and Groove**

How to Order..... p. 226
 Dimensions/Models..... p. 227

Construction

 Standard Type..... p. 233
 Ball Joint Type..... p. 235

Mounting Bracket Assembly

 Standard Type..... p. 237
 Ball Joint Type..... p. 241

How to Replace the Pad..... p. 245
 Specific Product Precautions..... p. 246

Pads for Special Applications ZP2/ZP3P Series p. 248

ø0.8 to ø125

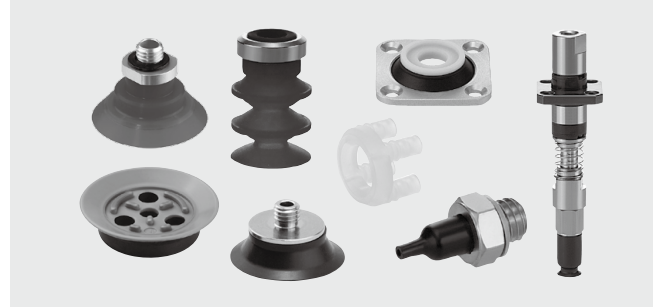

Pad Material..... p. 248
 Variations..... p. 249

■ **Mark-free**

Mark-free Pad Series ZP2/ZP3E Series..... p. 251

Mark-free Pad

 ø4, ø6, ø8, ø10, ø16, ø25, ø32, ø40, ø50..... p. 253

Mark-free Pad/High Rigidity

 ø40, ø50, ø63, ø80, ø100, ø125..... p. 254

 Mounting Bracket Assembly..... p. 255

 Mounting Bracket Assembly (Ball Joint Type)..... p. 261

Resin Attachment

 ø6, ø8, ø10, ø13, ø16, ø20, ø25, ø32..... p. 264

Specific Product Precautions..... p. 265

■ **For Film Adsorption**

Vacuum Pad ZP3P Series

 ø20, ø25, ø35, ø50..... p. 266

 [Pad Unit] How to Order, Dimensions..... p. 267

 [With Adapter] How to Order, Dimensions..... p. 268

 [With Buffer] How to Order, Dimensions..... p. 271

 Construction..... p. 274

 Parts Structure..... p. 275

■ **Multistage**

Bellows Pad (4.5-Stage)

 ø15, ø20, ø30, ø40, ø46..... p. 276

 [Pad Unit] How to Order, Dimensions..... p. 276

 [With Adapter] How to Order, Dimensions..... p. 277

 Component Parts..... p. 279

 Pad Displacement to Vacuum Pressure..... p. 280

 Mounting Bracket Assembly..... p. 281

Bellows Pad (2.5/3.5-Stage)

 ø6, ø9, ø10, ø14, ø15, ø16, ø25, ø30..... p. 282

 Mounting Bracket Assembly..... p. 283

■ **Flat**

Flat Pad
 ø10, ø15, ø20, ø25, ø30 p. 286
 [Pad Unit] How to Order, Dimensions p. 286
 [With Adapter] How to Order, Dimensions p. 287
 Mounting Bracket Assembly p. 288

■ **Nozzle**

Nozzle Pad
 ø0.8, ø1.1 p. 289

■ **Sponge**

Sponge Pad
 ø4, ø6, ø8, ø10, ø15 p. 290
 [Pad Unit] How to Order, Dimensions p. 290
 [With Adapter] How to Order, Dimensions p. 291
 Mounting Bracket Assembly p. 293

■ **For Disk Adsorption**

Vacuum Pad for Disk Adsorption p. 294

■ **For Panel Holding**

Vacuum Pad for Panel Holding p. 295

■ **Ball Spline Buffer**

Pad with Ball Spline Buffer
 ø2, ø4, ø6, ø8 p. 297

Made to Order ZP/ZP2 Series **p. 298**
 ø2 to ø340



Pad Material p. 298
 Variations p. 299

■ **Compact/Short-type**

Compact Pad
 ø3, ø4, ø6, ø7, ø8 p. 304
 Short-type Pad (Flat type)
 ø2, ø3.5, ø4, ø5, ø6, ø8, ø10, ø15 p. 305
 Short-type Pad (Flat type)
 ø2, ø4, ø6, ø8, ø15 p. 308
 Short-type Pad (Flat type)
 ø2, ø3, ø4, ø6, ø8 p. 311

■ **Thin Flat**

Thin Flat Pad
 ø5, ø6, ø11, ø14, ø18, ø20 p. 312
 Mounting Bracket Assembly p. 313

■ **Bellows**

Bellows Pad (Bellows type)
 ø4, ø6, ø8, ø10, ø15, ø20 p. 314
 Bellows Pad (Bellows type)
 ø2, ø4, ø5, ø6 p. 316

■ **High Rigidity**

High Rigidity Pad (Flat type with ribs/Thin flat type with ribs)
 ø32, ø150, ø250, ø300, ø340 p. 317
 High Rigidity Pad (Bellows type)
 ø32, ø150 p. 319
 High Rigidity Pad (Oval type)
 30 x 50 p. 320
 High Rigidity Ball Joint Pad (Flat type with ribs)
 ø40, ø50, ø63, ø80, ø100, ø125 p. 321
 High Rigidity Ball Joint Pad (Bellows type)
 ø40, ø50, ø63, ø80, ø100, ø125 p. 327
 High Rigidity Pad (Flat type with ribs/Bellows type)
 ø40, ø50, ø63, ø80, ø100, ø125 p. 333

Specific Product Precautions p. 343

Vacuum Saving Valve ZP2V Series **p. 344**



Non-contact Gripper XT661 Series **p. 353**



Magnet Gripper MHM-X6400 **p. 372**



Safety Instructions p. 375
 Vacuum Equipment Precautions p. 376
 Vacuum Pads Precautions p. 379

1 Features and Precautions for Vacuum Adsorption p. 5

2 Vacuum Pad Selection p. 5

- Vacuum Pad Selection Procedures
- Points for Selecting Vacuum Pads
 - A. Shear Force and Moment Applied to Vacuum Pads
 - B. Theoretical Lifting Force
- Lifting Force and Vacuum Pad Diameter
- Vacuum Pad Type
- Vacuum Pad Material
- Rubber Material and Properties
- Buffer Attachment
- Pad Selection by Workpiece Type
- Vacuum Pad Durability

3 Vacuum Ejector and Vacuum Switching Valve Selection p. 12

- Formula for Calculating Vacuum Ejector and Switching Valve Size

4 Leakage Volume during Workpiece Adsorption p. 12

- Leakage Volume from Conductance of Workpieces
- Leakage Volume from Suction Test

5 Adsorption Response Time p. 13

- Relationship between Vacuum Pressure and Response Time after Supply Valve (Switching Valve) is Operated
- Formula for Calculating Adsorption Response Time
- Adsorption Response Time from the Selection Graph

6 Precautions for Vacuum Equipment Selection and SMC's Proposals p. 15

- Safety Measures
- Precautions for Vacuum Equipment Selection
- Vacuum Ejector or Pump and Number of Vacuum Pads
- Vacuum Ejector Selection and Handling Precautions
- Supply Pressure of Vacuum Ejector
- Timing for Vacuum Generation and Suction Verification
 - A. Timing for Vacuum Generation
 - B. Suction Verification
 - C. Set Pressure for Vacuum Pressure Switch
- Dust and Vacuum Equipment

7 Vacuum Equipment Selection Example p. 19

- Transfer of Semiconductor Chips

8 Data p. 20

- Selection Graph
- Glossary of Terms
- Countermeasures for Vacuum Adsorption Problems (Troubleshooting)
- Examples of Non-conformance
- Vacuum Pad Replacement Period

1 Features and Precautions for Vacuum Adsorption

Systems which use vacuum adsorption as a method to hold workpieces have the following features.

- Compared with mechanical grippers and other similar products, they have a simpler construction and fewer moving parts.
- Workpieces of any shape can be adsorbed if they have an adsorption surface.
- No need for accurate positioning
- Compatible with soft and easily-deformed workpieces

However, special care is required regarding the following.

- Be careful not to drop workpieces during transfer. (Make sure there is no excessive acceleration, vibration, or impact.)
- The piping may become clogged by liquid or particles suctioned near the workpieces.
- It is necessary to appropriately position the pads in order to transfer heavy objects.
- The vacuum pads (rubber) will deteriorate at a rate depending on the operating environment and conditions.
- As the product life (replacement period) depends on the customer's operating conditions, it cannot be estimated beforehand.

A suction test with the actual equipment is recommended before selecting the product model.

Consider the features and precautions shown above, perform periodic maintenance, and take corrective actions regarding the operating conditions.

2 Vacuum Pad Selection

Vacuum Pad Selection Procedures

- 1) Fully taking into account the balance of a workpiece, identify the suction position, number of pads, and applicable pad diameter (or pad area).
 - * When selecting a model based on workpiece mass, there is a possibility that the workpieces won't be able to be adsorbed or that they will be dropped depending on the operating conditions (workpiece balance, transfer acceleration, pressure or friction force applied to the workpieces during transfer, etc.).
- 2) Find the theoretical lifting force from the identified adsorption area (pad area x number of pads) and the vacuum pressure, and then find the lifting force considering the safety factor of the actual lifting method and transfer conditions.
 - * Use the calculated values as a guideline (reference value) and check the actual values by performing a suction test as necessary.
- 3) Determine the necessary pad diameter (pad area) and suction position (workpiece balance) so that the lift force is larger than the weight of the workpieces.
- 4) Determine the pad form and materials, the necessity of a buffer based on the operating environment, and the workpiece shape and materials.
- 5) This product is not designed to hold vacuum.
- 6) Perform a suction test with the actual equipment to determine whether or not the product can be used.

The above shows the selection procedure for general vacuum pads; thus, it is not applicable to all pads. Customers are required to conduct a test on their own and to select applicable suction conditions and pads based on their test results.

Points for Selecting Vacuum Pads

A. Shear Force and Moment Applied to Vacuum Pads

- a) Vacuum pads are susceptible to shear force (parallel force with adsorption surface) and moment.
- b) Minimize the moment applied to the vacuum pads with the position of the workpiece center of gravity in mind.
- c) The acceleration rate of the movement must be as small as possible, so be sure to take into consideration the wind pressure and impact. If measures to slow down the acceleration rate are introduced, workpieces will be less likely to be dropped.
- d) Avoid lifting workpieces by adsorbing the vertical side with vacuum pads (vertical lifting).
When it is unavoidable, a sufficient safety factor must be secured.

Lifting Force, Moment, Horizontal Force

- (Refer to Fig. 1) To lift workpieces vertically, be sure to take into consideration the acceleration rate, wind pressure, impact, etc., in addition to the mass of the workpieces.
- (Refer to Fig. 2) Because the pads are susceptible to moments, mount the pads so as not to allow the workpieces to create a moment.
- (Refer to Fig. 3) When workpieces that are suspended horizontally are moved laterally, they could shift depending on the extent of the acceleration rate or the size of the friction coefficient between the pad and the workpiece. Therefore, the acceleration rate of the lateral movement must be minimized.

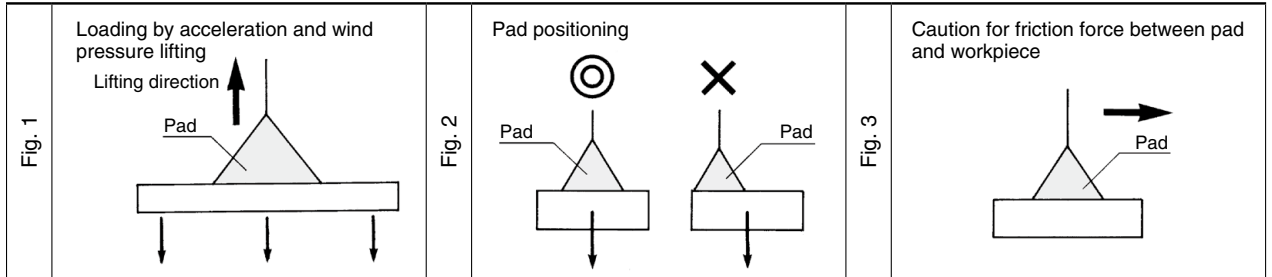

Balance of Pad and Workpiece

- 1) Make sure that the pad's adsorption area is not larger than the surface of the workpiece to prevent vacuum leakage and unstable suction.
- 2) If multiple pads are used for transferring a flat object with a large surface area, properly allocate the pads to maintain balance. Also, make sure that the pads are aligned properly to prevent them from becoming disengaged along the edges.

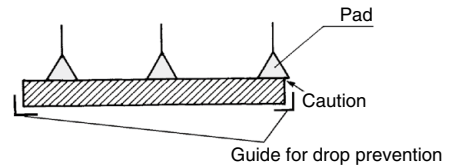
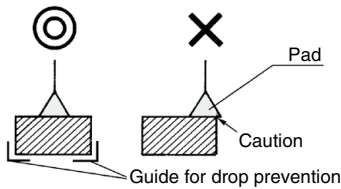

Provide an auxiliary device (example: a guide for preventing workpieces from dropping) as necessary.

* Mount the guide for drop prevention so that no load is applied to the workpieces (it does not push the workpieces up). If a load is applied, it is applied to the pad when the guide for drop prevention is removed. This may cause workpieces to be dropped.

- 3) Consider that the load may increase at a certain place due to the suction balance.

Formula examples with beams (Reference)

Load/Shape conditions			
Formula (Reactive force: R, Total load: W)	$RA = RB = P/2$ $W = P$	$RA = Pb/L$ $RB = Pa/L$ $W = P$	$RA = RC = 5Pb/16$ $RB = 11P/8$

Mounting Position

The basic mounting method is a horizontal lift. Do not perform suction when tilted, vertical suction, or holding suction (as the pads receive the load of the workpieces). If the unit must be installed in such a manner, be sure to provide a guide and take appropriate safety measures.

The vacuum pad is designed for workpiece transfer while suctioned from above. If workpieces are to be suctioned from below or held with the pad after being positioned by other components, perform a suction test to determine whether or not the transfer method is applicable.

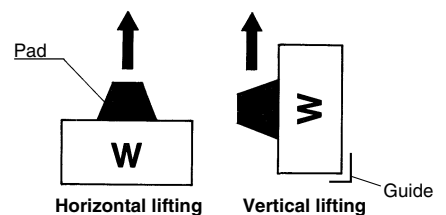

B. Theoretical Lifting Force

- The theoretical lifting force is determined by the vacuum pressure and the contact area of the vacuum pad.
- Since the theoretical lifting force is the value measured at the static state, the safety factor responding to the actual operating conditions must be estimated.
- It is not necessarily true that higher vacuum pressure is better. Extremely high vacuum pressure may cause problems.
 - If the vacuum pressure is higher than necessary, an increase in the friction of the pads, the generation of cracks, the sticking of the pads to workpieces, and the sticking of the pads (bellows pad) are more likely to occur, possibly shortening the life of the pads.
 - Doubling the vacuum pressure makes the theoretical lifting force double, while doubling the pad diameter makes the theoretical lifting force quadruple.
 - When the vacuum pressure (set pressure) is high, it makes not only the response time longer but also the necessary energy to generate vacuum larger.

Example) Theoretical lifting force = Pressure x Area 2 times →

Pad diameter \ Area [cm ²]		Vacuum pressure [-40 kPa]	Vacuum pressure [-80 kPa]
∅20	3.14	Theoretical lifting force 12 N	Theoretical lifting force 25 N
∅40	12.56	Theoretical lifting force 50 N	Theoretical lifting force 100 N

↓ 4 times

Lifting Force and Vacuum Pad Diameter

- The vacuum pressure should be set below the pressure that has been stabilized after adsorption. However, when workpieces are permeable or have a rough surface, note that the vacuum pressure drops since the workpieces take in air. In such cases, it is necessary to perform a suction test to check the vacuum pressure reached during suction.
- The vacuum pressure when using an ejector is approximately -40 to -60 kPa as a guide.

The theoretical lifting force of a pad can be found by calculation or from the theoretical lifting force table.

Calculation

$$W = P \times S \times 0.1 \times \frac{1}{t}$$

- W: Lifting force [N]
- P: Vacuum pressure [kPa]
- S: Pad area [cm²]
- t: Safety factor
Horizontal lifting: 4 or more
Vertical lifting: 8 or more

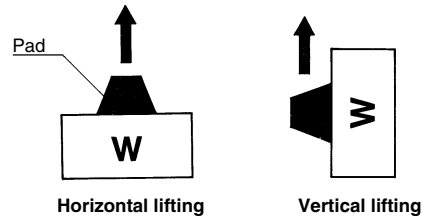

(This type of application should generally be avoided.)

Theoretical Lifting Force

The theoretical lifting force (not including the safety factor) can be determined by the pad diameter and vacuum pressure. The required lifting force can then be determined by dividing the theoretical lifting force by the safety factor t.

Lifting force = Theoretical lifting force ÷ t

Theoretical Lifting Force (Theoretical lifting force = P x S x 0.1)

Pad Size (∅1.5 to ∅50)

Pad size [mm]	∅1.5	∅2	∅3.5	∅4	∅6	∅8	∅10	∅13	∅16	∅20	∅25	∅32	∅40	∅50
S: Pad area [cm ²]	0.02	0.03	0.10	0.13	0.28	0.50	0.79	1.33	2.01	3.14	4.91	8.04	12.6	19.6
Vacuum pressure [kPa]	-85	0.15	0.27	0.82	1.07	2.40	4.2	6.6	11	17	26	41	68	106
	-80	0.14	0.25	0.77	1.00	2.26	4.0	6.2	10	16	25	39	64	100
	-75	0.13	0.24	0.72	0.94	2.12	3.7	5.8	10	15	23	36	60	94
	-70	0.12	0.22	0.67	0.88	1.98	3.5	5.5	9.3	14	22	34	56	87
	-65	0.11	0.20	0.63	0.82	1.84	3.2	5.1	8.6	13	20	31	52	81
	-60	0.11	0.19	0.58	0.75	1.70	3.0	4.7	8.0	12	18	29	48	75
	-55	0.10	0.17	0.53	0.69	1.55	2.7	4.3	7.3	11	17	27	44	69
	-50	0.09	0.16	0.48	0.63	1.41	2.5	3.9	6.7	10	15	24	40	62
	-45	0.08	0.14	0.43	0.57	1.27	2.2	3.5	6.0	9.0	14	22	36	56
-40	0.07	0.13	0.38	0.50	1.13	2.0	3.1	5.3	8.0	12	19	32	50	

Pad Size (ø63 to ø340)

[N]

Pad size [mm]	ø63	ø80	ø100	ø125	ø150	ø200	ø250	ø300	ø340	
S: Pad area [cm ²]	31.2	50.2	78.5	122.7	176.6	314.0	490.6	706.5	907.5	
Vacuum pressure [kPa]	-85	265	427	667	1043	1501	2669	4170	6005	7714
	-80	250	402	628	982	1413	2512	3925	5652	7260
	-75	234	377	589	920	1325	2355	3680	5299	6806
	-70	218	351	550	859	1236	2198	3434	4946	6353
	-65	203	326	510	798	1148	2041	3189	4592	5899
	-60	187	301	471	736	1060	1884	2944	4239	5445
	-55	172	276	432	675	971	1727	2698	3886	4991
	-50	156	251	393	614	883	1570	2453	3533	4538
	-45	140	226	353	552	795	1413	2208	3179	4084
-40	125	201	314	491	706	1256	1962	2826	3630	

Oval Pad (2 x 4 to 8 x 30, 30 x 50)





[N]





Pad size [mm]	2 x 4	3.5 x 7	4 x 10	5 x 10	6 x 10	4 x 20	5 x 20	6 x 20	8 x 20	4 x 30	5 x 30	6 x 30	8 x 30	30 x 50	
S: Pad area [cm ²]	0.07	0.21	0.36	0.44	0.52	0.76	0.94	1.12	1.46	1.16	1.44	1.72	2.26	13.07	
Vacuum pressure [kPa]	-85	0.60	1.79	3.0	3.7	4.4	6.4	7.9	9.5	12.4	9.8	12.2	14.6	19.2	112
	-80	0.56	1.68	2.8	3.5	4.1	6.0	7.5	8.9	11.6	9.2	11.5	13.7	18.0	105
	-75	0.53	1.58	2.7	3.3	3.9	5.7	7.0	8.4	10.9	8.7	10.8	12.9	16.9	98
	-70	0.49	1.47	2.5	3.0	3.6	5.3	6.5	7.8	10.2	8.1	10.0	12.0	15.8	92
	-65	0.46	1.37	2.3	2.8	3.3	4.9	6.1	7.2	9.4	7.5	9.3	11.1	14.6	85
	-60	0.42	1.26	2.1	2.6	3.1	4.5	5.6	6.7	8.7	6.9	8.6	10.3	13.5	79
	-55	0.39	1.16	1.9	2.4	2.8	4.1	5.1	6.1	8.0	6.3	7.9	9.4	12.4	72
	-50	0.35	1.05	1.8	2.2	2.6	3.8	4.7	5.6	7.3	5.8	7.2	8.6	11.3	66
	-45	0.32	0.95	1.6	1.9	2.3	3.4	4.2	5.0	6.5	5.2	6.4	7.7	10.1	59
-40	0.28	0.84	1.4	1.7	2.0	3.0	3.7	4.4	5.8	4.6	5.7	6.8	9.0	53	

Vacuum Pad Type

- Various types of vacuum pads are available such as flat, deep, bellows, thin flat, with ribs, oval, etc. Select the optimal form in accordance with the workpiece type and the operating environment. Please contact SMC for shapes not included in this catalog.

Pad Type

Pad form	Application
Flat type Flat type with groove 	To be used when the adsorption surface of workpieces is flat and not deformed
Flat type with ribs 	To be used when workpieces are likely to become deformed or for the reliable release of workpieces
Deep type 	To be used when workpieces are curved in shape
Bellows type Bellows type with groove 	To be used when there is not enough space to install a buffer or when the adsorption surface of workpieces is slanted
Oval type 	To be used when workpieces have a limited adsorption surface or are long in length and when the accurate positioning of workpieces is required

Pad form	Application
Ball joint pad 	To be used when the adsorption surface of workpieces is not horizontal
Conductive pad 	As a countermeasure against static electricity, rubber material with reduced resistance is used.
For film adsorption 	For film packaging applications
Nozzle type 	For small workpieces such as IC chips
Sponge 	For workpieces with bumps

Vacuum Pad Material

- It is necessary to determine vacuum pad materials carefully taking into account the shape of the workpieces, adaptability in the operating environment, effect after being adsorbed, electrical conductivity, etc.
- Based on the workpiece transfer example for each material, select after confirming the characteristics (adaptability) of the rubber.

Vacuum Pad/Workpiece Transfer Examples for Each Material

Material	Application
NBR, Conductive NBR	General workpieces, Corrugated boards, Veneer plates, Iron plates, etc.
Silicone rubber, Conductive silicone rubber	Semiconductors, Removal from die-casting, Thin workpieces, Food processors
Urethane rubber	Corrugated boards, Iron plates, Veneer plates
FKM	Chemical workpieces

- As the following materials are not suitable for use in specific environments, please select from the recommended materials.

Material	Specific environment	Example of problem	Recommended material
NBR, Conductive NBR	<ul style="list-style-type: none"> Ozone environments <Examples> In clean rooms Around static removal equipment Around motor devices 	Cracks are generated earlier on the portions to which stress is applied.	Silicone rubber Urethane rubber FKM Conductive silicone rubber
Urethane rubber	<ul style="list-style-type: none"> High-temperature, high-humidity environments 	Deformation, discoloration, or cracking occurs Adhesiveness increases	NBR Silicone rubber FKM Conductive silicone rubber

Rubber Material and Properties

- ◎ = Excellent --- Not affected at all, or almost no effect △ = Better not to use if possible
 ○ = Good --- Affected a little, but adequate resistance depending on conditions × = Unsuitable for usage. Severely affected.

General name	NBR (Nitrile rubber)		Silicone rubber			Urethane rubber	FKM (Fluoro rubber)	CR (Chloroprene rubber)	EPDM (Ethylene propylene diene rubber)	Sponge (Chloroprene sponge)	
	—	Conductive	—	Semiconductive	Conductive						
Main features	Can be used in a wide range of general-use applications due to superior oil resistance		Excellent workpiece surface suction ability due to product flexibility Can be used in a wide range of operating temperatures due to excellent heat resistance and cold resistance Superior ozone resistance FDA and Food Sanitation Law compliant (excluding conductive silicone rubber)			Excellent mechanical strength and superior abrasion resistance Superior ozone resistance	An all-purpose material exhibiting superior performance in a wide variety of applications Superior abrasion resistance, heat resistance, ozone resistance, chemical resistance, and oil resistance	Can be used in a wide range of general-use applications due to superior ozone resistance	Excellent resistance to alcohols and ketones Superior ozone resistance	Excellent uneven workpiece surface suction ability due to product flexibility Can be used in a wide range of general-use applications due to superior ozone resistance	
Pure rubber property (specific gravity)	1.00-1.20		0.95-0.98			1.00-1.30	1.80-1.82	1.15-1.25	0.86-0.87	0.161 g/cm ³	
Physical properties of compounded rubber	Impact resilience	○	◎			◎	△	◎	○	× to △	
	Abrasion resistance	◎	× to △			◎	◎	◎	○	×	
	Tear resistance	○	× to △			◎	○	○	△	×	
	Flex crack resistance	○	× to ○			◎	○	○	○	×	
	Max. operating temperature [°C]	120	100	200			60	250	150	150	120
	Min. operating temperature [°C]	0		-30	-10		0	0	-40	-20	-20
	Volume resistivity [Ωcm]	—	10 ⁴ or less	—	—	10 ⁴ or less	—	—	—	10 ⁵ or less	
	Surface resistance [Ω]	—		—	10 ⁶ to 10 ⁹	—	—	—	—	—	
	Heat aging	○		◎			△	◎	○	○	△
	Weather resistance	×		◎			◎	◎	◎	○	△
Ozone resistance	×		◎			◎	◎	○	◎	○	
Gas permeability resistance	○		× to △			× to △	× to △	○	× to △	×	
Solvent resistance	Gasoline/Gas oil	◎		× to △			◎	◎	○	×	×
	Benzene/Toluene	× to △		×			× to △	◎	× to △	×	×
	Alcohol	◎		◎			△	△ to ◎	◎	◎	△
	Ether	× to △		× to △			×	× to △	× to △	○	×
	Ketone (MEK)	×		○			×	×	△ to ○	◎	×
Alkaline resistance	Ethyl acetate	× to △		△			× to △	×	× to △	◎	×
	Water	◎		○			×	◎	◎	◎	○
	Organic acid	× to △		○			×	△ to ○	× to △	×	×
	Organic acid of high concentration	△ to ○		△			×	◎	○	○	×
	Organic acid of low concentration	○		○			△	◎	◎	◎	×
	Strong alkali	○		◎			×	○	◎	◎	△
Weak alkali	○		◎			×	○	◎	◎	△	

* The indicated physical properties, chemical resistance, and other numerical values are only approximate values to be used for reference. They are not guaranteed values.
 · The above general characteristics may change according to the working conditions and the working environment.
 · When determining the material, carry out adequate confirmation and verification in advance.
 · SMC will not bear responsibility concerning the accuracy of data or any damage arising from this data.

Buffer Attachment

- Choose the buffer type when the workpieces are of varying heights, the workpieces are fragile, or you need to reduce the impact to the pads. If rotation needs to be limited, use a non-rotating buffer.
- The buffer is manufactured for the purpose of protecting the pads from impact when the pads are applied to workpieces. An eccentric load applied to the buffer caused by piping (tubing) or the position of the attachment, or an improper tightening torque used when the buffer is attached may lead to poor sliding or a shortened product life. Also, minimize the load in the lateral direction.
- Prevent eccentric loads caused by piping (tubing) from being applied to the buffer. Route the tube piping with some degree of freedom, and ensure that it extends in the direction of the fitting. Also, make adjustments as required to prevent long piping, piping bundles, piping material, etc., from becoming a load.
- Use the buffer within the stroke.

Unsteady Distance between Pads and Workpieces

When the workpieces are of varying heights, use the buffer type pad with a built-in spring. The spring creates a cushion effect between the pads and the workpieces. If rotation needs to be limited further, use the non-rotating buffer type.

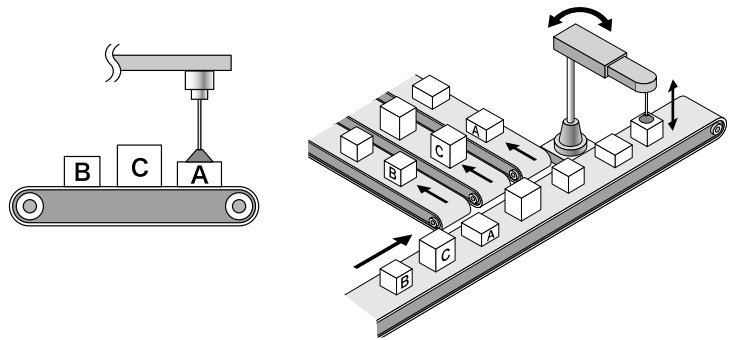

Pad Selection by Workpiece Type

- Carefully select the pads for the following workpieces.

1. Porous Workpieces

To adsorb permeable workpieces such as paper, select pads with a small diameter that are sufficient to lift the workpieces. Because a large amount of air leakage could reduce the pads' suction force, it may be necessary to increase the capacity of the ejector or vacuum pump or to enlarge the conductance area of the piping passage.

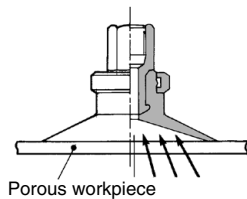

2. Flat Plate Workpieces

When workpieces with a large surface area such as sheet glass or PCB are suspended, the workpieces could move in a wavelike motion if a large force is applied by wind pressure or impact. Therefore, it is necessary to ensure the proper allocation and size of pads.

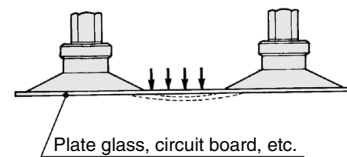

3. Soft Workpieces

When soft workpieces such as vinyl, paper, or thin sheets are adsorbed, the vacuum pressure could cause the workpieces to become deformed or wrinkle. In such cases, it will be necessary to use small pads or ribbed pads and reduce the vacuum pressure.

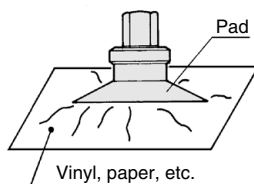

4. Impact to Pads



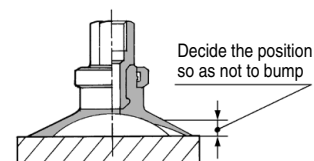



When pushing a pad to a workpiece, make sure not to apply an impact or a large force which would lead to premature deformation, cracking, or wearing of the pad. Pads should only be pushed against workpieces to the extent that their skirt portion deforms or their ribbed portion comes into slight contact with the workpieces. Especially, when using smaller diameter pads, make sure to position them correctly.



■ Pad Selection by Workpiece Type

5. Adsorption Marks

The main causes of adsorption marks are as follows:

	Before suction	After suction	Countermeasure
Marks due to deformed (lined) workpieces			1) Reduce the vacuum pressure. If the lifting force is inadequate, increase the number of pads. 2) Select a pad with a smaller center area.
	Suction conditions: Workpiece: Vinyl Vacuum pad: ZP20CS Vacuum pressure: -40 kPa		
Marks due to components contained in the rubber pads (material) moving to the workpieces			Use the following products. 1) Mark-free NBR pad 2) ZP2 series <ul style="list-style-type: none"> • Fluororesin-coated pad • Resin attachment
	Suction conditions: Workpiece: Glass Vacuum pad: ZP20CS Vacuum pressure: -40 kPa		
Marks which remain on the rough surface of the workpieces due to wearing of the rubber (pad material)			Use the following products. 1) ZP2 series <ul style="list-style-type: none"> • Fluororesin-coated pad • Resin attachment
	Suction conditions: Workpiece: Resin plate (Surface roughness 2.5 μ) Vacuum pad: ZP20CS Vacuum pressure: -80 kPa		

■ Vacuum Pad Durability

- The vacuum pads (rubber) need to be checked periodically for deterioration.
- When vacuum pads are used continuously, the following problems may occur.
 - 1) Wearing of the adsorption surface
 Shrinkage of the pad dimensions, sticking of the part where the rubber materials come into contact with each other (bellows pad)
 - 2) Weakening of the rubber parts (skirt of the adsorption surface, bending parts, etc.)
 * This may occur at an early stage depending on the operating conditions (high vacuum pressure, suction time [vacuum holding], etc.).
- Decide when to replace the pads, referring to the signs of deterioration, such as changes in the appearance due to wear, reduction in the vacuum pressure, or delay in the transport cycle time.

3 Vacuum Ejector and Vacuum Switching Valve Selection

Formula for Calculating Vacuum Ejector and Switching Valve Size

Average suction flow rate for achieving adsorption response time

$$Q = \frac{V \times 60}{T_1} + Q_L$$

$$T_2 = 3 \times T_1$$

Q: Average suction flow rate [L/min (ANR)]

V: Piping capacity [L]

T₁: Arrival time to stable **P_v** 63% after adsorption [sec]

T₂: Arrival time to stable **P_v** 95% after adsorption [sec]

Q_L: Leakage volume during workpiece adsorption [L/min (ANR)] *1

Max. suction flow rate

$$Q_{max} = (2 \text{ to } 3) \times Q \text{ [L/min (ANR)]}$$

<Selection Procedure>

- **Ejector**
Select an ejector with a maximum suction flow rate greater than the **Q_{max}** indicated above.
- **Direct operation valve**

$$\text{Conductance } C = \frac{Q_{max}}{55.5} \text{ [dm}^3\text{/(s-bar)]}$$

- * Select a valve (solenoid valve) with a conductance that is greater than that of the conductance **C** formula given above from the related equipment (**Web Catalog**).
- *1 **Q_L: 0** when no leakage occurs during workpiece adsorption
If there is leakage during workpiece adsorption, find the leakage volume based on "4. Leakage Volume during Workpiece Adsorption."
- * The tube piping capacity can be found in "3 Data: Piping Capacity by Tube I.D. (Selection Graph (2))."
- * When selecting a ZL series multistage ejector, these details do not apply. Refer to the "Time to Reach Vacuum" graph in the catalog for applicable details.

4 Leakage Volume during Workpiece Adsorption

Air could be drawn in depending on the type of workpiece. As a result, the vacuum pressure in the pads declines and the amount of vacuum that is necessary for adsorption cannot be attained.

When this type of workpiece must be handled, it is necessary to select an ejector and vacuum switching valve of the proper size by taking into consideration the amount of air that could leak through the workpieces.

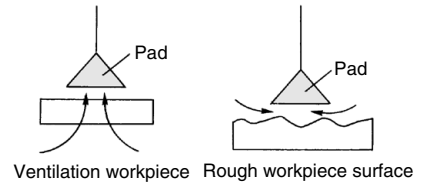

Leakage Volume from Conductance of Workpieces

$$\text{Leakage volume } Q_L = 55.5 \times C_L$$

Q_L: Leakage volume [L/min (ANR)]

C_L: Conductance between workpieces and pads, and workpiece opening area [dm³/(s-bar)]

Leakage Volume from Suction Test

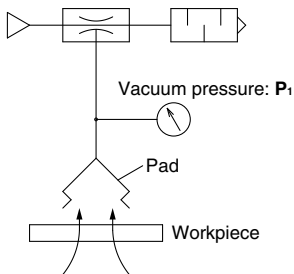

As described in the illustration to the left, adsorb the workpiece with the ejector, using the ejector, pad, and vacuum gauge. At this time, read the vacuum pressure **P₁**, obtain the suction flow rate from the flow rate characteristics graph for the ejector that is being used, and render this amount as the leakage of the workpiece.

Exercise: Using a supply pressure of 0.45 MPa, when the ejector (ZH07□S) adsorbed a workpiece that leaks air, the vacuum gauge indicated a pressure of -53 kPa. Calculate the leakage volume from the workpiece.

<Selection Procedure>

When obtaining the suction flow rate at a vacuum pressure of -53 kPa from the ZH07DS flow rate characteristics graph, the suction flow rate is 5 L/min (ANR). (A→B→C)

$$\text{Leakage volume} \approx \text{Suction flow rate } 5 \text{ L/min (ANR)}$$

ZH07BS, ZH07DS

Exhaust Characteristics

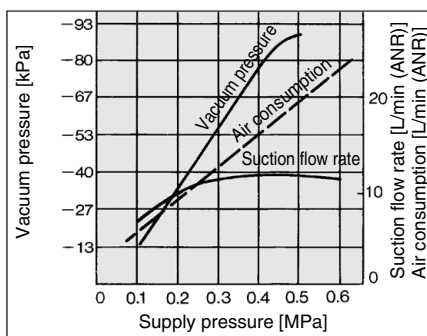

Flow Rate Characteristics

Supply pressure (0.45 MPa)

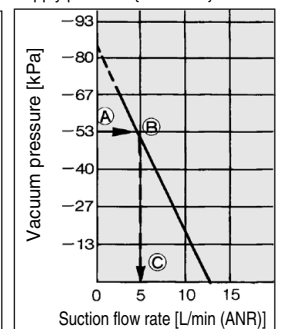

5 Adsorption Response Time

When vacuum pads are used for the adsorption transfer of workpieces, the approximate adsorption response time can be obtained (the length of time it takes for the pads' internal vacuum pressure to reach the pressure that is required for adsorption after the supply valve {vacuum switching valve} has been operated). An approximate adsorption response time can be obtained through formulas and selection graphs.

However, when selecting a ZL series multistage ejector, these details do not apply. Refer to the "Time to Reach Vacuum" graph in the catalog for applicable details.

Relationship between Vacuum Pressure and Response Time after Supply Valve (Switching Valve) is Operated

The relationship between the vacuum pressure and the response time after the supply valve (switching valve) is operated is shown below.

Vacuum System Circuit

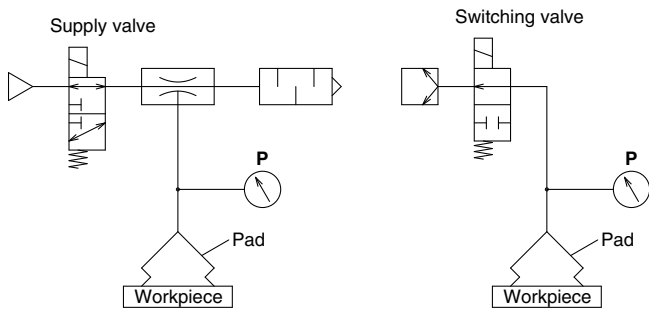

Vacuum Pressure and Response Time after Supply Valve (Switching Valve) is Operated

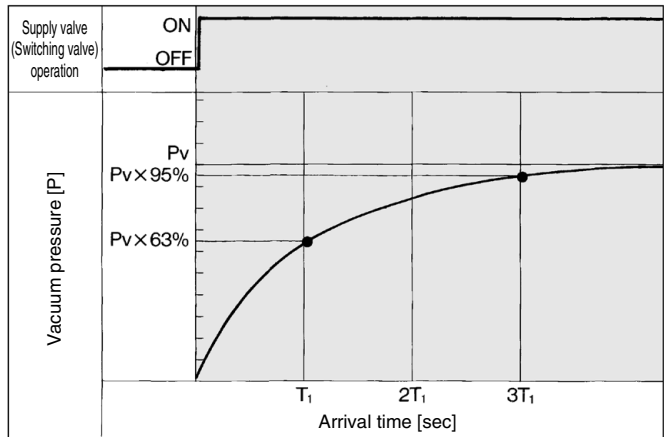

Pv: Final vacuum pressure
T1: Arrival time to 63% of final vacuum pressure **Pv**
T2: Arrival time to 95% of final vacuum pressure **Pv**

Formula for Calculating Adsorption Response Time

Adsorption response times **T1** and **T2** can be obtained through the formulas given below.

<p>Adsorption response time $T_1 = \frac{V \times 60}{Q}$</p> <p>Adsorption response time $T_2 = 3 \times T_1$</p> <p>Piping capacity</p> $V = \frac{3.14}{4} D^2 \times L \times \frac{1}{1000} \text{ [L]}$	<p>T1: Arrival time to 63% of final vacuum pressure Pv [sec] T2: Arrival time to 95% of final vacuum pressure Pv [sec] Q1: Average suction flow rate [L/min (ANR)]</p> <p>Calculation of average suction flow rate</p> <ul style="list-style-type: none"> • Ejector $Q_1 = (1/2 \text{ to } 1/3) \times \text{Ejector max. suction flow rate [L/min (ANR)]}$ • Vacuum pump $Q_1 = (1/2 \text{ to } 1/3) \times 55.5 \times \text{Conductance of switching valve [dm}^3\text{/(s}\cdot\text{bar)]}$ <p>D: Piping diameter [mm] L: Length from ejector and switching valve to pad [m] V: Piping capacity from ejector and switching valve to pad [L] Q2: Max. flow from ejector and switching valve to pad by piping system $Q_2 = C \times 55.5 \text{ L/min (ANR)}$ Q: Smaller one between the Q1 and Q2 [L/min (ANR)] C: Conductance of piping [dm³/(s·bar)]</p>
--	--

For the conductance, the equivalent conductance can be found in "8 Data: Conductance by Tube I.D. (Selection Graph (3))."

■ Adsorption Response Time from the Selection Graph

1. Tube Piping Capacity

The piping capacity from the ejector and the switching valve of the vacuum pump system to the pad can be found in “**3** Data: Piping Capacity by Tube I.D. (Selection Graph (2)).”

2. Obtain the adsorption response times.

By operating the supply valve (switching valve) that controls the ejector (vacuum pump), the adsorption response times T_1 and T_2 that elapsed before the prescribed vacuum pressure is reached can be obtained from Selection Graph (1).

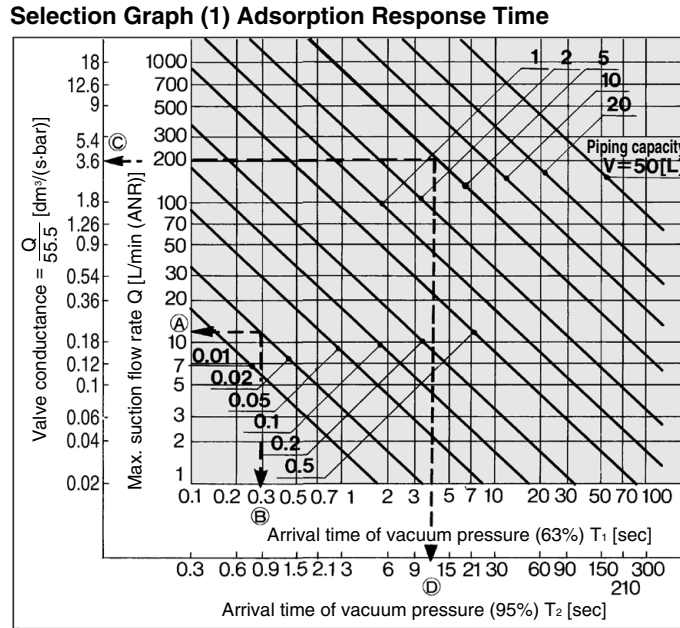

* Conversely, the size of the ejector or the size of the switching valve of the vacuum pump system can be obtained from the adsorption response time.

How to read the graph

Example 1: For obtaining the adsorption response time until the pressure in the piping system with a piping capacity of 0.02 L is discharged to 63% (T_1) of the final vacuum pressure through the use of a ZH07□S vacuum ejector with a maximum suction flow rate of 12 L/min (ANR)

<Selection Procedure>

From the point at which the vacuum ejector's maximum vacuum suction flow rate of 12 L/min (ANR) and the piping capacity of 0.02 L intersect, the adsorption response time T_1 that elapses until 63% of the maximum vacuum pressure is reached can be obtained. (Sequence in Selection Graph (1), (A)→(B)) $T_1 \approx 0.3$ seconds

Example 2: For obtaining the discharge response time until the internal pressure in the 5 L tank is discharged to 95% (T_2) of the final vacuum pressure through the use of a valve with a conductance of 3.6 dm³/(s·bar)

<Selection Procedure>

From the point at which the valve's conductance of 3.6 dm³/(s·bar) and the piping capacity of 5 L intersect, the discharge response time (T_2) that elapses until 95% of the final vacuum pressure is reached can be obtained. (Sequence in Selection Graph (1), (C)→(D)) $T_2 \approx 12$ seconds

6 Precautions for Vacuum Equipment Selection and SMC's Proposals

Safety Measures

- Make sure to provide a safe design that takes into account vacuum pressure drops caused by power supply disruptions or a lack of supply air. Drop prevention measures must be taken in particular when the dropping of workpieces presents some degree of danger.

Precautions for Vacuum Equipment Selection

As a countermeasure for power outages, select a supply valve that is normally open or one that is equipped with a self-holding function.

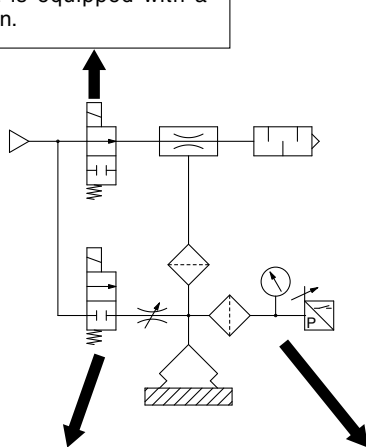

Be aware that the composite conductance consisting of the areas from the pad to the ejector of a vacuum switching valve does not decrease.

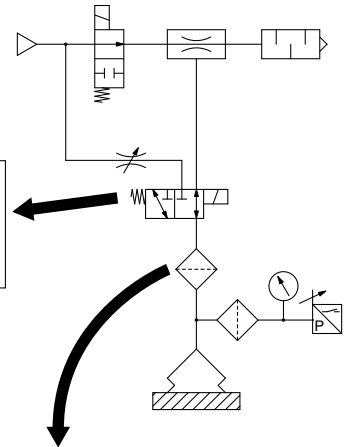

For the release valve, select a 2/3-port valve with a low-vacuum specification. Also, use a needle valve to regulate the release flow rate.

- During the adsorption and transfer of workpieces, checking of the vacuum switch values is recommended.
- In addition, visually check the vacuum gauge values when handling a heavy or a hazardous item.
- Install a filter (ZFA, ZFB, ZFC series) before the pressure switch if the ambient air is of low quality.

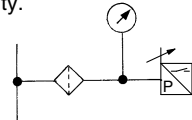

Use a suction filter (ZFA, ZFB, ZFC series) to protect the switching valve and to prevent the ejector from becoming clogged. Also, a suction filter must be used in dusty environments. If only the unit's filter is used, it will become clogged quickly.

Vacuum Ejector or Pump and Number of Vacuum Pads

Ejector and number of pads		Vacuum pump and number of pads	
Ideally, one pad should be used for each ejector.	When more than one pad is attached to a single ejector, if one of the workpieces becomes detached, the vacuum pressure will drop, causing the other workpieces to become detached. Therefore, the countermeasures listed below must be taken. <ul style="list-style-type: none"> • Adjust the needle valve to minimize the pressure fluctuation between adsorption and non-adsorption operations. • Provide a vacuum switching valve to each individual pad to minimize the influence on other pads if an adsorption error occurs. 	Ideally, one pad should be used for each line.	When more than one pad is attached to a single vacuum line, take the countermeasures listed below. <ul style="list-style-type: none"> • Adjust the needle valve to minimize the pressure fluctuation between adsorption and non-adsorption operation. • Include a tank and a vacuum pressure reduction valve (vacuum pressure regulator valve) to stabilize the source pressure. • Provide a vacuum switching valve to each individual pad to minimize the influence on other pads if an adsorption error occurs.

Vacuum Ejector Selection and Handling Precautions

Ejector Selection

There are 2 types of ejector flow rate characteristics: the high-vacuum type (S type) and the high-flow type (L type). During selection, pay particular attention to the vacuum pressure when adsorbing workpieces that leak.

High Vacuum Type Flow Rate Characteristics/ ZH13□S

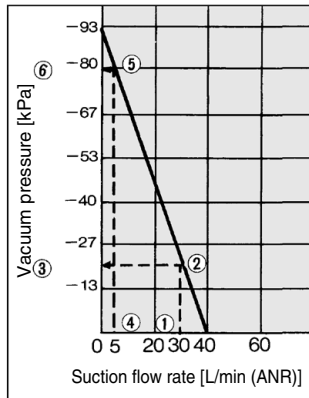

High Flow Type Flow Rate Characteristics/ ZH13□L

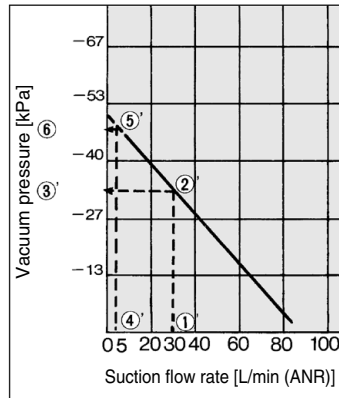

The vacuum pressure varies in accordance with the leakage volumes indicated in the above diagrams.

If the leakage volume is 30 L/min (ANR), the vacuum pressure of the S type is -20 kPa ① → ② → ③, and for the L type it is -33 kPa ①' → ②' → ③'. If the leakage volume is 5 L/min (ANR), the vacuum pressure of the S type is -80 kPa ④ → ⑤ → ⑥, and for the L type it is -47 kPa ④' → ⑤' → ⑥'. Thus, if the leakage volume is 30 L/min (ANR), the L type can attain a higher vacuum pressure, and if the leakage volume is 5 L/min (ANR), the S type can attain a higher vacuum pressure.

Thus, during the selection process, make sure to take the flow rate characteristics of the high-vacuum type (S type) and the high-flow type (L type) into consideration in order to select the type that is optimal for your application.

Ejector Nozzle Diameter Selection

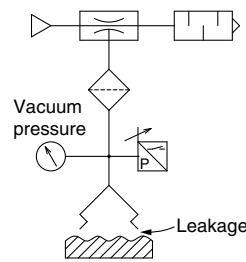

If a considerable amount of leakage occurs between the workpieces and the pads, resulting in incomplete adsorption, or to shorten the adsorption and transfer time, select an ejector nozzle with a larger diameter from the ZH, ZR, or ZL series.

Manifold Use

Individual exhaust

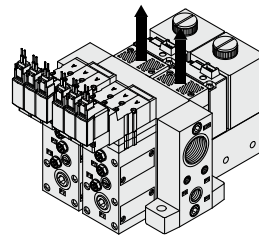

If there are a large number of ejectors that are linked on a manifold and operated simultaneously, use the built-in silencer type or the port exhaust type.

Centralized exhaust

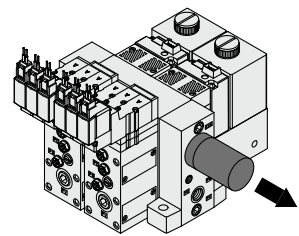

If there are a large number of ejectors that are linked on a manifold, which exhaust collectively, install a silencer at both ends. If the exhaust must be discharged outdoors through piping, make the diameter of the piping larger to control its back pressure to 5 kPa or less so that the back pressure will not affect the operation of the ejectors.

- If the vacuum ejector makes an intermittent noise (abnormal noise) from the exhaust at a certain supply pressure, the vacuum pressure may not be stable. No problems should arise from using the vacuum ejector in this state. However, if the noise is disturbing or affects the operation of the vacuum pressure switch, lower or raise the supply pressure a little at a time, and use within an air pressure range that does not produce the intermittent noise.

Supply Pressure of Vacuum Ejector

- It is recommended to use the vacuum ejector at the standard supply pressure. The maximum vacuum pressure and suction flow rate can be obtained when the vacuum ejector is used at the standard supply pressure, and as a result, the adsorption response time also improves. From the viewpoint of energy saving, it is most effective to use the ejector at the standard supply pressure. Since using it at an excessive supply pressure may cause the ejector performance to decline, it is recommended that it be used at the standard supply pressure.

■ Timing for Vacuum Generation and Suction Verification

A. Timing for Vacuum Generation

The time for opening/closing the valve will be counted if vacuum is generated after the adsorption pad descends to adsorb a workpiece. Also, there may be a delay in the generation of vacuum since the operational pattern of the verification switch, which is used for detecting the descending vacuum pad, is varied.

To solve this issue, we recommend that vacuum be generated in advance, before the vacuum pads begin to descend to the workpieces. Adopt this method after confirming that there will be no misalignment resulting from the workpieces' light weight.

B. Suction Verification

When lifting a vacuum pad after adsorbing a workpiece, confirm that there is a suction verification signal from the vacuum pressure switch before the vacuum pad is lifted. If the vacuum pad is lifted based on the timing of a timer, etc., the workpiece may be left behind.

In general adsorption transfer, the time for adsorbing a workpiece is slightly different since the position of the vacuum pad and the workpiece are different after every operation. Therefore, program a sequence in which the suction completion is verified by a vacuum pressure switch, etc., before moving to the next operation.

C. Set Pressure for the Vacuum Pressure Switch

Set the optimum value after calculating the required vacuum pressure for lifting workpieces.

If a higher pressure than required is set, there is a possibility of being unable to confirm the suction even though a workpiece is being adsorbed. This will result in a suction error.

When setting vacuum pressure switch set values, you should set using a lower pressure, with which workpieces can be adsorbed, only after considering the acceleration or vibration when the workpieces are transferred. The set value of the vacuum pressure switch shortens the time required to lift the workpieces. Since a switch detects whether a workpiece is being lifted or not, the pressure must be set high enough to detect it.

Vacuum Pressure Switch (ZSE series) Flow Sensor (PFMV series) Vacuum Pressure Gauge (GZ series)

When adsorbing and transferring workpieces, check the vacuum pressure switch values as much as possible. (In addition, visually check the vacuum gauge values, especially when handling a heavy or hazardous item.)

Approx. ø1 adsorption nozzle

The difference in pressure between ON and OFF is reduced depending on the capacity of the ejector and the vacuum pump.

In such cases, it is necessary to use a **ZSE10 or ZSE30A digital pressure switch with a fine smallest settable increment or a flow switch for flow rate detection.**

- * • A vacuum generator with a large suction capacity will not be detected properly, so an ejector with an appropriate capacity must be selected.
- Since the hysteresis is small, vacuum pressure must be stabilized.

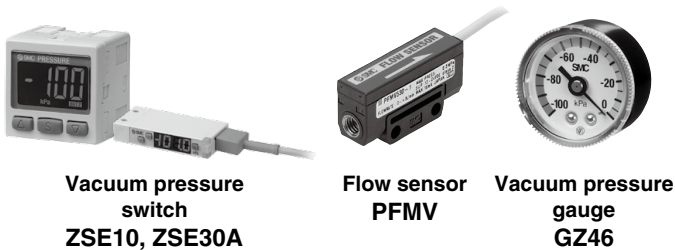

Refer to the [Web Catalog](#) for details.

Timing Chart Example

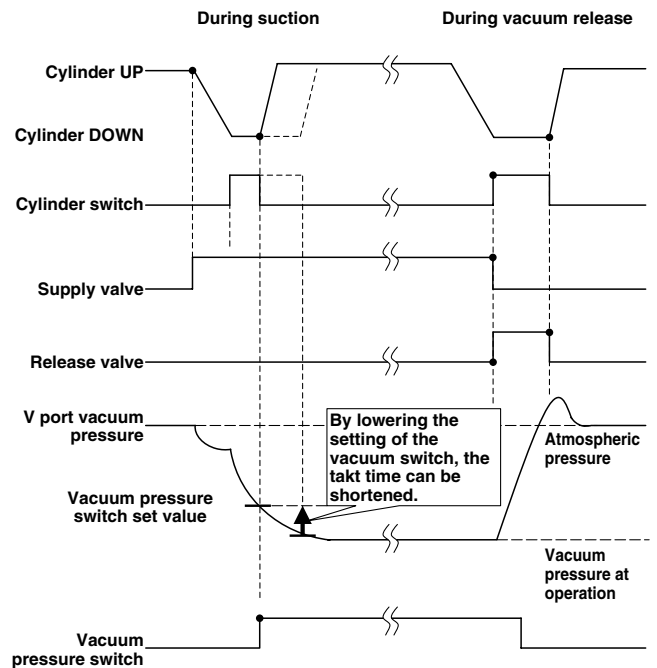

Dust and Vacuum Equipment

- When vacuum equipment is used, not only the workpieces but also the dust in the surrounding environment is taken into the equipment. Preventing the intrusion of dust is more important for vacuum equipment than it is for any other kind of pneumatic equipment. Some of SMC's vacuum equipment comes with a filter, but when there is a large amount of dust, an additional filter must be installed.
- When vaporized materials such as oil or adhesive are sucked into the equipment, they accumulate inside, which may cause problems.
- It is important to prevent dust from entering the vacuum equipment as much as possible.
 - (1) Make sure to keep the working environment and the surrounding area of the workpieces clean so that dust will not be sucked into the equipment.
 - (2) Check the amount and types of dust before using the equipment and install a filter, etc., in the piping when necessary.
 - (3) Conduct a test and make sure that operating conditions are cleared before using the equipment.
 - (4) Perform filter maintenance according to how dirty the filter becomes.
 - (5) Filter clogging generates a pressure difference between the adsorption and ejector parts. This requires attention since clogging can prevent proper adsorption from being achieved.

Air Suction Filter (ZFA, ZFB, ZFC series)

- To protect the switching valve and the ejector from becoming clogged, a suction filter in the vacuum circuit is recommended.
- When using an ejector in dusty environments, the unit's filter will become clogged quickly, so it is recommended that a ZFA, ZFB, or ZFC series filter be used concurrently.

Vacuum Line Equipment Selection

Determine the volume of the suction filter and the conductance of the switching valve in accordance with the maximum suction flow rate of the ejector and the vacuum pump. Make sure that the conductance is greater than the value that has been obtained through the formula given below. (If the devices are connected in series in the vacuum line, their conductance values must be combined.)

$$C = \frac{Q_{\max}}{55.5}$$

C: Conductance [dm³/(s·bar)]
Q_{max}: Max. suction flow rate [L/min (ANR)]

7 Vacuum Equipment Selection Example

Transfer of Semiconductor Chips

Selection conditions

- (1) Workpiece: Semiconductor chips, Dimensions: 8 mm x 8 mm x 1 mm, Weight: 1 g
- (2) Vacuum piping length: 1 m
- (3) Adsorption response time: 300 ms or less

1. Vacuum Pad Selection

- (1) Based on the workpiece size, the pad diameter is 4 mm (1 pc.).
- (2) Using the formula on page 7, check the lifting force.

$$\begin{array}{l}
 \mathbf{W = P \times S \times 0.1 \times 1/t} \\
 \mathbf{0.0098 = P \times 0.13 \times 0.1 \times 1/4} \\
 \mathbf{P = 3.0 \text{ kPa}}
 \end{array}
 \quad
 \left\{
 \begin{array}{l}
 \mathbf{W = 1 \text{ g} = 0.0098 \text{ N}} \\
 \mathbf{S = \pi/4 \times (0.4)^2 = 0.13 \text{ cm}^2} \\
 \mathbf{t = 4 \text{ (Horizontal lifting)}}
 \end{array}
 \right.$$

According to the calculation, -3.0 kPa or more of vacuum pressure can adsorb the workpieces.

- (3) Based on the workpiece shape and type, select:
 Pad form: Flat type with groove
 Pad material: Silicone rubber
- (4) According to the results above, select the vacuum pad part number ZP3-04UMS.

2. Vacuum Ejector Selection

- (1) Find the vacuum piping capacity.
 Assuming that the tube I.D. is 2 mm, the piping capacity is as follows:

$$\mathbf{V = \pi/4 \times D^2 \times L \times 1/1000 = \pi/4 \times 2^2 \times 1 \times 1/1000} \\
 \mathbf{= 0.0031 \text{ L}}$$
- (2) Assuming that leakage (Q_L) during adsorption is 0, find the average suction flow rate to meet the adsorption response time using the formula on page 12.

$$\mathbf{Q = (V \times 60) / T_1 + Q_L = (0.0031 \times 60) / 0.3 + 0 = 0.62 \text{ L}}$$

From the formula on page 12, the maximum suction flow rate Q_{max} is

$$\mathbf{Q_{max} = (2 \text{ to } 3) \times Q = (2 \text{ to } 3) \times 0.62} \\
 \mathbf{= 1.24 \text{ to } 1.86 \text{ L/min (ANR)}}$$

According to the maximum suction flow rate of the vacuum ejector, a nozzle with a 0.5 diameter can be used. If a ZX series vacuum ejector is used, the ZX105□ representative model can be selected. (Based on the operating conditions, specify the complete part number for the vacuum ejector to be used.)

3. Adsorption Response Time Confirmation

Confirm the adsorption response time based on the characteristics of the vacuum ejector selected.

- (1) The maximum suction flow rate of the ZX105□ vacuum ejector is 5 L/min (ANR).
 From the formula on page 13, the average suction flow rate Q_1 is as follows:

$$\mathbf{Q_1 = (1/2 \text{ to } 1/3) \times \text{Ejector max. suction flow rate}} \\
 \mathbf{= (1/2 \text{ to } 1/3) \times 5 = 2.5 \text{ to } 1.7 \text{ L/min (ANR)}}$$

- (2) Next, find the maximum flow rate Q_2 of the piping. The conductance C is 0.22 from Selection Graph (3).
 From the formula on page 13, the maximum flow rate is as follows:

$$\mathbf{Q_2 = C \times 55.5 = 0.22 \times 55.5 = 12.2 \text{ L/min (ANR)}}$$

- (3) Since Q_2 is smaller than Q_1 , $Q = Q_1$.

Thus, from the formula on page 13, the adsorption response time is as follows:

$$\mathbf{T = (V \times 60)/Q = (0.0031 \times 60)/1.7 = 0.109 \text{ s}} \\
 \mathbf{= 109 \text{ ms}}$$

It is possible to confirm that the calculation result satisfies the required specification of 300 ms.

8 Data

Selection Graph

Selection Graph (2) Piping Capacity by Tube I.D.

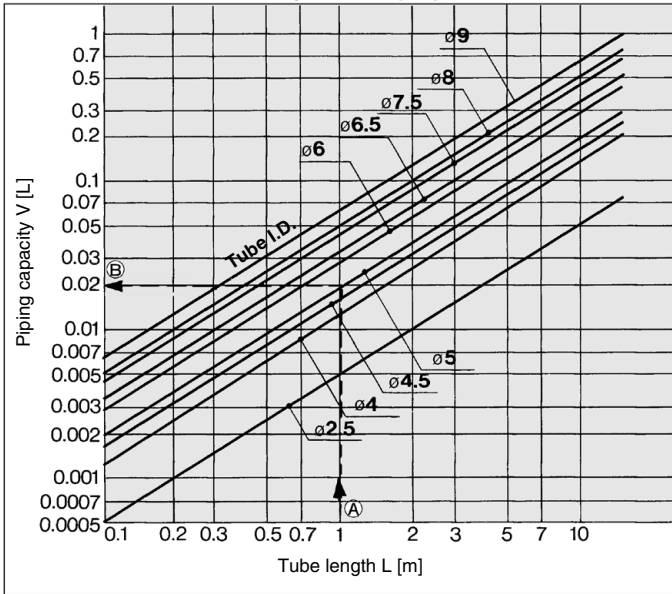

How to read the graph

Example: For obtaining the capacity of a tube with an I.D. of ø5 and a length of 1 meter

<Selection Procedure>

By extending leftward from the point at which the 1 meter tube length on the horizontal axis intersects the line for a tube with an I.D. of ø5, a piping capacity approximately equivalent to 0.02 L can be obtained on the vertical axis.

Piping capacity ≈ 0.02 L

Selection Graph (3) Conductance by Tube I.D.

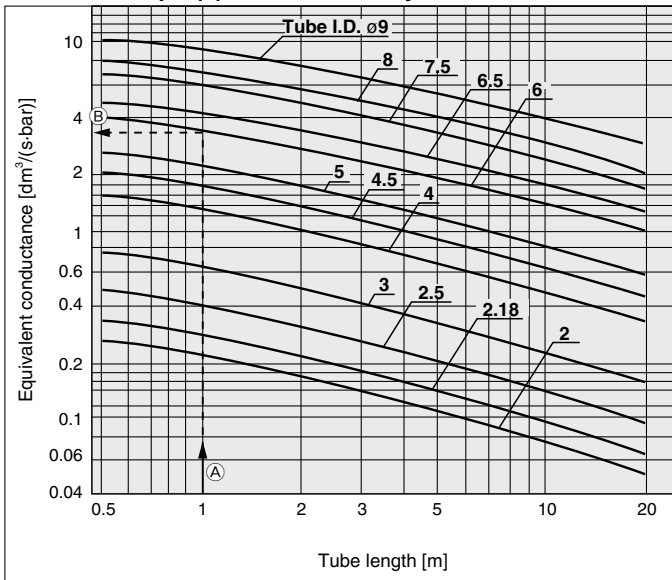

How to read the graph

Example: A ø8/ø6 sized tube with a length of 1 meter

<Selection Procedure>

By extending leftward from the point at which the 1 meter tube length on the horizontal axis intersects the line for a tube with an I.D. of ø6, an equivalent conductance of approximately 3.6 dm³/(s·bar) can be obtained on the vertical axis.

Equivalent conductance ≈ 3.6 dm³/(s·bar)

Glossary of Terms

Terms	Description
(Max.) suction flow rate	Volume of air taken in by the ejector The maximum value is the volume of air taken in without having anything connected to the vacuum port.
Maximum vacuum pressure	The maximum value of the vacuum pressure generated by the ejector
Air consumption	The compressed volume of air consumed by the ejector
Standard supply pressure	The optimal supply pressure for operating the ejector
Exhaust characteristics	The relationship between the vacuum pressure and the suction flow rate when the supply pressure to the ejector has been changed
Flow rate characteristics	The relationship between the vacuum pressure and the suction flow rate with the standard supply pressure supplied to the ejector
Vacuum pressure switch	Pressure switch for verifying the adsorption of a workpiece
(Air) supply valve	Valve for supplying compressed air to the ejector
(Vacuum) release valve	Valve for supplying positive pressure or air for breaking the vacuum state of the adsorption pad
Flow adjustment valve	Valve for adjusting the volume of air for breaking the vacuum
Pilot pressure	Pressure for operating the ejector valve
External release	The action of breaking the vacuum using externally supplied air instead of using the ejector unit
Vacuum port	Port for generating vacuum
Exhaust port	Port for exhausting air consumed by the ejector, and air taken in from the vacuum port
Supply port	Port for supplying air to the ejector
Back pressure	Pressure inside the exhaust port
Leakage	The entry of air into the vacuum passage, such as from an area between a workpiece and a pad, or between a fitting and a tube The vacuum pressure decreases when leakage occurs.
Response time	The time from the application of the rated voltage to the supply valve or release valve until the V port pressure reaches the specified pressure
Average suction flow rate	The suction flow rate by the ejector or pump for calculating the response speed It is 1/2 to 1/3 of the maximum suction flow rate.
Conductive pad	A low-electrical resistance pad for electrostatic prevention
Vacuum pressure	Any pressure below the atmospheric pressure When the atmospheric pressure is used as a reference, the pressure is represented by -kPa (G), and when the absolute pressure is used as a reference, the pressure is represented by kPa (abs). When referencing a piece of vacuum equipment such as an ejector, the pressure is generally represented by -kPa.
Ejector	A unit for generating vacuum by discharging the compressed air from a nozzle at a high speed, which is based on the phenomenon in which the pressure is reduced when the air around the nozzle is sucked in
Air suction filter	Vacuum filter provided in the vacuum passage for preventing the intrusion of dust into the ejector, vacuum pump, or peripheral equipment

Countermeasures for Vacuum Adsorption Problems (Troubleshooting)

Condition & Description of improvement	Contributing factor	Countermeasure
Initial adsorption problem (During trial operation)	The adsorption area is too small. (The lifting force is lower than the workpiece mass.)	Recheck the relationship between the workpiece mass and the lifting force. <ul style="list-style-type: none"> • Use vacuum pads with a larger adsorption area. • Increase the quantity of vacuum pads.
	The vacuum pressure is too low. (Leakage from adsorption surface) (Air permeable workpiece)	Eliminate (reduce) the leakage from the adsorption surface. <ul style="list-style-type: none"> • Reconsider the form of the vacuum pads. Check the relationship between the suction flow rate and the arrival pressure of the vacuum ejector. <ul style="list-style-type: none"> • Use a vacuum ejector with a high suction flow rate. • Increase the adsorption area.
	The vacuum pressure is too low. (Leakage from vacuum piping)	Repair the leakage point.
	The internal volume of the vacuum circuit is too large.	Check the relationship between the internal volume of the vacuum circuit and the suction flow rate of the vacuum ejector. <ul style="list-style-type: none"> • Reduce the internal volume of the vacuum circuit. • Use a vacuum ejector with a high suction flow rate.
	The pressure drop in the vacuum piping is too large.	Reconsider the vacuum piping. <ul style="list-style-type: none"> • Use a shorter or larger tube (of an appropriate diameter).
	Inadequate supply pressure of vacuum ejector	Measure the supply pressure in a vacuum generation state. <ul style="list-style-type: none"> • Use the standard supply pressure. • Reconsider the compressed air circuit (line).
	Clogging of nozzle or diffuser (Infiltration of foreign matter during piping)	Remove foreign matter.
	The supply valve (switching valve) is not being activated.	Measure the supply voltage at the solenoid valve with a tester. <ul style="list-style-type: none"> • Reconsider the electric circuits, wiring, and connectors. • Use within the rated voltage range.
	The workpieces become deformed during adsorption.	Since the workpieces are thin, they become deformed easily and leakage occurs. <ul style="list-style-type: none"> • Use pads for the adsorption of thin objects.
Slow vacuum achieving time (Shortening of response time)	The internal volume of the vacuum circuit is too large.	Check the relationship between the internal volume of the vacuum circuit and the suction flow rate of the vacuum ejector. <ul style="list-style-type: none"> • Reduce the internal volume of the vacuum circuit. • Use a vacuum ejector with a high suction flow rate.
	The pressure drop in the vacuum piping is too large.	Reconsider the vacuum piping. <ul style="list-style-type: none"> • Use a shorter or larger tube (of an appropriate diameter).
	The vacuum pressure required is too high.	Set the vacuum pressure to the minimum necessary value by optimizing the pad diameter, etc. As the vacuum power of an ejector (venturi) rises, the vacuum flow actually lowers. When an ejector is used at its highest possible vacuum value, the vacuum flow will lower. Due to this, the amount of time needed to achieve adsorption increases. One should consider an increase in the diameter of the ejector nozzle or an increase in the size of the vacuum pads utilized in order to lower the required vacuum pressure, maximize the vacuum flow, and speed up the adsorption process.
	The setting of the vacuum pressure switch is too high.	Set to a suitable setting pressure.
Fluctuation in vacuum pressure	Fluctuation in supply pressure	Reconsider the compressed air circuit (line). (Addition of a tank, etc.)
	The vacuum pressure fluctuates under certain conditions due to the ejector characteristics.	Lower or raise the supply pressure a little at a time, and use within a supply pressure range where the vacuum pressure does not fluctuate.
Occurrence of abnormal noise (intermittent noise) from exhaust of vacuum ejector	An intermittent noise occurs under certain conditions due to the ejector characteristics.	Lower or raise the supply pressure a little at a time, and use within a supply pressure range where the intermittent noise does not occur.
Air leakage from vacuum port of manifold type vacuum ejector	Exhaust air from the ejector enters the vacuum port of another ejector that is stopped.	Use a vacuum ejector with a check valve. (Please contact SMC for the part number of an ejector with a check valve.)

Countermeasures for Vacuum Adsorption Problems (Troubleshooting)

Condition & Description of improvement	Contributing factor	Countermeasure
Adsorption problem over time (Adsorption is normal during trial operation.)	Clogging of suction filter	Replace the filters. Improve the installation environment.
	Clogging of sound absorbing material	Replace the sound absorbing materials. Add a filter to the supply (compressed) air circuit. Install an additional suction filter.
	Clogging of nozzle or diffuser	Remove foreign matter. Add a filter to the supply (compressed) air circuit. Install an additional suction filter.
	Vacuum pad (rubber) deterioration, cracking, etc.	Replace the vacuum pads. Check the compatibility between the vacuum pad material and the workpieces.
Workpieces are not released.	Inadequate release flow rate	Open the release flow adjustment needle.
	The vacuum pressure is too high. Excessive force (adhesiveness of the rubber + vacuum pressure) is applied to the pads (rubber part).	Reduce the vacuum pressure. If inadequate lifting force causes a problem in transferring the workpieces, increase the number of pads.
	Effects due to static electricity	Use conductive pads.
	The adhesiveness of the rubber increases due to the operating environment or wearing of the pad. • The adhesiveness of the rubber material is too high. • The adhesiveness increases due to the wearing of the vacuum pads (rubber).	Replace the pads. Reconsider the pad material and check the compatibility between the pad material and the workpieces. Reconsider the pad form. (Change to rib, groove, blast options) Reconsider the pad diameter and quantity of pads.

Examples of Non-conformance

Phenomenon	Possible causes	Countermeasure
No problem occurs during the test, but adsorption becomes unstable after starting operation.	<ul style="list-style-type: none"> The setting of the vacuum switch is not appropriate. The supply pressure is unstable. The vacuum pressure does not reach the set pressure. There is leakage between the workpieces and the vacuum pads. 	<ol style="list-style-type: none"> Set the pressure for the vacuum equipment (supply pressure, if using an ejector) to the necessary vacuum pressure during the adsorption of the workpieces. And set the set pressure for the vacuum switch to the necessary vacuum pressure for adsorption. It is presumed that there was leakage during the test, but it was not serious enough to prevent adsorption. Reconsider the vacuum ejector and the form, diameter, and material of the vacuum pads. Reconsider the vacuum pads.
Adsorption becomes unstable after replacing the pads.	<ul style="list-style-type: none"> The initial setting conditions (vacuum pressure, vacuum switch setting, height of the pads) have changed. The settings have changed because the pads were worn out due to the operating environment. When the pads were replaced, leakage was generated from the screw connection part or the engagement between the pad and the adapter. 	<ol style="list-style-type: none"> Reconsider the operating conditions including vacuum pressure, the set pressure of the vacuum switch, and the height of the pads. Reconsider the engagement.
Identical pads are used to adsorb identical workpieces, but some of the pads cannot adsorb the workpieces.	<ul style="list-style-type: none"> There is leakage between the workpieces and the vacuum pads. The supply circuit for the cylinder, the solenoid valve, and the ejector are in the same pneumatic circuit system. The supply pressure decreases when they are used simultaneously. (Vacuum pressure does not increase.) There is leakage from the screw connection part or the engagement between the pad and the adapter. 	<ol style="list-style-type: none"> Reconsider the pad diameter, form, material, vacuum ejector (suction flow rate), etc. Reconsider the pneumatic circuit. Reconsider the engagement.
The bellows of the bellows pad sticks and/or there are recovery delays. (This may occur at an early stage.)	<p>When the vacuum pad (bellows type) reaches the end of its life, the weakening of bent parts or the wear or sticking of rubber parts may occur.</p>	<p>The operating conditions will determine the product life. Inspect it sufficiently and determine the replacement period.</p> <ul style="list-style-type: none"> Replace the pads. Reconsider the diameter, form, and material of the vacuum pads. Reconsider the quantity of the vacuum pads.
	<p>The vacuum pressure is higher than necessary, so excessive force (adhesiveness of the rubber + vacuum pressure) is applied to the pads (rubber part).</p>	<p>Reduce the vacuum pressure. If an inadequate lifting force causes a problem in transferring the workpieces due to the reduction of vacuum pressure, increase the number of pads.</p>
	<p>A load is applied to the bellows due to the following operations, leading to the sticking of rubber parts or a reduction of the pad recovery performance.</p> <ul style="list-style-type: none"> Pushing exceeding pad displacement (operating range), external load Workpiece holding/waiting Waiting 10 seconds or more while a workpiece is being held <p>* Even when under 10 seconds, the sticking of pads or recovery delay issues may occur earlier depending on the operating environment and operating method. Longer workpiece holding times lead to longer recovery times and a shorter life.</p>	<p>Reduce the load applied to the pads.</p> <ul style="list-style-type: none"> Review the equipment so that an external load exceeding the pad displacement (operating range) is not applied. Avoid workpiece holding and waiting. <p>The operating conditions will determine the product life. Inspect it and determine the replacement period.</p>
The product life has been shortened after the replacement of the product (pad, buffer, etc.).	<ul style="list-style-type: none"> The settings of the product changed. A tube is being pulled. Unbalanced load in the clockwise direction. The transfer speed increased. The workpiece to be transferred was changed. (Shape, center of gravity, weight, etc.) The mounting orientation was at an angle. The operating environment changed. The buffer (mounting nut) was not tightened with the appropriate torque. 	<p>If the problem (inability to adsorb) does not occur when starting the operation, the product may reach the end of its life due to the customer's specification conditions. Reconsider the piping and operation (specifications). The selected model may not be appropriate for the current workpieces to be transferred or for the specifications. Select a different product model by reconsidering the pad form, diameter, quantity, and suction balance.</p>

Examples of Non-conformance

Phenomenon	Possible causes	Countermeasure
<p>The pads come out from the adapter during operation. Cracks are generated on the pads.</p>	<p>A load is applied to the pads (rubber part) due to the following factors.</p> <ul style="list-style-type: none"> • Inadequate lifting force • Incorrect suction balance • Loads due to transfer acceleration were not considered when selecting the product model. 	<p>The selected model may not be appropriate for the current workpieces to be transferred or for the specifications. Select a different product model by reconsidering the pad form, diameter, quantity, and suction balance.</p>
<p>Cracks are generated on the rubber (NBR, conductive NBR).</p> 	<ul style="list-style-type: none"> • The product is operated in an ozone environment. • An ionizer is used. * This phenomenon occurs earlier if pushing or high vacuum pressure is used. 	<p>Reconsider the operating environment. Reconsider the materials to be used.</p>
<p>Even when a mark-free pad is used, the pad end wears out quickly. (Suction marks are generated.)</p>	<p>If the pad adsorbs an extremely clean workpiece, slippage is minimized, and a load (impact) is applied to the pad end.</p>	<p>Use the following products.</p> <ul style="list-style-type: none"> • Fluororesin-coated pad • Clean attachment
<p>Even when a mark-free pad is used, suction marks are generated.</p>	<ul style="list-style-type: none"> • Incorrect application (The mark was generated due to a deformation.) • Contamination (insufficient cleaning) was left on the pad when installing the equipment, dust was present in the operating environment, etc. 	<p>Check the marks generated on the workpieces.</p> <ol style="list-style-type: none"> 1) Marks due to deformed (lined) workpieces Reconsider the pad diameter, form, material, vacuum ejector (suction flow rate), etc. 2) Marks due to worn rubber Reconsider the pad diameter, form, material, vacuum ejector (suction flow rate), etc. 3) Marks generated by moving components If the suction marks disappear or become smaller after wiping with a cloth or waste cloth (without using solutions), clean the pads as they may have been contaminated. Refer to "Cleaning method (Mark-free NBR pad)" in this catalog.
<p>Sometimes the buffer operation is not smooth, or the buffer does not slide.</p>	<p>The tightening torque of the nut for mounting the buffer is outside of the specified range.</p>	<p>Tighten the nut to the recommended tightening torque. Refer to the Specific Product Precautions on pages 165, 198, 246, and 343.</p>
	<p>Particles are stuck to the sliding surface, or it is scratched.</p>	<p>Reconsider the ambient environment.</p>
	<p>A lateral load was applied to the piston rod, causing eccentric wearing.</p>	<p>Review whether a radial load was applied due to piping, etc.</p>

Vacuum Pad Replacement Period

- Vacuum pads are disposable. Replace them on a regular basis.

Continued use of vacuum pads will cause wear and tear on the adsorption surface, and the exterior dimensions will gradually get smaller and smaller. As the pads' diameter gets smaller, their lifting force will decrease, though adsorption will still remain possible.

It is extremely difficult to provide advice on the frequency of vacuum pad replacement. This is because there are numerous factors at work, including surface roughness, operating environment (temperature, humidity, ozone, solvents, etc.), and operating conditions (vacuum pressure, workpiece weight, pressing force of the vacuum pads on the workpieces, presence or absence of a buffer, etc.).

(The weakening of bent parts or the wear or sticking of rubber parts may occur with the bellows type pad.)

Thus, the customer should decide when vacuum pads should be replaced, based on their condition at the time of initial use.

The bolts may become loose depending on the operating conditions and environment. Be sure to perform regular maintenance.