

Air Saving Impact Blow Gun

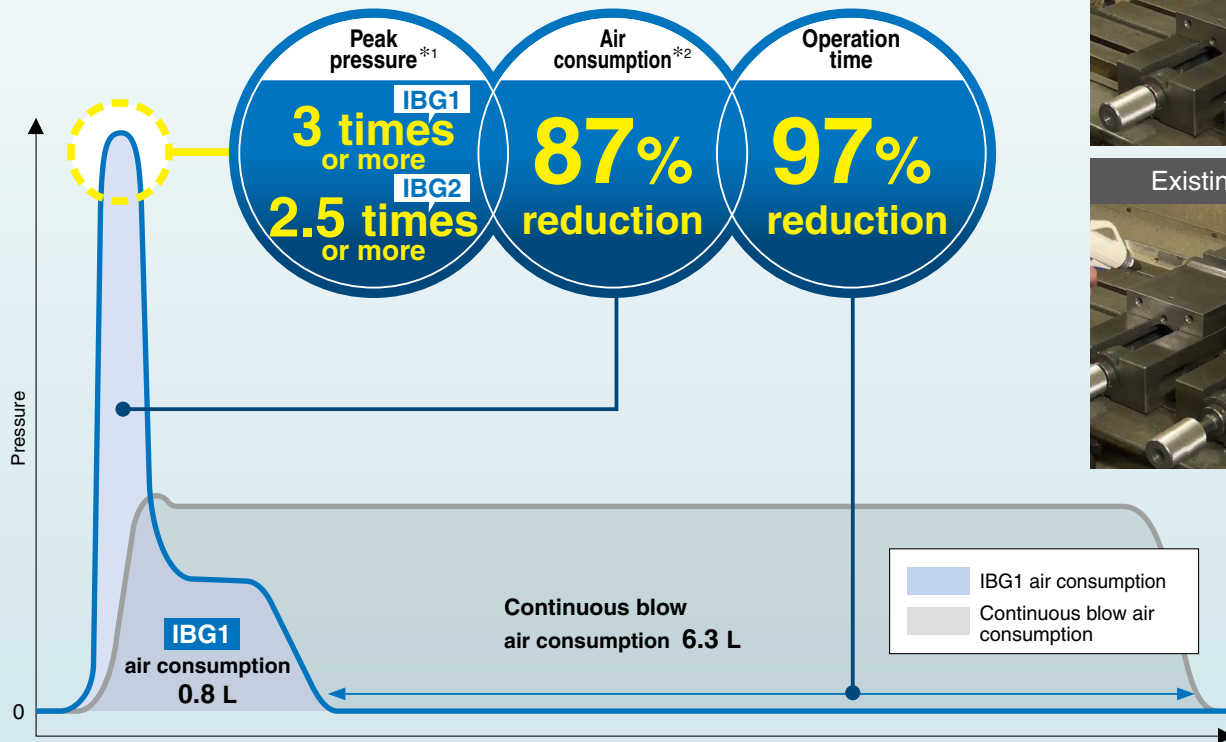

Increased impact force due to higher peak pressure

Instantaneous air blow
reduces air consumption and operation time



Product introduction



Application example video

*1 Compared with the existing model (According to blow conditions) Operation time
*2 Pressure: 0.5 MPa (Based on SMC's specific testing conditions)

High Peak Pressure Type IBG1 Series p. 4



Peak pressure:
3 times or more

New Compact Type IBG2 Series p. 5



Occupied volume:
13% reduction

Lightweight:
21% reduction

IBG Series



CAT.ES50-40B

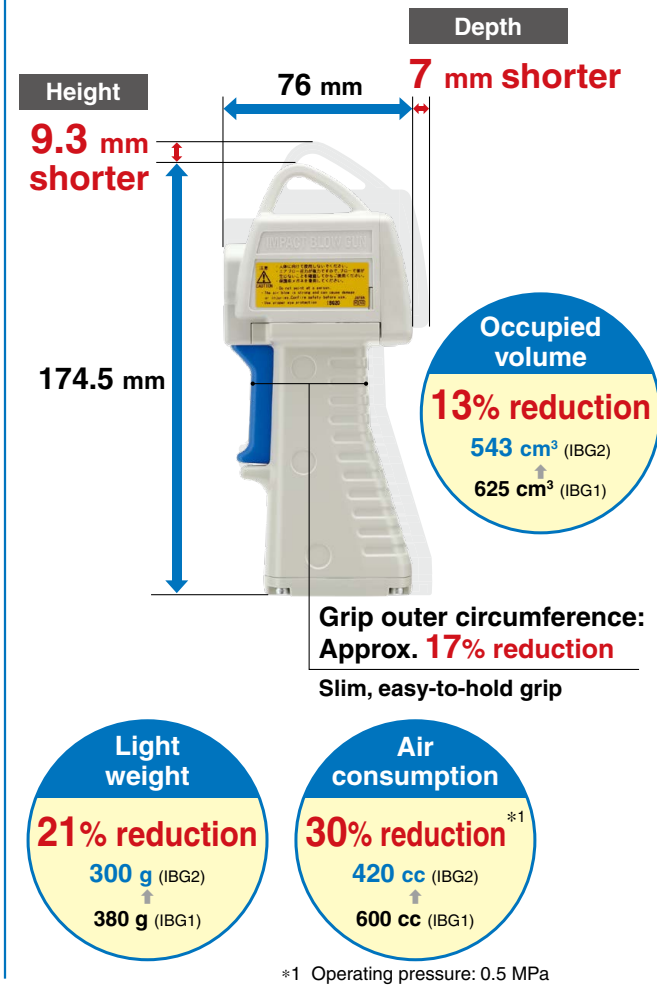

New A compact type has been added.

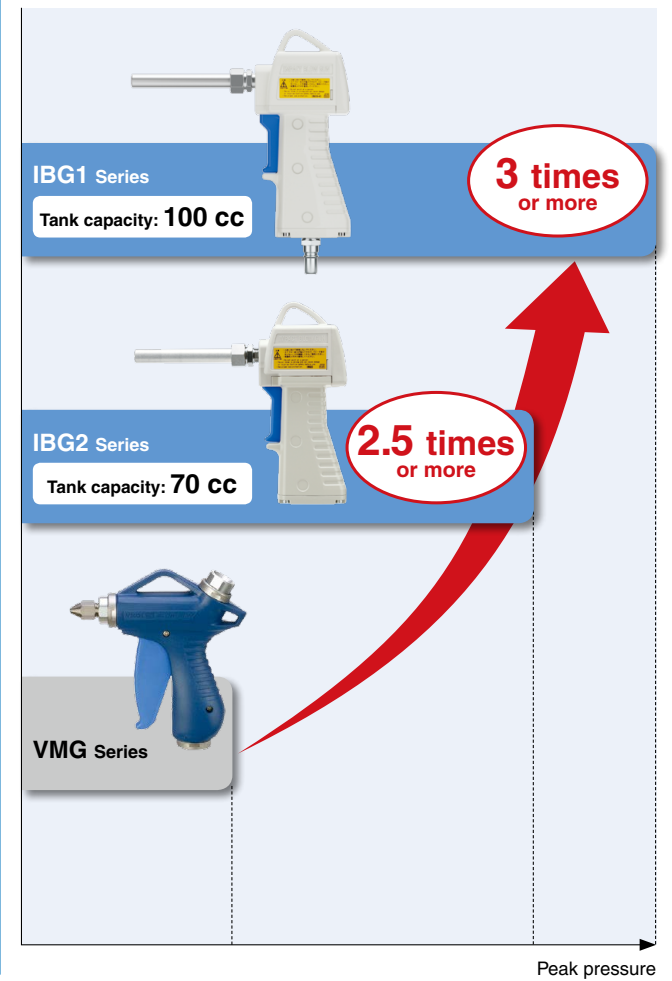

Peak pressure comparison



Variations

Series	Peak pressure*1	Size (Height x Depth x Width) [mm]	Weight [g]	Tank capacity [cc]	Air consumption*2 [cc]	Supply port
High Peak Pressure Type IBG1 Series 	3 times or more	183.8 x 83 x 41	380	100	600	Screw-in type (Rc, NPT, G) 3/8 One-touch fittings ø6 to ø10 ø1/4" to ø3/8" S coupler R3/8
Compact Type IBG2 Series 	2.5 times or more	174.5 x 76 x 41	300	70	420	Screw-in type (Rc, NPT, G) 1/4 One-touch fittings ø6 to ø10 ø1/4" to ø3/8" S coupler R1/4

*1 Compared with the existing VMG series model *2 The amount of air filled in the tank at 0.5 MPa operating pressure

Various Functions

Adjuster with indicator*1

*1 IBG1 only

Quick and simple peak pressure adjustment is possible.



Indicator window	Number of needle rotations
0	0
1	1
2	2
3	3
4	4

Peak pressure and the number of needle rotations
(Supply pressure: 0.5 MPa)

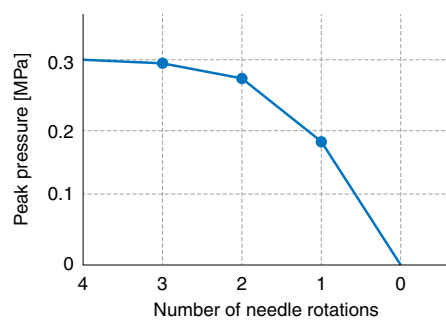

Built-in tank

* Based on SMC's measurement conditions
* Without silencer

Built-in tank provides a stable discharge pressure

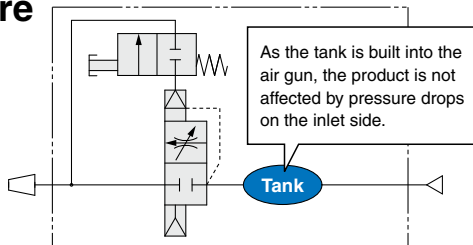

Operational force: 10 N or less

With S coupler/ One-touch fitting

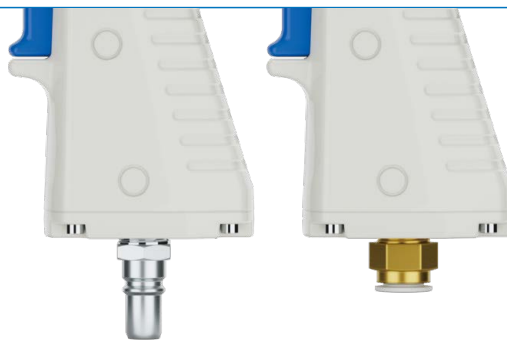

With S coupler

With One-touch fitting

Long nozzle

Nozzle length:
50/100/150/300/
600/1000 mm



Long nozzle with a silencer

80 dB(A) or less

* Based on SMC's measurement conditions



Chip guard

Guards against the blown machining chips and workpiece

* Please order it separately. It is possible to use the guard with a silencer, but in that case, mount the guard before mounting the silencer.

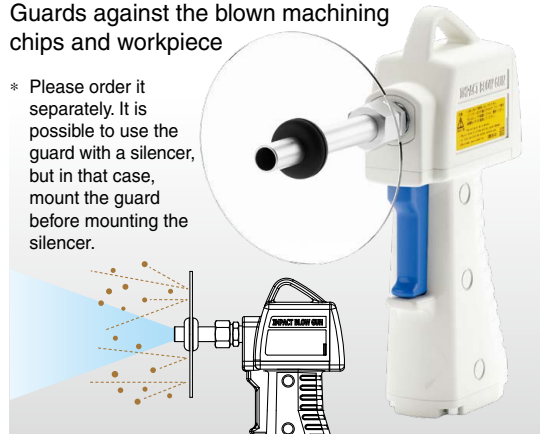

Compliant with OSHA Standards (U.S. Standards)

Silencer	1910.95: Max. noise level 1910.242B: Max. discharge pressure
Chip guard	1910.242B

Related Product

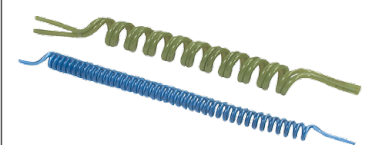

Polyurethane
Coil Tubing
TCU



Application Examples

For the reliable and simple removal of machining chips, foreign matter, and water droplets

Powerful
blow

Reduced
air
consumption

Reduced
operation
time

For the quick removal of machining chips coated with oil

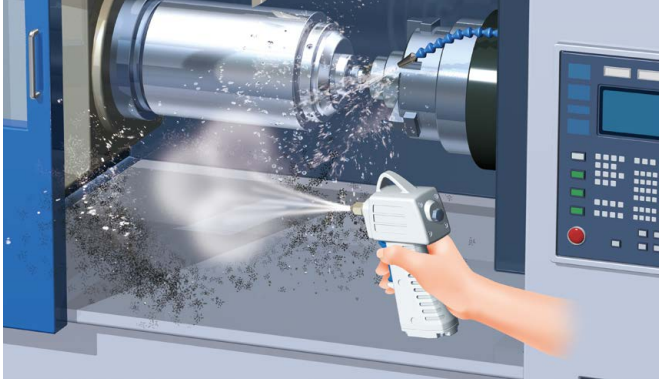

For the removal of foreign matter with a single shot from a distance



For the separation of workpieces stuck together with oil, etc.

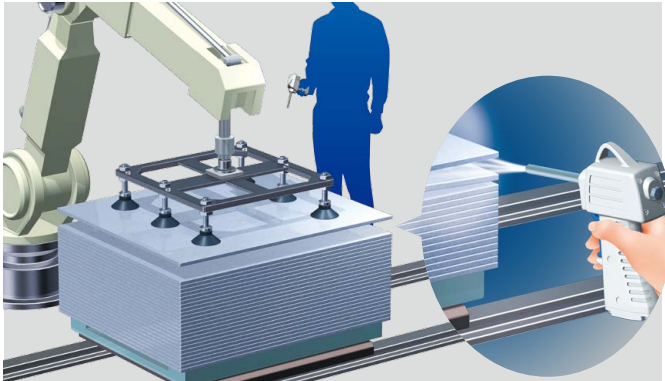

For finishing the removal of water droplets

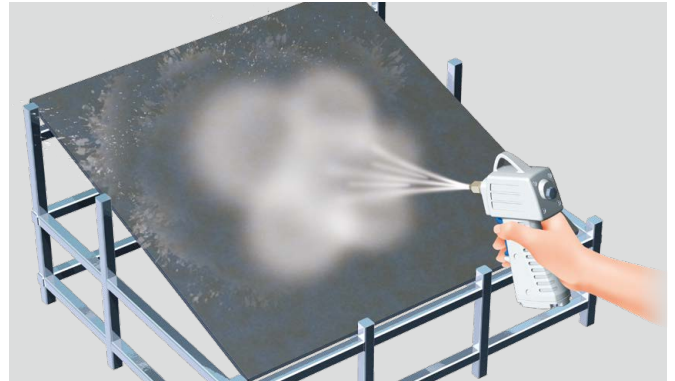

For blowing away sticky soil



For the removal of dust



CONTENTS

	High Peak Pressure Type Impact Blow Gun
	IBG1 Series
	How to Order p. 4
	Specifications p. 4

	Compact Type Impact Blow Gun
	IBG2 Series
	How to Order p. 5
	Specifications p. 5

Dimensions	p. 6
How to Mount a Nozzle	p. 8
Specific Product Precautions	p. 9

High Peak Pressure Type Impact Blow Gun **IBG1 Series**

RoHS

How to Order

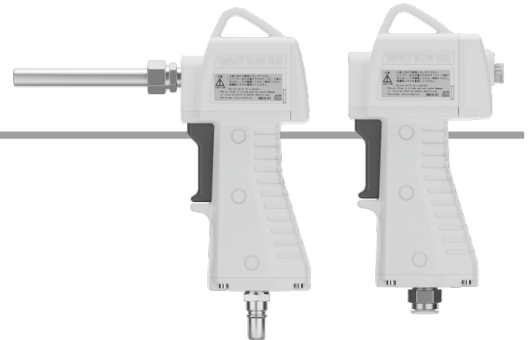

Symbol

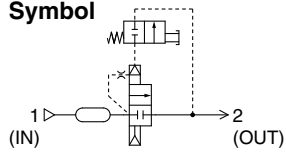

Without adjuster

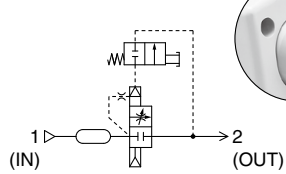

With adjuster

IBG1 0 - 02

Adjuster

Symbol	Type
0	Without adjuster
1	With adjuster

Supply port Screw-in type

Symbol	Size
Nil	Rc3/8
N	NPT3/8
F	G3/8

Nozzle (Refer to page 8 for details.)

Symbol	Type	Nozzle length	Nozzle part no.*2
Nil	Without nozzle	—	—
01	Long nozzle*1	50 mm	IBG1-12-10-50
02		100 mm	IBG1-12-10-100
03		150 mm	IBG1-12-10-150
04		300 mm	IBG1-12-10-300
05		600 mm	IBG1-12-10-600-X1
06		1000 mm	IBG1-12-10-1000-X1
11	Long nozzle with a silencer*1, *3	50 mm	IBG1-12-10-50S
12		100 mm	IBG1-12-10-100S
13		150 mm	IBG1-12-10-150S
14		300 mm	IBG1-12-10-300S
15		600 mm	IBG1-12-10-600S-X1
16		1000 mm	IBG1-12-10-1000S-X1

*1 A long nozzle and a silencer are included in a package but do not come mounted. Refer to page 8 for assembly procedures.

*2 This is the part number for the long nozzle and fitting set.

*3 The silencer and long nozzle can be used together. Part number for ordering a silencer alone is **IBG1-12S**.

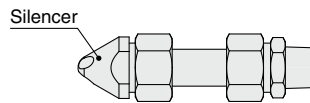

With S coupler/One-touch fitting

	Symbol	Applicable tubing O.D.	Part no.	Appearance
S coupler	11	—	KK4P-03MS	
	12	—	KK130P-03MS	
One-touch fitting	H06	ø6	KQ2H06-03AS	
	H08	ø8	KQ2H08-03AS	
	H10	ø10	KQ2H10-03AS	
	H07	ø1/4"	KQ2H07-36AS	
	H09	ø5/16"	KQ2H09-36AS	
	H11	ø3/8"	KQ2H11-36AS	

* The S coupler or fitting is shipped together with the product.

* For the S coupler or metric size One-touch fitting (H06, H08, H10), the port size on the impact blow gun side is Rc3/8.

* For the inch size One-touch fitting (H07, H09, H11), the port size on the impact blow gun side is NPT3/8.

Specifications

Model	IBG10 (Without adjuster)	IBG11 (With adjuster)
Fluid	Air	
Max. operating pressure	0.7 MPa	
Proof pressure	1.05 MPa	
Fluid and ambient temperature range	+5 to +60°C	
Operational force	10 N or less	
Weight*1	380 g	400 g

*1 For the screw-in type

Chip Guard (Please order it separately.) p. 8

Guards against the blown machining chips and workpiece

Description	Part no.
Chip guard	IBG1-12C



Compact Type Impact Blow Gun **IBG2 Series**



How to Order

Symbol

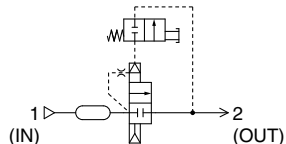

Without adjuster

IBG20 - **02**

Supply port
Screw-in type

Symbol	Size
Nil	Rc1/4
N	NPT1/4
F	G1/4

• Nozzle (Refer to page 8 for details.)

Symbol	Type	Nozzle length	Nozzle part no.*2
Nil	Without nozzle	—	—
01	Long nozzle*1	50 mm	IBG1-12-10-50
02		100 mm	IBG1-12-10-100
03		150 mm	IBG1-12-10-150
04		300 mm	IBG1-12-10-300
05		600 mm	IBG1-12-10-600-X1
06		1000 mm	IBG1-12-10-1000-X1
11	Long nozzle with a silencer*1, *3	50 mm	IBG1-12-10-50S
12		100 mm	IBG1-12-10-100S
13		150 mm	IBG1-12-10-150S
14		300 mm	IBG1-12-10-300S
15		600 mm	IBG1-12-10-600S-X1
16		1000 mm	IBG1-12-10-1000S-X1

With S coupler/One-touch fitting

	Symbol	Applicable tubing O.D.	Part no.	Appearance
S coupler	11	—	KK4P-02MS	
	12	—	KK130P-02MS	
One-touch fitting	H06	ø6	KQ2H06-02AS	
	H08	ø8	KQ2H08-02AS	
	H10	ø10	KQ2H10-02AS	
	H07	ø1/4"	KQ2H07-35AS	
	H09	ø5/16"	KQ2H09-35AS	
	H11	ø3/8"	KQ2H11-35AS	

- * The S coupler or fitting is shipped together with the product.
- * For the S coupler or metric size One-touch fitting (H06, H08, H10), the port size on the impact blow gun side is Rc1/4.
- * For the inch size One-touch fitting (H07, H09, H11), the port size on the impact blow gun side is NPT1/4.

- *1 A long nozzle and a silencer are included in a package but do not come mounted. Refer to page 8 for assembly procedures.
- *2 This is the part number for the long nozzle and fitting set.
- *3 The silencer and long nozzle can be used together. Part number for ordering a silencer alone is **IBG1-12S**.

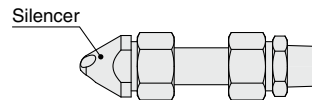

Specifications

Model	IBG20 (Without adjuster)
Fluid	Air
Max. operating pressure	0.7 MPa
Proof pressure	1.05 MPa
Fluid and ambient temperature range	+5 to +60°C
Operational force	10 N or less
Weight*1	300 g

*1 For the screw-in type

Chip Guard (Please order it separately.) **p. 8**

Guards against the blown machining chips and workpiece

Description	Part no.
Chip guard	IBG1-12C



Dimensions

IBG10/Without adjuster

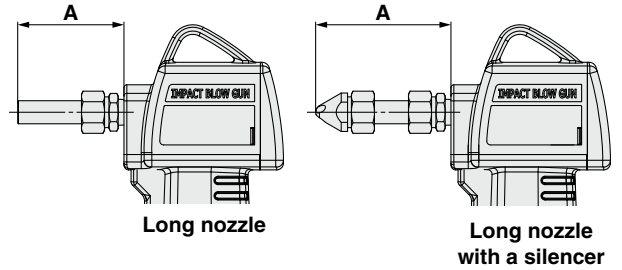
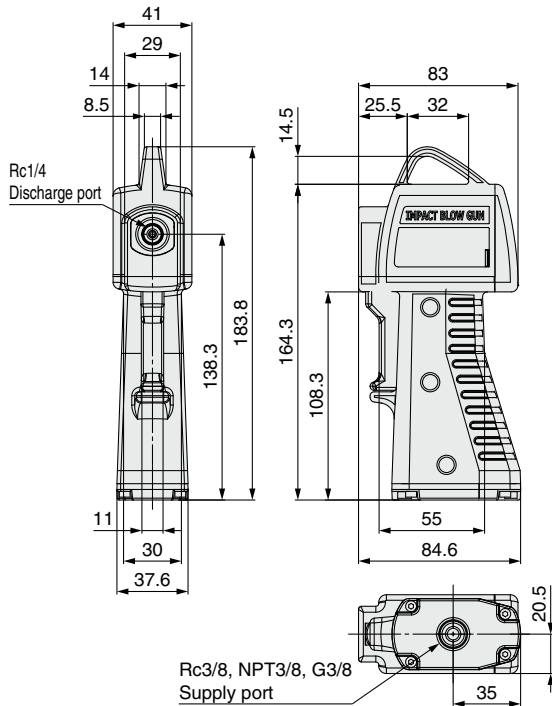

Symbol	Type	Nozzle length [mm]	Nozzle part no.	A [mm]	Weight [g]
01	Long nozzle	50	IBG1-12-10-50	57	35
02		100	IBG1-12-10-100	107	40
03		150	IBG1-12-10-150	157	45
04		300	IBG1-12-10-300	307	59
05		600	IBG1-12-10-600-X1	607	88
06		1000	IBG1-12-10-1000-X1	1007	126
11	Long nozzle with a silencer	50	IBG1-12-10-50S	72	57
12		100	IBG1-12-10-100S	122	62
13		150	IBG1-12-10-150S	172	67
14		300	IBG1-12-10-300S	322	81
15		600	IBG1-12-10-600S-X1	622	110
16		1000	IBG1-12-10-1000S-X1	1022	148

IBG11/With adjuster

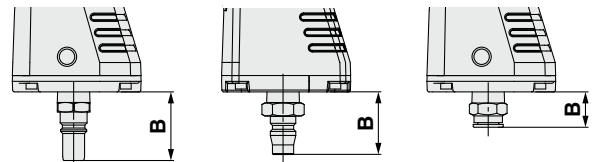
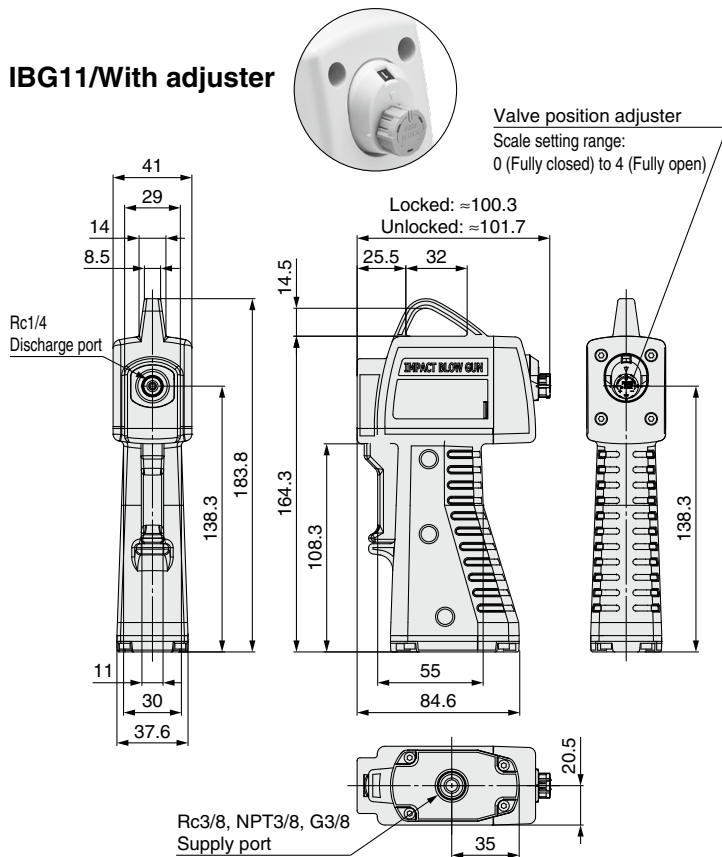

Symbol	Type	Applicable tubing O.D.	Part no.	B [mm]
11	S coupler	—	KK4P-03MS	35.7
12		—	KK130P-03MS	32.5
H06	Metric size	ø6	KQ2H06-03AS	13
H08	One-touch fitting	ø8	KQ2H08-03AS	13
H10		ø10	KQ2H10-03AS	18.4
H07	Inch size	ø1/4"	KQ2H07-36AS	13.4
H09	One-touch fitting	ø5/16"	KQ2H09-36AS	13.4
H11		ø3/8"	KQ2H11-36AS	18

IBG Series

Dimensions

IBG20/Without adjuster

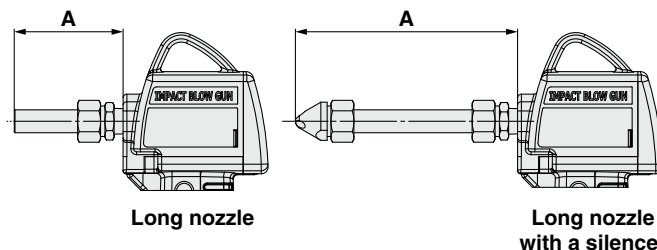
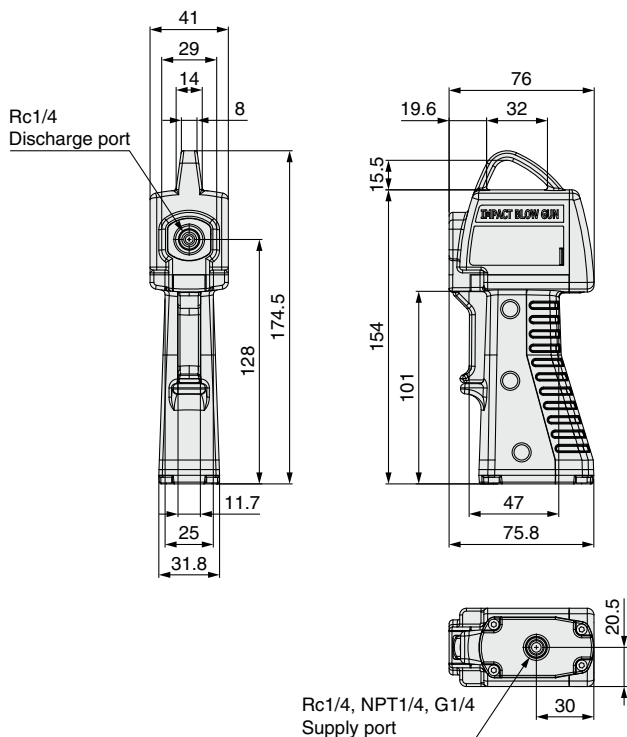

Symbol	Type	Nozzle length [mm]	Nozzle part no.	A [mm]	Weight [g]
01	Long nozzle	50	IBG1-12-10-50	57	35
02		100	IBG1-12-10-100	107	40
03		150	IBG1-12-10-150	157	45
04		300	IBG1-12-10-300	307	59
05		600	IBG1-12-10-600-X1	607	88
06		1000	IBG1-12-10-1000-X1	1007	126
11	Long nozzle with a silencer	50	IBG1-12-10-50S	72	57
12		100	IBG1-12-10-100S	122	62
13		150	IBG1-12-10-150S	172	67
14		300	IBG1-12-10-300S	322	81
15		600	IBG1-12-10-600S-X1	622	110
16		1000	IBG1-12-10-1000S-X1	1022	148

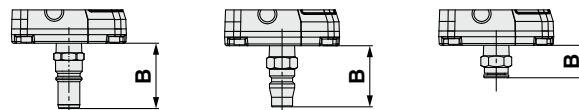

With S coupler plug mounted KK4P-02MS With S coupler plug mounted KK130P-02MS With One-touch fitting mounted KQ2H□-□AS

Symbol	Type	Applicable tubing O.D.	Part no.	B [mm]
11	S coupler	—	KK4P-02MS	34.2
12		—	KK130P-02MS	32
H06	Metric size	ø6	KQ2H06-02AS	12
H08	One-touch fitting	ø8	KQ2H08-02AS	17.3
H10		ø10	KQ2H10-02AS	22.6
H07	Inch size One-touch fitting	ø1/4"	KQ2H07-35AS	12.3
H09		ø5/16"	KQ2H09-35AS	17.7
H11		ø3/8"	KQ2H11-35AS	20.7

Dimensions

Long nozzle (Option)

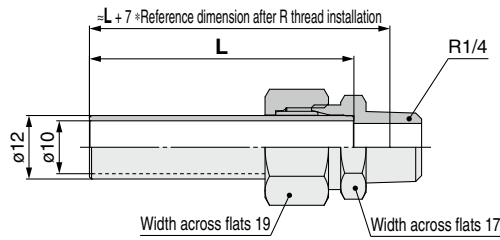
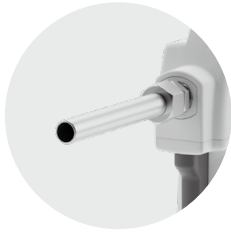

Part no.	Nozzle I.D.	Connection thread	L [mm]
IBG1-12-10-50	ø10	R1/4	50
IBG1-12-10-100			100
IBG1-12-10-150			150
IBG1-12-10-300			300
IBG1-12-10-600-X1			600
IBG1-12-10-1000-X1			1000

Long nozzle with a silencer (Option)

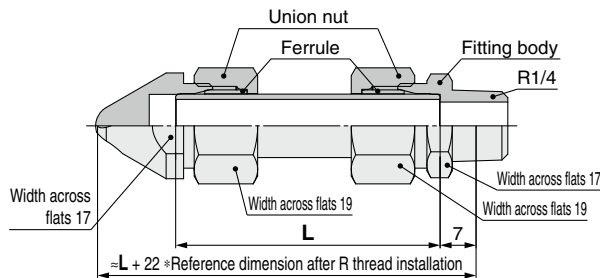

Part no.	L [mm]
IBG1-12-10-50S	50
IBG1-12-10-100S	100
IBG1-12-10-150S	150
IBG1-12-10-300S	300
IBG1-12-10-600S-X1	600
IBG1-12-10-1000S-X1	1000

Chip guard (Please order it separately.)

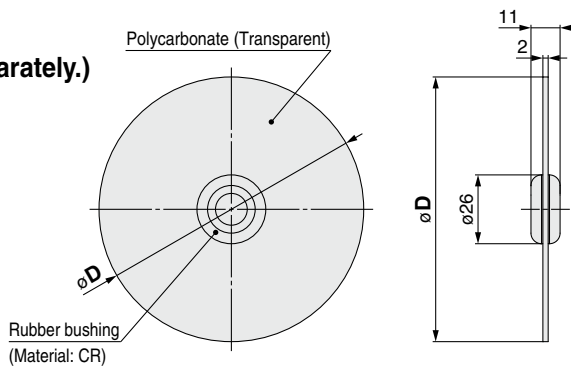

Part no.	øD [mm]
IBG1-12C	100

- * The rubber bushing is shipped together with the product.
- * It is possible to use the guard with a silencer, but in that case, mount the guard before mounting the silencer.

How to Mount a Nozzle

Preparation

- 1 Check that the ferrule is mounted inside the fitting as shown in the figure below. Hand-tighten the union nut. Ensure the ferrule is aligned properly.

Tighten the union nut until it touches the body.

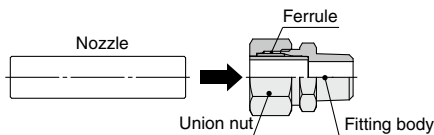

- 2 Insert the nozzle until it touches the fitting body. Then, mark a line on the nozzle at the edge of the union nut.

Insert the nozzle until it touches the bottom of the fitting body.

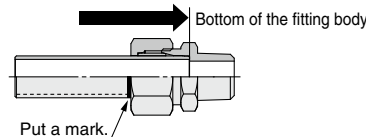

- 3 Remove the nozzle once, and check the dimension from the end of the nozzle to the marking. If the dimension is different from the 17 mm, verify the alignment of the nozzle and adjust.

Remove it once, and check the dimension.

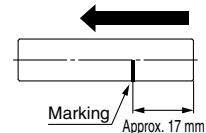

Tightening

- 4 After verifying the dimension, insert the nozzle into the fitting body again. Confirm that the nozzle is inserted down to the marking.

Insert to the marking.

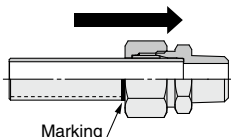

- 5 Using the tightening tool, tighten the union nut so that the gap between the fitting body and the union nut becomes 2 mm or less.

Tighten the union nut so that the clearance is 2 mm or less.

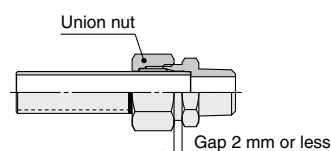

- 6 Pull the nozzle by hand to ensure that the nozzle is secure. Before operation, pull the nozzle by hand again to confirm that the nozzle is securely attached and will not be ejected during operation.



IBG Series

Specific Product Precautions 1

Be sure to read this before handling the products. Refer to the back cover for safety instructions. For other precautions, refer to the “Handling Precautions for SMC Products” and the “Operation Manual” on the SMC website: <https://www.smcworld.com>

Prior to Use

Warning

As the pressure of the air blow is quite powerful, do not aim the product at another person during operation. It may cause danger to personnel. Additionally, the following precautions should be taken before use.

1. Before use, make sure that the blow pressure, or blow, will not cause surrounding objects to scatter and injure others or damage workpieces, equipment, etc., in the vicinity.
2. Wear protective eyewear when operating the product to protect your eyes from scattering debris.
3. This product is not a toy. Do not play with the product or use it as an air gun for fun.
4. Air pressure may cause the nozzle to fly off during operation if it is not properly tightened. To prevent this, be sure to check the nozzle for loosening by pulling on it with your hands before use.
5. The grip may become hot due to repeated operation; however, this is not abnormal.

Selection

Warning

1. Confirm the specifications.

Products represented in this catalog are designed only for use in compressed air systems. Do not operate at pressures, temperatures, etc., beyond the range of specifications, as this can cause damage or malfunction.

Caution

1. Do not apply the blow gun to flammable, explosive, or toxic substances such as gas, fuel gas, or refrigerant. Such substances may exude from inside the blow gun.

Mounting

Warning

1. Install a stop valve on the supply pressure side of the blow gun.

It will be emergency shut off in case of unexpected leakage or damage.

2. When installing a nozzle on the blow gun, wind sealant tape around the threads of the nozzle.

Mounting

Warning

3. Screw-in the nozzle to the torque below by holding the flat faces on the discharge side or metal holder. As a guideline, it is equivalent to 2 to 3 additional turns with a tool after hand-tightening.

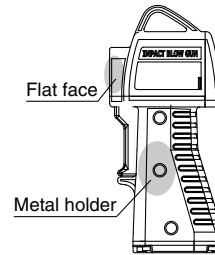

Nozzle tightening torque range 12 to 14 N·m

Insufficient tightening may cause loosening of the nozzle.

Piping

Caution

1. Check the model, type, and size before installation. Also, confirm that there are no scratches, gouges, or cracks on the product.

2. Preparation before piping

Before piping is connected, it should be thoroughly blown out with air (flushing) or washed to remove chips, cutting oil, and other debris from inside the pipe.

3. Winding of sealant tape

When connecting pipes, fittings, etc., be sure that chips from the pipe threads and sealing material do not enter the blow gun. Furthermore, when sealant tape is used, leave 1.5 to 2 thread ridges exposed at the end of the threads.

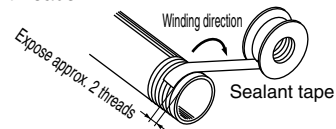

4. When tightening the threads, tighten with torque specified in the table below. As a guideline, it is equivalent to 2 to 3 additional turns with a tool after hand-tightening.

Be careful that tightening with torque beyond the range in the table below may cause damage to the body.

Male thread	Tightening torque [N·m]
R1/4	12 to 14
R3/8	22 to 24

5. Allow extra length when connecting a tube to accommodate changes in tube length due to pressure.
6. Confirm that no twisting, turning, or tensile force or moment load is applied to the port or tube. This may cause fittings to fracture or tubes to be crushed, burst, or come loose.
7. Do not abrade, entangle, or scratch the tube. This may cause the tube to be crushed, burst, or come loose.



Specific Product Precautions 2

Be sure to read this before handling the products. Refer to the back cover for safety instructions. For other precautions, refer to the “Handling Precautions for SMC Products” and the “Operation Manual” on the SMC website: <https://www.smcworld.com>

Lubrication

⚠ Warning

1. **Do not lubricate the product.**
It may contaminate or damage the target object.

Air Supply

⚠ Warning

1. **Use clean air.**
Do not use compressed air that contains chemicals, synthetic oils that include organic solvents, salt, corrosive gases, etc., as it can cause damage or malfunction.

⚠ Caution

1. **Install an air filter.**
Install an air filter upstream near the blow gun. Select an air filter with a filtration size of 5 μm or smaller.
2. **Take measures to ensure air quality, such as by installing an aftercooler, air dryer, or water separator.**
Compressed air that contains a large amount of drainage can cause the malfunction of the blow gun and contaminate or damage the target object. Therefore, take appropriate measures to ensure air quality, such as by providing an aftercooler, air dryer, or water separator.

Operating Environment

⚠ Warning

1. **Do not use in an atmosphere where corrosive gases, chemicals, sea water, water, or water steam are present. Do not use in cases where there is direct contact with any of the above.**
2. **Do not expose the product to direct sunlight for an extended period of time.**
3. **Do not use in locations where radiated heat will be received from nearby heat sources.**
4. **Do not use in an environment where static electricity is a problem. It may result in system failure or malfunction. Please contact SMC for use in such an environment.**
5. **Do not use in an environment where spatters are generated. Spattering may result in a fire hazard. Please contact SMC for use in such an environment.**
6. **Do not use in an environment where the product is exposed to cutting oil, lubricating oil, or coolant oil. Please contact SMC for use in such an environment.**

Maintenance

⚠ Caution

1. **In periodical inspections, check the following items and replace the parts if necessary.**
 - a) Scratches, gouges, abrasion, corrosion
 - b) Air leakage
 - c) Twisting, crushing, and turning of connected tubes
 - d) Hardening, deterioration, and softening of connected tubes
 - e) Loosening of nozzles
2. **When removing the product, first stop the pressure supply, exhaust compressed air in the piping, and check the condition of atmospheric release.**
3. **Do not disassemble or remodel the body of the product.**

Handling

⚠ Warning

1. **Air pressure may cause the nozzle to fly off during operation if it is not properly tightened. To prevent this, be sure to check the nozzle for loosening by pulling on it with your hands before use.**
2. **Be sure to wear protective eyewear when operating the product to protect your eyes from scattering debris.**
3. **Do not direct the tip of the nozzle at the face or other parts of a human body. It may cause danger to personnel.**
4. **Do not use the product to clean or remove toxic substances or chemicals.**
5. **Do not drop, step on, or hit the product. It may cause damage to the product.**
6. **Do not use the product to disturb public order or public hygiene.**
7. **This product is not a toy.**
8. **After blowing, make sure to hang the product on a hook, etc.**
If leaving the product in a dusty place, particles will enter the product and may result in a malfunction.

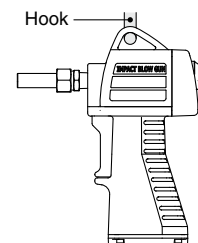

9. **When the blow gun is used or stored, confirm that no twisting, turning, or tensile force or moment load is applied to the port or tube. This may cause fittings to fracture or tubes to be crushed, burst, or come loose.**

⚠ Caution

1. **Pressurizing the air blow discharge port may result in the breakage of the product.**
2. **The blow adjusting range 4 provides the maximum blow. Rotating the adjuster exceeding 4 may result in the breakage of the product.**

Safety Instructions

These safety instructions are intended to prevent hazardous situations and/or equipment damage. These instructions indicate the level of potential hazard with the labels of “**Caution**,” “**Warning**” or “**Danger**.” They are all important notes for safety and must be followed in addition to International Standards (ISO/IEC)*1), and other safety regulations.

 **Caution:** **Caution** indicates a hazard with a low level of risk which, if not avoided, could result in minor or moderate injury.

 **Warning:** **Warning** indicates a hazard with a medium level of risk which, if not avoided, could result in death or serious injury.

 **Danger :** **Danger** indicates a hazard with a high level of risk which, if not avoided, will result in death or serious injury.

*1) ISO 4414: Pneumatic fluid power – General rules relating to systems.
ISO 4413: Hydraulic fluid power – General rules relating to systems.
IEC 60204-1: Safety of machinery – Electrical equipment of machines.
(Part 1: General requirements)
ISO 10218-1: Manipulating industrial robots – Safety.
etc.

Warning

1. The compatibility of the product is the responsibility of the person who designs the equipment or decides its specifications.

Since the product specified here is used under various operating conditions, its compatibility with specific equipment must be decided by the person who designs the equipment or decides its specifications based on necessary analysis and test results. The expected performance and safety assurance of the equipment will be the responsibility of the person who has determined its compatibility with the product. This person should also continuously review all specifications of the product referring to its latest catalog information, with a view to giving due consideration to any possibility of equipment failure when configuring the equipment.

2. Only personnel with appropriate training should operate machinery and equipment.

The product specified here may become unsafe if handled incorrectly. The assembly, operation and maintenance of machines or equipment including our products must be performed by an operator who is appropriately trained and experienced.

3. Do not service or attempt to remove product and machinery/equipment until safety is confirmed.

1. The inspection and maintenance of machinery/equipment should only be performed after measures to prevent falling or runaway of the driven objects have been confirmed.
2. When the product is to be removed, confirm that the safety measures as mentioned above are implemented and the power from any appropriate source is cut, and read and understand the specific product precautions of all relevant products carefully.
3. Before machinery/equipment is restarted, take measures to prevent unexpected operation and malfunction.

4. Contact SMC beforehand and take special consideration of safety measures if the product is to be used in any of the following conditions.

1. Conditions and environments outside of the given specifications, or use outdoors or in a place exposed to direct sunlight.
2. Installation on equipment in conjunction with atomic energy, railways, air navigation, space, shipping, vehicles, military, medical treatment, combustion and recreation, or equipment in contact with food and beverages, emergency stop circuits, clutch and brake circuits in press applications, safety equipment or other applications unsuitable for the standard specifications described in the product catalog.
3. An application which could have negative effects on people, property, or animals requiring special safety analysis.
4. Use in an interlock circuit, which requires the provision of double interlock for possible failure by using a mechanical protective function, and periodical checks to confirm proper operation.

Caution

1. The product is provided for use in manufacturing industries.

The product herein described is basically provided for peaceful use in manufacturing industries.
If considering using the product in other industries, consult SMC beforehand and exchange specifications or a contract if necessary.
If anything is unclear, contact your nearest sales branch.

Limited warranty and Disclaimer/ Compliance Requirements

The product used is subject to the following “Limited warranty and Disclaimer” and “Compliance Requirements”.

Read and accept them before using the product.

Limited warranty and Disclaimer

1. The warranty period of the product is 1 year in service or 1.5 years after the product is delivered, whichever is first.*2)
Also, the product may have specified durability, running distance or replacement parts. Please consult your nearest sales branch.
2. For any failure or damage reported within the warranty period which is clearly our responsibility, a replacement product or necessary parts will be provided.
This limited warranty applies only to our product independently, and not to any other damage incurred due to the failure of the product.
3. Prior to using SMC products, please read and understand the warranty terms and disclaimers noted in the specified catalog for the particular products.

*2) Vacuum pads are excluded from this 1 year warranty.

A vacuum pad is a consumable part, so it is warranted for a year after it is delivered.
Also, even within the warranty period, the wear of a product due to the use of the vacuum pad or failure due to the deterioration of rubber material are not covered by the limited warranty.

Compliance Requirements

1. The use of SMC products with production equipment for the manufacture of weapons of mass destruction (WMD) or any other weapon is strictly prohibited.
2. The exports of SMC products or technology from one country to another are governed by the relevant security laws and regulations of the countries involved in the transaction. Prior to the shipment of a SMC product to another country, assure that all local rules governing that export are known and followed.

Caution

SMC products are not intended for use as instruments for legal metrology.

Measurement instruments that SMC manufactures or sells have not been qualified by type approval tests relevant to the metrology (measurement) laws of each country. Therefore, SMC products cannot be used for business or certification ordained by the metrology (measurement) laws of each country.

Revision History

- Edition B** * The IBG2 series has been added.
* The number of pages has been increased from 8 to 12.

BP

 **Safety Instructions** Be sure to read the “Handling Precautions for SMC Products” (M-E03-3) and “Operation Manual” before use.

SMC Corporation

Akihabara UDX 15F,
4-14-1, Sotokanda, Chiyoda-ku, Tokyo 101-0021, JAPAN
Phone: 03-5207-8249 Fax: 03-5298-5362
<https://www.smcworld.com>
© 2023 SMC Corporation All Rights Reserved

Specifications are subject to change without prior notice
and any obligation on the part of the manufacturer.

D-G