

Compact Guide Cylinder

ø12, ø16, ø20, ø25, ø32, ø40, ø50

RoHS

New • Bore sizes ø12, ø20, ø25, ø40, and ø50 have been added.

Volume

Max. **28%** reduction

538 cm³ → **390 cm³**

Compared with the MGPM, ø32, 25 mm stroke

Weight

Max. **41%** reduction

0.32 kg → **0.19 kg**

Compared with the existing model (MGPM), ø16, 10 mm stroke

High rigidity

Optimized configuration allows for compact body with high rigidity

The lateral load, allowable kinetic energy, and non-rotating accuracy are equivalent to those of the existing model (MGP-Z).

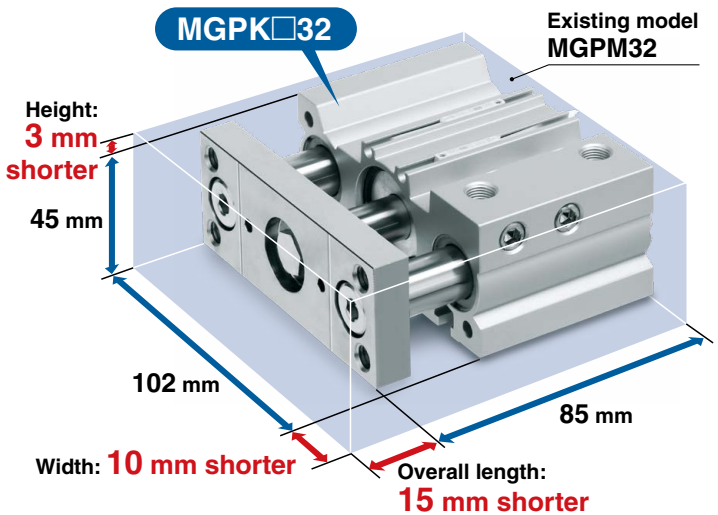

MGPK Series



CAT.ES20-270B

Plate thickness increased by up to **33%**
Higher rigidity

ø50 12 mm → **16 mm**

The plate material is selectable.

- Carbon steel
- Aluminum alloy (Allows for reduced weight)

A Lube-retainer has been added to the guide rod.

- Lubrication is maintained by the Lube-retainer.
- Prevents the entry of foreign matter

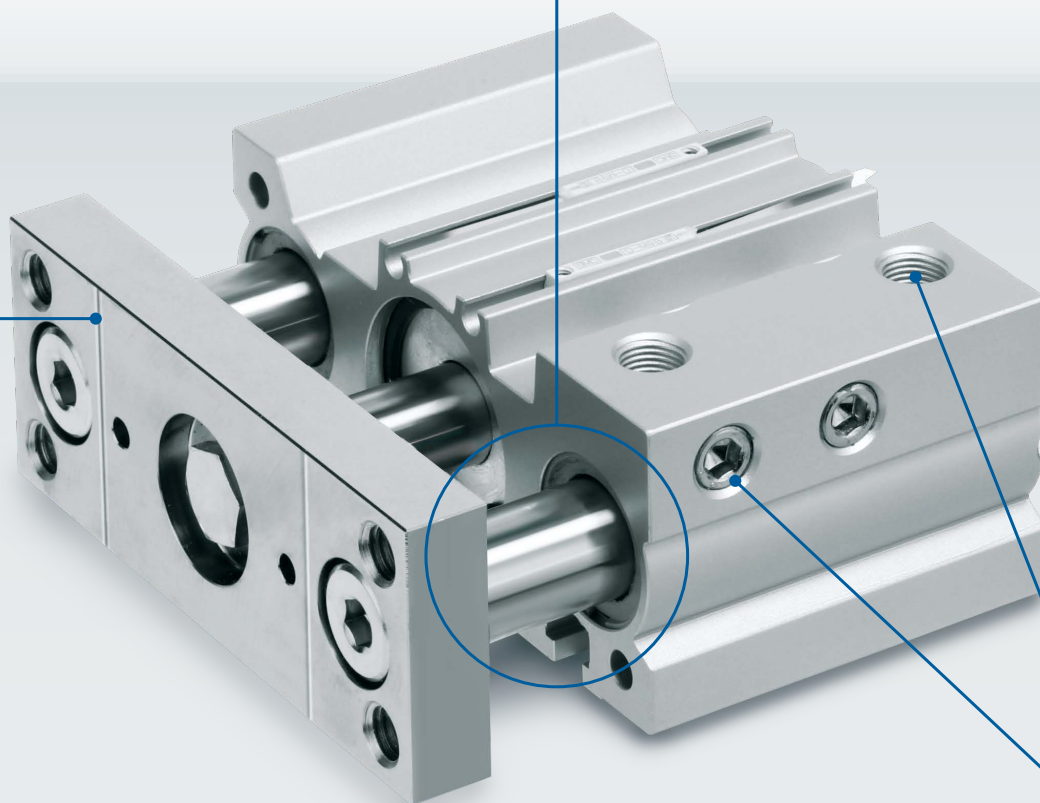
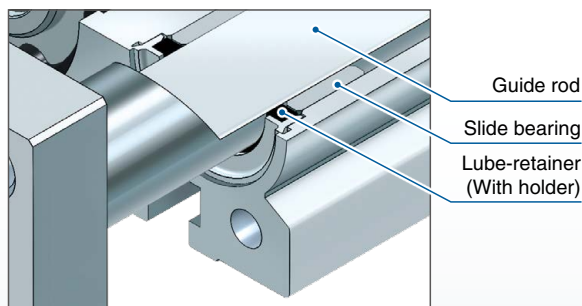

2 types of piping port locations can be selected. (p. 18)

ø12 to ø50

① Top ported

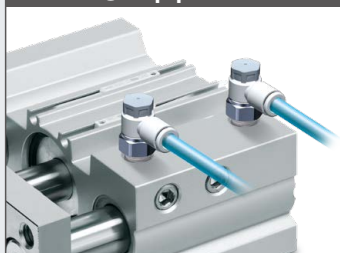

② Side ported



ø12, ø16 (Without port plugs on the side)

Top ported

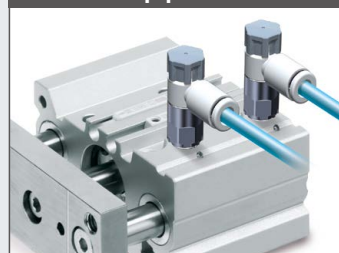

Since the only ports are on the top surface, no plugs are required on the side, meaning **the width of the body can be reduced.**

4 types of mounting are possible.

- Easy positioning
- Knock pin holes provided on each mounting surface

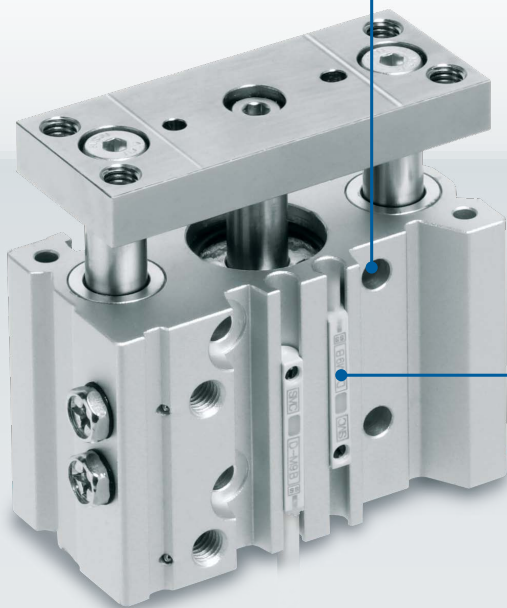
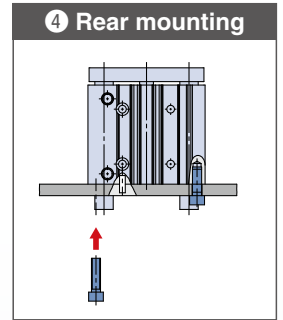
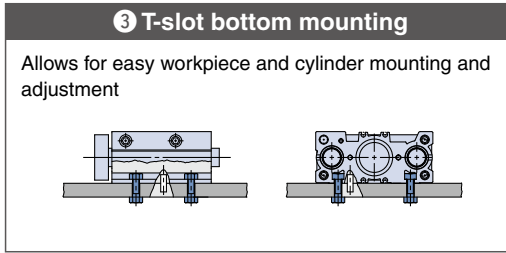
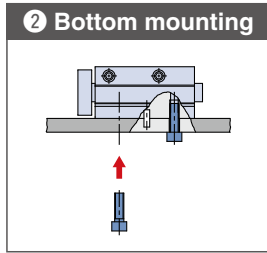
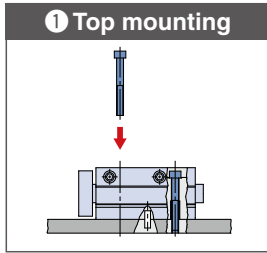

Small auto switches can be directly mounted on **2 surfaces.** **D-M9** **D-A9**

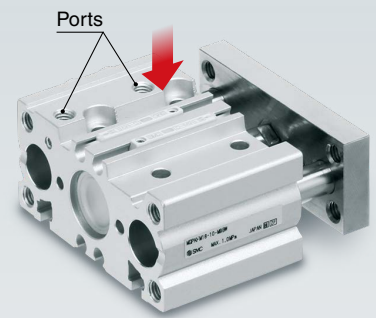

Application Examples

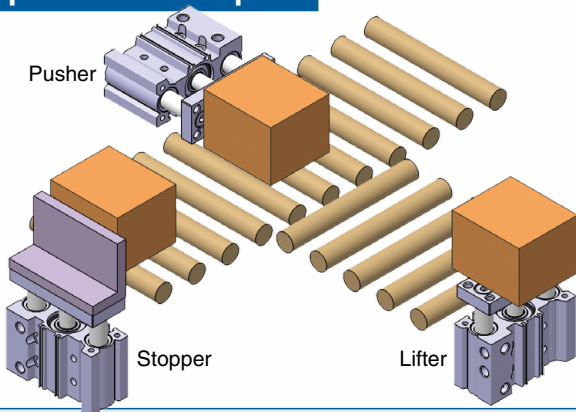

CONTENTS

How to Order	p. 3
Specifications	p. 4
Weight	p. 5
Construction	p. 6
Dimensions	p. 7
Model Selection	p. 9
Auto Switch Mounting	p. 15
Prior to Use	p. 16
Specific Product Precautions	p. 17

Compact Guide Cylinder Variations

Series	Bearing	Bore size [mm]							Cushion	Piping	Standard stroke [mm]
		12	16	20	25	32	40	50			
Basic type MGPK	Slide bearing	●	●	●	●	●	●	●	Rubber	· Top/Side ported · Top ported (ø12 and ø16 only)	ø12, ø16: 10 to 150 ø20, ø25: 20 to 200 ø32 to ø50: 25 to 200

Compact Guide Cylinder

MGPK Series

ø12, ø16, ø20, ø25, ø32, ø40, ø50

RoHS

How to Order

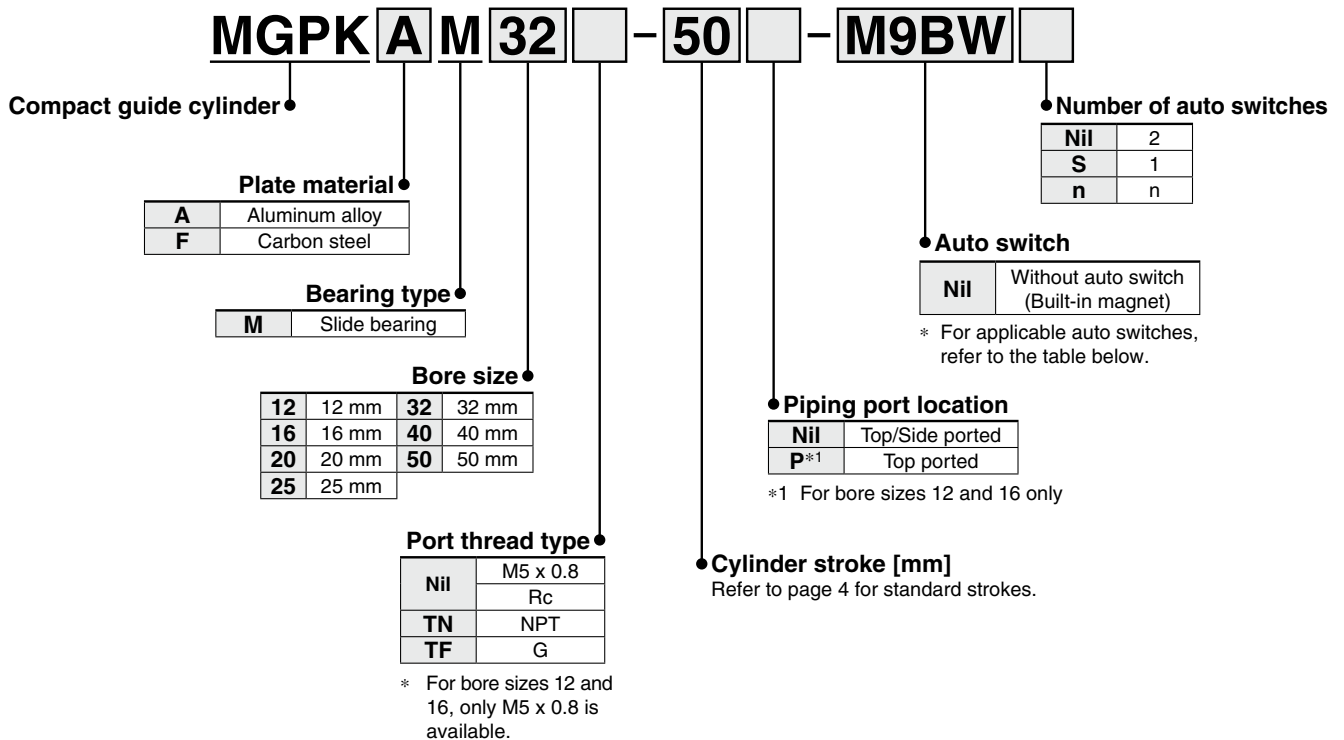

Applicable Auto Switches / Refer to the Web Catalog for further information on auto switches.

Type	Special function	Electrical entry	Indicator light	Wiring (Output)	Load voltage		Auto switch model		Lead wire length [m]				Pre-wired connector	Applicable load					
					DC	AC	Perpendicular	In-line	0.5 (Nil)	1 (M)	3 (L)	5 (Z)							
Solid state auto switch	—	Grommet	Yes	3-wire (NPN)	24 V	5 V, 12 V	—	M9NV	M9N	●	●	●	○	○	IC circuit	Relay, PLC			
				3-wire (PNP)				M9PV	M9P	●	●	●	○	○					
				2-wire				M9BV	M9B	●	●	●	○	○					
	Diagnostic indication (2-color indicator)			3-wire (NPN)	24 V	5 V, 12 V	—	M9NWV	M9NW	●	●	●	○	○	○		IC circuit		
				3-wire (PNP)				M9PWV	M9PW	●	●	●	○	○					
				2-wire				M9BWV	M9BW	●	●	●	○	○					
	Water resistant (2-color indicator)			3-wire (NPN)	24 V	5 V, 12 V	—	M9NAV*1	M9NA*1	○	○	●	○	○	○		IC circuit		
				3-wire (PNP)				M9PAV*1	M9PA*1	○	○	●	○	○					
				2-wire				M9BAV*1	M9BA*1	○	○	●	○	○					
Reed auto switch	—	Grommet	Yes	3-wire (NPN equivalent)	24 V	5 V	—	A96V	A96	●	—	●	—	—	IC circuit	—			
				2-wire				100 V	A93V*2	A93	●	●	●	●			—	—	Relay, PLC
								100 V or less	A90V	A90	●	—	●	—			—		

*1 Water-resistant type auto switches can be mounted on the above models, but SMC cannot guarantee water resistance.

*2 The 1 m lead wire is only applicable to the D-A93.

* Lead wire length symbols: 0.5 m..... Nil (Example) M9NW
 1 m..... M (Example) M9NWM
 3 m..... L (Example) M9NWL
 5 m..... Z (Example) M9NWZ

* Solid state auto switches marked with a "○" are produced upon receipt of order.

* For details on auto switches with pre-wired connectors, refer to the Web Catalog.

* Auto switches are shipped together with the product but do not come assembled.

* Reed auto switches are only available for bore sizes ø16 to ø50.



Symbol

Rubber bumper

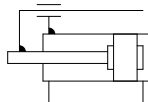

Refer to page 15 for cylinders with auto switches.

- Auto Switch Proper Mounting Position (Detection at stroke end) and Mounting Height
- Min. Stroke for Auto Switch Mounting
- Operating Range
- Auto Switch Mounting

Specifications

Bore size [mm]	ø12	ø16	ø20	ø25	ø32	ø40	ø50
Action	Double acting						
Fluid	Air						
Proof pressure	1.5 MPa						
Max. operating pressure	1.0 MPa						
Min. operating pressure	0.12 MPa	0.1 MPa					
Ambient and fluid temperatures	-10 to 60°C (No freezing)						
Piston speed*1	50 to 500 mm/s						
Cushion	Rubber bumper on both ends						
Lubrication	Not required (Non-lube)						
Stroke length tolerance	0 to $^{+1.5}_0$ mm						

*1 Speed with no load. Depending on the operating conditions, the piston speed may not be satisfied.

Standard Strokes

Bore size [mm]	Standard stroke [mm]
12, 16	10, 20, 30, 40, 50, 75, 100, 125, 150
20, 25	20, 30, 40, 50, 75, 100, 125, 150, 175, 200
32 to 50	25, 50, 75, 100, 125, 150, 175, 200

Manufacturing of Intermediate Strokes

Description	Spacer installation type Spacers are installed in the standard stroke cylinder. · ø12 to ø32: Stroke can be modified in 1 mm increments. · ø40, ø50: Stroke can be modified in 5 mm increments.	
Part no.	Refer to the "How to Order" for the standard model numbers.	
Applicable stroke [mm]	ø12, ø16	1 to 149
	ø20, ø25, ø32	1 to 199
	ø40, ø50	5 to 195
Example	Part no.: MGPKAM16-39 A 1 mm spacer is installed in MGPKAM16-40. Dimension C is 68.5 mm.	

Theoretical Output

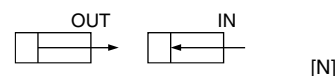

Bore size [mm]	Rod size [mm]	Operating direction	Piston area [mm ²]	Operating pressure [MPa]										
				0.2	0.3	0.4	0.5	0.6	0.7	0.8	0.9	1.0		
12	6	OUT	113	23	34	45	57	68	79	90	102	113		
		IN	85	17	25	34	42	51	59	68	76	85		
16	8	OUT	201	40	60	80	101	121	141	161	181	201		
		IN	151	30	45	60	75	90	106	121	136	151		
20	10	OUT	314	63	94	126	157	188	220	251	283	314		
		IN	236	47	71	94	118	141	165	188	212	236		
25	10	OUT	491	98	147	196	245	295	344	393	442	491		
		IN	412	82	124	165	206	247	289	330	371	412		
32	14	OUT	804	161	241	322	402	483	563	643	724	804		
		IN	650	130	195	260	325	390	455	520	585	650		
40	16	OUT	1257	251	377	503	628	754	880	1005	1131	1257		
		IN	1056	211	317	422	528	634	739	845	950	1056		
50	20	OUT	1963	393	589	785	982	1178	1374	1571	1767	1963		
		IN	1649	330	495	660	825	990	1154	1319	1484	1649		

* Theoretical output [N] = Pressure [MPa] x Piston area [mm²]

MGPK Series

Weight

Bore size [mm]	Plate material	Standard stroke [mm]											
		10	20	25	30	40	50	75	100	125	150	175	200
12	Carbon steel	0.18	0.22	—	0.25	0.28	0.32	0.42	0.50	0.60	0.69	—	—
	Aluminum alloy	0.15	0.18	—	0.22	0.25	0.28	0.38	0.47	0.57	0.65	—	—
16	Carbon steel	0.23	0.27	—	0.31	0.35	0.39	0.51	0.61	0.74	0.83	—	—
	Aluminum alloy	0.19	0.23	—	0.27	0.31	0.35	0.46	0.56	0.69	0.79	—	—
20	Carbon steel	—	0.49	—	0.55	0.61	0.67	0.86	1.01	1.17	1.32	1.47	1.62
	Aluminum alloy	—	0.41	—	0.47	0.53	0.59	0.78	0.93	1.09	1.24	1.39	1.54
25	Carbon steel	—	0.69	—	0.77	0.85	0.93	1.21	1.41	1.63	1.83	2.03	2.23
	Aluminum alloy	—	0.57	—	0.65	0.73	0.81	1.08	1.28	1.50	1.70	1.90	2.10
32	Carbon steel	—	—	1.07	—	—	1.33	1.66	1.92	2.21	2.48	2.75	3.01
	Aluminum alloy	—	—	0.87	—	—	1.14	1.46	1.73	2.01	2.28	2.55	2.81
40	Carbon steel	—	—	1.37	—	—	1.68	2.04	2.35	2.66	2.97	3.27	3.58
	Aluminum alloy	—	—	1.14	—	—	1.45	1.81	2.12	2.43	2.73	3.04	3.35
50	Carbon steel	—	—	2.35	—	—	2.82	3.38	3.85	4.32	4.78	5.25	5.72
	Aluminum alloy	—	—	1.86	—	—	2.33	2.89	3.36	3.82	4.29	4.76	5.22

Allowable Rotational Torque of Plate

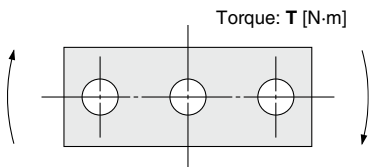

Bore size [mm]	Standard stroke [mm]											
	10	20	25	30	40	50	75	100	125	150	175	200
12	0.39	0.32	—	0.27	0.24	0.21	0.43	0.36	0.31	0.27	—	—
16	0.69	0.58	—	0.49	0.43	0.38	0.69	0.58	0.5	0.44	—	—
20	—	1.05	—	0.93	0.83	0.75	1.88	1.63	1.44	1.28	1.16	1.06
25	—	1.76	—	1.55	1.38	1.25	2.96	2.57	2.26	2.02	1.83	1.67
32	—	—	6.35	—	—	5.13	5.69	4.97	4.42	3.98	3.61	3.31
40	—	—	7.00	—	—	5.66	6.27	5.48	4.87	4.38	3.98	3.65
50	—	—	13.00	—	—	10.8	12.00	10.6	9.50	8.60	7.86	7.24

Non-rotating Accuracy of Plate

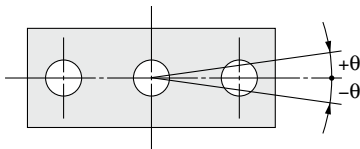

Non-rotating accuracy θ when retracted and when no load is applied should be not more than the values shown in the table.

Bore size [mm]	Non-rotating accuracy θ
12	$\pm 0.07^\circ$
16	
20	$\pm 0.06^\circ$
25	
32	$\pm 0.05^\circ$
40	
50	$\pm 0.04^\circ$

Construction

MGPKM□

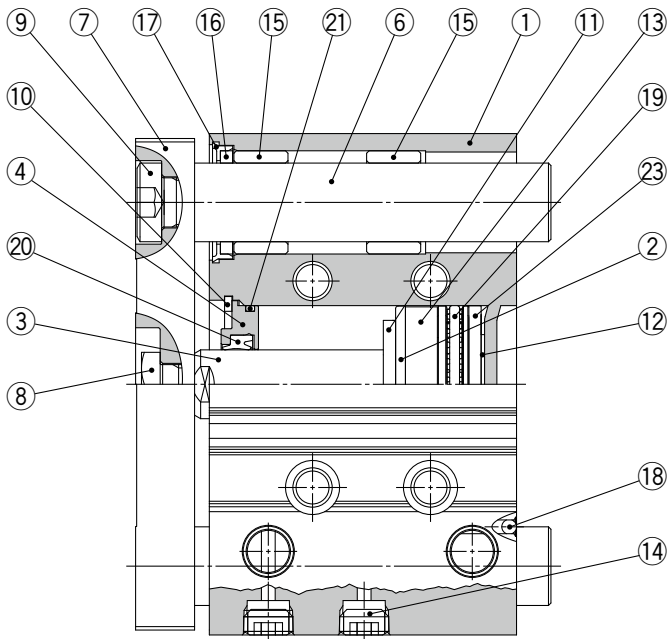

ø12 to ø32 (100 mm stroke or less)

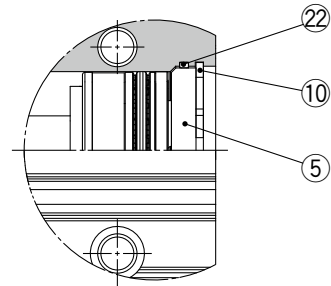

ø12 to ø32 (101 mm stroke or more)
ø40, ø50

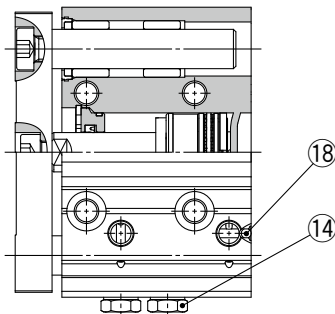

ø12, ø16 Top/Side-ported type

Component Parts

No.	Description	Material	Note
1	Body	Aluminum alloy	Hard anodized
2	Piston	Aluminum alloy	
3	Piston rod	Stainless steel	ø12 to ø25: Hard chrome plating
		Carbon steel	ø32 to ø50: Hard chrome plating
4	Collar	Aluminum alloy	Chromating
5	Head cover	Aluminum alloy	Chromating ø12 to ø32: 101 st or more ø40, ø50
6	Guide rod	Carbon steel	Hard chrome plating
7	Plate	Aluminum alloy	MGPKA Anodized
		Carbon steel	MGPKF Electroless nickel plating
8	Plate mounting bolt	Carbon steel	Nickel plating
9	Guide bolt	Carbon steel	Nickel plating
10	Retaining ring	Carbon tool steel	Phosphate coating
11	Bumper A	Urethane	
12	Bumper B	Urethane	
13	Magnet	—	
14	Plug	Carbon steel	Nickel plating ø12, ø16: Top-ported type
	Hexagon socket head taper plug	Carbon steel	plating ø20 or more
15	Slide bearing	Bearing alloy	
16	Felt	—	
17	Holder	Resin	
18	Steel ball	Carbon steel	ø12, ø16: Top-ported type ø20 or more

Component Parts

No.	Description	Material	Note
19	Piston seal	NBR	
20	Rod seal	NBR	
21	Gasket A	NBR	
22	Gasket B	NBR	ø12 to ø32: 101 st or more ø40, ø50
23	Wear ring	Resin	

Replacement Parts: Seal Kit

Bore size [mm]	Kit no.	Contents
12	MGPK12-PS	Set of nos. ⑱, ⑳, ㉑, ㉒
16	MGPK16-PS	
20	MGPK20-PS	
25	MGPK25-PS	
32	MGPK32-PS	
40	MGPK40-PS	
50	MGPK50-PS	

* The seal kit includes ⑱ to ㉒. Order the seal kit based on each bore size.

* The seal kit does not include a grease pack. Order it separately.

Grease pack part number: GR-S-010 (10 g)

MGPK Series

Dimensions: $\varnothing 12$ to $\varnothing 25$

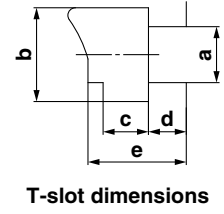
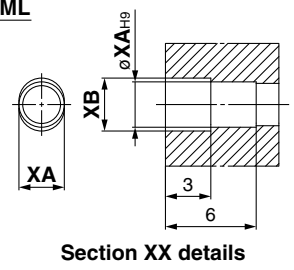
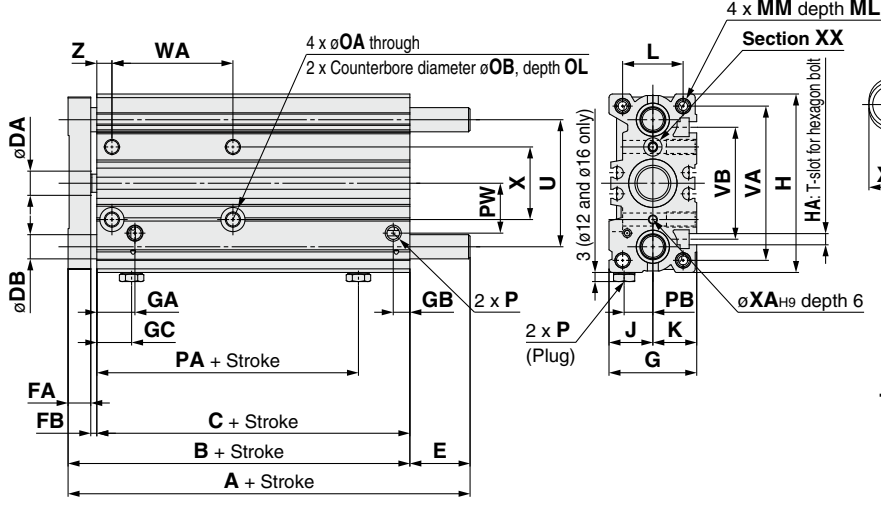
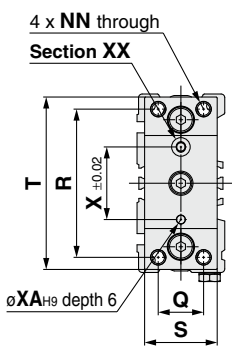
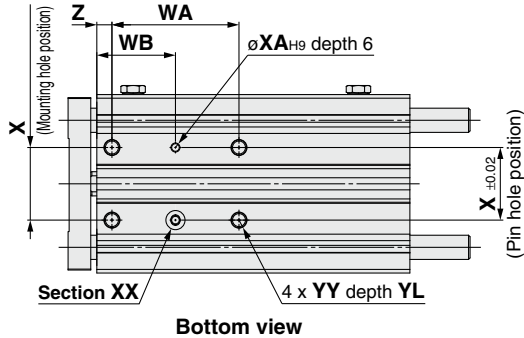

[mm]	
Bore size [mm]	f
12	7
16	2.5
20	8.5
25	6

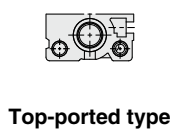
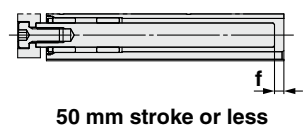

[mm]					
Bore size [mm]	a	b	c	d	e
12	3.3	5.8	2.6	1.6	4.8
16	3.7	6.2	3	2.5	6.5
20	5.4	8.4	4.5	2.8	7.8
25	5.4	8.4	4.5	3	8.2

- * The use of a slot (width XA, length XB, depth 3) allows for a relaxed pin pitch tolerance, with the pin hole ($\varnothing XAH_9$, depth 6) as the reference, without affecting mounting accuracy.
- * For intermediate strokes other than standard strokes, refer to the "Manufacturing of Intermediate Strokes" on page 4.
- * For bore sizes $\varnothing 12$ and $\varnothing 16$, only M5 x 0.8 port is available.
- * For bore size $\varnothing 20$ or more, choice of Rc, NPT, G port is available. (Refer to page 3.)

Bore size [mm]	Standard stroke	[mm]												FA	FB
		A			B		C		DA	DB	E				
		50 st or less	Over 50 st 100 st or less	Over 100 st	100 st or less	Over 100 st	100 st or less	Over 100 st			50 st or less	Over 50 st 100 st or less	Over 100 st		
12	10, 20, 30, 40, 50	36.5	53	75	36.5	39	27.5	30	6	8	0	16.5	36	7	2
16	75, 100, 125, 150	38	58	86	38	41	28.5	31.5	8	8	0	20	45	7.5	2
20	20, 30, 40, 50, 75, 100	50.5	75.5		50.5	52.5	39	41	10	10	0	25	23	9	2.5
25	125, 150, 175, 200	50.5	77		50.5	53.5	37.5	40.5	10	14	0	26.5	23.5	10	3

Bore size [mm]	G	GA	GB		GC	H	HA	J	K	L	MM	ML	NN	OA	OB	OL	P			PA	PB	PW	Q
			100 st or less	Over 100 st													Nil	TN	TF				
			10 st or less	Over 10 st 30 st or less																			
12	25	10	6	7	10	54	M5	12.5	12.5	17	M4 x 0.7	10	M4 x 0.7	4.3	8	4.5	M5 x 0.8			11.5	8	16	14
16	29	12.5	5.5	7.5	11.5	59	M3.5	14.5	14.5	20	M5 x 0.8	11	M5 x 0.8	4.3	8	4.5	M5 x 0.8			11.5	9.5	16.5	15
20	33	12.5	9.5	9.5	12.5	78	M5	16.5	16.5	23	M5 x 0.8	13	M5 x 0.8	5.4	9.5	5.5	Rc1/8	NPT1/8	G1/8	15.5	8.5	25	18
25	38	11.5	9.5	12.5	11.5	90	M5	19	19	27	M6 x 1	15	M6 x 1	5.4	9.5	7	Rc1/8	NPT1/8	G1/8	12.5	11	30	22

Bore size [mm]	R	S	T	U	VA	VB	WA				WB			X	XA	XB	YY	YL	Z	
							10 st or less	Over 10 st 30 st or less	Over 30 st 100 st or less	Over 100 st	10 st or less	Over 10 st 30 st or less	Over 30 st 100 st or less							Over 100 st
							12	43	22	50	37	47	33							20
16	49	24	57	42	51	37	20	22	42	110	15	16	26	60	24	3	3.5	M5 x 0.8	10	5
20	60	28.5	71	49	66	44	24				44			28	3	3.5	M5 x 0.8	10	18	
25	73	34	86	60	78	50	24				44			34	4	4.5	M6 x 1	12	17	

Dimensions: $\varnothing 32$ to $\varnothing 50$

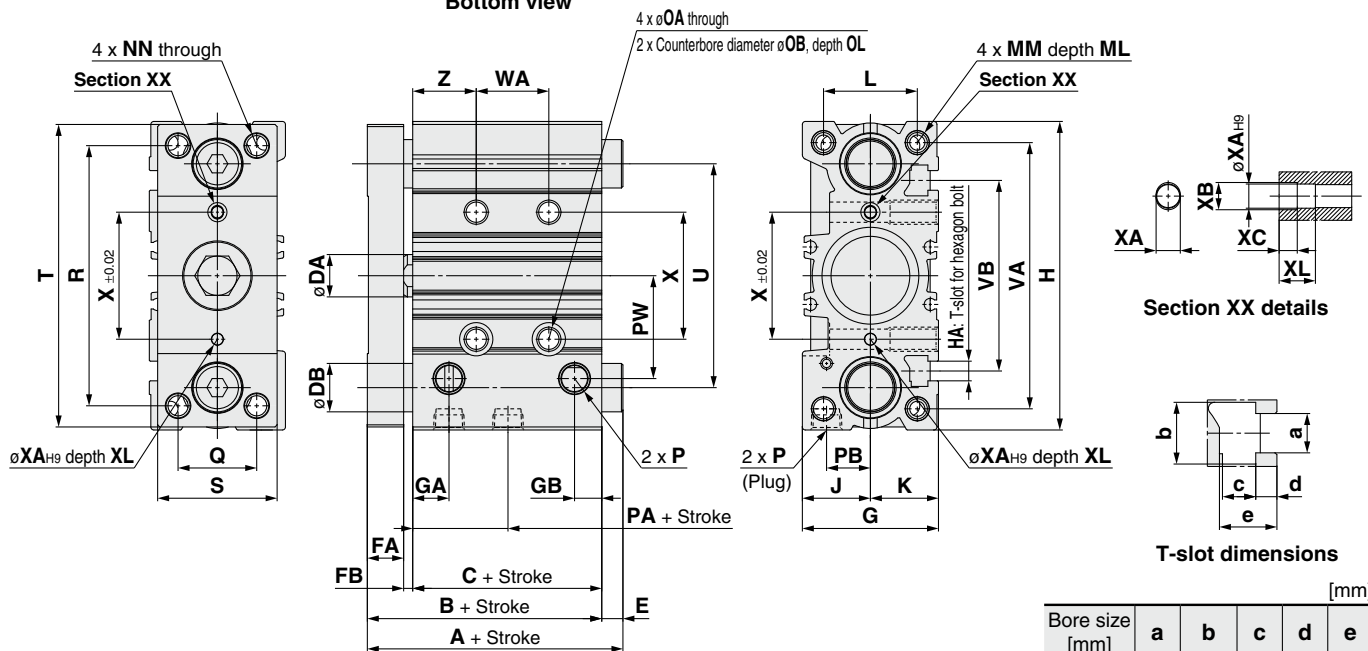
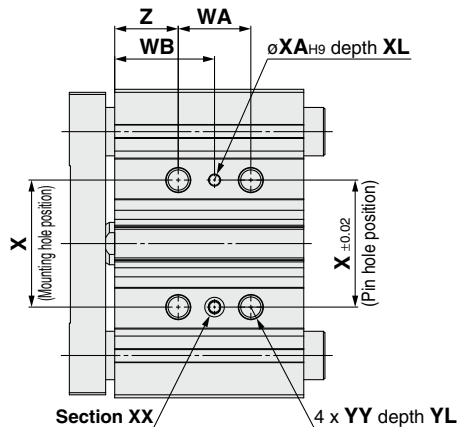
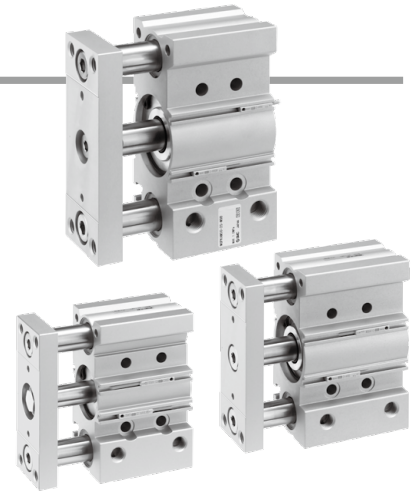

[mm]					
Bore size [mm]	a	b	c	d	e
32	6.5	10.2	5.5	3.5	9.5
40	6.5	10.5	5.5	4	10
50	8.5	12.5	7.5	4	12.5

- * The use of a slot (width XA, length XB, depth XC) allows for a relaxed pin pitch tolerance, with the pin hole ($\varnothing XA_{H9}$, depth XL) as the reference, without affecting mounting accuracy.
- * For intermediate strokes other than standard strokes, refer to the "Manufacturing of Intermediate Strokes" on page 4.
- * Choice of Rc, NPT, G port is available. (Refer to page 3.)

Bore size [mm]	Standard stroke	A		B		C		DA	DB	E			FA	FB	G	GA
		50 st or less	Over 50 st	100 st or less	Over 100 st	100 st or less	Over 100 st			50 st or less	Over 50 st or less	Over 100 st				
		32	25, 50, 75, 100, 125, 150, 175, 200	60	78	52.5	55			37.5	40	14				
40	69	87		64		47		16	16	5	23		12	5	49	15
50	79	100		69		48		20	20	10	31		16	5	59	15

Bore size [mm]	GB	H	HA	J	K	L	MM			NN	OA	OB	OL	P			PA	PB	PW	Q	R	S	T	U	VA	VB			
							M8 x 1.25	20	M8 x 1.25					6.7	11	9											NiI	TN	TF
							32	9	102					M6	22.5	22.5													
40	12	112	M6	24.5	24.5	35	M8 x 1.25	20	M8 x 1.25	6.7	11	9	Rc1/8	NPT1/8	G1/8	16	16.5	41	28	92	42	106	82	98	72				
50	12	140	M8	29.5	29.5	43	M10 x 1.5	22	M10 x 1.5	8.6	14	9	Rc1/4	NPT1/4	G1/4	13	19	49	35	115	52.5	133	104	122	92				

Bore size [mm]	WA			WB			X	XA	XB	XC	XL	YY	YL	Z
	25 st or less	Over 25 st or less	Over 100 st	25 st or less	Over 25 st or less	Over 100 st								
	32	24	48	124	33	45								
40	24	48	124	34	46	84	50	4	4.5	3	6	M8 x 1.25	16	22
50	24	48	124	36	48	86	66	5	6	4	8	M10 x 1.5	20	24

MGPK Series Model Selection

Selection Conditions

Mounting orientation	Vertical		Horizontal	
	200 or less	400	200 or less	400
Max. speed [mm/s]	200 or less	400	200 or less	400
Plate material	Carbon steel	1, 2	5, 6	7, 8
	Aluminum alloy	9, 10	11, 12	13, 14

Selection Example 1 (Vertical Mounting)

Selection conditions

Mounting: Vertical
Stroke: 30 mm stroke
Max. speed: 200 mm/s
Load mass: 2 kg
Eccentric distance: 80 mm

Find the point of intersection for the load mass of 2 kg and the eccentric distance of 80 mm on graph **1**, based on vertical mounting, 30 mm stroke, and the speed of 200 mm/s.

→ The **MGPKFM16-30** should be selected.

1 50 mm stroke or less, V = 200 mm/s or less

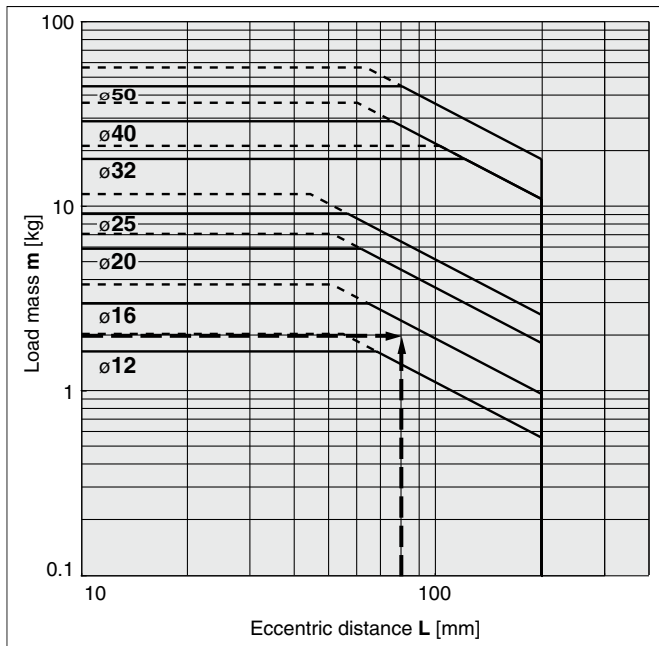

Selection Example 2 (Horizontal Mounting)

Selection conditions

Mounting: Horizontal
Distance between plate and load center of gravity: 50 mm
Max. speed: 200 mm/s
Load mass: 10 kg
Stroke: 25 mm stroke

Find the point of intersection for the load mass of 10 kg and 25 mm stroke on graph **5**, based on horizontal mounting, the distance of 50 mm between the plate and load center of gravity, and the speed of 200 mm/s.

→ The **MGPKFM32-25** should be selected.

5 L = 50 mm, V = 200 mm/s or less

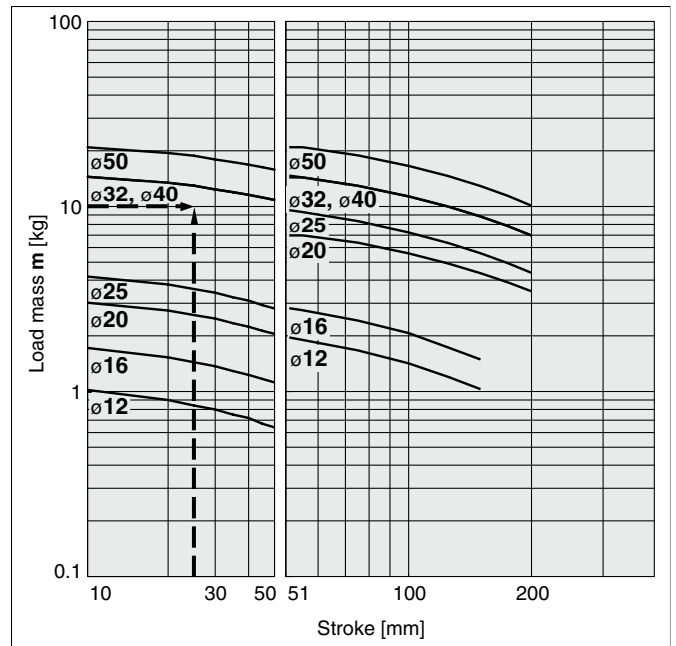

When the max. speed exceeds 200 mm/s, the allowable load mass is determined by multiplying the value shown in the graph at 400 mm/s by the coefficient listed in the table below.

Max. speed	Up to 300 mm/s	Up to 400 mm/s	Up to 500 mm/s
Coefficient	1.7	1	0.6

Vertical Mounting

Plate Material **Carbon Steel**

—— Operating pressure: 0.4 MPa - - - - - Operating pressure: 0.5 MPa or more

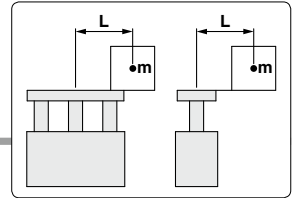

MGPKFM12 to 50

1 50 mm stroke or less, V = 200 mm/s or less

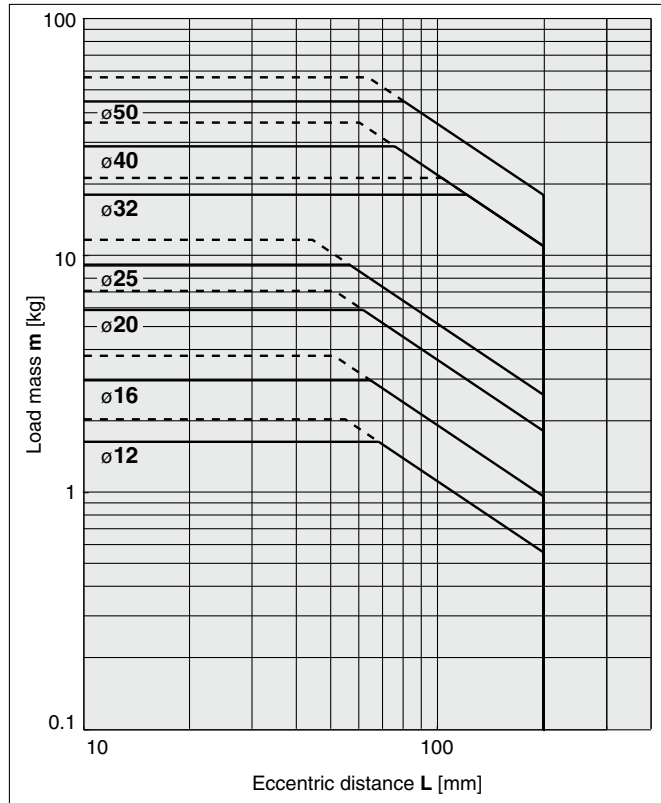

2 Over 50 mm stroke, V = 200 mm/s or less

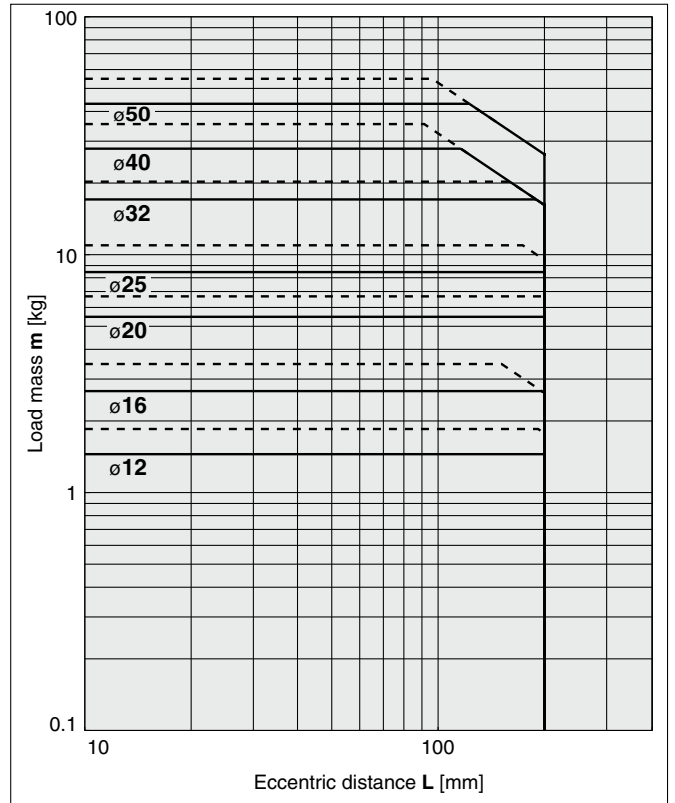

3 50 mm stroke or less, V = 400 mm/s

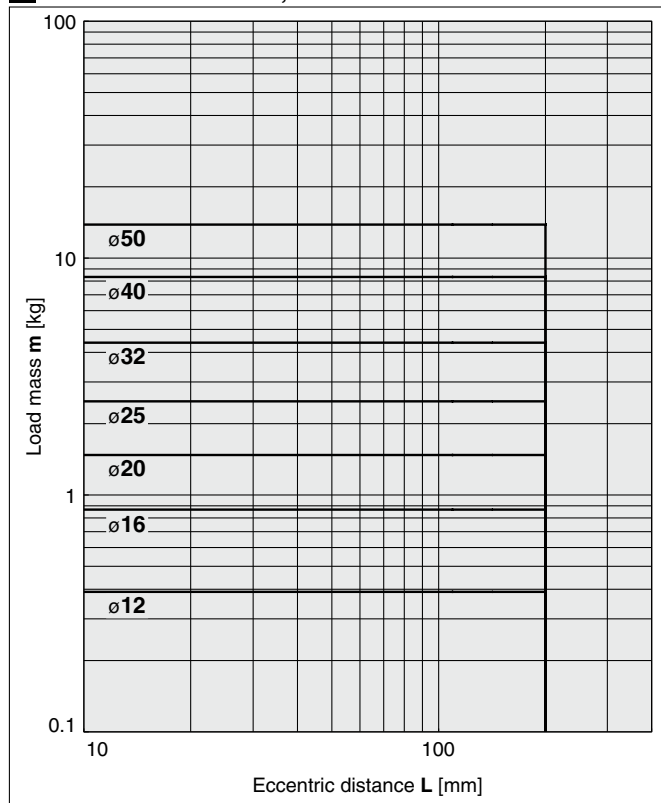

4 Over 50 mm stroke, V = 400 mm/s

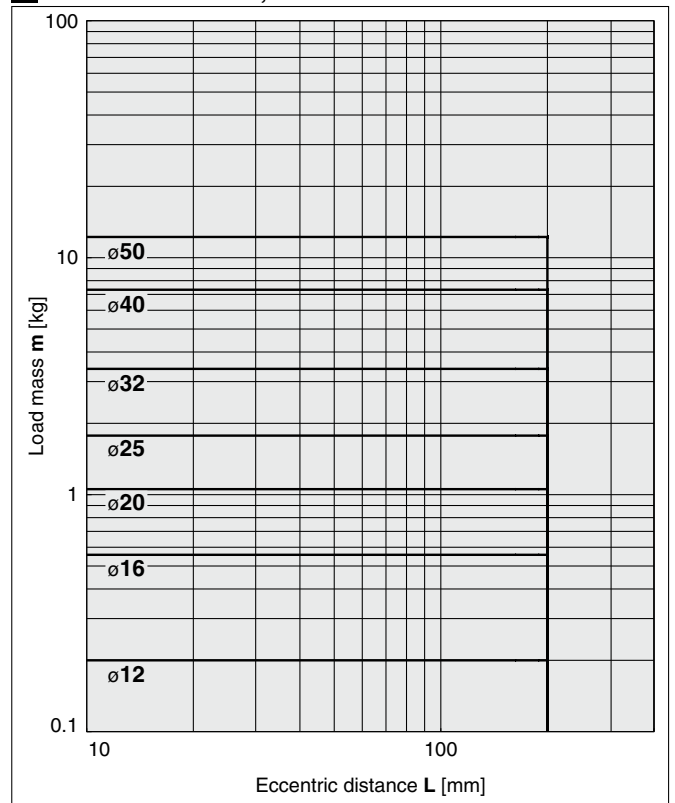

MGPK Series

Horizontal Mounting Plate Material Carbon Steel

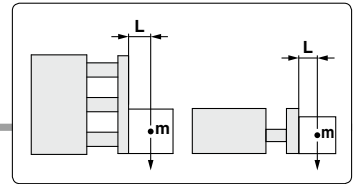

MGPKFM12 to 50

5 L = 50 mm, V = 200 mm/s or less

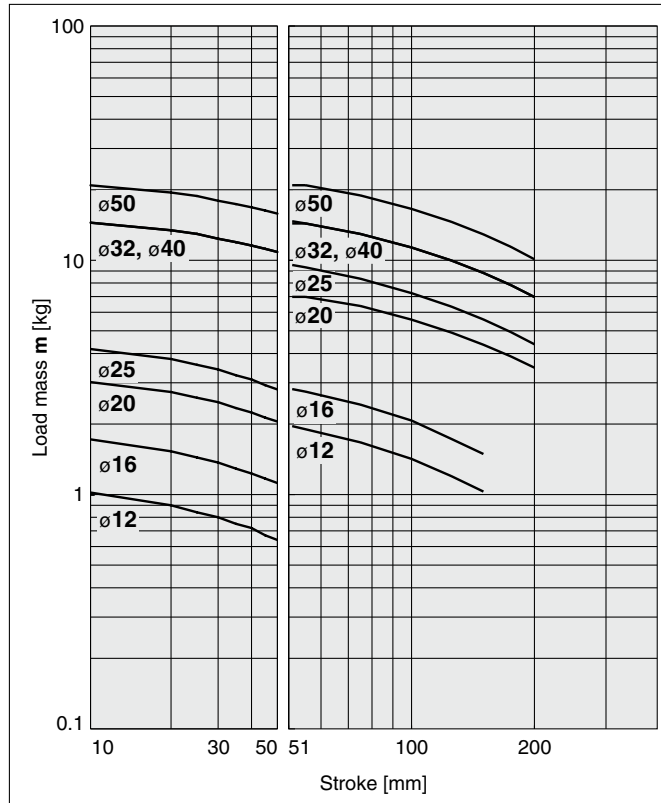

6 L = 100 mm, V = 200 mm/s or less

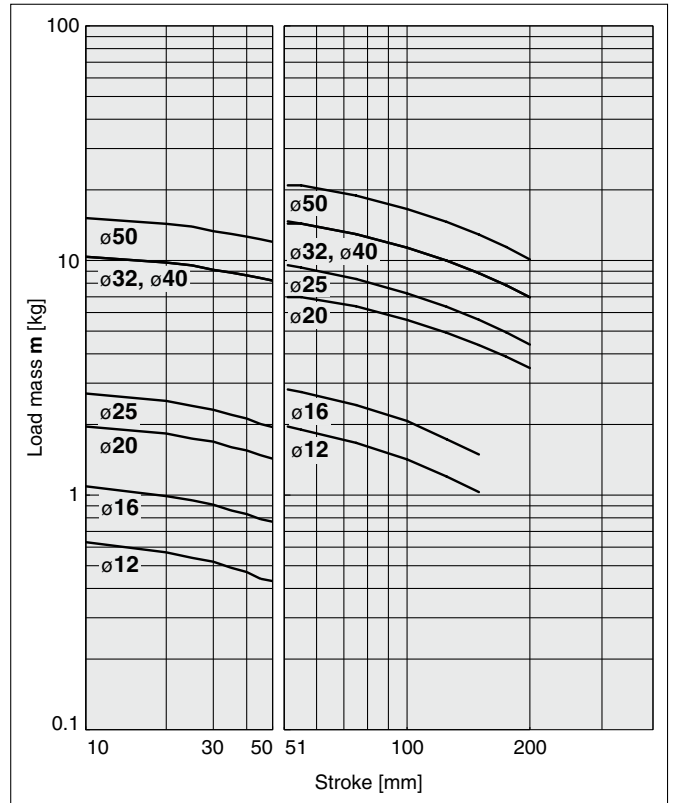

7 L = 50 mm, V = 400 mm/s

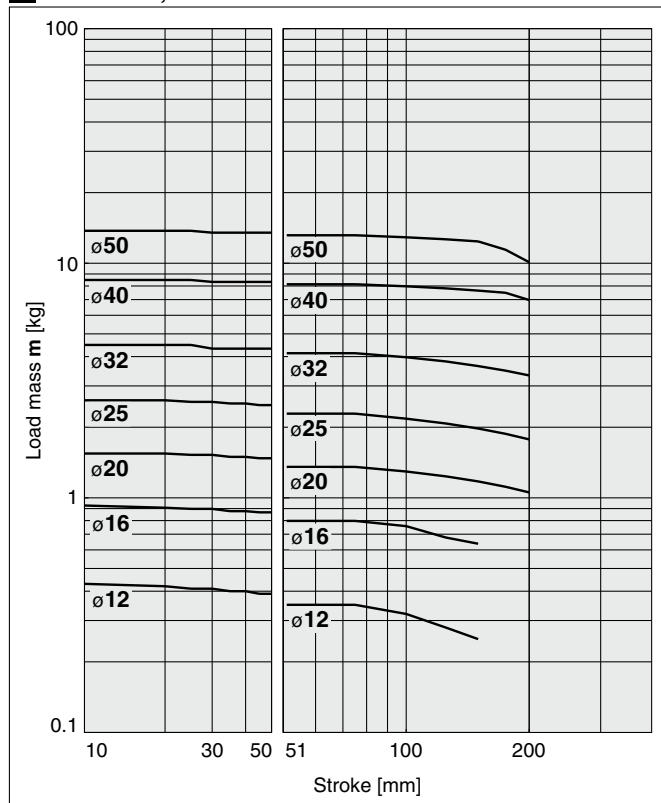

8 L = 100 mm, V = 400 mm/s

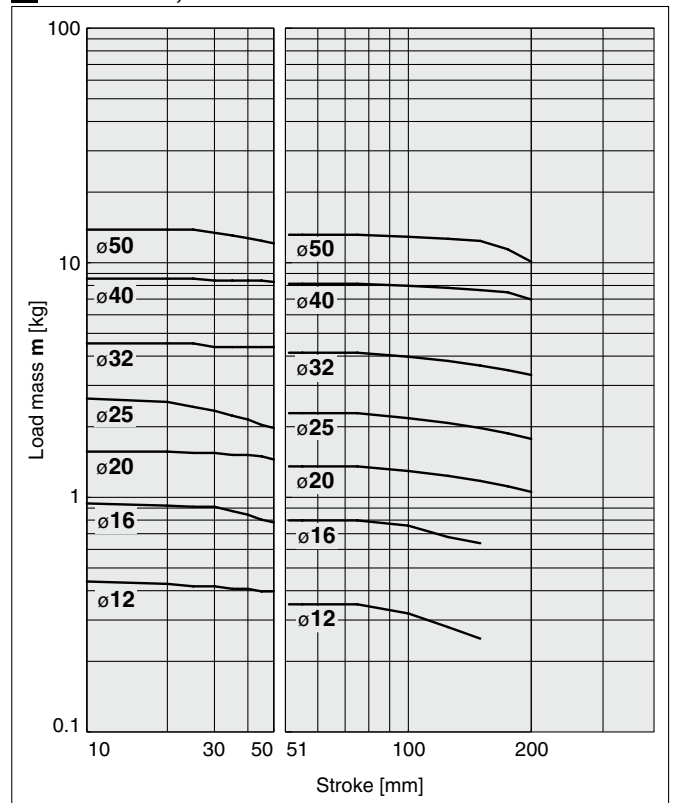

Vertical Mounting

Plate Material **Aluminum Alloy**

—— Operating pressure: 0.4 MPa - - - - - Operating pressure: 0.5 MPa or more

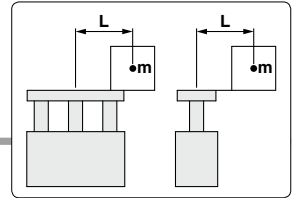

MGPKAM12 to 50

9 50 mm stroke or less, V = 200 mm/s or less

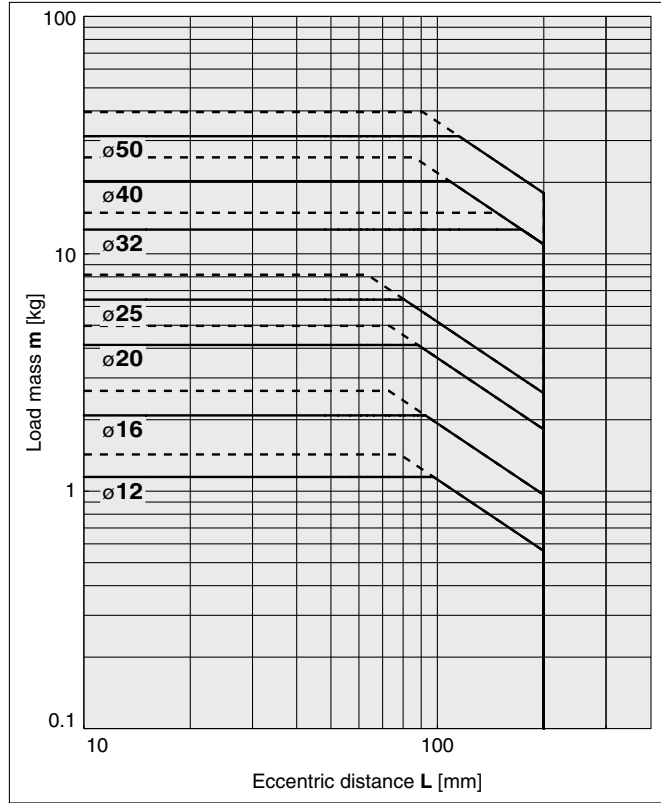

10 Over 50 mm stroke, V = 200 mm/s or less

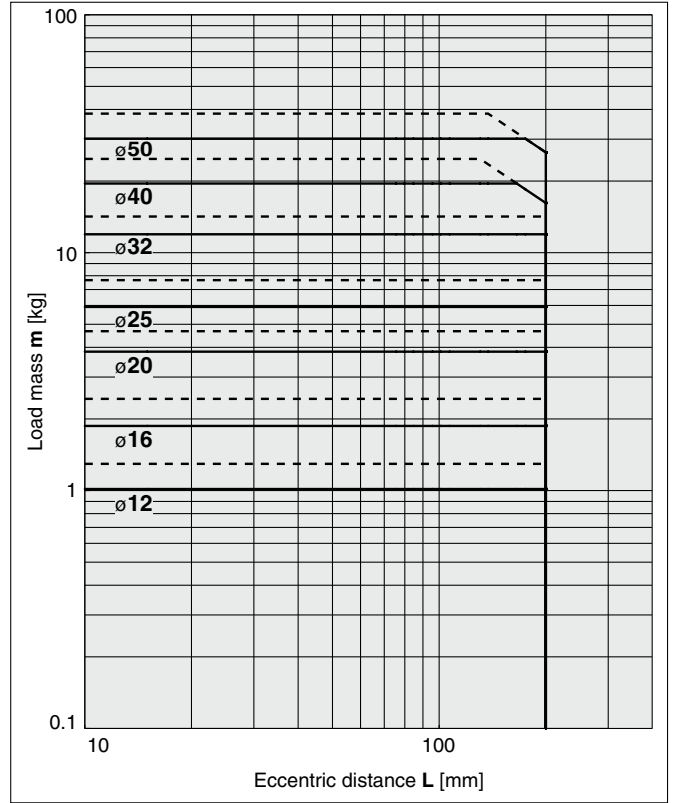

11 50 mm stroke or less, V = 400 mm/s

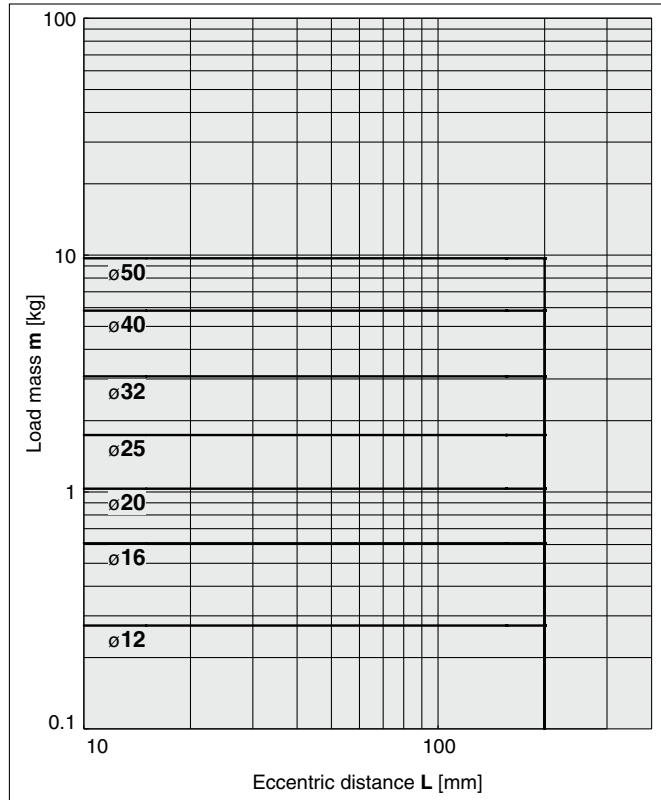

12 Over 50 mm stroke, V = 400 mm/s

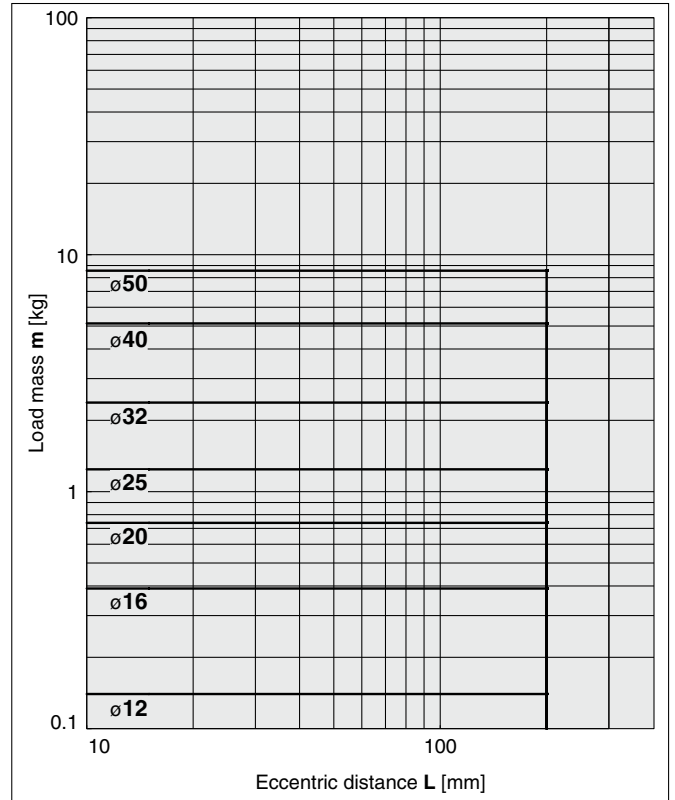

MGPK Series

Horizontal Mounting **Plate Material Aluminum Alloy**

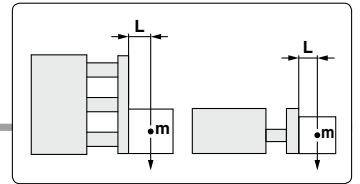

MGPKAM12 to 50

13 L = 50 mm, V = 200 mm/s or less

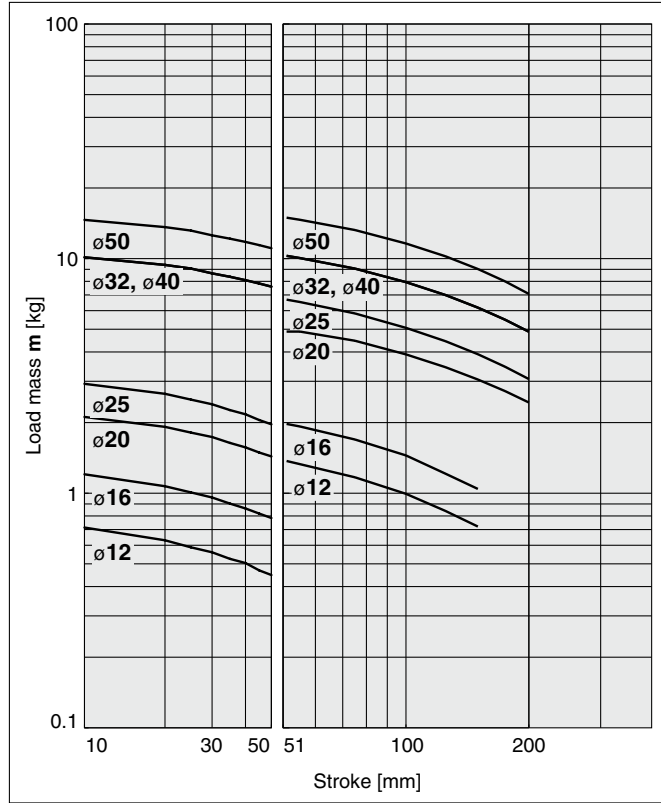

14 L = 100 mm, V = 200 mm/s or less

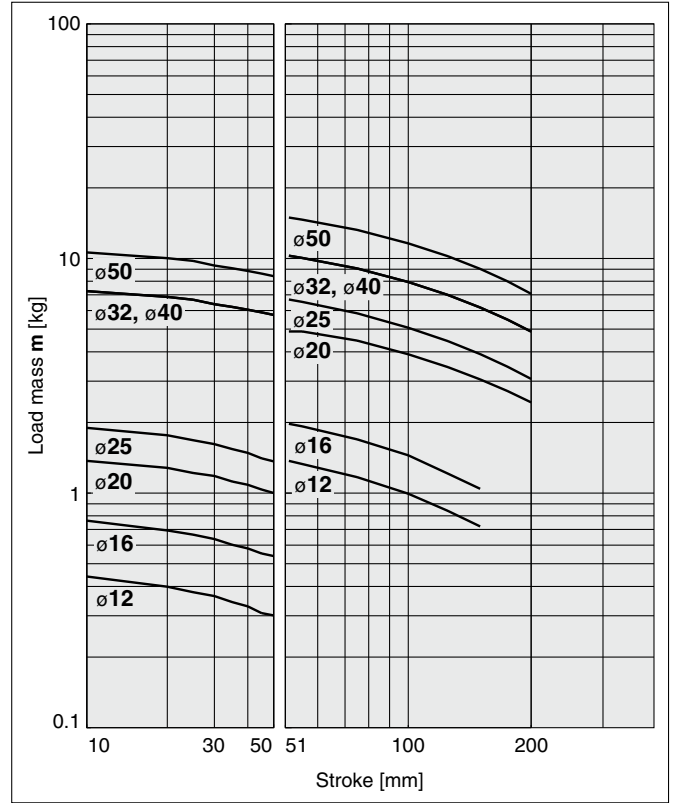

15 L = 50 mm, V = 400 mm/s

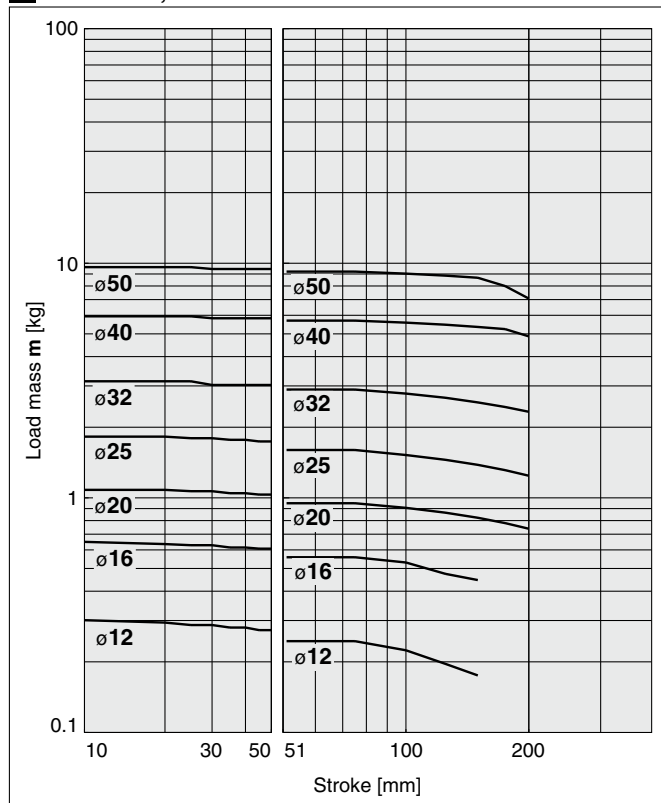

16 L = 100 mm, V = 400 mm/s

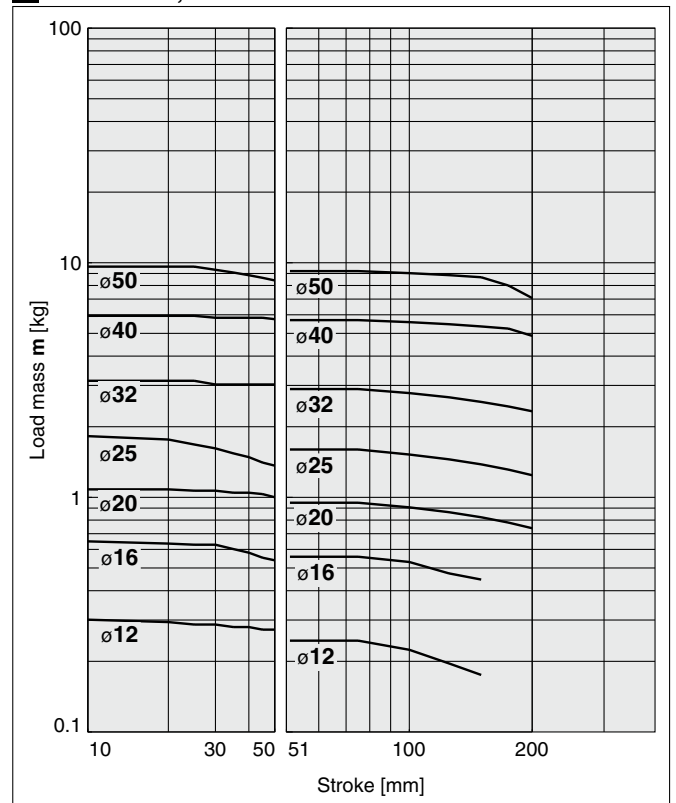

Operating Range when Used as a Stopper

Bore Sizes $\phi 12$ to $\phi 25$ / MGPKFM12 to 25 (Slide bearing)

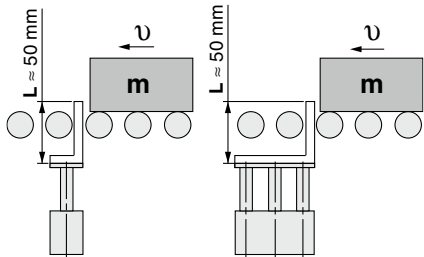

* When selecting a model with a longer **L** dimension, be sure to choose a bore size which is sufficiently large.

Caution

Handling Precautions

1. When used as a stopper, select a model with a stroke of 30 mm or less.
2. The MGPKA (Plate material: Aluminum alloy) cannot be used as a stopper.

MGPKFM12 to 25 (Slide bearing)

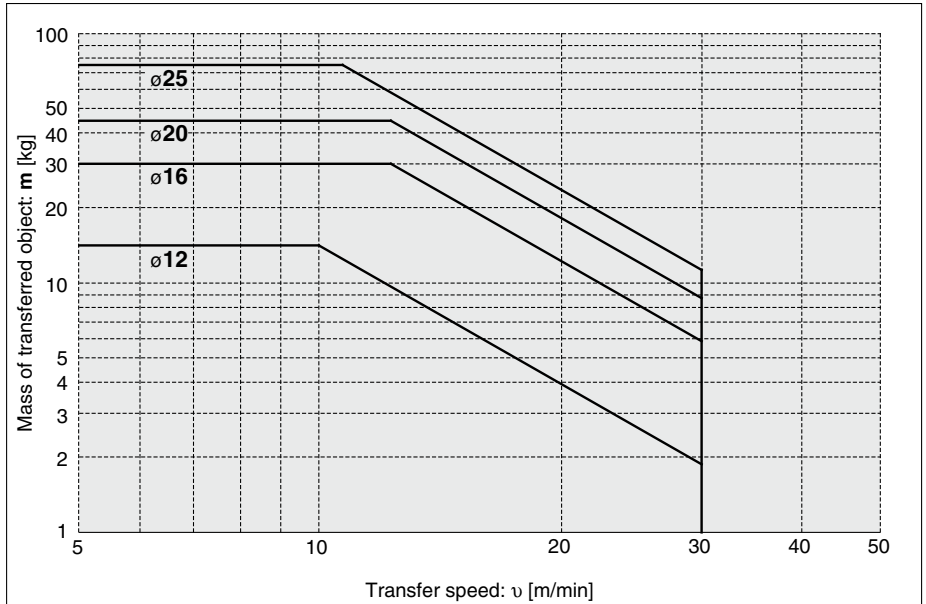

Bore Sizes $\phi 32$ to $\phi 50$ / MGPKFM32 to 50 (Slide bearing)

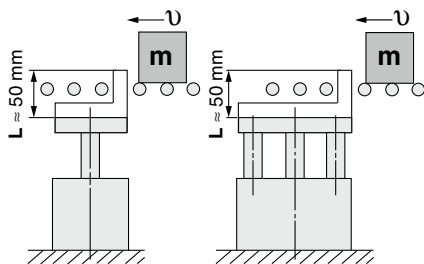

* When selecting a model with a longer **L** dimension, be sure to choose a bore size which is sufficiently large.

Caution

Handling Precautions

1. When used as a stopper, select a model with a stroke of 50 mm or less.
2. The MGPKA (Plate material: Aluminum alloy) cannot be used as a stopper.

MGPKFM32 to 50 (Slide bearing)

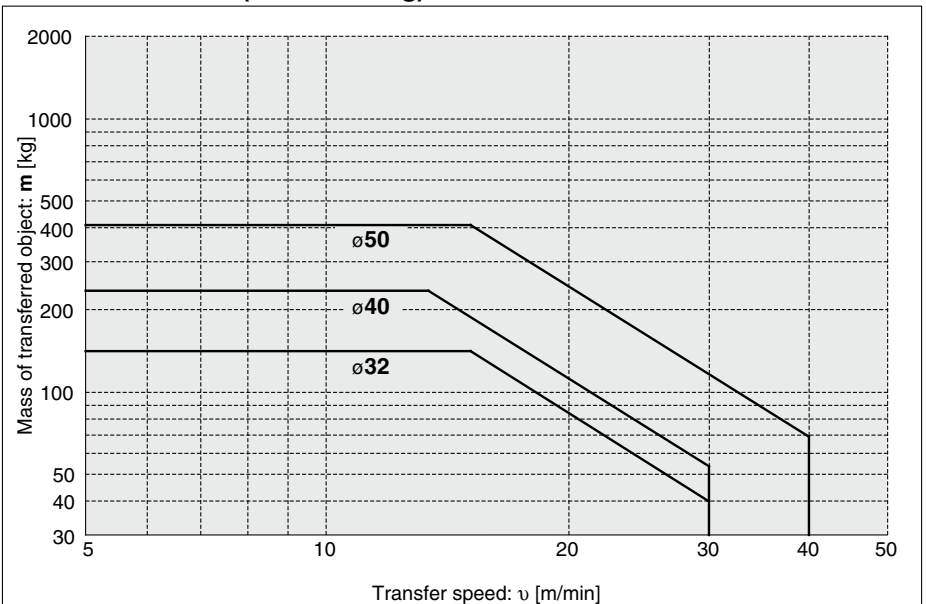

MGPK Series Auto Switch Mounting

Auto Switch Proper Mounting Position (Detection at stroke end) and Mounting Height

D-M9□/M9□V
D-M9□W/M9□WV
D-M9□A/M9□AV
D-A9□/A9□V

ø16, ø32

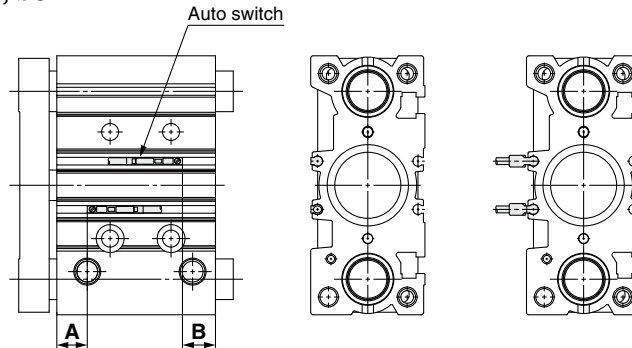

Auto Switch Proper Mounting Position [mm]

Auto switch model	D-M9□ D-M9□W D-M9□A		D-M9□V D-M9□WV D-M9□AV		D-A9□ D-A9□V	
	A	B		A	B	
		100 mm stroke or less	101 mm stroke or more		100 mm stroke or less	101 mm stroke or more
12	7.5	7.5	10	—	—	—
16	9	7.5	10.5	5	3.5	6.5
20	13.5	13.5	15	9.5	9.5	11
25	11.5	14	16.5	7.5	10	12.5
32	12	13	15.5	8	9	11.5
40	15	20	20	11	16	16
50	14.5	21	21	10.5	17	17

Auto Switch Mounting Height [mm]

Auto switch model	D-M9□V D-M9□WV D-M9□AV		D-A9□V	
	Hs	Ht	Hs	Ht
12	19.7	—	—	—
16	21.5	—	19	—
20	23.2	—	20.7	—
25	24.7	—	22.2	—
32	29.5	—	27	—
40	31.2	—	28.7	—
50	34.5	—	32	—

* Adjust the auto switch after confirming the operating conditions in the actual setting.

Min. Stroke for Auto Switch Mounting

Auto switch model	Number of auto switches	ø12	ø16	ø20	ø25	ø32	ø40	ø50
D-M9□V	1	5						
	2	5						
D-M9□	1	5*1					5	
	2	10*1					10	
D-M9□W	1	5*2						
	2	10*2					10	
D-M9□WV D-M9□AV	1	5*2						
	2	10						
D-M9□A	1	5*2						
	2	10*2						
D-A9□	1	—	5*1				5	
	2	—	10*1				10	
D-A9□V	1	—	5					
	2	—	10					

*1 Confirm that it is possible to secure the min. bending radius of 10 mm of the auto switch lead wire before use.

*2 Confirm that it is possible to securely set the auto switch(es) within the range of indicator green light ON range before use.
For the in-line entry type, also consider *1 shown above.

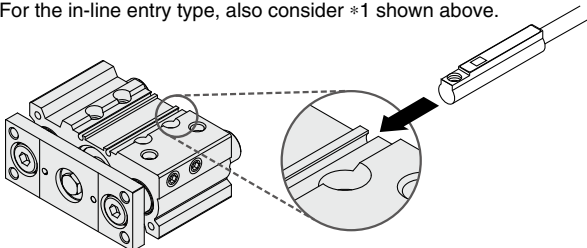

Operating Range

Auto switch model	Bore size [mm]						
	12	16	20	25	32	40	50
D-M9□/M9□V D-M9□W/M9□WV D-M9□A/M9□AV	3.5	3.5	5	5	5.5	6	6
D-A9□/A9□V	—	9	9	9	9.5	9.5	9.5

* Values which include hysteresis are for reference purposes only. They are not a guarantee (assuming approximately ±30% dispersion) and may change substantially depending on the ambient environment.

Auto Switch Mounting

Applicable auto switches	D-M9□/M9□V D-M9□W/M9□WV D-M9□A/M9□AV D-A9□/A9□V	
Bore size [mm]	ø12, ø16, ø20, ø25, ø32, ø40, ø50	
Auto switch tightening torque	[N·m]	
	Auto switch model	Tightening torque
	D-M9□(V) D-M9□W(V) D-A93	0.05 to 0.15
	D-M9□A(V)	0.05 to 0.10
	D-A9□(V) (Excludes the D-A93)	0.10 to 0.20

Prior to Use

Auto Switch Connections and Examples

Sink Input Specifications

3-wire, NPN

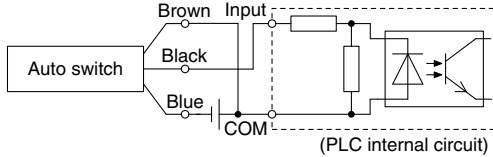

2-wire

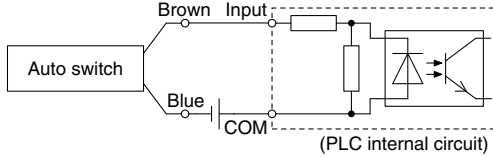

Source Input Specifications

3-wire, PNP

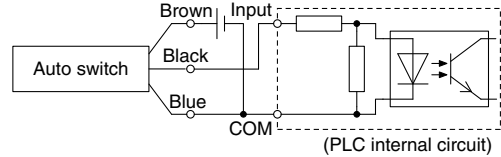

2-wire

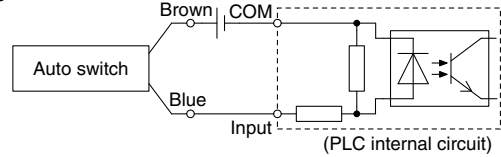

Connect according to the applicable PLC input specifications, as the connection method will vary depending on the PLC input specifications.

Examples of AND (Series) and OR (Parallel) Connections

* When using solid state auto switches, ensure the application is set up so the signals for the first 50 ms are invalid. Depending on the operating environment, the product may not operate properly.

3-wire AND connection for NPN output (Using relays)

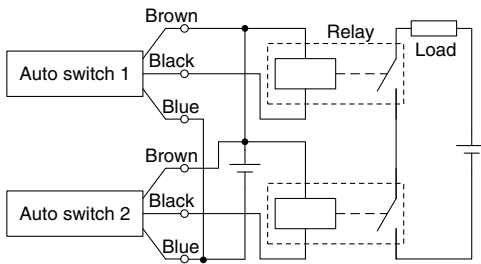

(Performed with auto switches only)

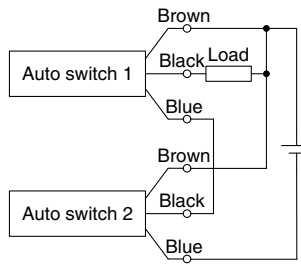

3-wire OR connection for NPN output

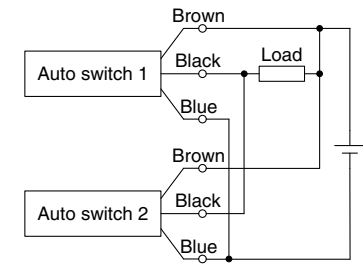

3-wire AND connection for PNP output (Using relays)

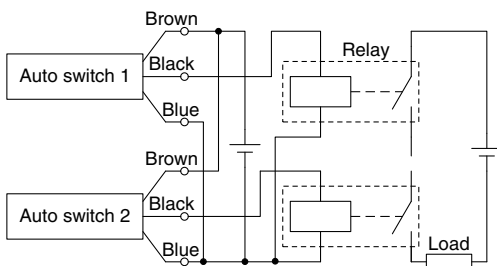

(Performed with auto switches only)

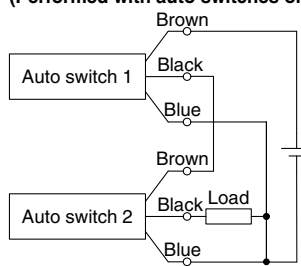

3-wire OR connection for PNP output

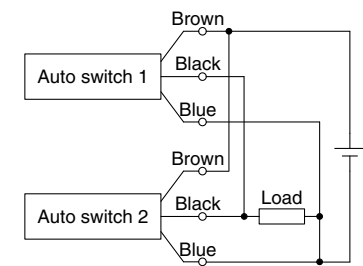

2-wire AND connection

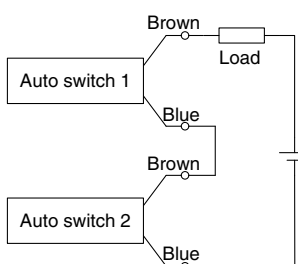

When two auto switches are connected in series, a load may malfunction because the load voltage will decline when in the ON state. The indicator lights will light up when both of the auto switches are in the ON state. Auto switches with a load voltage less than 20 V cannot be used. Please contact SMC if using AND connection for a heat-resistant solid state auto switch or a trimmer switch.

Example) Load voltage at ON
 Power supply voltage: 24 VDC
 Internal voltage drop: 4 V
 Load voltage at ON = Power supply voltage –
 Internal voltage drop x 2 pcs.
 = 24 V – 4 V x 2 pcs.
 = 16 V

2-wire OR connection

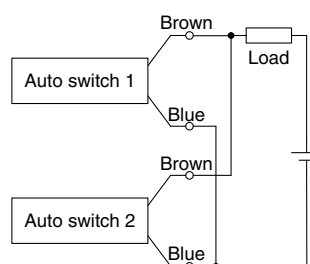

(Solid state)
 When two auto switches are connected in parallel, malfunction may occur because the load voltage will increase when in the OFF state.

(Reed)
 Because there is no current leakage, the load voltage will not increase when turned OFF. However, depending on the number of auto switches in the ON state, the indicator lights may sometimes grow dim or not light up, due to the dispersion and reduction of the current flowing to the auto switches.

Example) Load voltage at OFF
 Leakage current: 1 mA
 Load impedance: 3 kΩ
 Load voltage at OFF = Leakage current x 2 pcs. x
 Load impedance
 = 1 mA x 2 pcs. x 3 kΩ
 = 6 V



MGPK Series Specific Product Precautions 1

Be sure to read this before handling the products. Refer to the back cover for safety instructions. For actuator and auto switch precautions, refer to the “Handling Precautions for SMC Products” and the “Operation Manual” on the SMC website: <https://www.smcworld.com>

Mounting

Warning

1. Never place your hands or fingers between the plate and the body.

Be very careful to prevent your hands or fingers from getting caught in the gap between the cylinder body and the plate when air is applied.

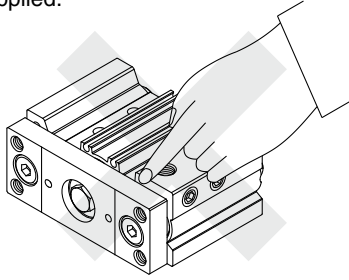

Caution

1. Use cylinders within the piston speed range.

An orifice is set for this cylinder, but the piston speed may exceed the operating range if the speed controller is not used. If the cylinder is used outside the operating speed range, it may cause damage to the cylinder and shorten the service life. Adjust the speed by installing the speed controller and use the cylinder within the limited range.

2. Pay attention to the operating speed when the product is mounted vertically.

When using the product in the vertical direction, if the load factor is large, the operating speed can be faster than the control speed of the speed controller (i.e. quick extension). In such cases, it is recommended to use a dual speed controller.

3. Do not scratch or gouge the sliding portion of the piston rod and the guide rod.

Damaged seals etc., will result in leakage or malfunction.

4. Do not dent or scratch the mounting surface of the body and the plate.

This may cause a decrease in the flatness of the mounting surface, which will cause an increase in sliding resistance.

5. Make sure that the cylinder mounting surface has a flatness of 0.05 mm or less.

If the flatness of the workpieces and brackets mounted on the plate is not appropriate, sliding resistance may increase. If it is difficult to maintain a flatness of 0.05 mm or less, put a thin shim ring (provided by the customer) between the plate and the workpiece mounting surface to prevent the sliding resistance from increasing.

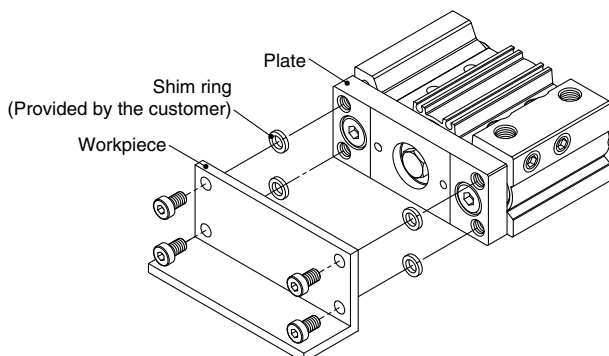

Mounting

Caution

6. Cylinder bottom

Since the guide rods project from the bottom of the cylinder at the end of the retraction stroke, provide bypass ports in the mounting surface, as well as holes for the hexagon socket head mounting screws, when the cylinder is mounted from the bottom.

Furthermore, when subjected to impact in use as a stopper, etc., screw the mounting bolts in to a depth of 2d or more.

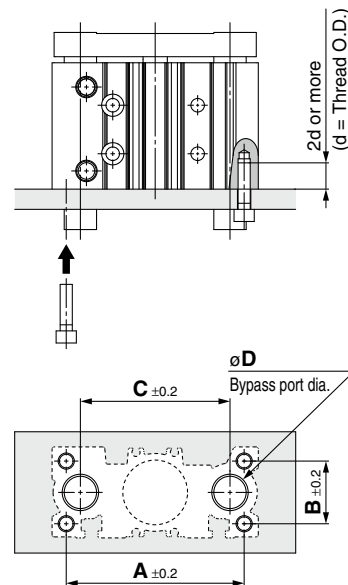

Bore size [mm]	[mm]			
	A	B	C	D
12	47	17	37	10
16	51	20	42	10
20	66	23	49	12
25	78	27	60	16
32	88	31	74	18
40	98	35	82	18
50	122	43	104	22



MGPK Series

Specific Product Precautions 2

Be sure to read this before handling the products. Refer to the back cover for safety instructions. For actuator and auto switch precautions, refer to the “Handling Precautions for SMC Products” and the “Operation Manual” on the SMC website: <https://www.smcworld.com>

Piping

⚠ Caution

Depending on the operating conditions, change the position of the piping port plugs. When changing the port position, reassemble the removed plug. When reusing the removed plug, use a sealant on the plug before reassembly. Before piping to the port from which the plug was removed, make sure there is no foreign matter adhering to the port.

Refer to the following for the proper tightening torque of the plug.

1. M5

After tightening by hand, tighten an additional 1/6 to 1/4 turn with a tightening tool.

2. Tapered thread for Rc port (MGPK□) and NPT port (MGPK□TN)

Tighten with the proper tightening torque below. Also, use sealant tape on the plugs. With regard to the sunk dimension of the plugs (“a” dimension in the drawing), use the stipulated figures as a guide and confirm that there is no air leakage before operation.

* If the plugs on the top mounting port are tightened with more than the proper tightening torque, they will be screwed in too deeply and the air passage will be constricted, resulting in limited cylinder speed.

Connection thread (plug) size	Proper tightening torque [N·m]	a dimension
1/8	7 to 9	0.5 mm or less
1/4	12 to 14	1 mm or less
3/8	22 to 24	1 mm or less

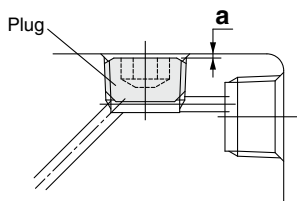

3. Parallel pipe thread for G port (MGPK□□TF)

Screw the plugs into the surface of the body (“a” dimension in the drawing), and confirm the position visually instead of using the tightening torque shown in the table.

Allowable Kinetic Energy

⚠ Caution

The load mass and a max. speed must be within the ranges shown below.

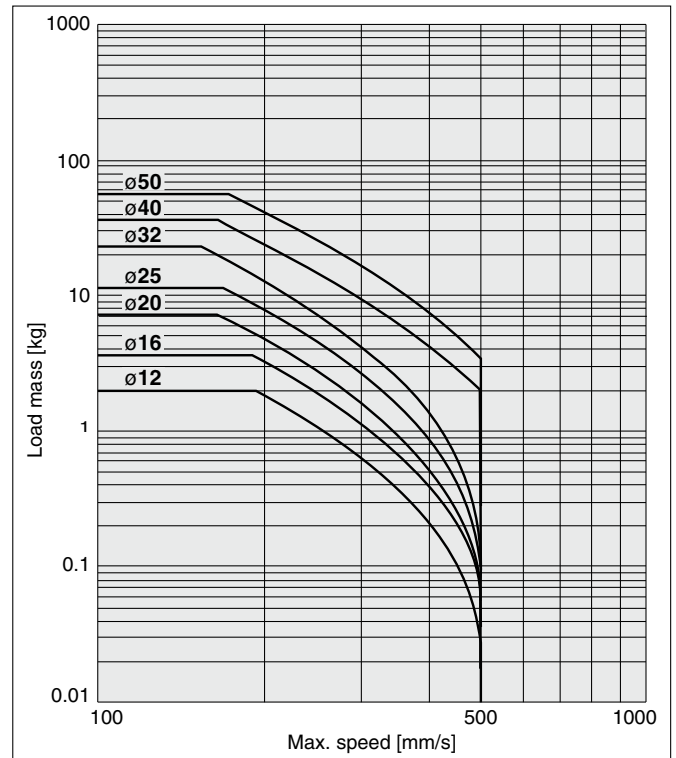

Safety Instructions

These safety instructions are intended to prevent hazardous situations and/or equipment damage. These instructions indicate the level of potential hazard with the labels of “**Caution**,” “**Warning**” or “**Danger**.” They are all important notes for safety and must be followed in addition to International Standards (ISO/IEC)*1), and other safety regulations.

 **Caution:** **Caution** indicates a hazard with a low level of risk which, if not avoided, could result in minor or moderate injury.

 **Warning:** **Warning** indicates a hazard with a medium level of risk which, if not avoided, could result in death or serious injury.

 **Danger :** **Danger** indicates a hazard with a high level of risk which, if not avoided, will result in death or serious injury.

*1) ISO 4414: Pneumatic fluid power – General rules relating to systems.
ISO 4413: Hydraulic fluid power – General rules relating to systems.
IEC 60204-1: Safety of machinery – Electrical equipment of machines.
(Part 1: General requirements)
ISO 10218-1: Manipulating industrial robots – Safety.
etc.

Warning

1. The compatibility of the product is the responsibility of the person who designs the equipment or decides its specifications.

Since the product specified here is used under various operating conditions, its compatibility with specific equipment must be decided by the person who designs the equipment or decides its specifications based on necessary analysis and test results. The expected performance and safety assurance of the equipment will be the responsibility of the person who has determined its compatibility with the product. This person should also continuously review all specifications of the product referring to its latest catalog information, with a view to giving due consideration to any possibility of equipment failure when configuring the equipment.

2. Only personnel with appropriate training should operate machinery and equipment.

The product specified here may become unsafe if handled incorrectly. The assembly, operation and maintenance of machines or equipment including our products must be performed by an operator who is appropriately trained and experienced.

3. Do not service or attempt to remove product and machinery/equipment until safety is confirmed.

1. The inspection and maintenance of machinery/equipment should only be performed after measures to prevent falling or runaway of the driven objects have been confirmed.
2. When the product is to be removed, confirm that the safety measures as mentioned above are implemented and the power from any appropriate source is cut, and read and understand the specific product precautions of all relevant products carefully.
3. Before machinery/equipment is restarted, take measures to prevent unexpected operation and malfunction.

4. Contact SMC beforehand and take special consideration of safety measures if the product is to be used in any of the following conditions.

1. Conditions and environments outside of the given specifications, or use outdoors or in a place exposed to direct sunlight.
2. Installation on equipment in conjunction with atomic energy, railways, air navigation, space, shipping, vehicles, military, medical treatment, combustion and recreation, or equipment in contact with food and beverages, emergency stop circuits, clutch and brake circuits in press applications, safety equipment or other applications unsuitable for the standard specifications described in the product catalog.
3. An application which could have negative effects on people, property, or animals requiring special safety analysis.
4. Use in an interlock circuit, which requires the provision of double interlock for possible failure by using a mechanical protective function, and periodical checks to confirm proper operation.

Caution

1. The product is provided for use in manufacturing industries.

The product herein described is basically provided for peaceful use in manufacturing industries.
If considering using the product in other industries, consult SMC beforehand and exchange specifications or a contract if necessary.
If anything is unclear, contact your nearest sales branch.

Limited warranty and Disclaimer/ Compliance Requirements

The product used is subject to the following “Limited warranty and Disclaimer” and “Compliance Requirements”.

Read and accept them before using the product.

Limited warranty and Disclaimer

1. The warranty period of the product is 1 year in service or 1.5 years after the product is delivered, whichever is first.*2)
Also, the product may have specified durability, running distance or replacement parts. Please consult your nearest sales branch.
2. For any failure or damage reported within the warranty period which is clearly our responsibility, a replacement product or necessary parts will be provided.
This limited warranty applies only to our product independently, and not to any other damage incurred due to the failure of the product.
3. Prior to using SMC products, please read and understand the warranty terms and disclaimers noted in the specified catalog for the particular products.

*2) Vacuum pads are excluded from this 1 year warranty.

A vacuum pad is a consumable part, so it is warranted for a year after it is delivered.
Also, even within the warranty period, the wear of a product due to the use of the vacuum pad or failure due to the deterioration of rubber material are not covered by the limited warranty.

Compliance Requirements

1. The use of SMC products with production equipment for the manufacture of weapons of mass destruction (WMD) or any other weapon is strictly prohibited.
2. The exports of SMC products or technology from one country to another are governed by the relevant security laws and regulations of the countries involved in the transaction. Prior to the shipment of a SMC product to another country, assure that all local rules governing that export are known and followed.

Caution

SMC products are not intended for use as instruments for legal metrology.

Measurement instruments that SMC manufactures or sells have not been qualified by type approval tests relevant to the metrology (measurement) laws of each country. Therefore, SMC products cannot be used for business or certification ordained by the metrology (measurement) laws of each country.

Revision History

Edition B * Bore sizes $\phi 12$, $\phi 20$, $\phi 25$, $\phi 40$, and $\phi 50$ have been added.

BP

Safety Instructions

Be sure to read the “Handling Precautions for SMC Products” (M-E03-3) and “Operation Manual” before use.

SMC Corporation

Akihabara UDX 15F,
4-14-1, Sotokanda, Chiyoda-ku, Tokyo 101-0021, JAPAN
Phone: 03-5207-8249 Fax: 03-5298-5362
<https://www.smcworld.com>
© 2023 SMC Corporation All Rights Reserved

Specifications are subject to change without prior notice
and any obligation on the part of the manufacturer.

D-G