

# Vacuum Manifold for Fieldbus System



New



Ejector System

IP65

## Fieldbus-compatible

- Space saving: Requires no separate input/output units
- Reduced wiring time
- Compatible protocol   IO-Link

## New Exhaust sealing function

- Vacuum release flow rate increased by 2 times  
(Under SMC's measurement conditions)
- High release pressure allows for the quick release of workpieces.

## Vacuum Ejector

### Air consumption

# 90% reduction

Air saving by the energy saving SI unit and built-in pressure sensor  
(Under SMC's measurement conditions)

## Supply valve: N.O. specification available

- Can hold vacuum\*<sup>1</sup> even when the power goes out or is turned off
- Prevents the sudden dropping of workpieces\*<sup>1</sup>

\*<sup>1</sup> Supposing the supply pressure is being maintained

4 stations/8 stations/  
12 stations/16 stations  
manifold compatible

IP65  
Dust-tight/Water-jet-proof

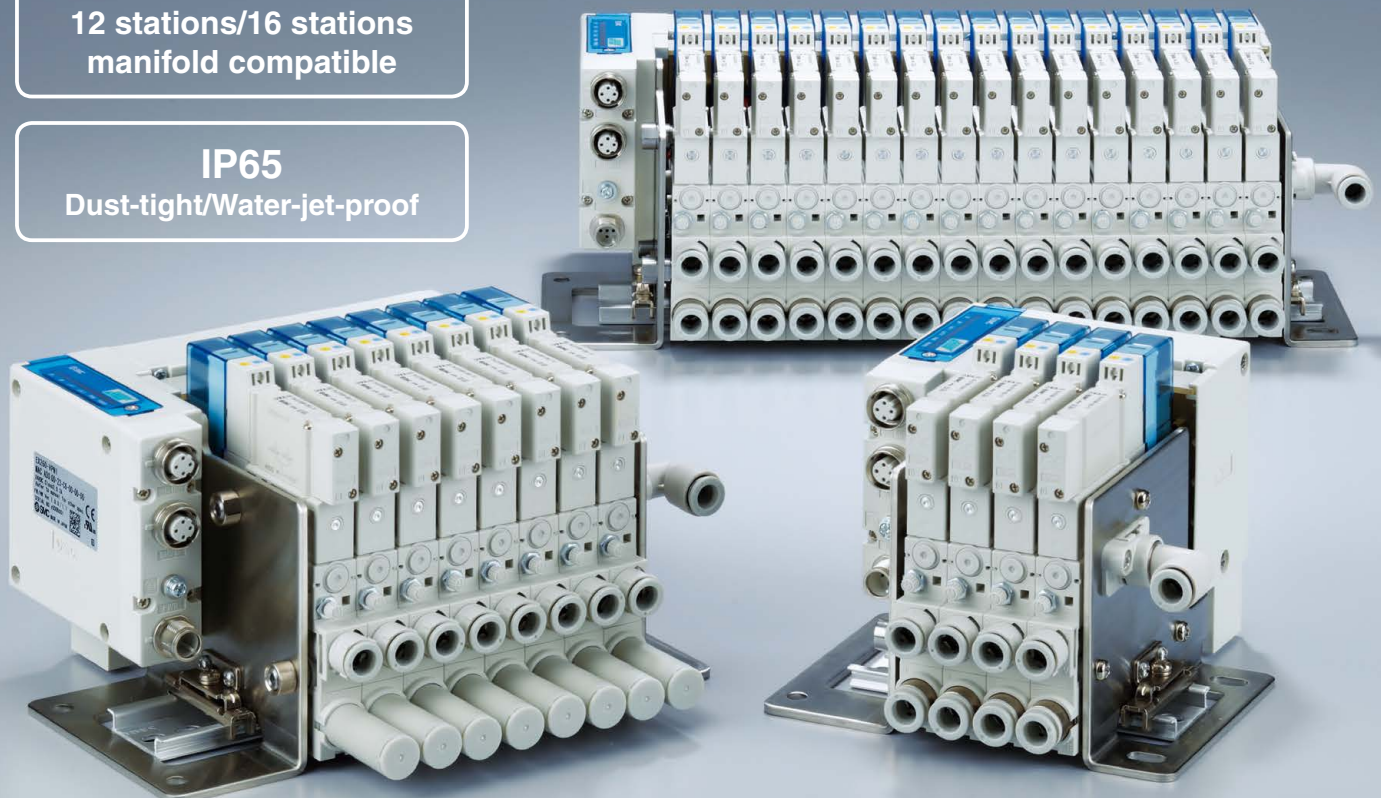

## ZKJ Series



CAT.ES100-140A®

## Energy saving

### Air saving by the energy saving SI unit and built-in pressure sensor

#### Air consumption

**90% reduction** \*1

\*1 Under SMC's measurement conditions

#### Energy saving function ON

Air is supplied **intermittently** when the vacuum decreases.

#### Energy saving function OFF

Air is supplied **continuously** during the adsorption of the workpiece.

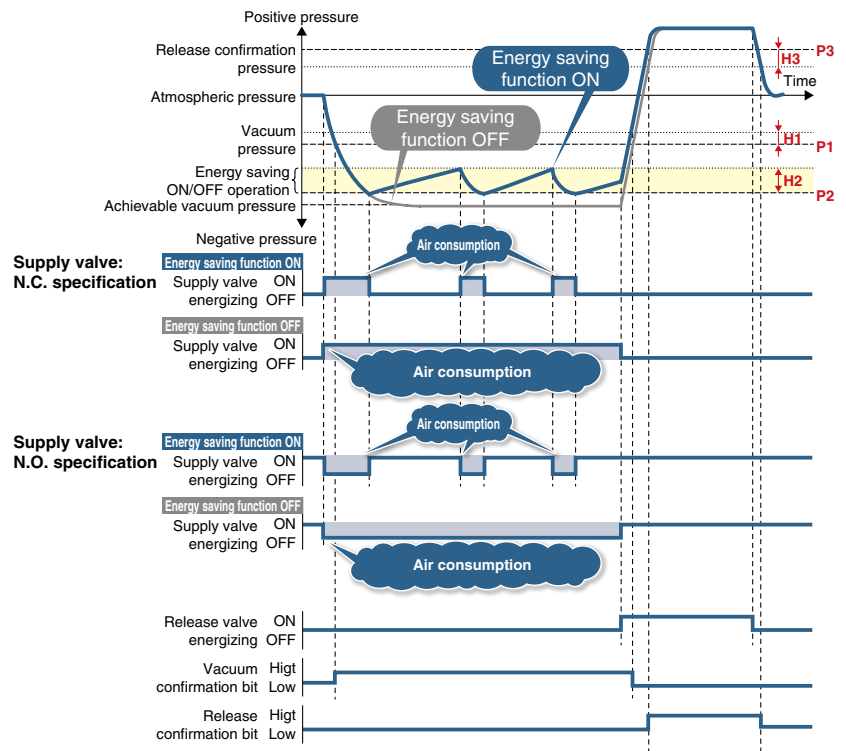

## Energy saving efficiency: 90% reduction

Power consumption cost per year reduced by **10,098 JPY/year**\*2

The energy saving function shortens the exhaust time, which reduces the annual power consumption cost.

Per ejector

	Power consumption cost per year	Annual air consumption	Air consumption (1 cycle)	Exhaust time (1 cycle)
ZKJ/Energy saving function ON	1,122 JPY/year	748 m <sup>3</sup> /year	0.68 L	<b>0.6 s</b>
ZKJ/Energy saving function OFF	11,220 JPY/year	7,480 m <sup>3</sup> /year	6.8 L	6 s

\*2 **Cost conditions** Air unit 1.5 JPY/m<sup>3</sup> (ANR), Annual operating cycles: 1100000 (Operating hours: 10 hours/day, Operating days: 250 days/year, 450 cycles, Vacuum ejector ZKJ12 (Air consumption 68 L/min (ANR)) when 1 unit is used)

### Supply valve (N.O.)

Vacuum can be held during a power outage or when the power is turned OFF, preventing the workpiece from dropping.\*1

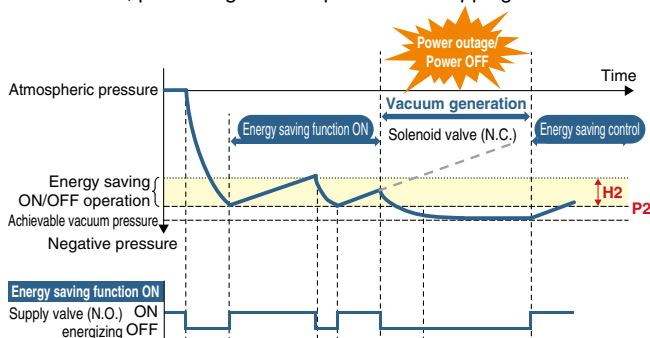

\*1 Supposing the supply pressure is being maintained

### Valve protection

If the supply valve reaches the set number of operations while the energy-saving function is in use, the energy-saving function turns OFF and switches to continuous adsorption to prevent excessive valve operation.

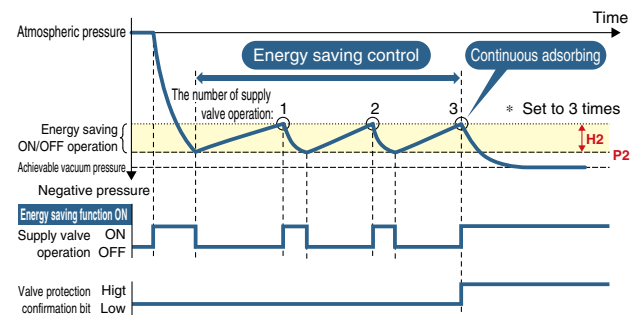

**Space saving/Less wiring work**

**Vacuum manifold for fieldbus system/For ZKJ**

- Can be connected directly to the PLC via Fieldbus without the need for a commercially available input/output unit
- Less communication/power supply cables and wiring work
- Reduced network load due to the reduction in the number of connected devices
- Simple wiring/Minimized disconnection risk

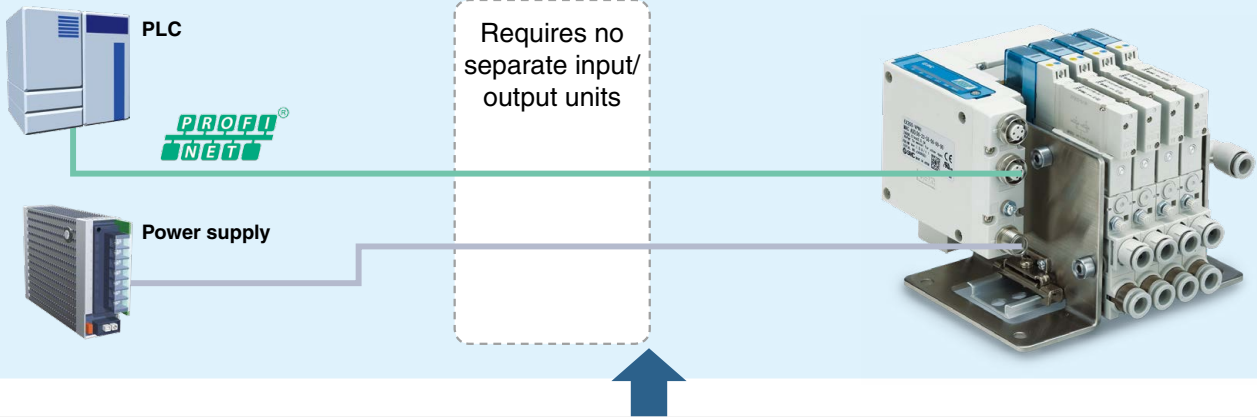

**Vacuum unit/For ZK2**

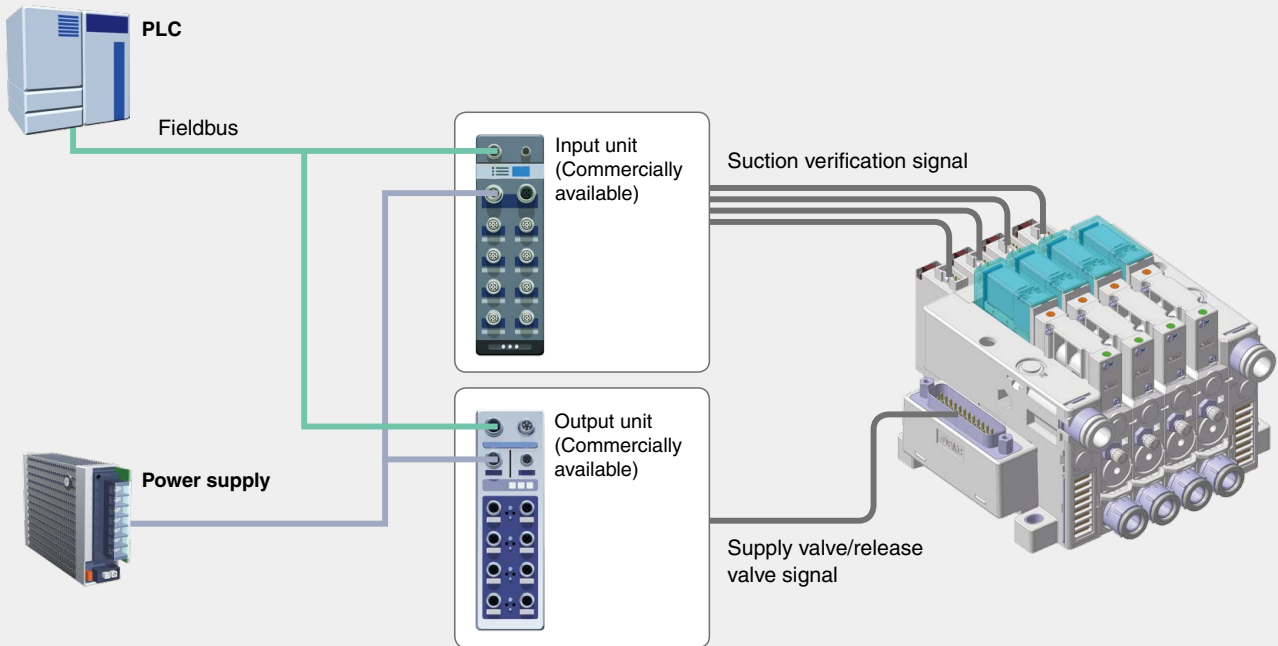

**Remote control and monitoring are available.**



**Configurable items**

- Energy saving function
- Pressure (checking adsorption (P1, H1), energy saving function threshold (P2, H2), release confirmation (P3, H3))

**Monitoring**

- Monitoring pressure of individual ejectors

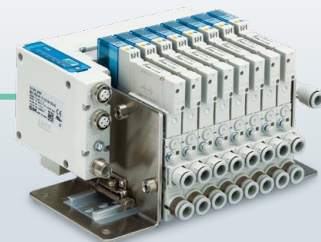

# PROFINET Compatible

## MRP/MRPD function

### MRP (Media Redundancy Protocol) function

Communication can be continued even if one of the communication cables in the network is disconnected or damaged. Furthermore, as it is possible to identify the disconnection point quickly, the network disconnection time can be kept within 200 ms.

\* In order to use the MRP function, the PLC must be able to support it.

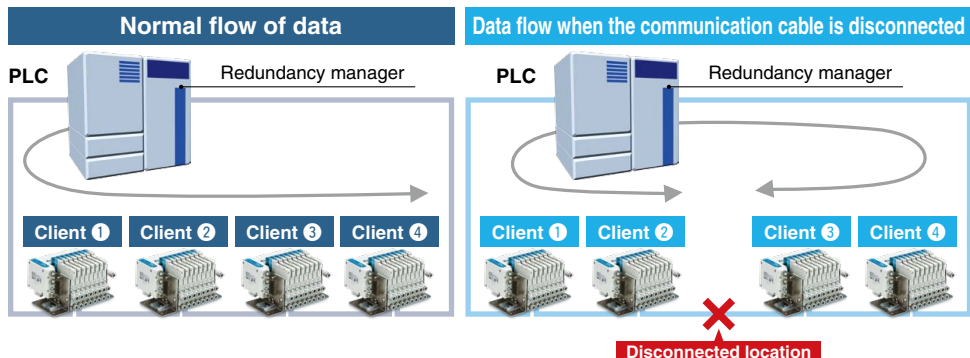

### MRPD (Media Redundancy for planned duplication)

It is possible to duplicate routes with a ring topology configured with PROFINET IRT communication.

Communication reconnection time is faster than with the MRP function, so communication can be continued without recovery time.

## Fast Start Up function

Time from power ON to communication connection:

Approx. 10 s

**0.5 s or less**  
for the Fast Start Up function

In the case of a tool changer, it takes about 10 seconds for communication to be connected in some products after the power to the device installed on the tool is turned ON. For products which support the Fast Start Up function, communication can be operational even faster.

\* In order to use the Fast Start Up function, the PLC must be able to support it.

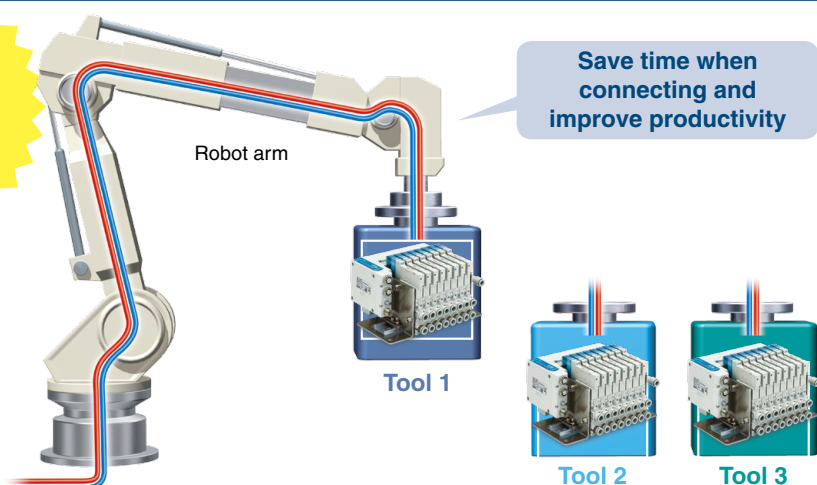

## FW (firmware) updates

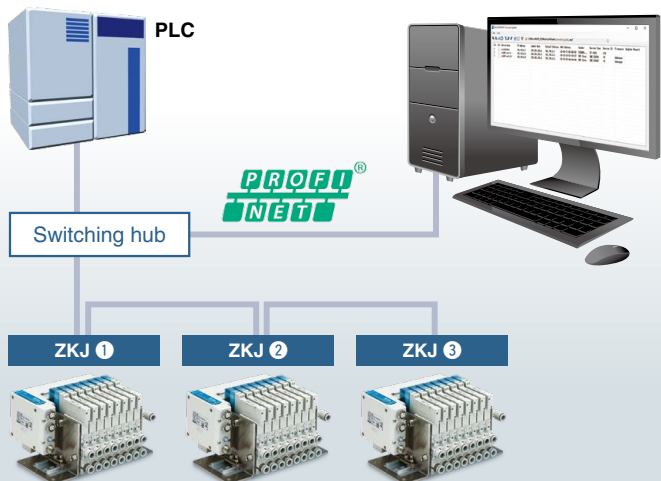

Connection example

No.	Sel	Device Name	IP Address	Subnet Mask	Default Gateway	MAC Address	Vendor	Device Type	Device ID	Firmware	Update Result
1	<input type="checkbox"/>	plc01-d01d	192.168.0.1	255.255.255.0	192.168.0.1	AD-64-17-6E-5B-80	SIEMENS	37-1000		276	
2	<input type="checkbox"/>	ec000-von1-4	192.168.0.2	255.255.255.0	192.168.0.2	88-29-08-51-01-07	SMC Corp.	SMC EX000	18	Unknown	
3	<input type="checkbox"/>	ec000-von1-16	192.168.0.3	255.255.255.0	192.168.0.3	88-29-08-AA-AA-AA	SMC Corp.	SMC EX000	18	Unknown	

- Batch firmware updating for up to 255 units is possible from the Ethernet line.
  - Easy to handle future version upgrades
- \* Depending on the product's hardware and firmware versions, it may not be possible to use the firmware update function.

**PROFINET Compatible** 

**Shared Device function**

An I/O data connected to an SI unit can be controlled and checked by multiple I/O controllers (PLC).

Ex. PLC1 controls the valve  
 PLC2 checks pressures or diagnostic data

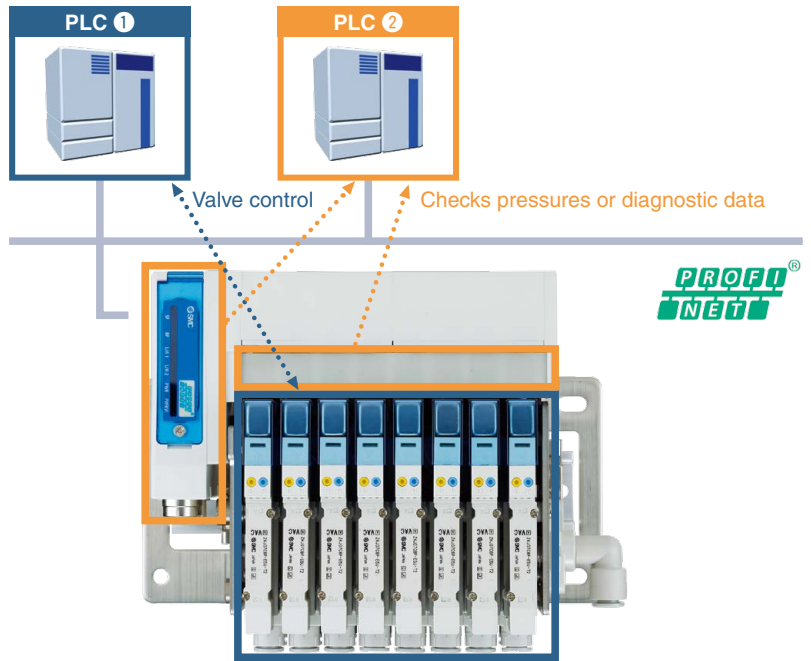

- Information can be shared with up to 3 controllers in addition to the control PLC.
- The cost of the hardware, cables, and installation space can be reduced.

Ex. Information of PLC4 is shared and monitored by PLC1 to 3.  
 PLC4 controls the valves and checks pressures.

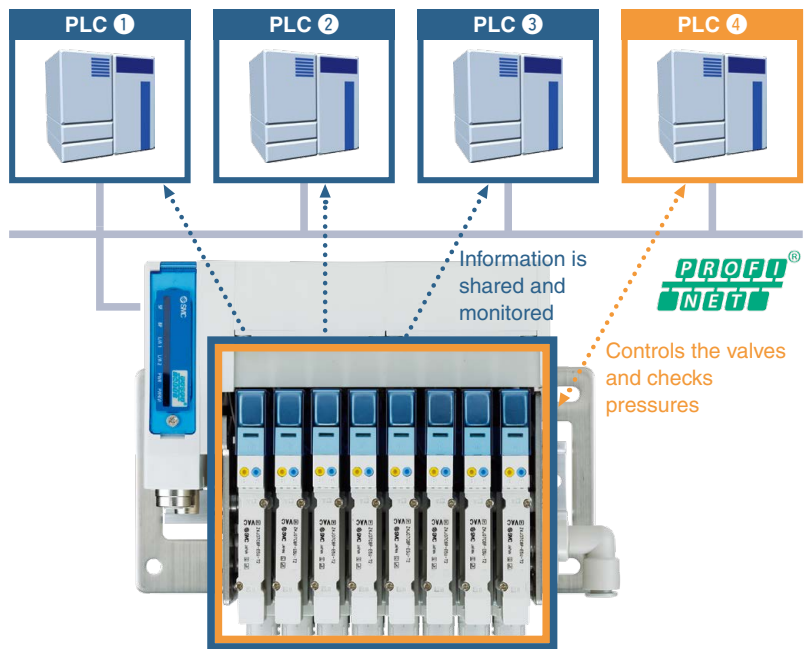

\* The Shared Device function enables an I/O module connected to the I/O device to be controlled by multiple I/O controllers (PLC). The control status can be shared among other I/O controllers. As the function can be used across the entire PROFINET line, the cost for hardware, cables, and installation space can be reduced.

**New IO-Link Compatible**  **IO-Link**

**Space saving/Less wiring work**

- Requires no separate input/output units
- Connectable to various networks via an IO-Link master  
(Communication is possible without reliance on a Fieldbus or PLC.)
- Less communication/power supply cables and wiring work
- Reduced wiring space
- Reduced network load due to the reduction in the number of Fieldbus connected devices
- Simple wiring/Minimized disconnection risk

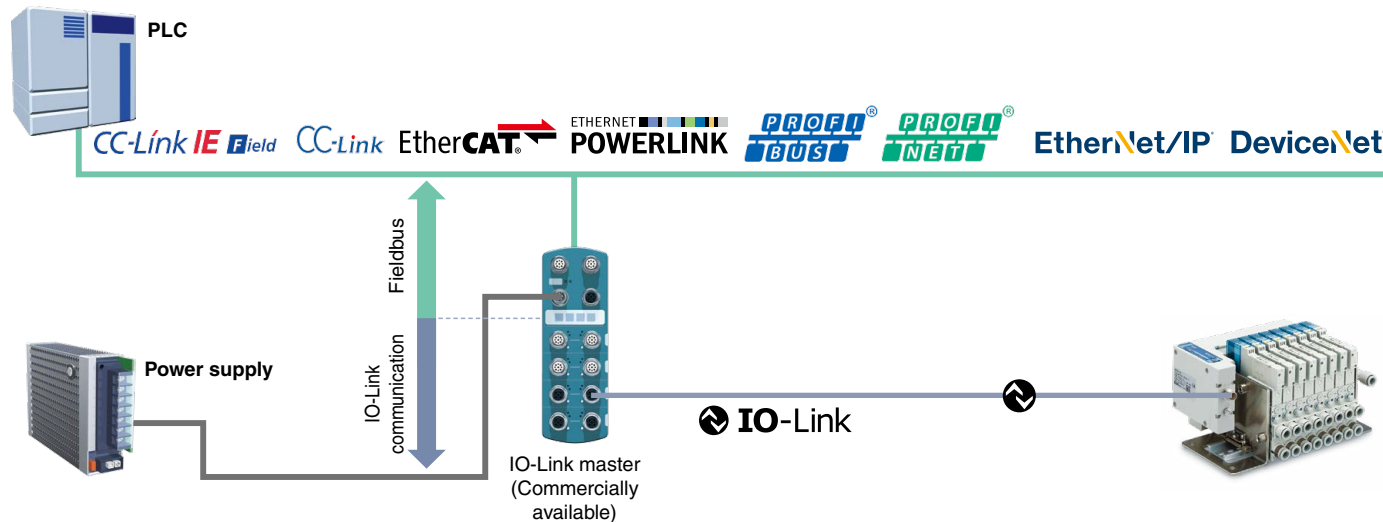

**Connectable with a single general-purpose cable**

**Port class B**

IO-Link master (Commercially available)

- Connect the IO-Link master port to the device using a 1:1 configuration.
- Connect using an M12 connector.
- Maximum cable length: 20 m
- Special communication cables are not necessary.  
\* In order to connect the SI unit using a single cable, use a port class B type IO-Link master.



Port class B compliant

Power supply load

**Port class A**

IO-Link master (Commercially available)

General-purpose 5-wire unshielded cables are used for connection. The signal wire and valve power supply wire can be connected with the same cable.

**SI unit/Connector pin arrangement**

Pin no.	SI unit port pin function (Port class B)
1	+24 V for control and input
2	+24 V for output
3	0 V for control and input
4	IO-Link communication
5	0 V for output

Power supply load

**Y Branch Connector**

**Port class A compliant**  
A special wiring Y branch connector is available.



Used when connecting to a port class A type IO-Link master, which is often used when connecting to an IO-Link sensor

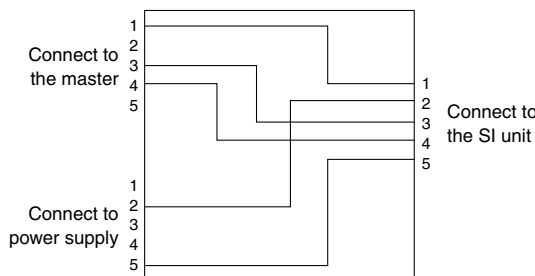

**Difference between IO-Link master port class A and class B**

Pin no.	IO-Link master port pin function	
	Port class A	Port class B
1	+24 V	+24 V
2	NC/DI/DO	Additional power supply +24 V
3	0 V	0 V
4	IO-Link/DI/DO	IO-Link/DI/DO
5	NC	Additional power supply 0 V

**New IO-Link Compatible**  **IO-Link**

## Self-diagnosis function/Automatic parameter saving and writing

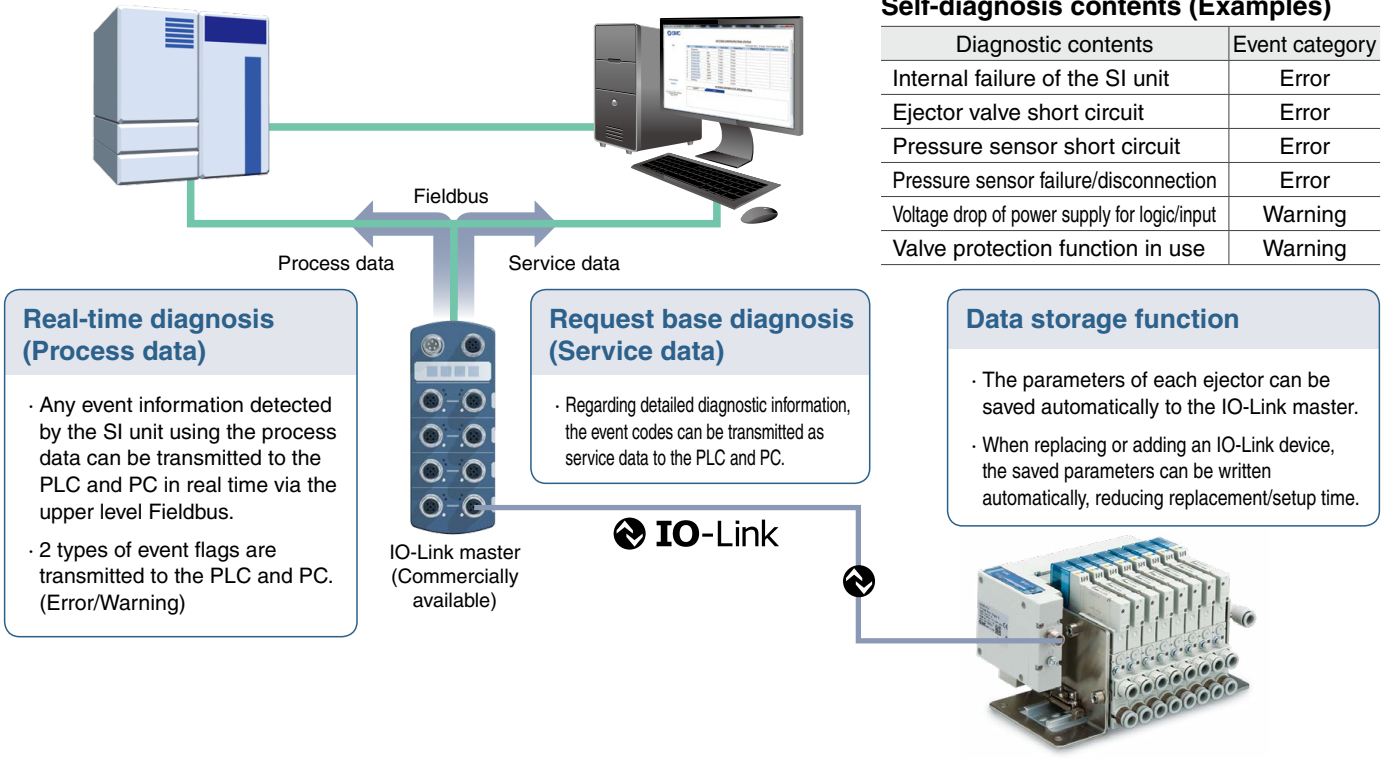

**Self-diagnosis contents (Examples)**

Diagnostic contents	Event category
Internal failure of the SI unit	Error
Ejector valve short circuit	Error
Pressure sensor short circuit	Error
Pressure sensor failure/disconnection	Error
Voltage drop of power supply for logic/input	Warning
Valve protection function in use	Warning

**Implement diagnostic bits in the process data.**  
 The diagnostic bit in the cyclic process data makes it easy to find problems with the equipment. It is possible to find problems with the equipment in real time using the cyclic (periodic) data and to monitor such problems in detail with the noncyclic (aperiodic) data.

**Process Data**

Vacuum manifold stations	Input process data	Output process data
4	4 byte	2 byte
8	5 byte	3 byte
12	6 byte	4 byte
16	7 byte	5 byte

\* The process data size occupied by the SI Unit depends on the number of vacuum manifold stations.

**Input process data**

Byte	1								0							
Bit offset	15	14	13	12	11	10	9	8	7	6	5	4	3	2	1	0
Item	Process data															
Byte	3								2							
Bit offset	31	30	29	28	27	26	25	24	23	22	21	20	19	18	17	16
Item	CH3 Release confirmation	CH3 Suction verification	CH2 Release confirmation	CH2 Suction verification	CH1 Release confirmation	CH1 Suction verification	CH0 Release confirmation	CH0 Suction verification	Valve protection	Parameter setting error	Supply valve setting mismatch	Power supply diagnostics for logic/input	Manifold connection error	Pressure sensor failure/disconnection	Pressure sensor short circuit	Valve short circuit
Byte	5								4							
Bit offset	47	46	45	44	43	42	41	40	39	38	37	36	35	34	33	32
Item	CH11 Release confirmation	CH11 Suction verification	CH10 Release confirmation	CH10 Suction verification	CH9 Release confirmation	CH9 Suction verification	CH8 Release confirmation	CH8 Suction verification	CH7 Release confirmation	CH7 Suction verification	CH6 Release confirmation	CH6 Suction verification	CH5 Release confirmation	CH5 Suction verification	CH4 Release confirmation	CH4 Suction verification
Byte	6															
Bit offset																
Item	CH15 Release confirmation	CH15 Suction verification	CH14 Release confirmation	CH14 Suction verification	CH13 Release confirmation	CH13 Suction verification	CH12 Release confirmation	CH12 Suction verification								

\* The pressure value of the monitoring channel selected in the output process data can be checked.

**Output process data**

Byte	1								0							
Bit offset	15	14	13	12	11	10	9	8	7	6	5	4	3	2	1	0
Item	CH3 Release instruction	CH3 Vacuum instruction	CH2 Release instruction	CH2 Vacuum instruction	CH1 Release instruction	CH1 Vacuum instruction	CH0 Release instruction	CH0 Vacuum instruction	Pressure value monitoring channel selection							
Byte	3								2							
Bit offset	31	30	29	28	27	26	25	24	23	22	21	20	19	18	17	16
Item	CH11 Release instruction	CH11 Vacuum instruction	CH10 Release instruction	CH10 Vacuum instruction	CH9 Release instruction	CH9 Vacuum instruction	CH8 Release instruction	CH8 Vacuum instruction	CH7 Release instruction	CH7 Vacuum instruction	CH6 Release instruction	CH6 Vacuum instruction	CH5 Release instruction	CH5 Vacuum instruction	CH4 Release instruction	CH4 Vacuum instruction
Byte	4															
Bit offset																
Item	CH15 Release instruction	CH15 Vacuum instruction	CH14 Release instruction	CH14 Vacuum instruction	CH13 Release instruction	CH13 Vacuum instruction	CH12 Release instruction	CH12 Vacuum instruction								

## Variations

### SI unit/Compatible protocol

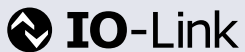

### Manifold stations

4 stations, 8 stations,  
12 stations, 16 stations

### Nozzle size

ø0.7, ø1.0, ø1.2, ø1.5

### Combination of supply valve and release valve

Supply valve	Release valve
N.O.	N.C.
N.C.	N.C.

### Manual override for residual pressure release

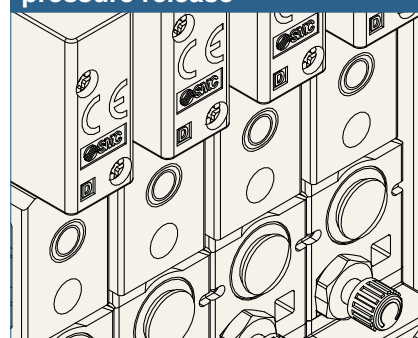

None (Plug)

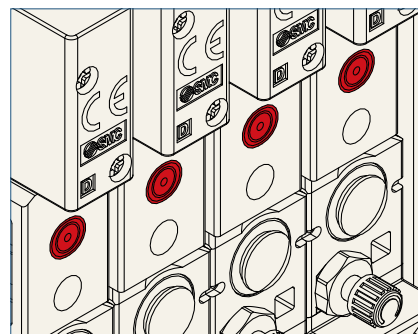

Red manual override\*1  
\*1 Option

### Air pressure supply (P) port

ø8, ø5/16" One-touch fittings

### Air pressure supply (P) port

None (Plug)/ø6, ø1/4" One-touch fittings

### Vacuum (V) port

ø6, ø8 One-touch fittings  
ø1/4", ø5/16" One-touch fittings

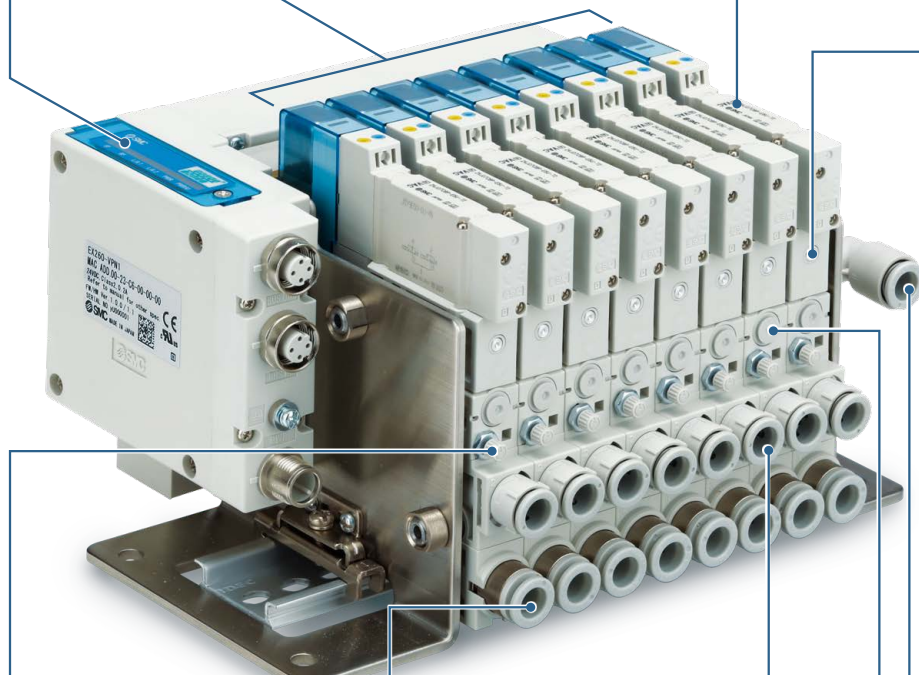

### Vacuum break flow adjusting needle

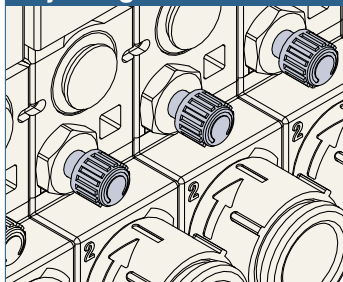

Manual override type

### Exhaust (EXH) port

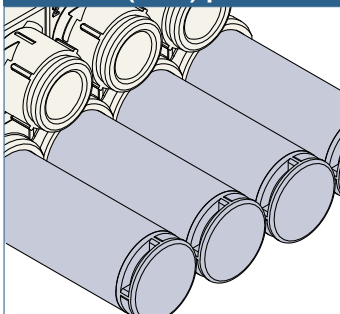

High-noise reduction silencer exhaust

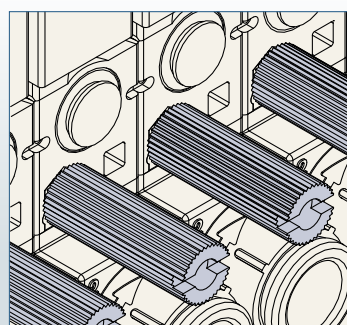

Screwdriver operation type long lock nut\*2

\*2 Option

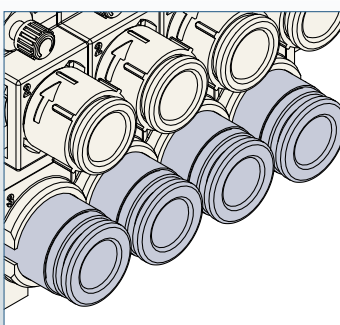

Port exhaust



**No tools are required!  
Maintenance labor can be reduced.**

**Easier replacement of the filter element  
Vacuum port located above the exhaust port**

\* The location of the vacuum port and exhaust port is different from ZK2 series.

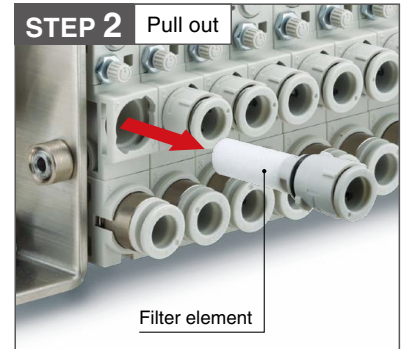
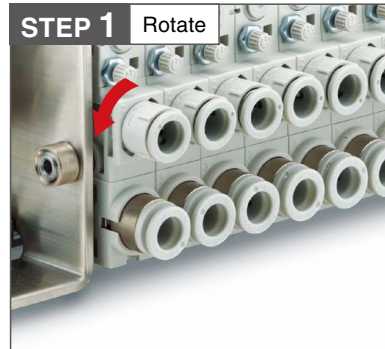
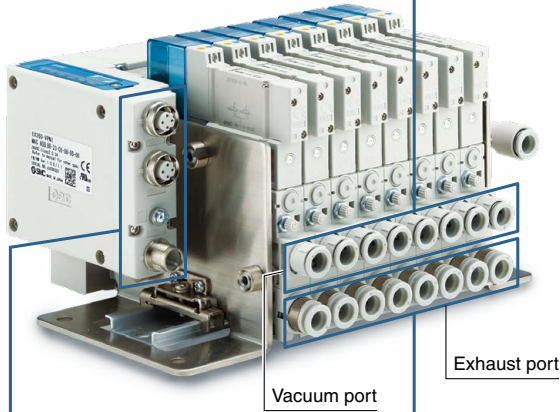

**Applicable for the high performance silencer exhaust**

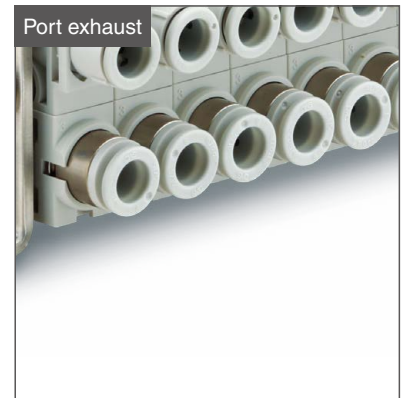
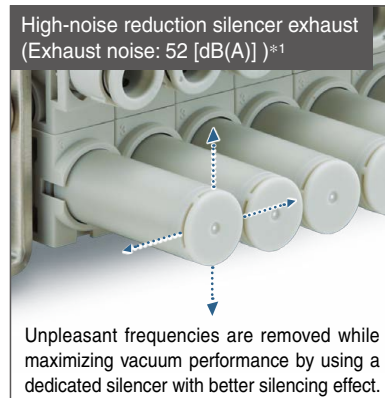

\*1 Adsorbs the workpiece (nozzle diameter  $\phi 0.7$  (1 station)). (Under SMC's measurement conditions)

**Wiring and piping are integrated on one side.**

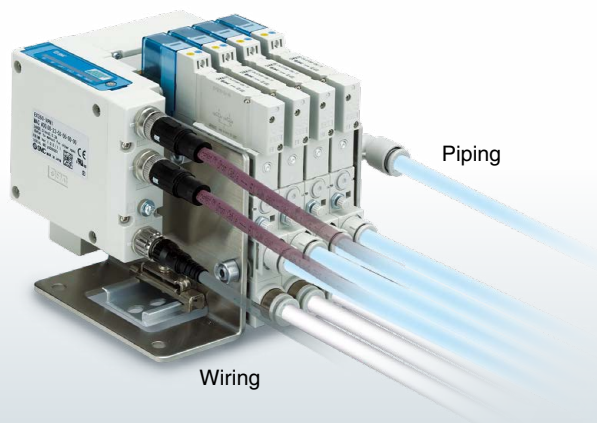



# CONTENTS

## Vacuum Manifold for Fieldbus System *ZKJ Series*

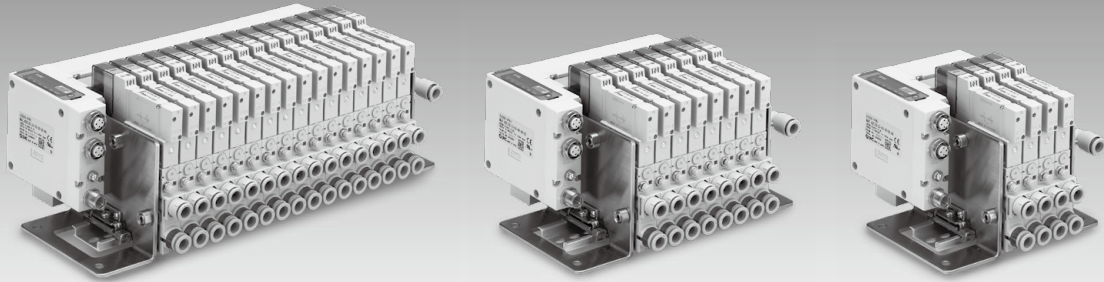

How to Order .....	p. 9
Specifications .....	p. 11
Exhaust Characteristics/Flow Rate Characteristics .....	p. 13
Vacuum Release Flow Rate Characteristics, How to Read the Flow Rate Characteristics Graph .....	p. 15
Dimensions .....	p. 16
Air Circuit Diagram, Construction .....	p. 17
How to Order Replacement Parts .....	p. 18
Exploded View of Manifold .....	p. 19
How to Increase Manifold Stations .....	p. 20
Manifold Options .....	p. 21
Accessories .....	p. 22
Specific Product Precautions .....	p. 26

# Vacuum Manifold for Fieldbus System

## ZKJ Series



This product cannot be ordered only with the manifold part number. Under the manifold part number, be sure to add the single unit part number with an asterisk prefix.

### How to Order

Vacuum manifold **ZZKJ 04 - FAN - L8**

①                      ②                      ③

#### ① Manifold stations

Symbol	Manifold stations	Vacuum ejector stations
<b>04</b>	4	Max. 4 stations
<b>08</b>	8	Max. 8 stations
<b>12</b>	12	Max. 12 stations
<b>16</b>	16	Max. 16 stations

- \* The product outline is every four stations manifold. Be sure that the total number of the ejectors and the blanking plates is equal to the manifold stations.
- \* The manifold model number cannot be ordered alone.
- \* The ejector can be increased by exchanging the blanking plate to an ejector, and also decreased for maintenance. Refer to How to Increase Manifold Stations on page 20.

#### ② SI Unit Specifications

Symbol	Protocol
<b>FAN</b>	PROFINET
<b>KAN</b>	IO-Link

#### ③ U-side end plate and supply (P) port

Symbol	Supply (P) port
<b>L8</b>	ø8 Elbow One-touch fittings
<b>LN9</b>	ø5/16" Elbow One-touch fittings



This product cannot be ordered only with the manifold part number. Under the manifold part number, be sure to add the single unit part number with an asterisk prefix.

### Ordering Example

#### Example 1

- When the number of vacuum ejector stations is 6, select 8 stations for a manifold and order 2 sets of blanking plates.

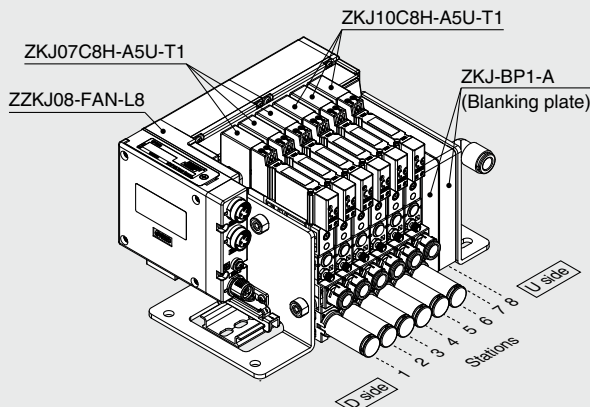

- ZKJ08-FAN-L8 ..... 1 set (Manifold part number)
- \* ZKJ07C8H-A5U-T1 ..... 3 sets
- \* ZKJ10C8H-A5U-T1 ..... 3 sets
- \* ZKJ-BP1-A ..... 2 sets

↳ The asterisk denotes the symbol for the assembly. Prefix to the single unit part number.

#### Example 2

- When the number of vacuum ejector stations is 8 and it is possible that the stations increase to 12, select 12 stations for a manifold and order 4 sets of blanking plates.

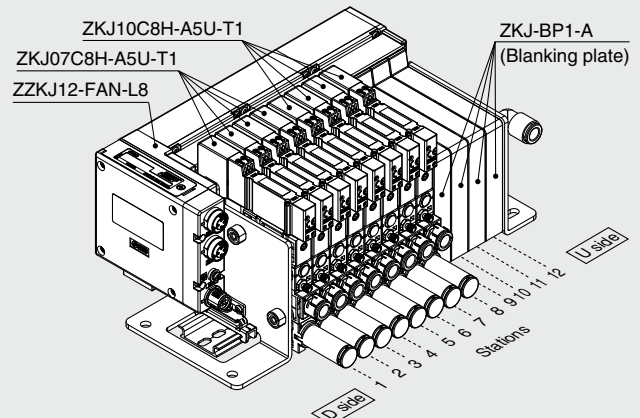

- ZKJ12-FAN-L8 ..... 1 set (Manifold part number)
- \* ZKJ07C8H-A5U-T1 ..... 4 sets
- \* ZKJ10C8H-A5U-T1 ..... 4 sets
- \* ZKJ-BP1-A ..... 4 sets

↳ The asterisk denotes the symbol for the assembly. Prefix to the single unit part number.

- When the manifold is viewed from V port, the first station starts from the left (D side).
- After the manifold part number, specify the installed single unit from the first station.
- Please refer to Manifold Options on page 21 for details of the blanking plate.

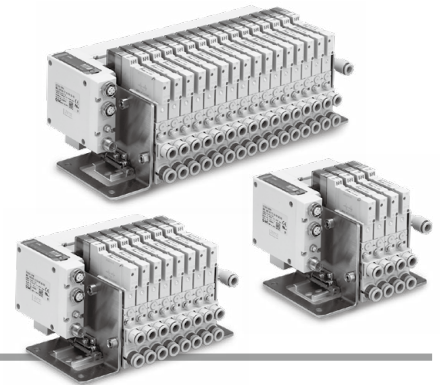

**⚠ Caution** This product cannot be ordered only with the manifold part number. Under the manifold part number, be sure to add the single unit part number with an asterisk prefix.

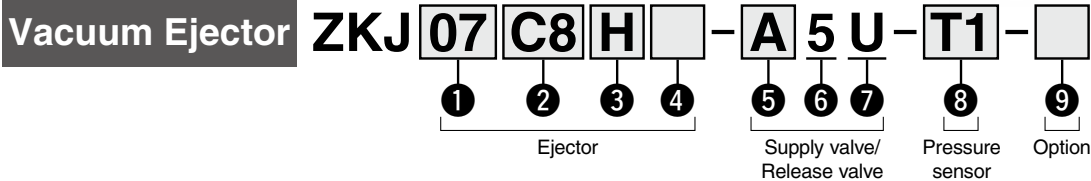

### ① Nominal nozzle size

Symbol	Nominal nozzle size
<b>07</b>	ø0.7
<b>10</b>	ø1.0
<b>12</b>	ø1.2
<b>15</b>	ø1.5

### ② Vacuum (V) port, supply (P) port

Symbol	Standard	Vacuum (V) port	Supply (P) port
<b>C6</b>	Metric	ø6	Plug
<b>C8</b>		ø8	
<b>N7</b>	Inch	ø1/4"	
<b>N9</b>		ø5/16"	
<b>C6U</b>	Metric	ø6	ø6*1
<b>C8U</b>		ø8	
<b>N7U</b>	Inch	ø1/4"	ø1/4"*1
<b>N9U</b>		ø5/16"	

\*1 When selecting "Plug for individual supply" for options (8) or increasing the flow rate of supply air, select Supply (P) port.

### ③ Exhaust (EXH) port

Symbol	Exhaust
<b>H</b>	High-noise reduction silencer exhaust
<b>P</b>	Port exhaust*2

\*2 Port size of exhaust port; mm: ø8, inch: ø5/16"

### ④ Exhaust sealing valve

Symbol	Specification
<b>Nil</b>	None
<b>V</b>	Exhaust sealing valve

\* When "15" is selected for the nominal nozzle size, leave the symbol for the exhaust sealing valve blank.

### ⑤ Combination of supply valve and release valve

Symbol	Supply valve	Release valve
<b>A</b>	N.C.	N.C.
<b>E</b>	N.O.	N.C.

### ⑥ Rated voltage

Symbol	Voltage
<b>5</b>	24 VDC

### ⑦ Light/surge voltage suppressor and common specification

Symbol	With light	Surge voltage suppressor	Common specification
<b>U</b>	Yes	Yes	Non-polar

### ⑧ Pressure sensor

Symbol	Specifications
<b>T1</b>	-100 to 100 [kPa]
<b>T2</b>	-100 to 200 [kPa]

\* When "Nil" for ④ exhaust sealing valve is selected, T1 is available, when "V" is selected, T2 is available.

Change the SI unit settings in accordance with the specifications of the selected pressure sensor.

### ⑨ Option\*3

Symbol	Type
<b>Nil</b>	Without option
<b>E</b>	Vacuum break flow adjusting needle screwdriver operation type long lock nut
<b>M</b>	Plug for individual supply*4, *5 (Blocking the air supply passage to the D side)
<b>R</b>	With manual override for residual pressure release*6
<b>Y</b>	Vacuum (V) port release to atmosphere type (Check valve: 1 pc.)*7

\*3 When more than one option is selected, list the option symbols in alphabetical order. (Example -EM)

\*4 The supply (P) port for vacuum manifold is mounted only on the U side.

Select the supply (P) port for ② on the D side of the ejector where the plug for individual supply is mounted. For detail, refer to Manifold Option on page 21.

\*5 The plug for individual supply is mounted on the first station to block the air supply passage to the D side. Option M can be selected after second station.

\*6 Manual override to release vacuum (V) port to atmosphere. When option R is selected, option Y cannot be used together.

\*7 When "Y" is selected, the energy saving function is not available. When the vacuum generation is stopped, the vacuum (V) port is released to the atmosphere.

\*8 When option Y is selected, "V" for ④ exhaust sealing valve cannot be selected.

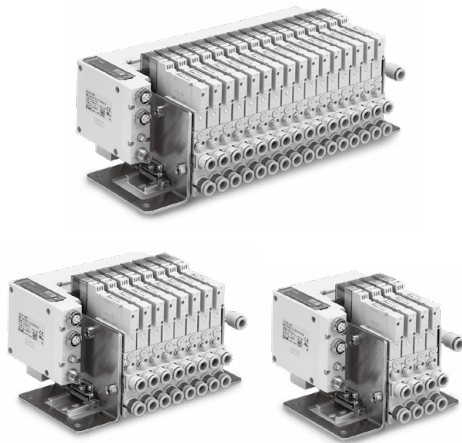

\* The solenoid valve mounted on this product is equivalent to the SMC JSY3000 series 5-port solenoid valve.

For details on solenoid valve functions, refer to the Operation Manual of the JSY3000 series on the SMC website (<https://www.smcworld.com>).

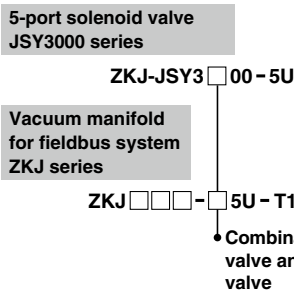

## Specifications

### Ejector\*1

Model		ZKJ07	ZKJ10	ZKJ12	ZKJ15	
Fluid		Air				
Nozzle size [mm]		0.7	1.0	1.2	1.5	
Standard supply pressure [MPa]		0.4				
Max. vacuum pressure [kPa]*2		-89				
Max. suction flow rate [L/min (ANR)]*2, *3	Port exhaust	Without exhaust sealing valve	31	53	63	74
		With exhaust sealing valve	30	48	57	—
	High-noise reduction silencer exhaust	Without exhaust sealing valve	31	51	60	68
		With exhaust sealing valve	30	45	54	—
Air consumption [L/min (ANR)]*2		26	48	68	102	
Supply pressure range [MPa]		0.3 to 0.5				
Type of actuation		Supply valve: N.C., Release valve: N.C. (ZKJ-JSY3A) Supply valve: N.O., Release valve: N.C. (ZKJ-JSY3E)				
Response time (at 0.5 MPa)*4		23 ms or less				
Max. operating frequency		3 Hz				
Manual override		Non-locking push type				
Power consumption		0.4 W				
Environmental resistance	Operating temperature range		0 to 50°C (No condensation)			
	Vibration resistance*5		30 m/s <sup>2</sup>			
	Impact resistance*6		150 m/s <sup>2</sup>			
	Withstand voltage		500 VAC for 1 minute between terminals and FE			
	Insulation resistance		500 VDC, 10 MΩ or more between terminals and FE			
Enclosure*7		IP65				
Standards		CE/UKCA marking (EMC directive/RoHS directive)				

\*1 The supply valve and release valve mounted on this product is the SMC dual 3-port valve JSY3000 series. Refer to the **Web Catalog** for details on the JSY3000 series.

\*2 Values are at the standard supply pressure and based on SMC's measurement standards. They depend on atmospheric pressure (weather, altitude, etc.) and the measurement method.

\*3 If the vacuum port diameter is  $\phi 6$  or  $\phi 1/4$ ", Max. Suction flow rate is reduced by 15% or less.

\*4 It shows supply valve/release valve specification. Based on dynamic performance test, JIS B 8419-2010. (Coil temperature: 20°C, at rated voltage)

\*5 The characteristics are satisfied when tested for 2 hours in each of the X, Y and Z directions at 10 to 500 Hz without energization. (Initial value)

\*6 The characteristics are satisfied when tested one time in each of the X, Y and Z directions without energization. (Initial value)

\*7 Cannot be used in an environment where oil such as cutting oil splashes or it is constantly exposed to water  
Take appropriate protective measures.

### Max. Number of Manifold Stations that Can Operate Simultaneously\*8

Model	ZKJ07	ZKJ10	ZKJ12	ZKJ15
Air supply: 1 section (U-side end plate P port ( $\phi 8$ ))	16	6	5	3
Air supply: 2 sections (U-side end plate P port ( $\phi 8$ ), Vacuum ejector P port ( $\phi 6$ ))	16	8	7	4

\*8 Values are the number of ejector stations that can be generated vacuum simultaneously.

### Noise Level (Reference values)

Model	ZKJ07	ZKJ10	ZKJ12	ZKJ15
Noise level [dB(A)]	52	63	67	71

\*9 Values are at the standard supply pressure.

\*10 Values are with 1 ejector generating vacuum pressure adequately for adsorption with high-noise reduction silencer (Not guaranteed values)

### Weight

Manifold stations (ejectors)	4 stations	8 stations	12 stations	16 stations
Weight [kg]	1.7	2.5	3.3	4.1

\*11 When the blanking plate is mounted, please subtract 0.1 [kg] per unit.

## Specifications

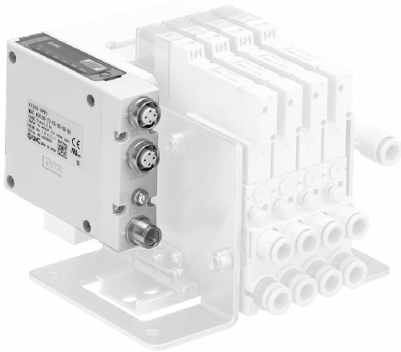

### SI Unit (PROFINET) (For details, refer to the Operation Manual.)

Model			EX260-VPN1
Electrical	Power supply for Control/ Input	Power supply voltage	24 VDC $\pm$ 10%
		Internal current consumption	100 mA or less
	Power supply for output	Power supply voltage	24 VDC +10%, -5%
Communication	Protocol		PROFINET
	Device type		PROFINET IO
	Configuration file*1		GSD File
	Version		PROFINET Specification Version 2.3
	Communication speed		100 Mbps full duplex
Vacuum	Applicable function		MRP function MRPD function Fast Start Up function Shared Device function FW update function Conformance Class C Net Load Class III
	Applicable function		Energy saving Valve protection Zero-clear function

\*1 The configuration file can be downloaded from the SMC website: <https://www.smcworld.com>

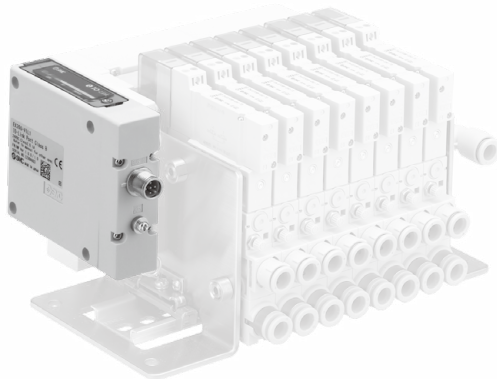

### SI Unit (IO-Link)

Model			EX260-VIL1
Electrical	Power supply for Control/ Input	Power supply voltage	24 VDC $\pm$ 10%
		Internal current consumption	100 mA or less
	Power supply for output	Power supply voltage	24 VDC +10%, -5%
Communication	Protocol		IO-Link
	IO-Link type		Device
	Port Class		Class B
	Configuration file*2		IODD File
	Version		V1.1
	Communication speed		COM2 (38.4 kbps)
Vacuum	Applicable function		ISDU Data Storage FW update function
	Applicable function		Energy saving Valve protection Zero-clear function

\*2 The configuration file can be downloaded from the SMC website: <https://www.smcworld.com>

### Control Unit Specifications

Model		ZKJ-S004-A	ZKJ-S008-A	ZKJ-S012-A	ZKJ-S016-A
Station		4	8	12	16
Input	Pressure sensor	4	8	12	16
	Pressure sensor short circuit detection/Protection circuit	Built-in (Common detection/protection)			
Output	Number of valve outputs	8	16	24	32
	Valve short circuit detection/Protection circuit	Built-in (Individual detection/protection)			

### Pressure Sensor Specifications

(For details, refer to the PSE54□ series in the **Web Catalog**, and the Operation Manual.)

Item		Specifications
Rated pressure range	Without exhaust sealing valve	-100 to 100 [kPa]
	With exhaust sealing valve	-100 to 200 [kPa]
Withstand pressure*3		500 [kPa]
Accuracy		$\pm$ 3% F.S.
Current consumption		15 mA or less
Sensor pressure receiving area		Silicon

\*3 Do not use the product to drive an actuator such as a cylinder (when release pressure is constantly applied).

# ZKJ Series

## Connector/LED Indicator

	Part no.	<b>EX260-VPN1</b>
	Protocol	<b>PROFINET</b>
	<b>Communication connector (M12) BUS OUT</b>	4-pin, Socket, D-coded (SPEEDCON)
	<b>Communication connector (M12) BUS IN</b>	4-pin, Socket, D-coded (SPEEDCON)
	<b>Ground terminal</b>	M3
	<b>Power supply connector (M12)</b>	4-pin, Plug, A-coded (SPEEDCON)

### EX260-VPN1

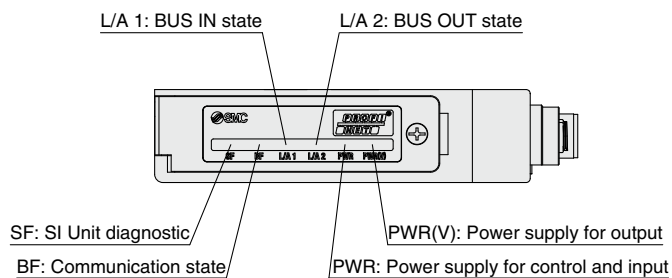

	Part no.	<b>EX260-VIL1</b>
	Protocol	<b>IO-Link</b>
	<b>Communication/Power connector (M12)*1</b>	5-pin, Plug, A-coded (SPEEDCON)
	<b>Ground terminal</b>	M3

\*1 The communication line, Power supply for control and input line, and the power supply for output line are connected using the same cable.

### EX260-VIL1

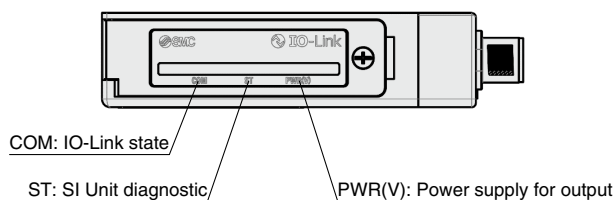





- \* Values are based on standard of SMC measurements. They depend on atmospheric pressure (weather, altitude, etc.) and measurement method.
- \* The flow rate characteristics correspond to the standard supply pressure.

## Exhaust Characteristics/Flow Rate Characteristics (Representative value)

### ZKJ07

#### Exhaust Characteristics

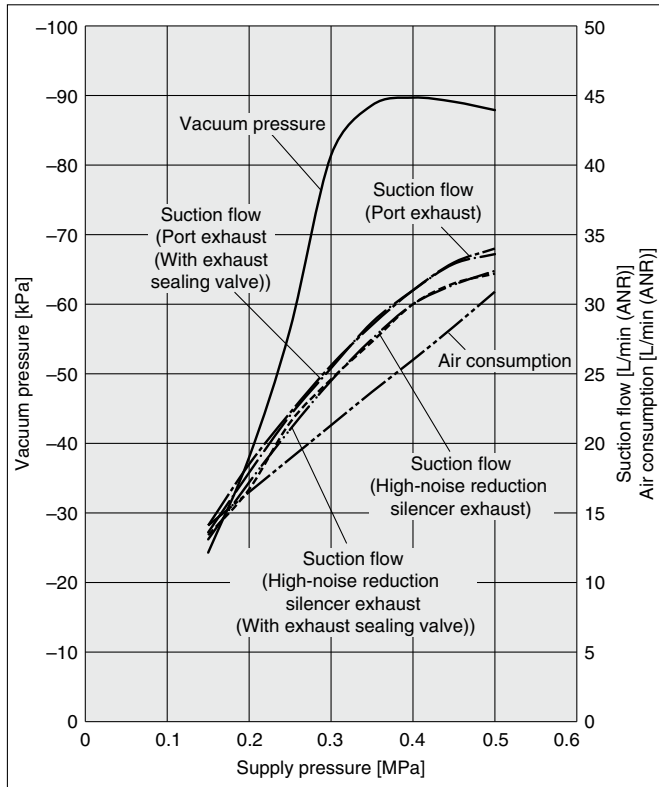

#### Flow Rate Characteristics

Supply pressure: 0.4 MPa  
(Standard supply pressure)

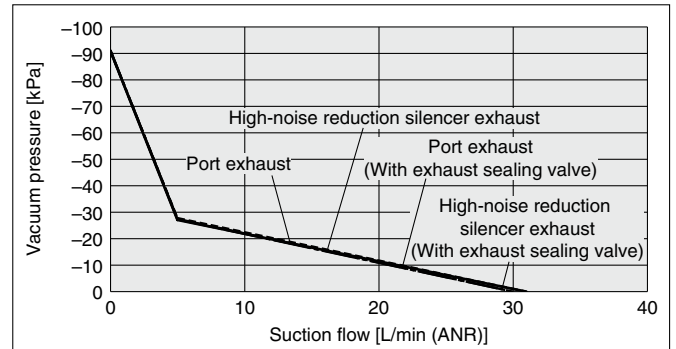

\* Port exhaust: V port ø8, no exhaust port piping

### ZKJ10

#### Exhaust Characteristics

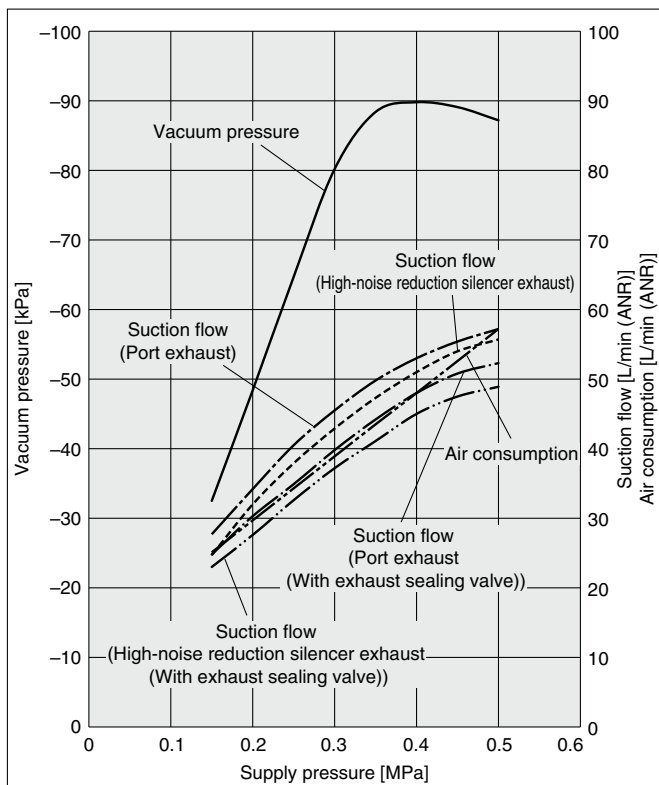

#### Flow Rate Characteristics

Supply pressure: 0.4 MPa  
(Standard supply pressure)

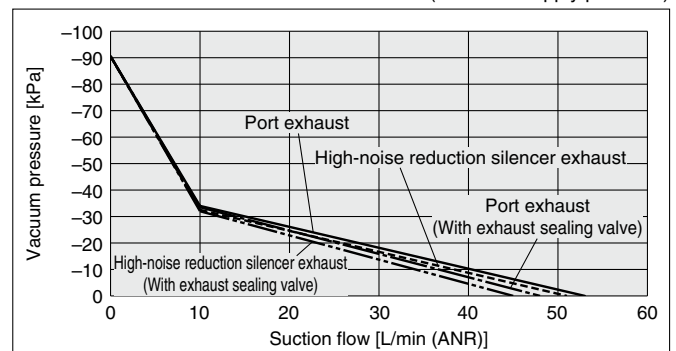

\* Port exhaust: V port ø8, no exhaust port piping

\* Values are based on standard of SMC measurements. They depend on atmospheric pressure (weather, altitude, etc.) and measurement method.  
 \* The flow rate characteristics correspond to the standard supply pressure.

## Exhaust Characteristics/Flow Rate Characteristics (Representative value)

### ZKJ12

#### Exhaust Characteristics

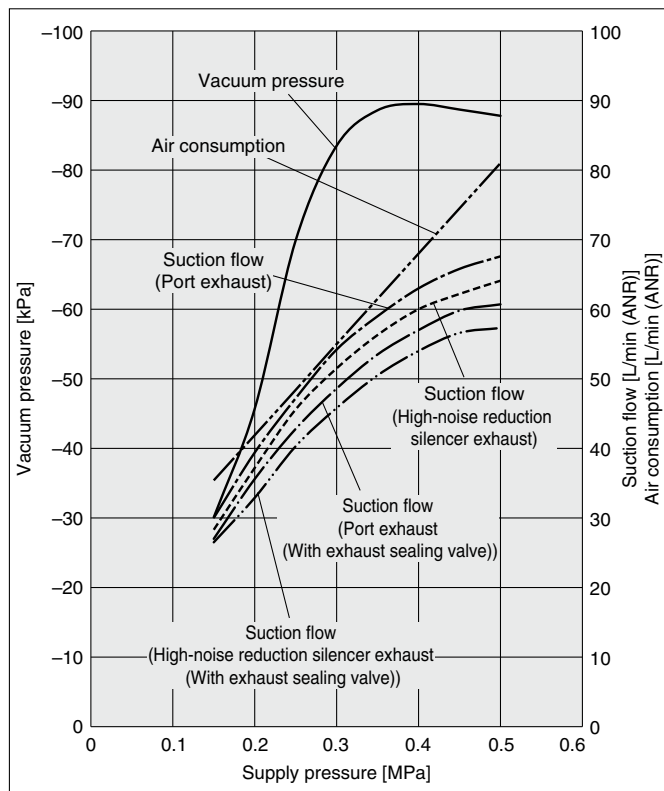

#### Flow Rate Characteristics

Supply pressure: 0.4 MPa  
(Standard supply pressure)

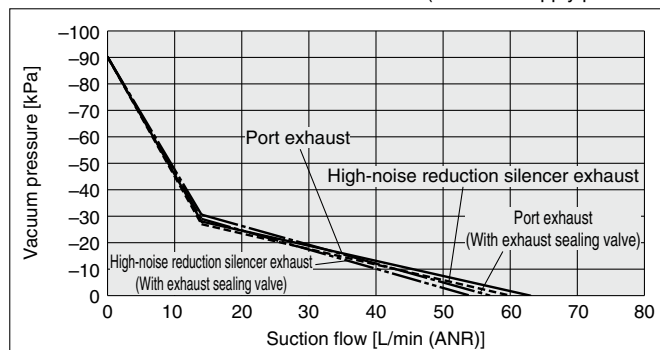

\* Port exhaust: V port ø8, no exhaust port piping

### ZKJ15

#### Exhaust Characteristics

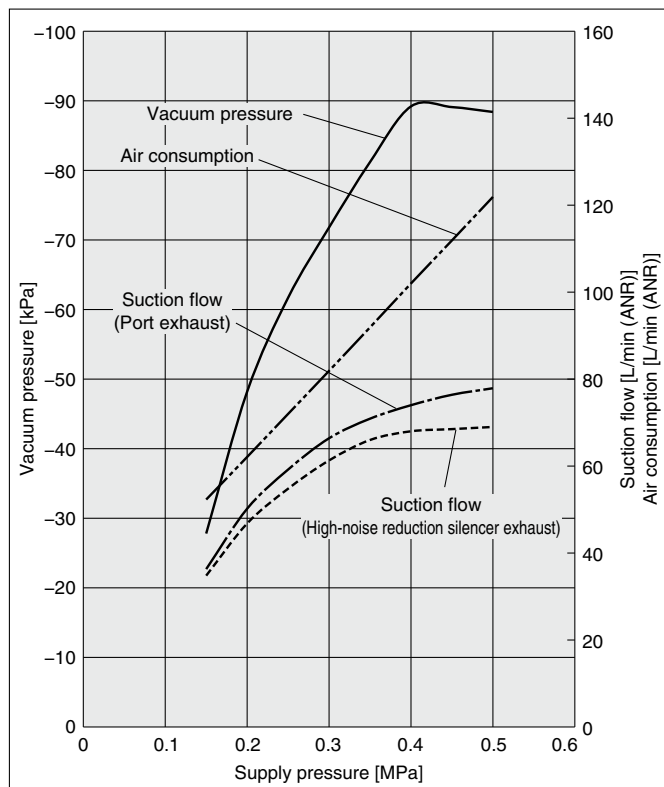

#### Flow Rate Characteristics

Supply pressure: 0.4 MPa  
(Standard supply pressure)

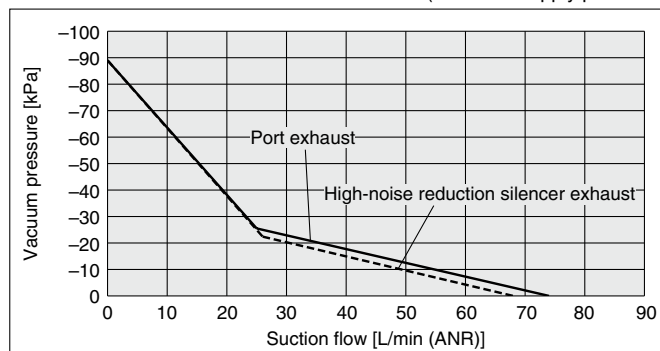

\* Port exhaust: V port ø8, no exhaust port piping

## Vacuum Release Flow Rate Characteristics (Representative value)

The graph shows the flow rate characteristics at different supply pressures when the vacuum break flow adjusting needle is open from the fully closed state. The actual suction flow at the point of suction varies depending on the piping conditions.

### Without exhaust sealing valve/Nozzle size: $\phi 0.7$

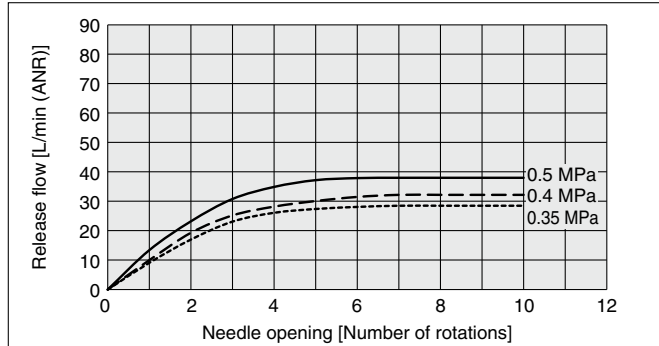

### With exhaust sealing valve/Nozzle size: $\phi 0.7$

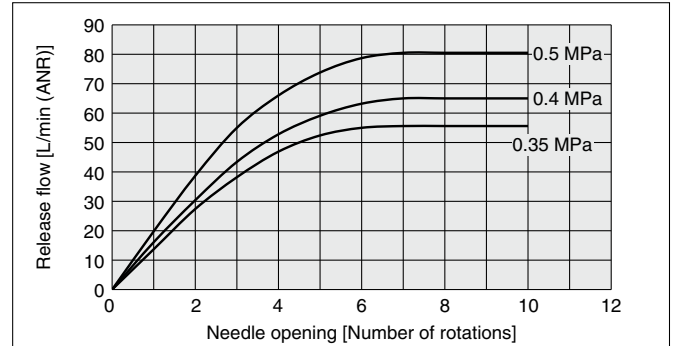

## How to Read the Flow Rate Characteristics Graph

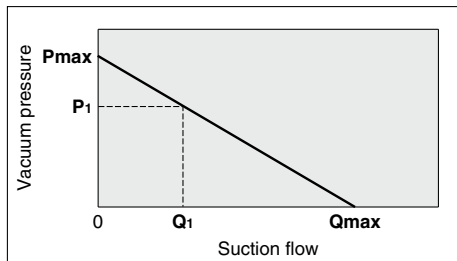

The flow rate characteristics indicate the relationship between the vacuum pressure and the suction flow of the ejector. They also show that when the suction flow changes, the vacuum pressure also changes. In general, this indicates the relationship at the ejector's standard operating pressure.

In the graph, **Pmax** indicates the max. vacuum pressure, and **Qmax** indicates the max. suction flow. These are the values that are published as specifications in catalogs, etc. Changes in vacuum pressure are explained in the order below.

1. If the ejector's suction port is closed and sealed tight, the suction flow becomes "0," and the vacuum pressure increases to the max. (**Pmax**).
2. If the suction port is opened gradually and air is allowed to flow (the air leaks), the suction flow increases, and the vacuum pressure decreases. (The condition of **P1** and **Q1**)
3. If the suction port is opened completely, the suction flow increases to the max. (**Qmax**), while the vacuum pressure then drops almost to "0" (atmospheric pressure).

As described above, the vacuum pressure changes when the suction flow changes. In other words, when there is no leakage from the vacuum (V) port, the vacuum pressure can reach its maximum, but as the amount of leakage increases, the vacuum pressure decreases. When the amount of leakage and the maximum suction flow become equal, the vacuum pressure becomes almost zero.

When adsorbing workpieces which are permeable, subject to leakage, etc., caution is required as the vacuum pressure will not be very high.

# Vacuum Manifold for Fieldbus System **ZKJ Series**

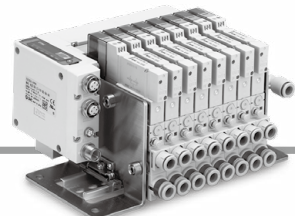

## Dimensions

ZZKJ□-□-□

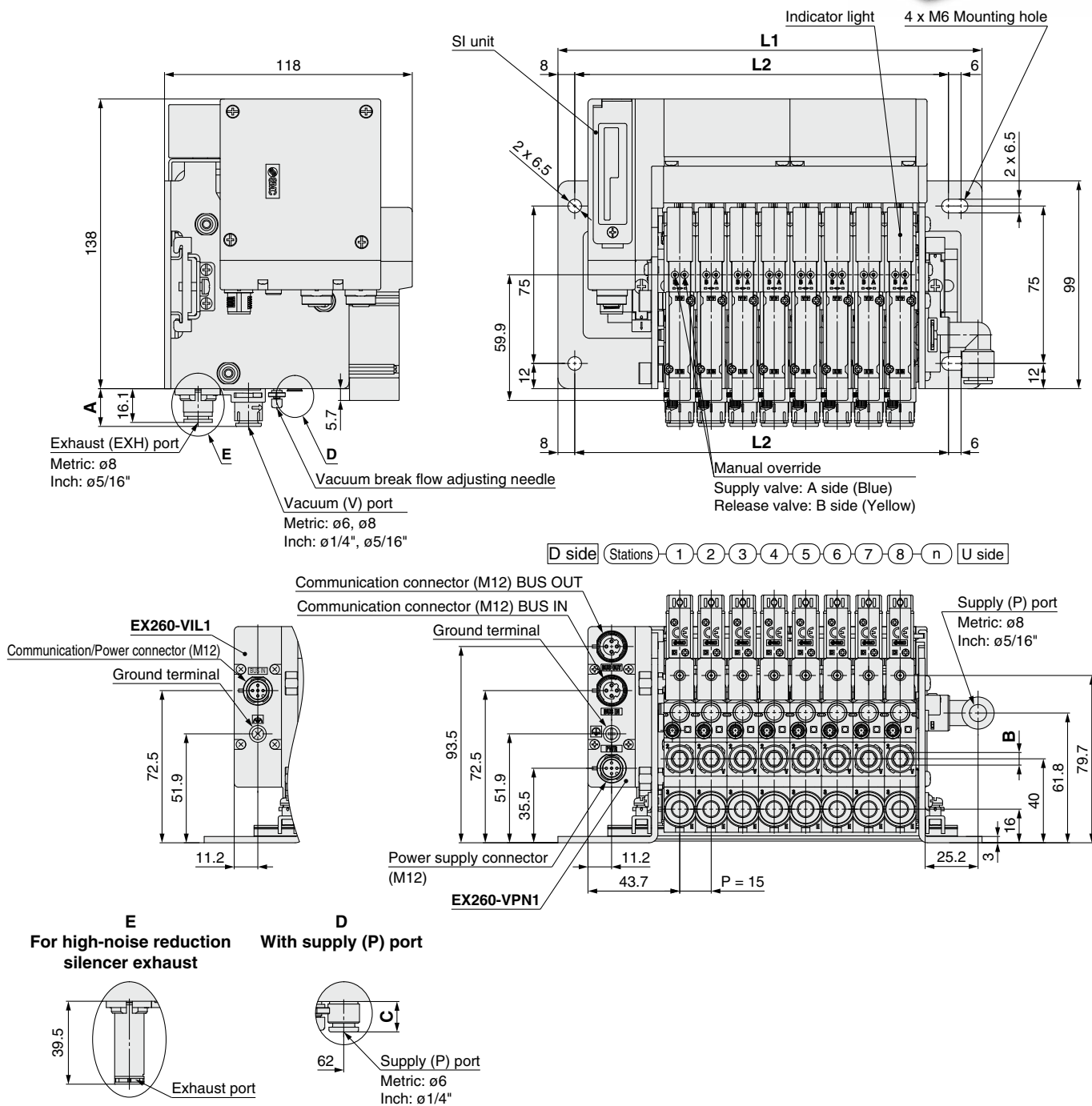

[mm]

Manifold stations	4	8	12	16
<b>L1</b>	142	202	262	322
<b>L2</b>	118	178	238	298
Port type	A	Hexagon width across flats B		C
Metric	C6 $\varnothing 6$	14.8	4	9.7
	C8 $\varnothing 8$	18	6	—
Inch	N7 $\varnothing 1/4$ "	16.3	4.76	12.3
	N9 $\varnothing 5/16$ "	18	6	—

## Air Circuit Diagram

### Without exhaust sealing valve

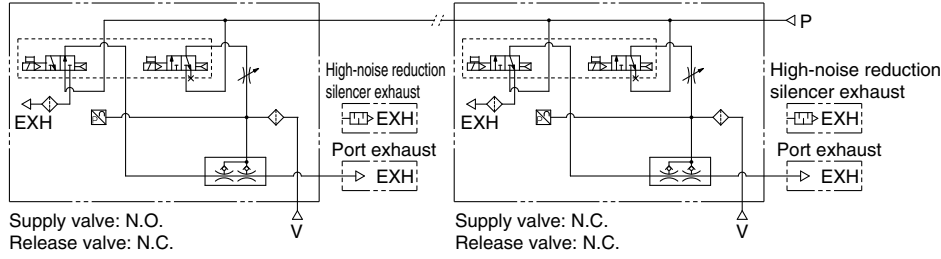

### Without exhaust sealing valve/With manual override for residual pressure release

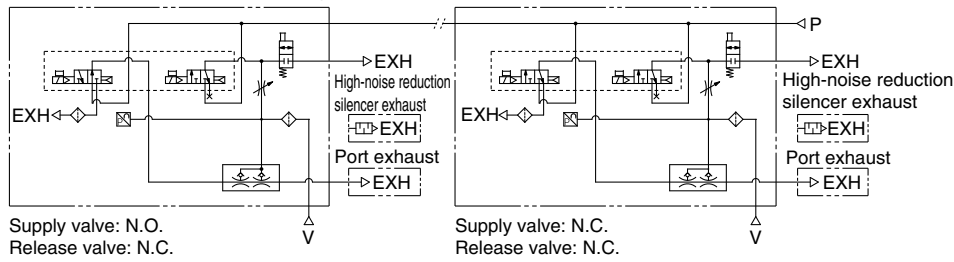

### With exhaust sealing valve

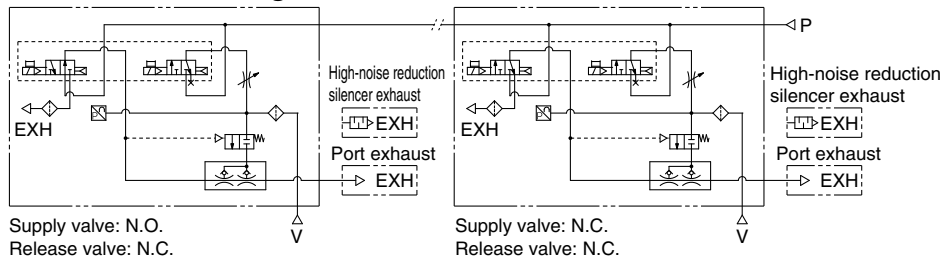

## Construction

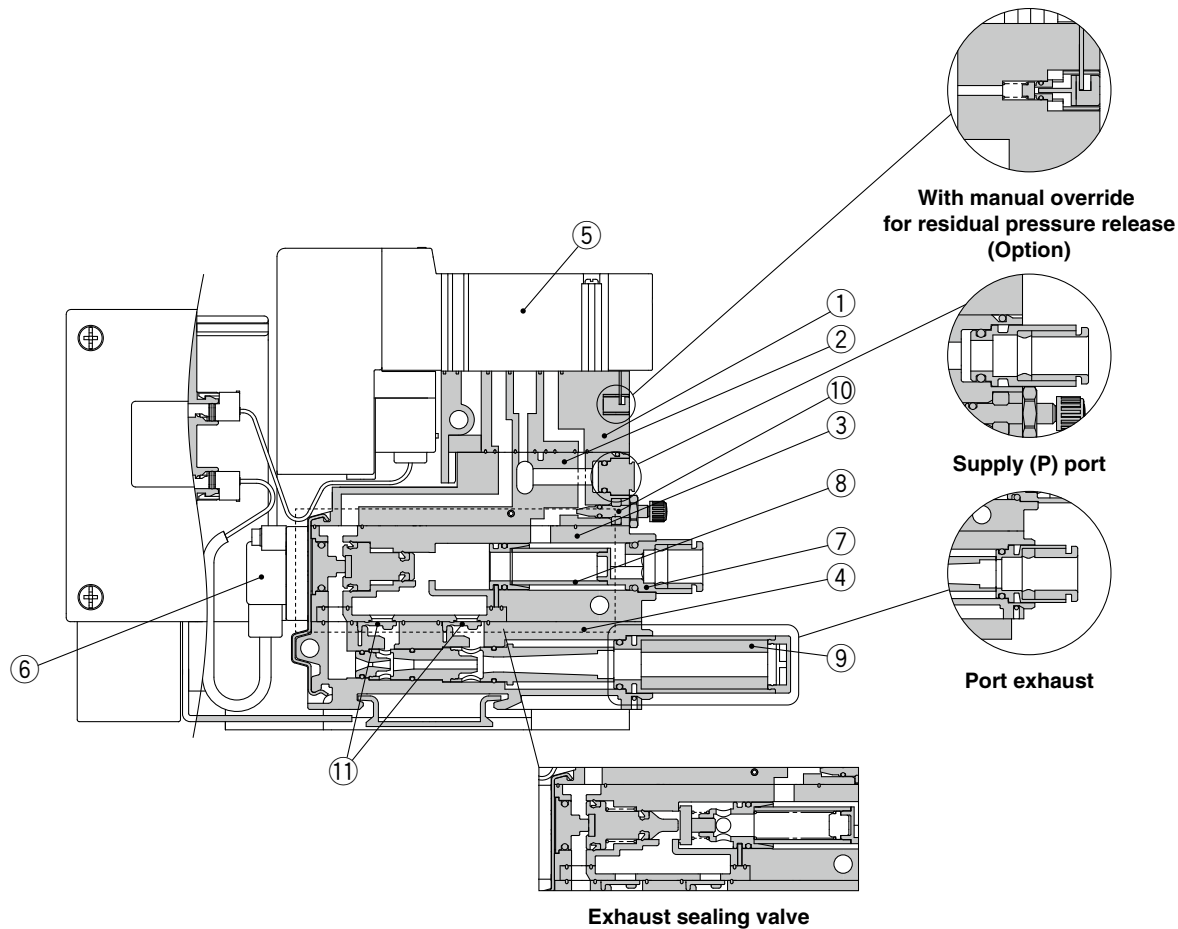

### Component Parts

No.	Description	Material	Note
1	Valve adapter assembly	PBT	FKM, HNBR, Stainless steel, and Aluminum are also used.
2	Valve body assembly	PBT	FKM and Stainless steel are also used.
3	Sealing valve body assembly	PBT	FKM, HNBR, Stainless steel, and Aluminum are also used.
4	Ejector body assembly	PBT	HNBR and Stainless steel are also used.
5	Supply valve and release valve assembly	—	Refer to page 18 for replacement parts.
6	Pressure sensor assembly	—	—
7	Vacuum port adapter assembly	—	Refer to page 18 for replacement parts. With One-touch fitting and filter element (With spring when exhaust sealing valve specification)
8	Filter element	Non-woven fabric	Refer to page 18 for replacement parts. Nominal filtration rating: 30 μm, 10 pcs. per set
9	High-noise reduction silencer assembly	POM, PVA	Refer to page 28 for replacement procedure. With sound absorbing material
10	Needle assembly	Brass	Electroless nickel plated brass, resin, steel and FKM are used.
11	Check valve	HNBR	When option "Y" is selected, the check valve on the left side as shown in the above figure is not mounted





## How to Order Replacement Parts

- ⑤ **Supply Valve and Release Valve Assembly** [With two mounting screws]  
 (Tightening torque for mounting screw: 0.2 N·m)

**ZKJ - JSY3** **A** **00 - 5U**

- **Supply valve/Release valve combination**

Symbol	Supply valve	Release valve
<b>A</b>	N.C.	N.C.
<b>E</b>	N.O.	N.C.

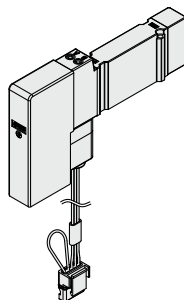

- ⑦ **Vacuum port adapter assembly** (Purchasing order is available in units of 1 piece.)

**ZK2 - VA1S** **8** **F** **V** - **A**

- **One-touch fitting size**

<b>6</b>	ø6	Metric
<b>8</b>	ø8	
<b>7</b>	ø1/4"	Inch
<b>9</b>	ø5/16"	

- **Exhaust sealing valve specification**

<b>Nil</b>	For ejector without exhaust sealing valve
<b>V</b>	For ejector with exhaust sealing valve (With spring)

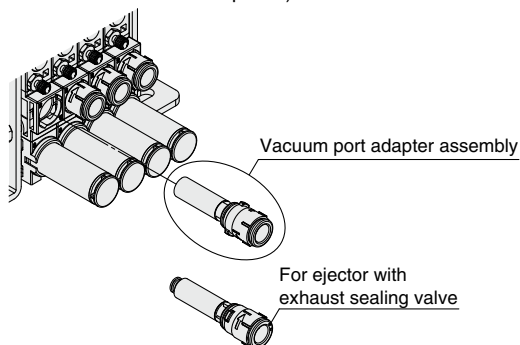

For replacement procedure, refer to the "Specific Product Precautions" on page 27.

- ⑧ **Filter element** (10 pcs. per set)

**ZK2 - FE1 - 3 - A**

- **Nominal filtration rating**

<b>3</b>	30 μm
----------	-------

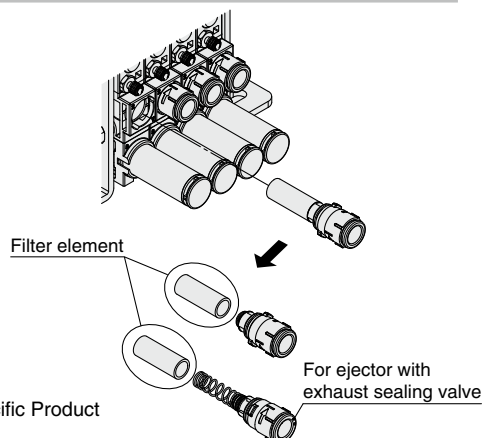

For replacement procedure, refer to the "Specific Product Precautions" on page 27.

- ⑨ **High-noise reduction silencer assembly**

**ZK2 - SC3F - 4 - A**

- **Applicable nozzle size**

<b>4</b>	For nozzle size 07, 10
<b>6</b>	For nozzle size 12, 15

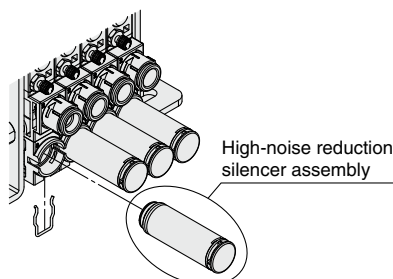

For replacement procedure, refer to the "Specific Product Precautions" on page 28.

- Sound absorbing material for high-noise reduction silencer** (5 pcs. per set)

**ZK2 - SE4 - 6 - A**

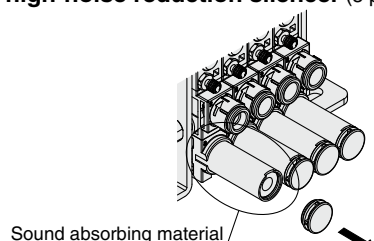

# ZKJ Series

# Exploded View of Manifold

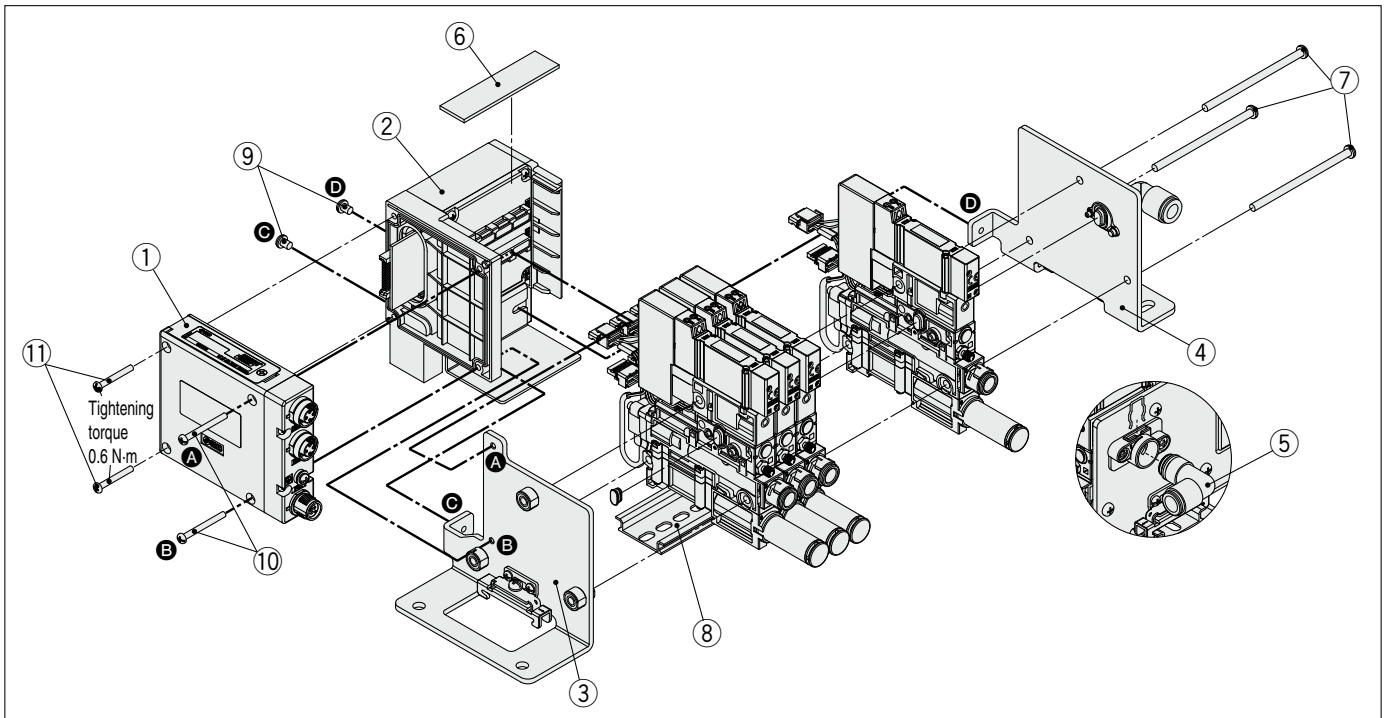

## Component Parts

No.	Description	Material	Note
1	SI unit	—	Refer to ① below for replacement parts.
2	Control unit	—	Refer to ② below for replacement parts.
3	D-side end plate	Stainless steel	—
4	U-side end plate	Stainless steel	—
5	Elbow type One-touch fitting assembly	—	Refer to ⑤ below for replacement parts.

No.	Description	Material	Note
6	Protection plate	PC	Refer to ⑥ below for replacement parts.
7	Tension bolt	Steel	Refer to ⑦ below for replacement parts.
8	DIN rail	Aluminum	Refer to ⑧ below for replacement parts.
9	Round head combination screw	Steel	Refer to ⑨ below for replacement parts.
10	Round head combination screw	Steel	Refer to ⑩ below for replacement parts.
11	Round head combination screw	Steel	Refer to ⑪ below for replacement parts.

### ① SI unit

EX260 - V **PN** 1

#### SI unit specifications

Symbol	Protocol
PN	PROFINET
IL	IO-Link

### ⑦ Tension bolt (3 pcs. per set)

ZKJ - TB1 - **4** - A

#### Length symbol

4	Manifold stations: 4 stations
8	Manifold stations: 8 stations
12	Manifold stations: 12 stations
16	Manifold stations: 16 stations

### ② Control unit

ZKJ - S0 **04** - A

#### Length symbol

04	Manifold stations: 4 stations
08	Manifold stations: 8 stations
12	Manifold stations: 12 stations
16	Manifold stations: 16 stations

### ⑧ DIN rail

VZ1000 - 11 - 1 - **1**

#### Length symbol

1	Manifold stations: 4 stations (Length: 110.5 mm)
6	Manifold stations: 8 stations (Length: 173 mm)
10	Manifold stations: 12 stations (Length: 223 mm)
15	Manifold stations: 16 stations (Length: 285.5 mm)

### ⑤ Elbow type One-touch fitting assembly

SZ3000 - 74 - 1A - L8 (ø8 elbow)

KQ2L09 - 14 - X224 (ø5/16" elbow)

### ⑨ Round head combination screw (10 pcs. per set)

ZKJ - TB2 - A (M4 x 5)

### ⑩ Round head combination screw (10 pcs. per set)

ZKJ - TB3 - A (M3 x 30)

### ⑪ Round head combination screw (10 pcs. per set)

ZKJ - TB4 - A (M3 x 24)

### ⑥ Protection plate

ZKJ - PL2 - **4** - A

#### Length symbol

4	Manifold stations: 4 stations
8	Manifold stations: 8 stations
12	Manifold stations: 12 stations
16	Manifold stations: 16 stations

## How to Increase Manifold Stations

- 1 Remove two screws from the back of the Control Unit and two screws from the side of SI Unit.

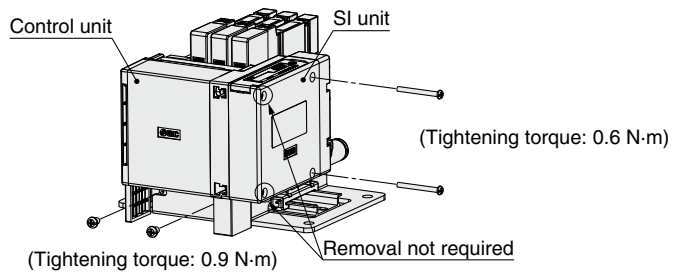

- 2 Separate the connected ejectors from the Control Unit.

- 3 Loosen the screw of the DIN rail mounting bracket on the End plate U as shown below (Removal not required)

- 4 Remove three tension bolts.

- 5 Remove the End plate U from the DIN rail.

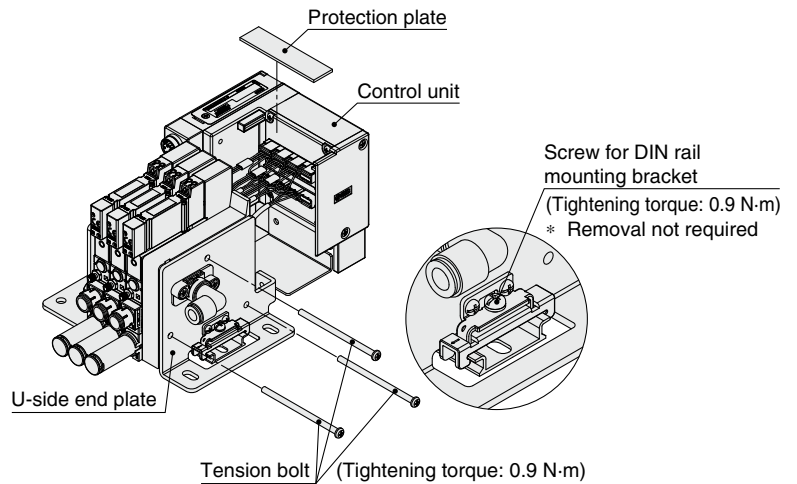

- 6 Remove the Protection plate.

- 7 Separate the blanking plate from the connected ejectors and remove the hook from the groove by pressing the blanking plate as shown Fig. Remove the blanking plate from the DIN rail.

- 8 Remove the connector plug assembly connected to the Control unit. To detach the connector, hold the lever and connector body. Remove the hook from the groove by pressing the lever downward, and pull the connector straight out.

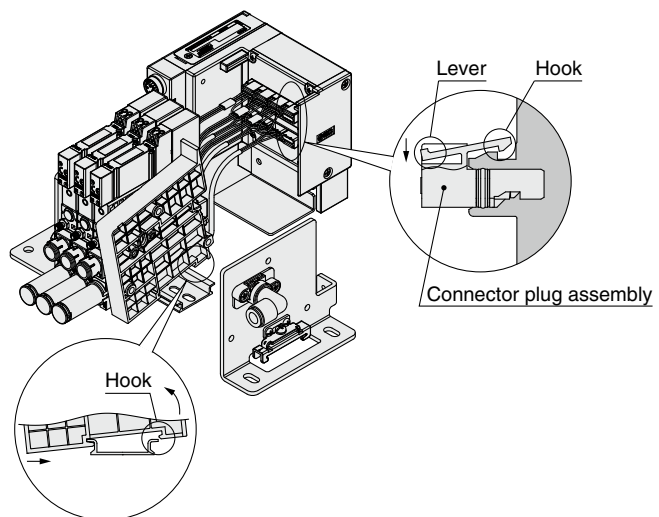

- 9 Mount the ejector to be added on the DIN rail, and align and connect the air passages of ejectors so that the lead wires do not get caught.

- 10 Insert the supply valve and release valve assembly connector to the top of the Control Unit (VALVE), and the pressure sensor assembly connector to the bottom of the Control Unit (SENSOR). Lock the connectors by pushing the lever hook into the concave groove on the housing.

- 11 Mount each of the removed parts by following steps 1 to 6 in reverse.

### When exchanging the first station

When exchanging to the vacuum ejector, order the vacuum ejector with the plug for individual supply (option M).

When exchanging to the blanking plate, order the blanking plate and the plug for individual supply separately. Refer to "Manifold Options" on page 21.

When increasing over 4, 8, 12 manifold stations, exchange the Control Unit, Tension bolts, Protection plate and DIN rail for suitable parts for manifold stations. Refer to Exploded View of Manifold on page 19.

# ZKJ Series Manifold Options

## Manifold Options

### ■ Blanking plate

[With two connector plug assembly]

Used in situations where ejectors are not mounted for manifold.

**ZKJ - BP1 - A**

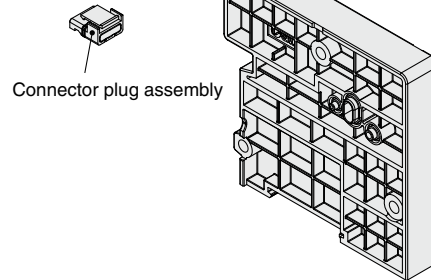

### ■ Plug for individual supply

By placing "Plug for individual supply" in an ejector manifold's pressure supply passage, two different pressures can be supplied to one manifold.

The supply (P) port for vacuum manifold is mounted only on the U side. Be sure to select the supply (P) port for ejector model number on the D side of the ejector where the plug for individual supply is mounted.

**ZK2 - MP2F - A**

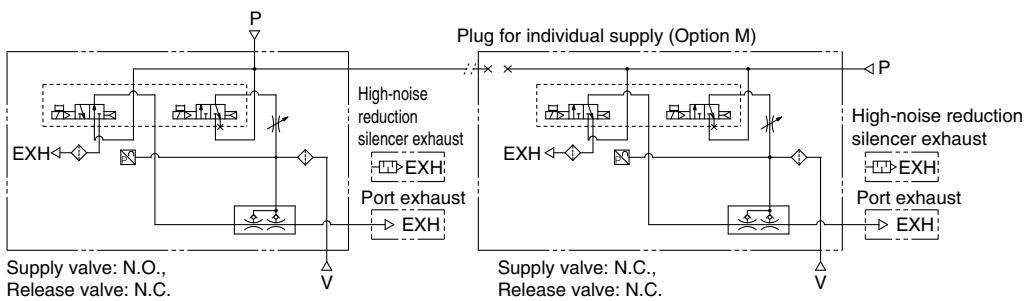
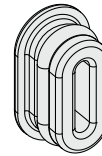

# ZKJ Series Accessories

## ① Communication Cable

For PROFINET

EX9-AC 005 EN-PSPS (With connector on both sides (Plug/Plug))

● Cable length (L)

005	500 mm
010	1000 mm
020	2000 mm
030	3000 mm
050	5000 mm
100	10000 mm

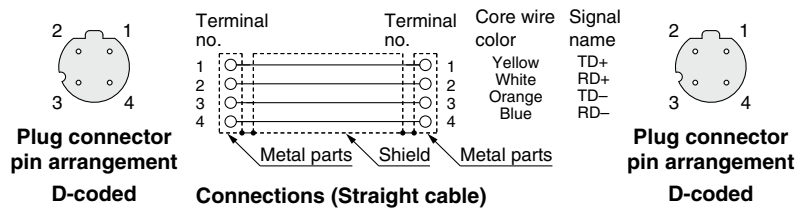
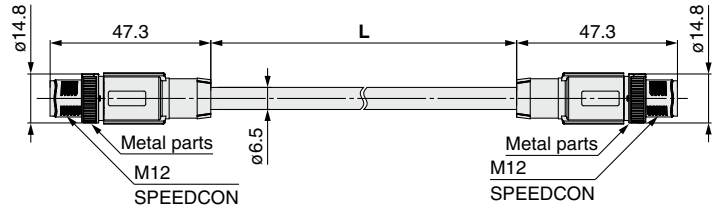

Item	Specifications
Cable O.D.	ø6.5 mm
Conductor nominal cross section	0.34 mm <sup>2</sup> /AWG22
Wire O.D. (Including insulator)	1.55 mm
Min. bending radius (Fixed)	19.5 mm

EX9-AC 005 EN-PAPA (With angled connector on both sides (Plug/Plug))

● Cable length (L)

005	500 mm
010	1000 mm
020	2000 mm
030	3000 mm
050	5000 mm
100	10000 mm

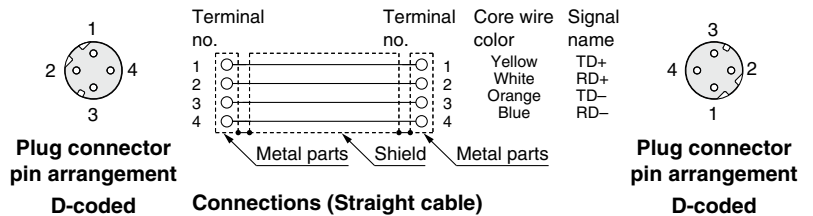
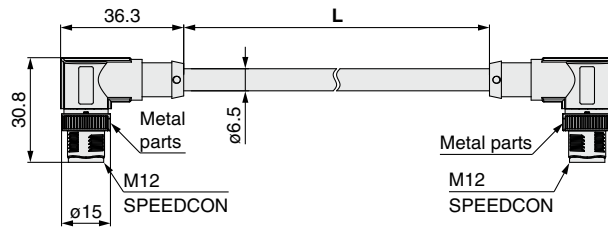

Item	Specifications
Cable O.D.	ø6.5 mm
Conductor nominal cross section	0.34 mm <sup>2</sup> /AWG22
Wire O.D. (Including insulator)	1.55 mm
Min. bending radius (Fixed)	19.5 mm

# ZKJ Series

## ① Communication Cable

### For PROFINET

#### EX9-AC 020 EN-PSRJ (Plug/RJ-45 connector)

##### ● Cable length (L)

010	1000 mm
020	2000 mm
030	3000 mm
050	5000 mm
100	10000 mm

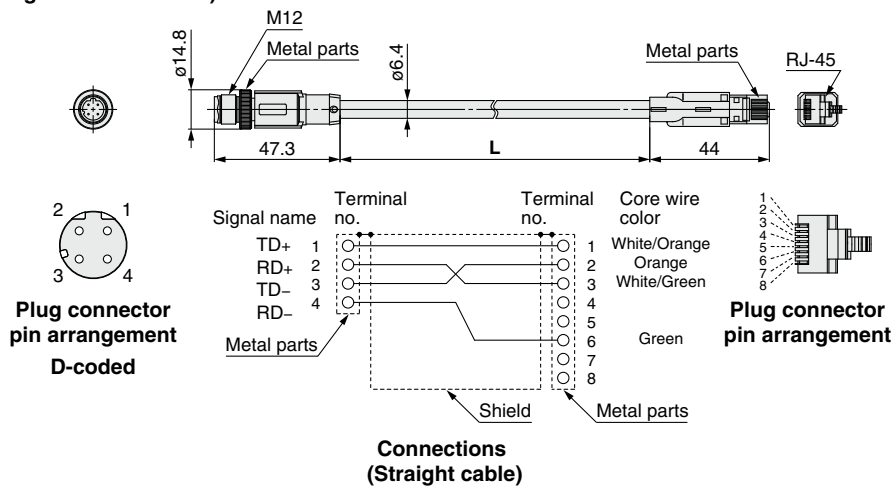

Item	Specifications
<b>Cable O.D.</b>	$\phi 6.4$ mm
<b>Conductor nominal cross section</b>	0.14 mm <sup>2</sup> /AWG26
<b>Wire O.D. (Including insulator)</b>	0.98 mm
<b>Min. bending radius (Fixed)</b>	26 mm

#### PCA-1446566 (Plug)

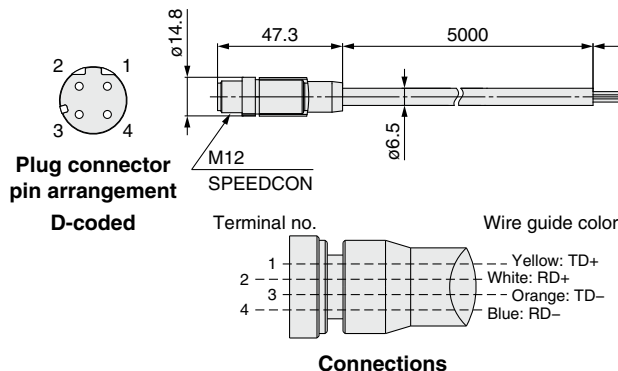

Item	Specifications
<b>Cable O.D.</b>	$\phi 6.5$ mm
<b>Conductor nominal cross section</b>	0.34 mm <sup>2</sup> /AWG22
<b>Wire O.D. (Including insulator)</b>	1.55 mm
<b>Min. bending radius (Fixed)</b>	19.5 mm

## ① Communication Cable

### For IO-Link

#### Connection examples

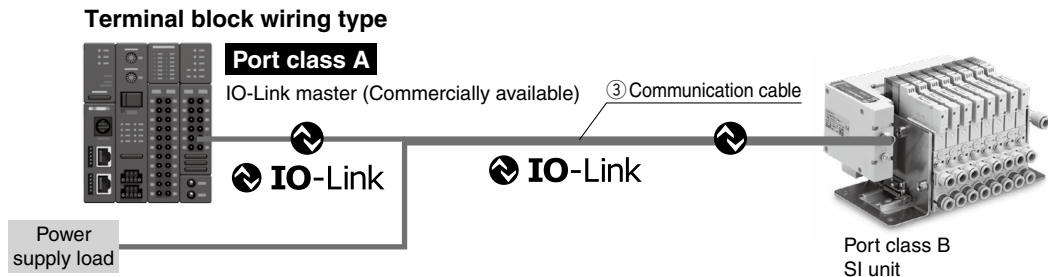
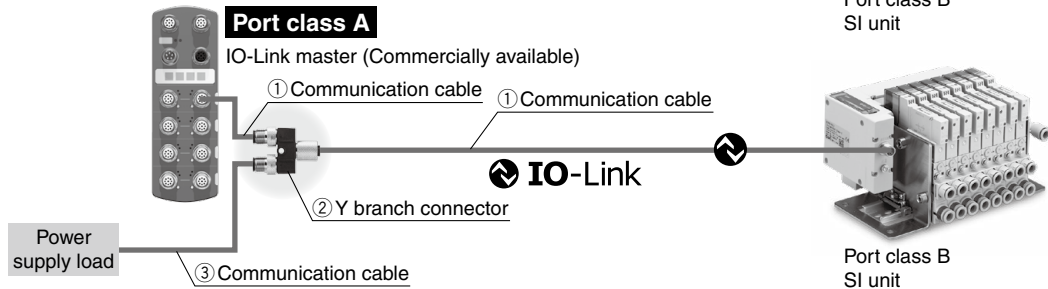
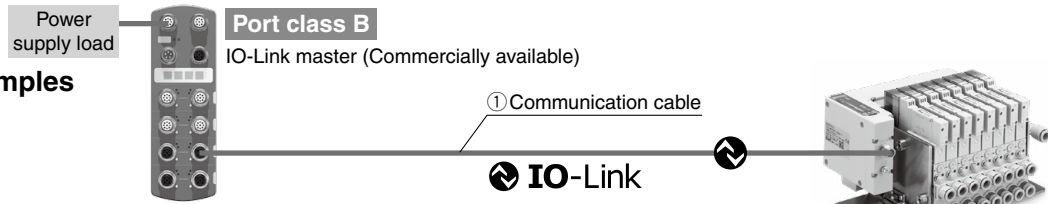

### ① Communication cable

#### EX9-AC 005 -SSPS (With connector on both sides (Socket/Plug))

##### • Cable length (L)

005	500 mm
010	1000 mm
020	2000 mm
030	3000 mm
050	5000 mm
100	10000 mm

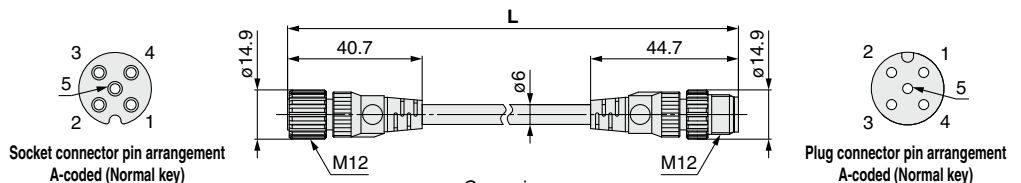

Terminal no.	Core wire color
1	Brown
2	White
3	Blue
4	Black
5	Gray

##### Connections

Item	Specifications
<b>Cable O.D.</b>	ø6 mm
<b>Conductor nominal cross section</b>	0.3 mm <sup>2</sup> /AWG22
<b>Wire O.D. (Including conductor)</b>	1.5 mm
<b>Min. bending radius (Fixed)</b>	40 mm

#### EX9-AC 005 -SAPA (With connector on both sides (Socket/Plug))

##### • Cable length (L)

005	500 mm
010	1000 mm
020	2000 mm
030	3000 mm
050	5000 mm
100	10000 mm

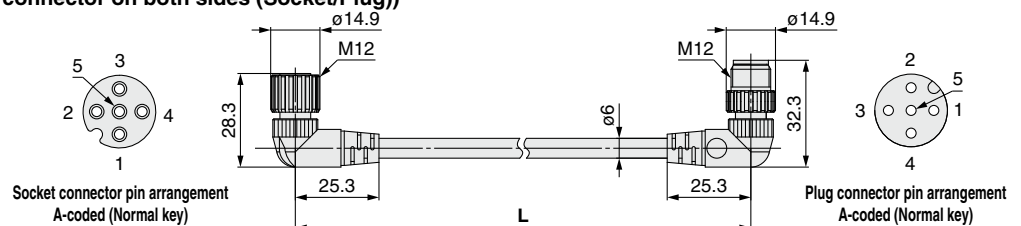

Terminal no.	Core wire color
1	Brown
2	White
3	Blue
4	Black
5	Gray

##### Connections

Item	Specifications
<b>Cable O.D.</b>	ø6 mm
<b>Conductor nominal cross section</b>	0.3 mm <sup>2</sup> /AWG22
<b>Wire O.D. (Including conductor)</b>	1.5 mm
<b>Min. bending radius (Fixed)</b>	40 mm

# ZKJ Series

## ① Communication Cable

### For IO-Link

#### ② Y branch connector

This connector is used to supply output power by branching the IO-Link communication cable when a port class A IO-Link master is used.

#### EX9-ACY02-S

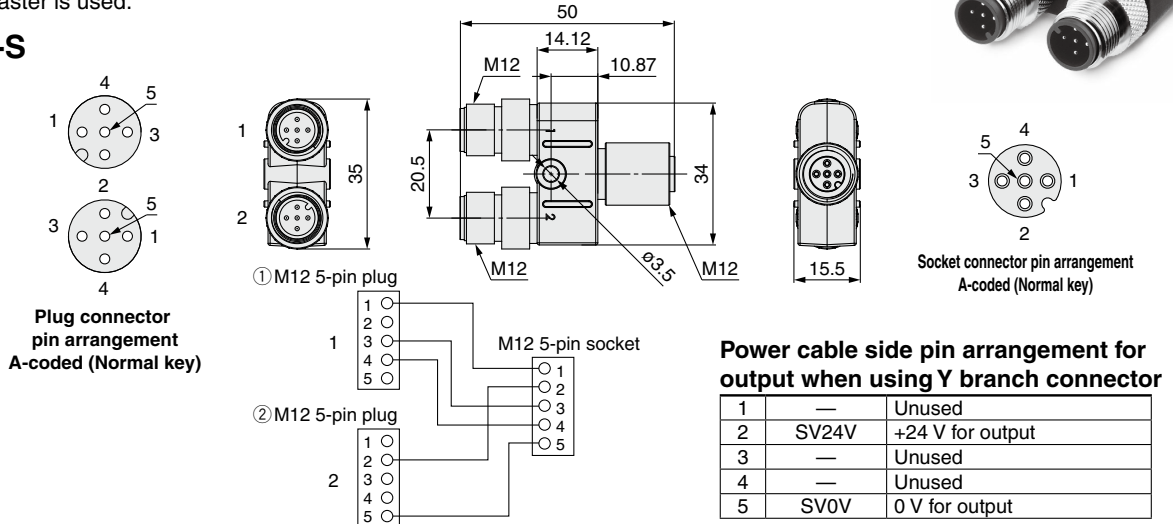

#### ③ Communication cable

#### EX500-AP 050 -S

##### Cable length (L)

010	1000 mm
050	5000 mm

##### Connector specification

S	Straight
A	Angled

##### Straight connector type

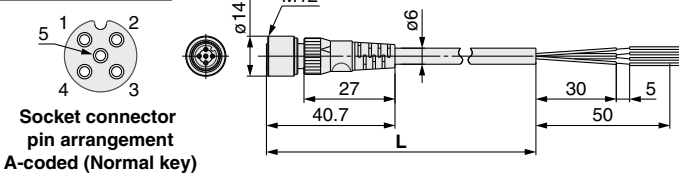

Item	Specifications
Cable O.D.	ø6 mm
Conductor nominal cross section	0.3 mm <sup>2</sup> /AWG22
Wire O.D. (Including insulator)	1.5 mm
Min. bending radius (Fixed)	40 mm

##### Angled connector type

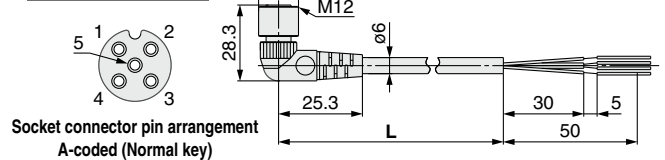

Item	Specifications
Cable O.D.	ø6 mm
Conductor nominal cross section	0.3 mm <sup>2</sup> /AWG22
Wire O.D. (Including insulator)	1.5 mm
Min. bending radius (Fixed)	40 mm



Made to Order

Cable length	10000 mm	Web Catalog
--------------	----------	-------------

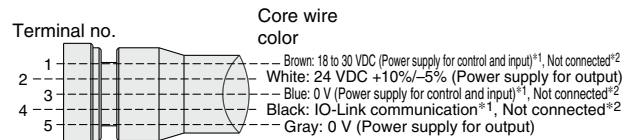

##### Connections (IO-Link)

- \*1 When used as an IO-Link communication cable
- \*2 When used as a solenoid valve power supply cable

#### PCA-1401804

##### Cable length (L)

1401804	1500 mm
1401805	3000 mm
1401806	5000 mm

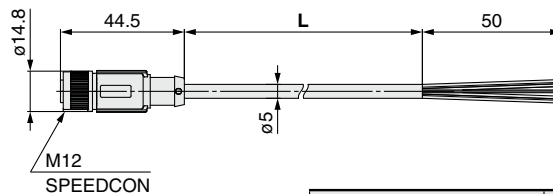
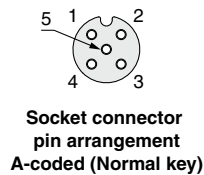

Item	Specifications
Cable O.D.	ø5 mm
Conductor nominal cross section	0.34 mm <sup>2</sup> /AWG22
Wire O.D. (Including insulator)	1.27 mm
Min. bending radius (Fixed)	21.7 mm

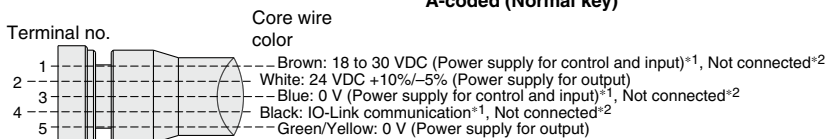

##### Connections (IO-Link)

- \*1 When used as an IO-Link communication cable
- \*2 When used as an output power supply cable



## ② Field-wireable Communication Connector

For PROFINET

PCA-1446553

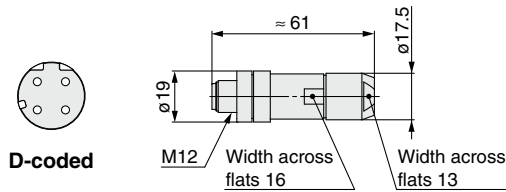

### Applicable Cable

Item	Specifications
Cable O.D.	4.0 to 8.0 mm
Wire gauge (Stranded wire cross section)	0.14 to 0.34 mm <sup>2</sup> /AWG26 to 22

\* The table above shows the specifications for the applicable cable. Adaptation for the connector may vary on account of the conductor construction of the electric wire.

## ③ Power Supply Cable

For PROFINET

EX500-AP 050 - S

Cable length (L)

010	1000 mm
050	5000 mm

Connector specification

S	Straight
A	Angled

### Straight connector type

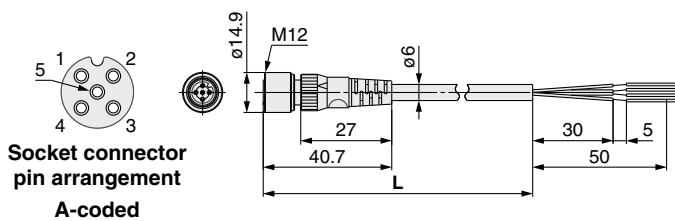

Item	Specifications
Cable O.D.	ø6 mm
Conductor nominal cross section	0.3 mm <sup>2</sup> /AWG22
Wire O.D. (Including insulator)	1.5 mm
Min. bending radius (Fixed)	40 mm

### Angled connector type

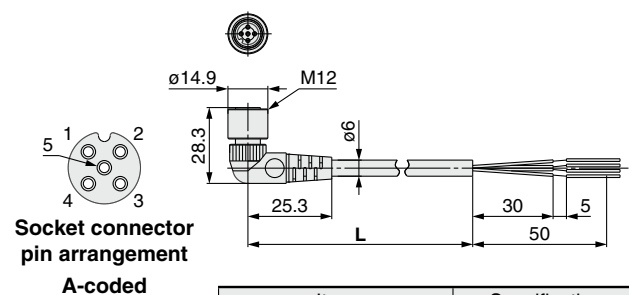

Item	Specifications
Cable O.D.	ø6 mm
Conductor nominal cross section	0.3 mm <sup>2</sup> /AWG22
Wire O.D. (Including insulator)	1.5 mm
Min. bending radius (Fixed)	40 mm

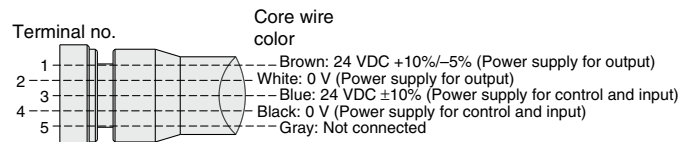

### Connections

PCA-1401804

Cable length (L)

1401804	1500 mm
1401805	3000 mm
1401806	5000 mm

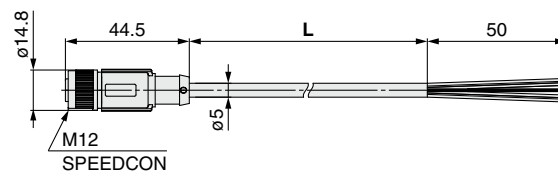
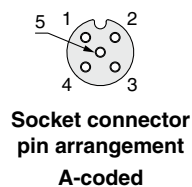

Item	Specifications
Cable O.D.	ø5 mm
Conductor nominal cross section	0.34 mm <sup>2</sup> /AWG22
Wire O.D. (Including insulator)	1.27 mm
Min. bending radius (Fixed)	21.7 mm

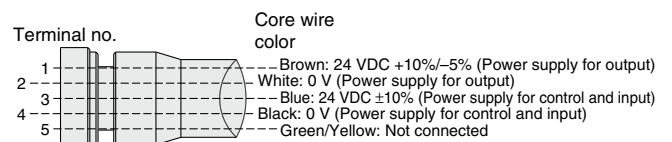

### Connections

# ZKJ Series

## ③ Power Supply Cable



With connector on one side (Socket)

Cable length: 10000 mm

EX500-AP100-**S**-X1

• Connector specification

<b>S</b>	Straight
<b>A</b>	Angled

### Straight connector type

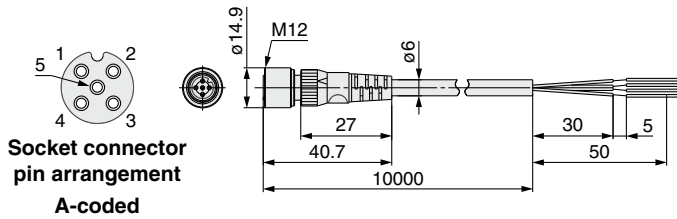

Item	Specifications
Cable O.D.	ø6 mm
Conductor nominal cross section	0.3 mm <sup>2</sup> /AWG22
Wire O.D. (Including insulator)	1.5 mm
Min. bending radius (Fixed)	40 mm

### Angled connector type

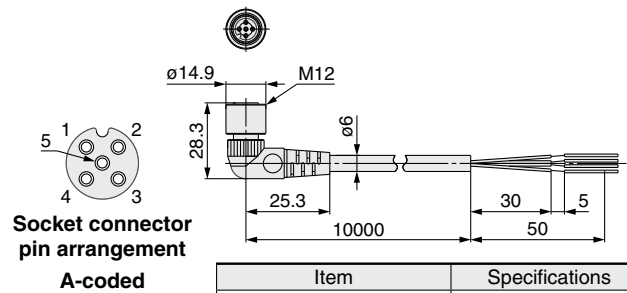

Item	Specifications
Cable O.D.	ø6 mm
Conductor nominal cross section	0.3 mm <sup>2</sup> /AWG22
Wire O.D. (Including insulator)	1.5 mm
Min. bending radius (Fixed)	40 mm

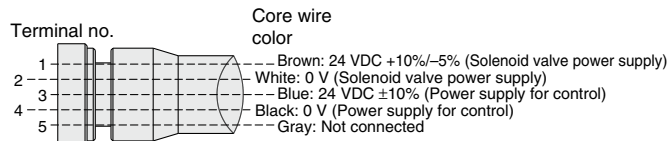

### Connections

## ④ Seal Cap (10 pcs.)

Use this on ports that are not being used for communication connector (M12 connector socket).

Use of this seal cap maintains the integrity of the IP65 enclosure.

\* Tighten the seal cap with the prescribed tightening torque. (For M12: 0.1 N·m)

EX9-AW TS

• Connector specification

<b>TS</b>	For M12 connector socket (10 pcs.)
-----------	------------------------------------

One waterproof cap is provided for an EX260-VPN1.

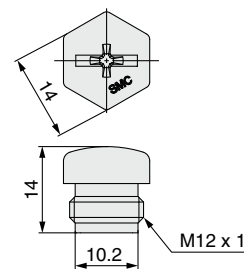

For M12 connector socket



# ZKJ Series

## Specific Product Precautions 1

Be sure to read this before handling the products. Refer to the back cover for safety instructions. For vacuum equipment precautions, refer to the “Handling Precautions for SMC Products” and the “Operation Manual” on the SMC website: <https://www.smcworld.com>

### Design / Selection

#### Warning

##### 1. Confirm the specifications.

Products represented in this catalog are designed only for use in compressed air systems (including vacuum).

Do not operate at pressures, temperatures, etc., beyond the range of specifications, as this can cause damage or malfunction. (Refer to the specifications.)

Please contact SMC when using a fluid other than compressed air (including vacuum).

We do not guarantee against any damage if the product is used outside of the specification range.

##### 2. Do not use the product to drive an actuator such as a cylinder (when release pressure is constantly applied).

Failure to do so may lead to performance issues or damage to the body of the product.

##### 3. Vacuum pressure

Since valves are subject to air leakage, they cannot be used for applications such as holding vacuum in a pressure vessel. SMC can issue no guarantees regarding the maintenance of workpiece adsorption when using check valves. Take separate safety measures to prevent workpieces from dropping in the case of an electrical power outage, etc.

##### 4. Cannot be used as an emergency shutoff valve, etc.

The valves presented in this catalog are not designed for safety applications such as an emergency shutoff valve. If the valves are used in this type of system, other reliable safety assurance measures should also be adopted.

##### 5. Release of residual pressure

For maintenance and inspection purposes, ensure to install the residual pressure release system when piping.

##### 6. Workpiece adsorption

When adsorbing the workpiece, ensure to turn on the vacuum instruction signal. Failure to do so may result in foreign matter sticking to the adsorption pad or air leakage, causing the workpiece to drop.

##### 7. Ventilation

Provide ventilation when using a vacuum ejector in a confined area, such as in a closed control panel. For example, install a ventilation opening, etc., in order to prevent pressure from increasing inside of the confined area and to release the heat generated by the valve.

##### 8. Extended periods of continuous energization

If a valve will be continuously energized for an extended period of time, the temperature of the valve will increase due to the heat generated by the coil assembly. This will likely adversely affect the performance of the valve and any nearby peripheral equipment. Therefore, if the valve is to be energized for periods of longer than 30 minutes at a time, or if during the hours of operation the energized period per day is longer than the de-energized period, we advise using a N.O. (normally open) valve.

##### 9. Resumption after a long period of holding time

When resuming operation after a long period of holding time, there are cases in which, regardless of whether the product is in an ON or OFF state, there is a delay in the initial response time due to adhesion. Conducting several cycles of running-in operation will solve this problem. Please consider implementing this before resumption.

### Design / Selection

#### Caution

##### 1. For specific product precautions on solenoid valves, refer to the solenoid valve (JSY3000 series) catalog.

##### 2. For specific product precautions on pressure sensors, refer to the pressure sensor (PSE54□ series) catalog.

### Supply Valve / Release Valve

#### Warning

##### 1. Manual override operation

Regardless of an electric signal for the valve, the manual override is used for switching the main valve. Connected actuator is started by manual operation. A diagnosis information may occur when using the manual override during fieldbus communication. Use the manual override when the power supply is turned off.

Manual override is non-locking push type. Push the manual override with a screwdriver of a diameter smaller than indicated in the diagram until it reaches the end.

Supply valve manual override  
A (Blue)

Release valve manual override  
B (Yellow)

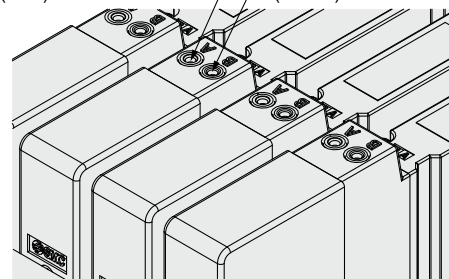

##### 2. Energization

When workpiece is being adsorbed, please keep generating the vacuum pressure to prevent the workpiece from dropping. Do not perform the operation to generate vacuum and release pressure at the same time as this may cause malfunction.



# ZKJ Series Specific Product Precautions 2

Be sure to read this before handling the products. Refer to the back cover for safety instructions. For vacuum equipment precautions, refer to the “Handling Precautions for SMC Products” and the “Operation Manual” on the SMC website: <https://www.smcworld.com>

## Supply Valve / Release Valve

### Warning

#### 3. LED indication

Red LED turns on when supply valve is energized. Green LED turns on when release valve is energized.

LED light position

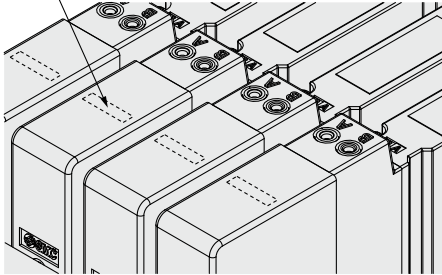

#### 4. Air leakage

Zero air leakage is not guaranteed for the supply valve or release valve.

Be aware that because there is a chance of air and vacuum leakage, the pressure may change if the V port side is tightly sealed.

## Manual Override for Residual Pressure Release

### Warning

V port is released to atmosphere when performing the manual override for residual pressure release. Please perform after ensuring measured are in place to prevent the workpieces from dropping, etc.

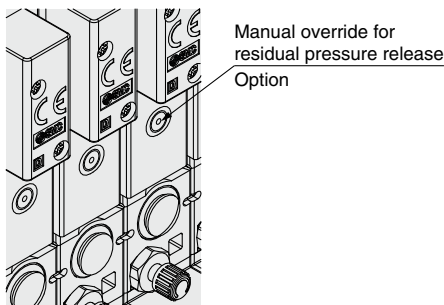

## Replacement Procedure

### Caution

Be sure to install the filter element. If the filter element is not installed, this can result reduced performance.

#### 1. Replacement Procedure for Filter Element

- 1) To pull out the vacuum port adapter, rotate the adapter by about 90 degrees in direction A and pull in direction B. The adapter can be removed with the filter element from the sealing valve body.
- 2) Remove the filter element from the vacuum port adapter and replace it with a new filter element. When the ejector is exhaust sealing valve type, be careful not to drop the spring from the vacuum port adapter.

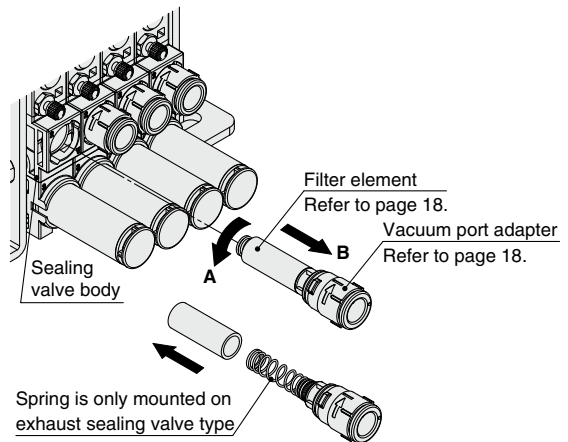

- 3) When installing the filter, insert the filter to the end so that there is no gap\*1 or bending\*2 between the filter and the vacuum port adapter.

A gap or bending will cause interference with internal parts, the filter element to deform and deterioration of the performance.

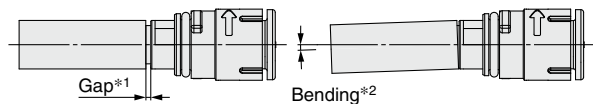

- 4) Put the filter element back into the sealing valve body following this procedure in reverse.

- To mount the vacuum port adapter into the sealing valve body, turn the adapter so that the mark of the adapter is on top (rotation stops there.).

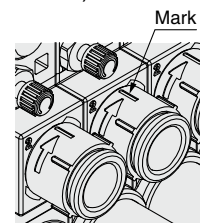

- If it is difficult to remove the vacuum port adapter, you can remove the adapter with a hexagon wrench using the hexagonal hole in V port. The table shows the port size and the width across flats.

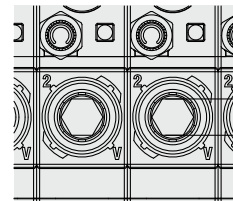

V port size	Width across flats
ø6	4
ø8, ø5/16"	6
ø1/4"	4.76



# ZKJ Series

## Specific Product Precautions 3

Be sure to read this before handling the products. Refer to the back cover for safety instructions. For vacuum equipment precautions, refer to the “Handling Precautions for SMC Products” and the “Operation Manual” on the SMC website: <https://www.smcworld.com>

### Replacement Procedure

#### ⚠ Caution

#### 2. Replacement Procedure for High-noise Reduction Silencer Assembly

- 1) Flip the ejector.
- 2) To remove the clip that holds the High-noise reduction silencer, insert a precision screwdriver. Move the screwdriver to pull out the clip.

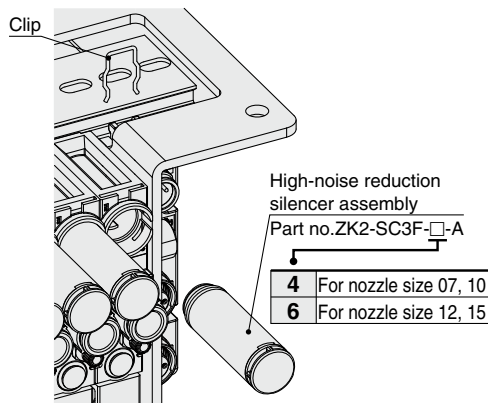

- 3) Remove the high-noise reduction silencer.

#### (Procedure to put parts back together)

- 4) Insert the High-noise reduction silencer and insert the clip into the groove. (Push completely to the end.)

\* Do not pull or bend the two projections at the end surface of the diffuser. These are spacers to prevent the displacement of the diffuser and they may break if force is applied.

### Replacement Procedure

#### ⚠ Caution

#### 3. When only replacing the sound absorbing material (for high-noise reduction silencer exhaust)

- 1) Use the notch to remove the cap.
- 2) Use a precision screwdriver to remove the sound absorbing material.
- 3) Insert the new sound absorbing material, and return the cap.

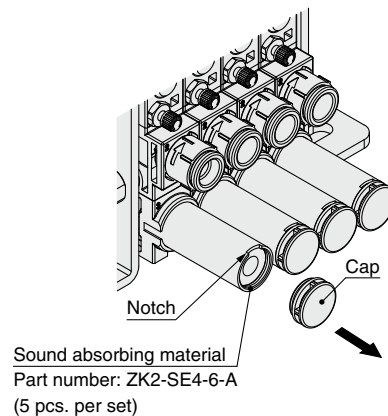

### Ejector Exhaust / Exhaust Noise

#### ⚠ Caution

#### 1. Ejector exhaust

The exhaust resistance should be as small as possible to obtain the full ejector performance. There should be no shield around the exhaust slit for silencer exhaust type.

For port exhaust type, ensure that the back pressure does not exceed 5 kPa. Increased back pressure may lead to the reduction of suction flow and delays in the transport cycle time. Do not operate the ejector or apply pressure to the exhaust port with the exhaust port closed. This increases the pressure in the product and can damage the vacuum ejector.

#### 2. Sound absorbing material

If the sound absorbing material is clogged, it will cause a reduction in the ejector performance.

Sometimes, if the operating environment contains a lot of particles or mist, the replacement of the filter element only is not enough to recover vacuum performance - as the sound absorbing material may be clogged.

Replace the sound absorbing material. (Regular replacement of the filter element and the sound absorbing material is recommended.)



# ZKJ Series

## Specific Product Precautions 4

Be sure to read this before handling the products. Refer to the back cover for safety instructions. For vacuum equipment precautions, refer to the “Handling Precautions for SMC Products” and the “Operation Manual” on the SMC website: <https://www.smcworld.com>

### Ejector Exhaust / Exhaust Noise

#### ⚠ Caution

##### 3. Exhaust noise

When vacuum ejector generates vacuum, noise can be heard from the exhaust port when the standard supply pressure is close to the pressure that generates peak vacuum pressure making vacuum pressure unstable. If the vacuum pressure range is adequate for adsorption, there should not be a problem. If the noise causes a problem or affects the setting of the SI unit, change the supply pressure slightly to avoid the pressure range of the noise.

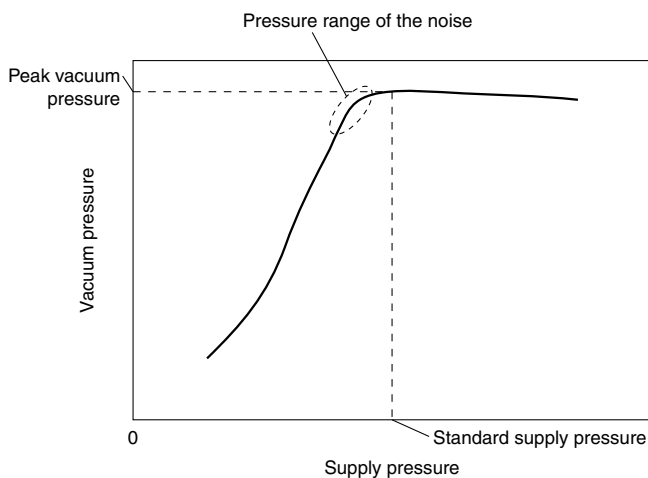

Models with a large nozzle diameter generate a large exhaust noise if the exhaust (EXH) port is opened. Install piping or a silencer to the exhaust port to reduce the exhaust noise.

##### 4. Exhaust air

If solid substances are sucked in through the vacuum (V) port, they will be discharged from the exhaust port at a high speed if the exhaust (EXH) port is opened. Therefore, do not look into the exhaust port or direct the exhaust port toward a person when the ejector is operating.

### Operating Supply Pressure

#### ⚠ Caution

Use the product within the specified supply pressure range. Operation over the max. operating pressure can cause damage to the product. The parts around the vacuum port of this product are designed to be used with vacuum pressure.

### Port Size

#### ⚠ Caution

##### 1. Air pressure supply (P) port

P port (End plate U) and P port (Ejector) are connected inside. For an adequate performance, the number of stations when operated simultaneously depends on the nozzle diameter. Refer to page 11 for the number of stations that can operate simultaneously for each ejector size.

### How to Mount a Manifold

#### ⚠ Caution

##### 1. Do not drop, hit, or apply excessive impact to the product when handling it.

Even if the body looks undamaged, the internal components may be damaged, leading to a malfunction.

##### 2. Load to the body

Do not lift the product by holding the One-touch fitting or high-noise reduction silencer. This may cause damage to the body. The product body is made of resin; therefore, do not apply load to the port after mounting. Prevent any kind of operation which generates moment as this may cause reduced performance or damage to the body.

##### 3. Installation

Manifold can be mounted onto the floor using M6 holes on the end plate. The DIN rail installed in the product is used for connecting the ejectors. Do not use mounting holes of the DIN rail to mount the product.

##### 4. Ensure sufficient space for maintenance activities.

When installing the products, allow access for maintenance and inspection.

### Vacuum Break Flow Adjusting Needle

#### ⚠ Caution

##### 1. The flow rate characteristics show the representative values of the product itself.

They may change depending on piping, circuit and pressure conditions, etc. The flow rate characteristics and the number of needle rotations vary due to the range of the specifications of the product.

##### 2. The needle has a retaining mechanism, so it will not turn further when it reaches the rotation stop position.

Turning the needle too far may cause damage.

##### 3. Do not tighten the handle with tools such as nippers.

This can result in breakage due to idle turning.

##### 4. Do not over tighten the lock nut.

It is possible to tighten the standard lock nut (hexagon) manually.

When tightening further with tools, tighten by approximately 15° to 30°. Over tightening may cause breakage.

##### 5. When vacuum break flow adjusting needle screwdriver operation type (-E) is selected as option, make sure the lock nut is not loose to prevent the nut from coming off due to vibration.

##### ■ Vacuum Release Air

When fully closed, leakage cannot be prevented completely. There is an allowance for a certain amount of leakage in the product's specifications. Tightening the needle to reduce leakage to zero may result in equipment damage.



## ZKJ Series

# Specific Product Precautions 5

Be sure to read this before handling the products. Refer to the back cover for safety instructions. For vacuum equipment precautions, refer to the “Handling Precautions for SMC Products” and the “Operation Manual” on the SMC website: <https://www.smcworld.com>

### Operating Environment

#### Warning

1. Do not use in an atmosphere containing corrosive gases, chemicals, sea water, water, water steam, or where there is direct contact with any of these.
2. **IP65 enclosure: The protection structure against solid foreign objects is dust-tight type and the protection structure against water is water-jet-proof type.**  
Dust-tight means that no dust can enter the inside of the equipment. Water-jet-proof means that the product is not adversely affected by direct water jets from any direction. That is, even when direct water jets are applied to the product for 3 minutes by means of the pre-determined method, there is no water entry that hinders the correct operation inside the equipment. Be sure to take appropriate protective measures if the product is to be used in an environment where it will be constantly exposed to water or fluids other than water splash. In particular, the product cannot be used in environments where oils, such as cutting oil or cutting fluid, are present.
3. **IP65 is achieved when the following conditions are met.**
  - 1) Provide appropriate wiring between the SI units using electrical wiring cables, communication connectors, and cables with M12 connectors.
  - 2) Suitable connecting of connectors for supply valve and release valve assembly, pressure sensor assembly and the control unit.
  - 3) Suitable mounting of SI Unit, control unit and vacuum ejectors.
  - 4) Be sure to fit a seal cap on any unused connectors.
4. **When the high performance silencer is used for an IP65 compliant manifold, prevent water from splashing onto the silencer outlet.**

### Piping

#### Caution

When piping to the product, be careful not to confuse a vacuum port with an exhaust port. Otherwise this can result in damage or reduced performance. Apply compressed air after confirming that the piping is connected correctly.

If each exhaust piping for the port exhaust ejectors are connected and made into centralized piping, the exhausted air will flow back into the exhaust path which is not operating, and will then be exhausted from the vacuum port. Exhaust individually.

### Adjustment / Operation

#### Caution

1. Please refer to the PLC manufacturer's manual, etc. for details of the SI unit programming and addresses.  
The programming content related to the protocol is designed by the manufacturer of the PLC used.
2. For the first operation, always perform zero clear with no pressure applied.

## Safety Instructions

These safety instructions are intended to prevent hazardous situations and/or equipment damage. These instructions indicate the level of potential hazard with the labels of “**Caution**,” “**Warning**” or “**Danger**.” They are all important notes for safety and must be followed in addition to International Standards (ISO/IEC)\*1), and other safety regulations.

 **Caution:** **Caution** indicates a hazard with a low level of risk which, if not avoided, could result in minor or moderate injury.

 **Warning:** **Warning** indicates a hazard with a medium level of risk which, if not avoided, could result in death or serious injury.

 **Danger :** **Danger** indicates a hazard with a high level of risk which, if not avoided, will result in death or serious injury.

\*1) ISO 4414: Pneumatic fluid power – General rules relating to systems.  
ISO 4413: Hydraulic fluid power – General rules relating to systems.  
IEC 60204-1: Safety of machinery – Electrical equipment of machines.  
(Part 1: General requirements)  
ISO 10218-1: Manipulating industrial robots – Safety.  
etc.

### Warning

#### 1. The compatibility of the product is the responsibility of the person who designs the equipment or decides its specifications.

Since the product specified here is used under various operating conditions, its compatibility with specific equipment must be decided by the person who designs the equipment or decides its specifications based on necessary analysis and test results. The expected performance and safety assurance of the equipment will be the responsibility of the person who has determined its compatibility with the product. This person should also continuously review all specifications of the product referring to its latest catalog information, with a view to giving due consideration to any possibility of equipment failure when configuring the equipment.

#### 2. Only personnel with appropriate training should operate machinery and equipment.

The product specified here may become unsafe if handled incorrectly. The assembly, operation and maintenance of machines or equipment including our products must be performed by an operator who is appropriately trained and experienced.

#### 3. Do not service or attempt to remove product and machinery/equipment until safety is confirmed.

1. The inspection and maintenance of machinery/equipment should only be performed after measures to prevent falling or runaway of the driven objects have been confirmed.
2. When the product is to be removed, confirm that the safety measures as mentioned above are implemented and the power from any appropriate source is cut, and read and understand the specific product precautions of all relevant products carefully.
3. Before machinery/equipment is restarted, take measures to prevent unexpected operation and malfunction.

#### 4. Contact SMC beforehand and take special consideration of safety measures if the product is to be used in any of the following conditions.

1. Conditions and environments outside of the given specifications, or use outdoors or in a place exposed to direct sunlight.
2. Installation on equipment in conjunction with atomic energy, railways, air navigation, space, shipping, vehicles, military, medical treatment, combustion and recreation, or equipment in contact with food and beverages, emergency stop circuits, clutch and brake circuits in press applications, safety equipment or other applications unsuitable for the standard specifications described in the product catalog.
3. An application which could have negative effects on people, property, or animals requiring special safety analysis.
4. Use in an interlock circuit, which requires the provision of double interlock for possible failure by using a mechanical protective function, and periodical checks to confirm proper operation.

### Caution

#### 1. The product is provided for use in manufacturing industries.

The product herein described is basically provided for peaceful use in manufacturing industries.  
If considering using the product in other industries, consult SMC beforehand and exchange specifications or a contract if necessary.  
If anything is unclear, contact your nearest sales branch.

### Limited warranty and Disclaimer/ Compliance Requirements

The product used is subject to the following “Limited warranty and Disclaimer” and “Compliance Requirements”.

Read and accept them before using the product.

#### Limited warranty and Disclaimer

1. The warranty period of the product is 1 year in service or 1.5 years after the product is delivered, whichever is first.\*2)  
Also, the product may have specified durability, running distance or replacement parts. Please consult your nearest sales branch.
2. For any failure or damage reported within the warranty period which is clearly our responsibility, a replacement product or necessary parts will be provided.  
This limited warranty applies only to our product independently, and not to any other damage incurred due to the failure of the product.
3. Prior to using SMC products, please read and understand the warranty terms and disclaimers noted in the specified catalog for the particular products.

##### \*2) Vacuum pads are excluded from this 1 year warranty.

A vacuum pad is a consumable part, so it is warranted for a year after it is delivered.  
Also, even within the warranty period, the wear of a product due to the use of the vacuum pad or failure due to the deterioration of rubber material are not covered by the limited warranty.

#### Compliance Requirements

1. The use of SMC products with production equipment for the manufacture of weapons of mass destruction (WMD) or any other weapon is strictly prohibited.
2. The exports of SMC products or technology from one country to another are governed by the relevant security laws and regulations of the countries involved in the transaction. Prior to the shipment of a SMC product to another country, assure that all local rules governing that export are known and followed.

### Caution

#### SMC products are not intended for use as instruments for legal metrology.

Measurement instruments that SMC manufactures or sells have not been qualified by type approval tests relevant to the metrology (measurement) laws of each country. Therefore, SMC products cannot be used for business or certification ordained by the metrology (measurement) laws of each country.

## Safety Instructions

Be sure to read the “Handling Precautions for SMC Products” (M-E03-3) and “Operation Manual” before use.

## SMC Corporation

Akihabara UDX 15F,  
4-14-1, Sotokanda, Chiyoda-ku, Tokyo 101-0021, JAPAN  
Phone: 03-5207-8249 Fax: 03-5298-5362  
<https://www.smcworld.com>  
© 2021 SMC Corporation All Rights Reserved

Specifications are subject to change without prior notice and any obligation on the part of the manufacturer.

D-G