

Longer Life Cylinder

New technology offers at least 4 times better durability

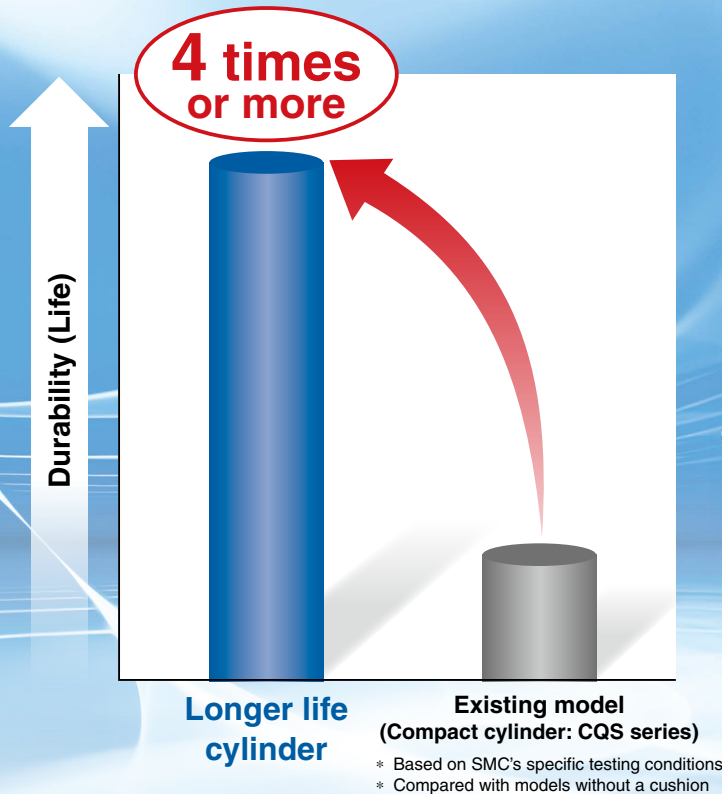

- The maintenance intervals will be extended



- Employs the same specification and dimensions as the existing models, CQS Compact Cylinder series

High Durability Series

High Durability Series is the series name for the "special specification" that offers superior durability and environmental resistance compared to standard products.

Series Variations

Series	Action	Model	Bore size [mm]				Cushion	Standard stroke [mm]
			12	16	20	25		
Compact cylinder CQS series	Double acting, Single rod	CQS-XB24	•	•	•	•	None, Rubber bumper	ø12, ø16: 5 to 30 ø20, ø25: 5 to 50
								

CQS-XB24

High Durability Series

Longer Life Cylinder Double Acting, Single Rod

CQS-XB24

ø12, ø16, ø20, ø25



How to Order

Without auto switch CQS **B** **20** - **30** **D** **□** - **XB24**

With auto switch CDQS **B** **20** - **30** **D** **□** - **M9BW** **□** - **XB24**

With auto switch (Built-in magnet)

Mounting

B	Through-hole/Both ends tapped common (Standard)
L	Foot bracket
LC	Compact foot bracket
F	Rod flange
G	Head flange
D	Double clevis

* Mounting brackets are shipped together with the product but do not come assembled.

Bore size

12	12 mm
16	16 mm
20	20 mm
25	25 mm

Cylinder stroke [mm]

Bore size	Standard stroke
12, 16	5, 10, 15, 20, 25, 30
20	5, 10, 15, 20, 25, 30, 35, 40, 45, 50
25	30, 35, 40, 45, 50

Number of auto switches

Nil	2
S	1
n	n

Auto switch

Nil	Without auto switch
------------	---------------------

* For applicable auto switches, refer to the table below.

Body option

Nil	Standard
C	With rubber bumper
M	Rod end male thread

* Combination of body options is available.
CM

Action

D	Double acting
----------	---------------

Built-in Magnet Cylinder Model

If a built-in magnet cylinder without an auto switch is required, there is no need to enter the symbol for the auto switch.
(Example) CDQSL25-30D-XB24

Applicable Auto Switches / Refer to the Web Catalog for further information on auto switches.

Type	Special function	Electrical entry	Indicator light	Wiring (Output)	Load voltage		Auto switch model		Lead wire length [m]				Pre-wired connector	Applicable load							
					DC	AC	Perpendicular	In-line	0.5 (Nil)	1 (M)	3 (L)	5 (Z)									
Solid state auto switch	—	Grommet	Yes	3-wire (NPN)	5 V, 12 V	—	M9NV	M9N	●	●	●	○	○	IC circuit	Relay, PLC						
				3-wire (PNP)					●	●	●	○									
				2-wire	12 V				●	●	●	○									
				3-wire (NPN)	5 V, 12 V				●	●	●	○									
	3-wire (PNP)			●					●	●	○										
	Diagnostic indication (2-color indicator)			2-wire	12 V				●	●	●	○									
				3-wire (NPN)	5 V, 12 V				○	○	●	○									
	Water resistant (2-color indicator)			3-wire (PNP)					○	○	●	○									
				2-wire	12 V				○	○	●	○									
	Magnetic field resistant (2-color indicator)			3-wire (NPN)	5 V, 12 V				○	○	●	○									
3-wire (PNP)		○	○	●		○															
Reed auto switch	—	Grommet	Yes	3-wire (NPN equivalent)	—	—	A96V	A96	●	—	●	—	—	IC circuit	—						
				2-wire					24 V	12 V	●	●				●	●				
				—	100 V				100 V or less	A93V*2	A93	●				●	●	●	—	—	Relay, PLC
									100 V or less	A90V	A90	●				—	●	—	—	—	IC circuit

*1 Water-resistant type auto switches can be mounted on the models, but SMC cannot guarantee water resistance.

Please contact SMC regarding water-resistant types with the above model numbers.

*2 The 1 m lead wire is only applicable to the D-A93.

* Lead wire length symbols: 0.5 m..... Nil (Example) M9NW
1 m..... M (Example) M9NWM
3 m..... L (Example) M9NWL
5 m..... Z (Example) M9NWX

* Solid state auto switches marked with a "○" are produced upon receipt of order.

** Available only for ø25.

It is mounted away from the port side to avoid interference with fittings.

* Since there are applicable auto switches other than those listed above, refer to the Web Catalog for details.

* The installation of auto switches is equivalent to that for the CQS Compact Cylinder series. For details, refer to the Web Catalog.

Specifications



Bore size [mm]	12	16	20	25	
Action	Double acting, Single rod				
Fluid	Air				
Lubrication	Not required (Non-lube)				
Proof pressure	1.5 MPa				
Max. operating pressure	1.0 MPa				
Min. operating pressure	0.07 MPa	0.05 MPa			
Ambient and fluid temperatures	Without auto switch: -10 to 70°C (No freezing)				
	With auto switch: -10 to 60°C (No freezing)				
Cushion	None, Rubber bumper				
Stroke length tolerance	+1.0 *1 0				
Piston speed	50 to 500 mm/s				
Allowable kinetic energy [J]	Without cushion	0.022	0.038	0.055	0.09
	With rubber bumper	0.043	0.075	0.11	0.18

*1 Stroke length tolerance does not include the deflection of the bumper.

Symbol

Without cushion

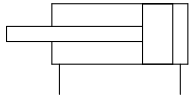

Rubber bumper

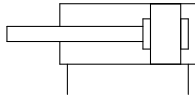

Made to Order

For details, refer to the **Web Catalog**.

Symbol	Specifications
-XA□	Change of rod end shape

* Only applicable to the -XA6, 7, 17, and 18

Mounting Bracket Part Nos.

Bore size [mm]	Foot bracket*1	Compact foot bracket*1	Flange	Double clevis
12	CQS-L012	CQS-LC012	CQS-F012	CQS-D012
16	CQS-L016	CQS-LC016	CQS-F016	CQS-D016
20	CQS-L020	CQS-LC020	CQS-F020	CQS-D020
25	CQS-L025	CQS-LC025	CQS-F025	CQS-D025

*1 When ordering foot and compact foot brackets, order 2 pieces per cylinder.

* Parts included with each type of bracket are as follows.

Foot bracket, Compact foot bracket, Flange: Body mounting bolts

Double clevis: Clevis pin, Type C retaining rings for axis, Body mounting bolts

The mounting pitch and shape of this product with auto switch are the same as those of the Compact Cylinder CQS series with auto switch. For details, refer to the **Web Catalog**.

- Auto Switch Proper Mounting Position (Detection at stroke end) and Mounting Height
- Min. Stroke for Auto Switch Mounting
- Operating Range
- Auto Switch Mounting Brackets/Part Nos.

Moisture Control Tube IDK Series



When operating an actuator with a small bore size and a short stroke at a high frequency, dew condensation (water droplets) may occur inside the piping depending on the conditions. Simply connecting the moisture control tube to the actuator will prevent dew condensation from occurring. For details, refer to the **Web Catalog**.

The allowable kinetic energy, allowable loads at the rod end, theoretical output, weight, accessory, and mounting bolts for a through hole are equivalent to those of the Compact Cylinder CQS series. For details, refer to the Web Catalog.

CQS-XB24

Dimensions: $\varnothing 12$ to $\varnothing 25$

Standard (Through-hole/Both ends tapped common): CQSB/CDQSB-XB24

$\varnothing 12$

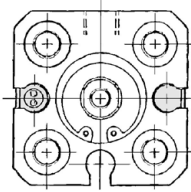

$\varnothing 16$

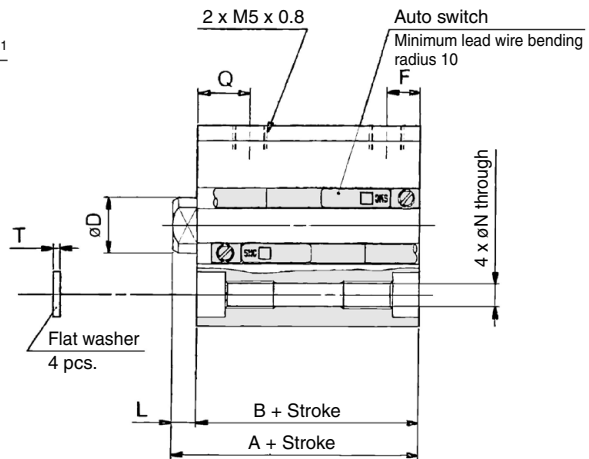
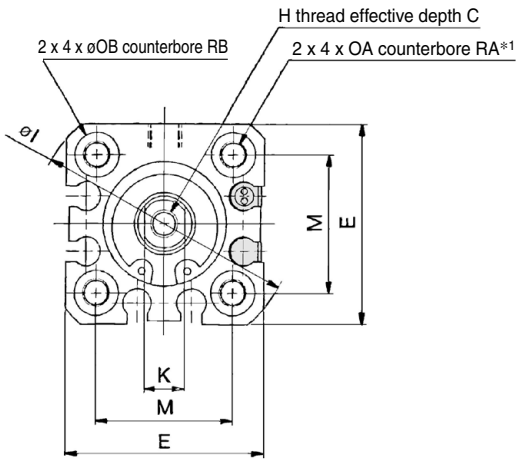

$\varnothing 20, \varnothing 25$

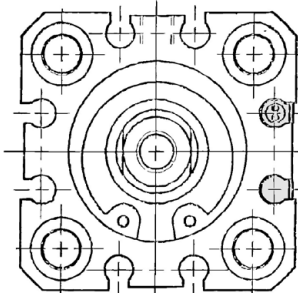

Rod end male thread

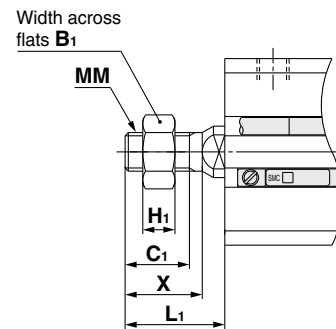

Rod End Male Thread [mm]

Bore size	B ₁	C ₁	H ₁	L ₁	MM	X
12	8	9	4	14	M5 x 0.8	10.5
16	10	10	5	15.5	M6 x 1.0	12
20	13	12	5	18.5	M8 x 1.25	14
25	17	15	6	22.5	M10 x 1.25	17.5

Standard

Bore size	Standard stroke range	Standard stroke								C	D	E	H	I	K	M	N	OA	OB	Q	RA	RB	T
		Without auto switch				With auto switch																	
		A	B	F	L	A	B	F	L														
12	5 to 30	20.5	17	5	3.5	25.5	22	5	3.5	6	6	25	M3 x 0.5	32	5	15.5	3.5	M4 x 0.7	6.5	7.5	7	4	0.5
16	5 to 30	20.5	17	5	3.5	25.5	22	5	3.5	8	8	29	M4 x 0.7	38	6	20	3.5	M4 x 0.7	6.5	7.5	7	4	0.5
20	5 to 50	24	19.5	5.5	4.5	34	29.5	5.5	4.5	7	10	36	M5 x 0.8	47	8	25.5	5.4	M6 x 1.0	9	8	10	7	1
25	5 to 50	27.5	22.5	5.5	5	37.5	32.5	5.5	5	12	12	40	M6 x 1.0	52	10	28	5.4	M6 x 1.0	9	9	10	7	1

*1 For the following bore/stroke sizes through-hole is threaded over the entire length: Standard $\varnothing 12$ and $\varnothing 16$; 5 stroke, $\varnothing 20$; 5 to 15 stroke, $\varnothing 25$; 5 to 10 stroke, $\varnothing 20$ with auto switch built-in magnet; 5 stroke.

Dimensions: $\varnothing 12$ to $\varnothing 25$

Foot bracket: CQSL/CDQSL-XB24

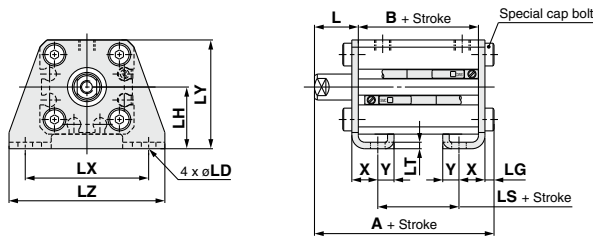

Rod end male thread

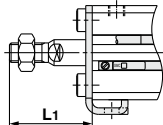

Foot Bracket

Bore size	Standard stroke range	Without auto switch			With auto switch		
		A	B	LS	A	B	LS
12	5 to 30	35.3	17	5	40.3	22	10
16	5 to 30	35.3	17	5	40.3	22	10
20	5 to 50	41.2	19.5	7.5	51.2	29.5	17.5
25	5 to 50	44.7	22.5	7.5	54.7	32.5	17.5

Bore size	L	L1	LD	LG	LH	LT	LX	LY	LZ	X	Y
12	13.5	24	4.5	2.8	17	2	34	29.5	44	8	4.5
16	13.5	25.5	4.5	2.8	19	2	38	33.5	48	8	5
20	14.5	28.5	6.6	4	24	3.2	48	42	62	9.2	5.8
25	15	32.5	6.6	4	26	3.2	52	46	66	10.7	5.8

Compact foot bracket: CQSLC/CDQSLC-XB24

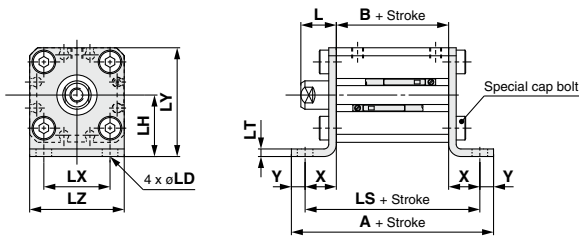

Rod end male thread

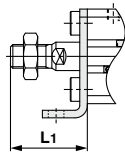

Compact Foot Bracket

Bore size	Standard stroke range	Without auto switch			With auto switch		
		A	B	LS	A	B	LS
12	5 to 30	44.6	17	35.6	49.6	22	40.6
16	5 to 30	45.6	17	35.6	50.6	22	40.6
20	5 to 50	57.5	19.5	45.9	67.5	29.5	55.9
25	5 to 50	60.5	22.5	48.9	70.5	32.5	58.9

Bore size	L	L1	LD	LH	LT	LX	LY	LZ	X	Y
12	13.5	24	4.5	17	2	15.5	29.5	25	9.3	4.5
16	13.5	25.5	4.5	19	2	20	33.5	29	9.3	5
20	14.5	28.5	6.6	24	3.2	25.5	42	36	13.2	5.8
25	15	32.5	6.6	26	3.2	28	46	40	13.2	5.8

Rod flange: CQSF/CDQSF-XB24

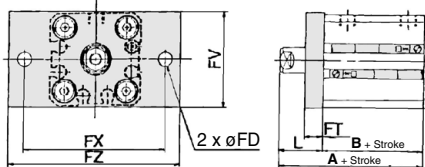

Rod end male thread

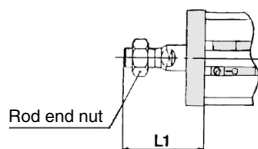

Rod Flange

Bore size	Standard stroke range	Without auto switch		With auto switch	
		A	B	A	B
12	5 to 30	30.5	17	35.5	22
16	5 to 30	30.5	17	35.5	22
20	5 to 50	34	19.5	44	29.5
25	5 to 50	37.5	22.5	47.5	32.5

Bore size	FD	FT	FV	FX	FZ	L	L1
12	4.5	5.5	25	45	55	13.5	24
16	4.5	5.5	30	45	55	13.5	25.5
20	6.6	8	39	48	60	14.5	28.5
25	6.6	8	42	52	64	15	32.5

Head flange: CQSG/CDQSG-XB24

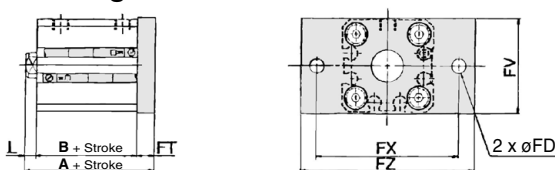

Rod end male thread

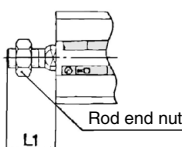

Head Flange

Bore size	Standard stroke range	Without auto switch				With auto switch			
		A	B	L	L1	A	B	L	L1
12	5 to 30	26	17	3.5	14	31	22	3.5	14
16	5 to 30	26	17	3.5	15.5	31	22	3.5	15.5
20	5 to 50	32	19.5	4.5	18.5	42	29.5	4.5	18.5
25	5 to 50	35.5	22.5	5	22.5	45.5	32.5	5	22.5

Bore size	FD	FT	FV	FX	FZ
12	4.5	5.5	25	45	55
16	4.5	5.5	30	45	55
20	6.6	8	39	48	60
25	6.6	8	42	52	64

CQS-XB24

Dimensions: $\varnothing 12$ to $\varnothing 25$

Double clevis: CQSD/CDQSD-XB24

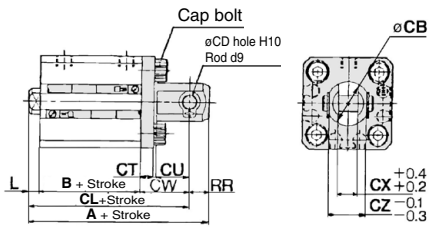

Rod end male thread

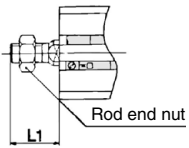

Double Clevis

[mm]

Bore size	Standard stroke range	Without auto switch					With auto switch				
		A	B	CL	L	L ₁	A	B	CL	L	L ₁
12	5 to 30	40.5	17	34.5	3.5	14	45.5	22	39.5	3.5	14
16	5 to 30	41.5	17	35.5	3.5	15.5	46.5	22	40.5	3.5	15.5
20	5 to 50	51	19.5	42	4.5	18.5	61	29.5	52	4.5	18.5
25	5 to 50	57.5	22.5	47.5	5	22.5	67.5	32.5	57.5	5	22.5

Bore size	CB	CD	CT	CU	CW	CX	CZ	RR
12	12	5	4	7	14	5	10	6
16	14	5	4	10	15	6.5	12	6
20	20	8	5	12	18	8	16	9
25	24	10	5	14	20	10	20	10

Specific Product Precautions



Be sure to read this before handling the products. Refer to the back cover for safety instructions. For actuator and auto switch precautions, refer to the “Handling Precautions for SMC Products,” the “Operation Manual,” and compact cylinder CQS series specific product precautions on the SMC website: <https://www.smcworld.com>

Mounting

Caution

This cylinder is designed to create compact mechanical equipment and promote space saving. Thus, if it is used in the same manner as existing cylinders such as tie-rod cylinders, it may degrade the performance. Pay sufficient attention to the operating conditions when using.

1. Allowable lateral load

Lateral load that can apply to the piston rod end is limited. If a cylinder is used with a lateral load over the limit, it may cause air leakage due to abnormal friction of seals, galling of cylinder tubes and pistons, or abnormal friction of the bearing part. The lateral load applied to the piston rod must be within the allowable range indicated in this catalog. When the load exceeds the limit, install a guide or change the bore size to suit the load in order to make the load within the allowable range.

2. Connection with a workpiece

When a workpiece is mounted on the piston rod end, connect them aligning the center of piston rod and a workpiece. If they are off-center, lateral load is generated and phenomena mentioned in 1. may occur. In order not to apply the off-center load, use of a floating joint or simple joint is recommended.

3. Simultaneous use of multiple cylinders

It is difficult to control the speed of pneumatic cylinders. The following conditions cause speed change: change in supply pressure, load, temperature and lubrication, performance difference of each cylinder, deterioration of each part over time, etc. A speed controller can be used to control the speed of multiple cylinders simultaneously for a short period of time, but depending on conditions, it may not work as desired. If multiple cylinders cannot operate simultaneously, unreasonable force is applied to the piston rod because cylinder positions may not be the same. This may cause abnormal friction of seals and bearings, and galling of cylinder tubes and pistons. Do not use an application to operate several cylinders simultaneously by adjusting cylinder speed. If this is inevitable, use a high rigid guide against load, so that the cylinder is not damaged even when the each cylinder output is slightly different.

Durability of The Cylinder

The durability of a longer life cylinder has been evaluated by comparison with the existing cylinders under SMC’s test conditions.

The durability of a cylinder depends on the customer’s operating conditions and operating environment. Therefore, durability of four times or longer will not be guaranteed under all conditions.

Safety Instructions

These safety instructions are intended to prevent hazardous situations and/or equipment damage. These instructions indicate the level of potential hazard with the labels of “**Caution**,” “**Warning**” or “**Danger**.” They are all important notes for safety and must be followed in addition to International Standards (ISO/IEC)*1), and other safety regulations.

 **Caution:** **Caution** indicates a hazard with a low level of risk which, if not avoided, could result in minor or moderate injury.

 **Warning:** **Warning** indicates a hazard with a medium level of risk which, if not avoided, could result in death or serious injury.

 **Danger :** **Danger** indicates a hazard with a high level of risk which, if not avoided, will result in death or serious injury.

*1) ISO 4414: Pneumatic fluid power – General rules relating to systems.
ISO 4413: Hydraulic fluid power – General rules relating to systems.
IEC 60204-1: Safety of machinery – Electrical equipment of machines.
(Part 1: General requirements)
ISO 10218-1: Manipulating industrial robots – Safety.
etc.

Warning

1. The compatibility of the product is the responsibility of the person who designs the equipment or decides its specifications.

Since the product specified here is used under various operating conditions, its compatibility with specific equipment must be decided by the person who designs the equipment or decides its specifications based on necessary analysis and test results. The expected performance and safety assurance of the equipment will be the responsibility of the person who has determined its compatibility with the product. This person should also continuously review all specifications of the product referring to its latest catalog information, with a view to giving due consideration to any possibility of equipment failure when configuring the equipment.

2. Only personnel with appropriate training should operate machinery and equipment.

The product specified here may become unsafe if handled incorrectly. The assembly, operation and maintenance of machines or equipment including our products must be performed by an operator who is appropriately trained and experienced.

3. Do not service or attempt to remove product and machinery/equipment until safety is confirmed.

1. The inspection and maintenance of machinery/equipment should only be performed after measures to prevent falling or runaway of the driven objects have been confirmed.
2. When the product is to be removed, confirm that the safety measures as mentioned above are implemented and the power from any appropriate source is cut, and read and understand the specific product precautions of all relevant products carefully.
3. Before machinery/equipment is restarted, take measures to prevent unexpected operation and malfunction.

4. Contact SMC beforehand and take special consideration of safety measures if the product is to be used in any of the following conditions.

1. Conditions and environments outside of the given specifications, or use outdoors or in a place exposed to direct sunlight.
2. Installation on equipment in conjunction with atomic energy, railways, air navigation, space, shipping, vehicles, military, medical treatment, combustion and recreation, or equipment in contact with food and beverages, emergency stop circuits, clutch and brake circuits in press applications, safety equipment or other applications unsuitable for the standard specifications described in the product catalog.
3. An application which could have negative effects on people, property, or animals requiring special safety analysis.
4. Use in an interlock circuit, which requires the provision of double interlock for possible failure by using a mechanical protective function, and periodical checks to confirm proper operation.

Caution

1. The product is provided for use in manufacturing industries.

The product herein described is basically provided for peaceful use in manufacturing industries.
If considering using the product in other industries, consult SMC beforehand and exchange specifications or a contract if necessary.
If anything is unclear, contact your nearest sales branch.

Limited warranty and Disclaimer/ Compliance Requirements

The product used is subject to the following “Limited warranty and Disclaimer” and “Compliance Requirements”.

Read and accept them before using the product.

Limited warranty and Disclaimer

1. The warranty period of the product is 1 year in service or 1.5 years after the product is delivered, whichever is first.*2)
Also, the product may have specified durability, running distance or replacement parts. Please consult your nearest sales branch.
2. For any failure or damage reported within the warranty period which is clearly our responsibility, a replacement product or necessary parts will be provided.
This limited warranty applies only to our product independently, and not to any other damage incurred due to the failure of the product.
3. Prior to using SMC products, please read and understand the warranty terms and disclaimers noted in the specified catalog for the particular products.

*2) Vacuum pads are excluded from this 1 year warranty.

A vacuum pad is a consumable part, so it is warranted for a year after it is delivered.
Also, even within the warranty period, the wear of a product due to the use of the vacuum pad or failure due to the deterioration of rubber material are not covered by the limited warranty.

Compliance Requirements

1. The use of SMC products with production equipment for the manufacture of weapons of mass destruction (WMD) or any other weapon is strictly prohibited.
2. The exports of SMC products or technology from one country to another are governed by the relevant security laws and regulations of the countries involved in the transaction. Prior to the shipment of a SMC product to another country, assure that all local rules governing that export are known and followed.

Caution

SMC products are not intended for use as instruments for legal metrology.

Measurement instruments that SMC manufactures or sells have not been qualified by type approval tests relevant to the metrology (measurement) laws of each country. Therefore, SMC products cannot be used for business or certification ordained by the metrology (measurement) laws of each country.

Safety Instructions

Be sure to read the “Handling Precautions for SMC Products” (M-E03-3) and “Operation Manual” before use.

SMC Corporation

Akihabara UDX 15F,
4-14-1, Sotokanda, Chiyoda-ku, Tokyo 101-0021, JAPAN
Phone: 03-5207-8249 Fax: 03-5298-5362
<https://www.smcworld.com>
© 2023 SMC Corporation All Rights Reserved

Specifications are subject to change without prior notice and any obligation on the part of the manufacturer.

D-G