

Electric Actuator

High Performance Slide Table/ High Precision Type

New
CE UK
CA

* For details, refer to page 47 and onward.

Battery-less Absolute (Step Motor 24 VDC)

RoHS

Reduces cycle time

Cycle time

Reduced by **39%** (0.37 s ← 0.61 s)
compared with the existing model*¹

*¹ When LESYH25DGA-150 is operated from 0 to 150 mm

Acceleration/
Deceleration

10000 mm/s²
(200% increase compared with the existing model)

Max. speed

800 mm/s
(Improved by 200% compared with the existing model)

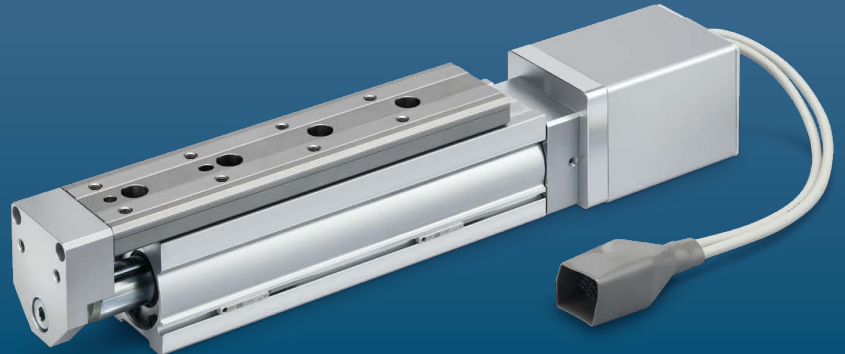
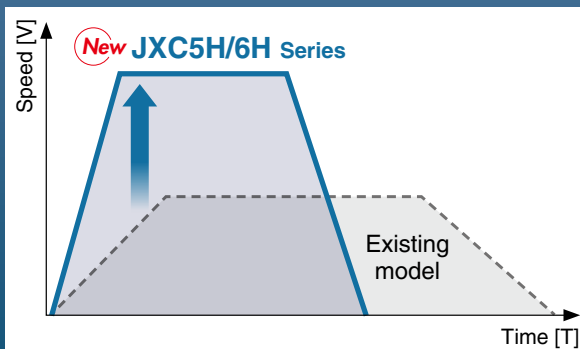

Improved positioning repeatability due to the adoption of a ball screw drive.

Positioning repeatability **±0.01 mm**

Lost motion **0.1 mm or less**

Battery-less absolute encoder compatible

High Performance
Step Motor Controller

Higher acceleration and max. speed can be set with the special controller.

Parallel I/O

JXC5H/6H Series p. 33



EtherCAT/EtherNet/IP™/
PROFINET

JXCEH/9H/PH Series p. 40



LESYH□G Series

SMC

CAT.ES100-149A

Battery-less Absolute Encoder Type Restart from the last stop position is possible after recovery of the power supply.

The position information is held by the encoder even when the power supply is turned off. A return to origin operation is not necessary when the power supply is recovered.

Auto switches are mountable.

Mounting groove for auto switches

For checking the limit and the intermediate signal
Applicable to the D-M9□, D-M9□E, and D-M9□W (2-color indicator)

* The auto switches should be ordered separately. For details, refer to pages 25 to 27.

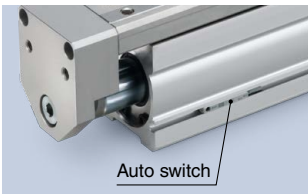

2-color indicator solid state auto switch

Accurate setting of the mounting position can be performed without mistakes.

A **green** light lights up when within the optimum operating range.

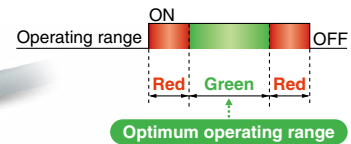

Maintenance labor can be reduced as the product does not require the use of batteries.

Batteries are not required to store the position information. Therefore, there is no need to store spare batteries or to recycle and replace dead batteries.



Does not contain a battery

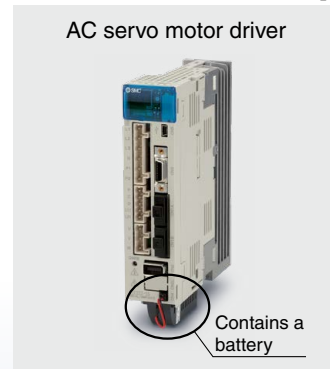

Contains a battery

Motor mounting position

Select from 3 directions

In-line

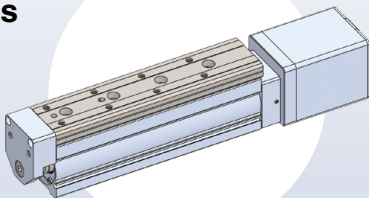

Right side parallel

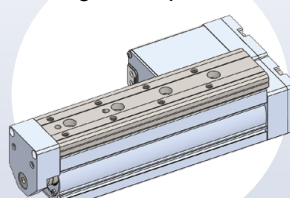

Left side parallel

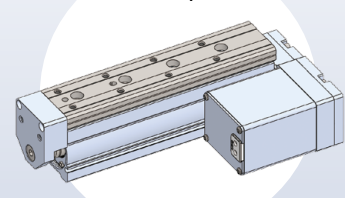

Application examples

• For pick and place operations

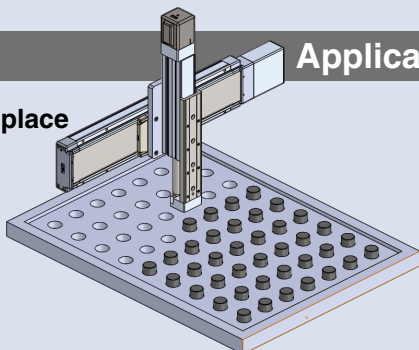

• For vertical transfer (Z axis)

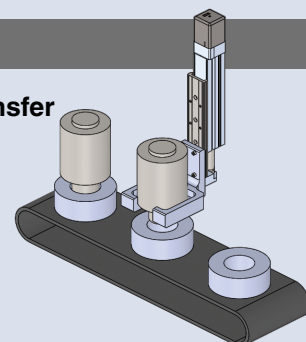



Step Data Input Type JXC5H/6H Series p.33

ACT 2 Controller Setting Software ACT Controller 2

Easy-to-use setting software ACT Controller 2 (For PC)

Various functions available in normal mode (Compared with the existing ACT Controller)

● Parameter and step data setting

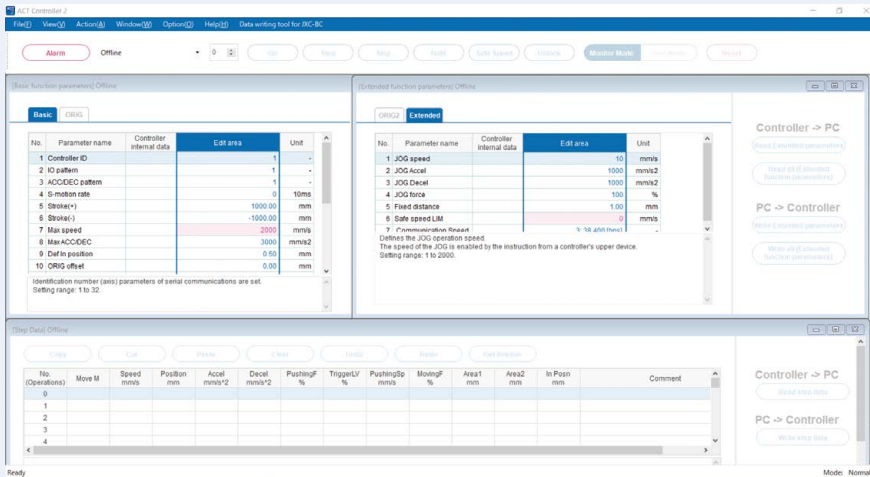

* Customers operating computers with specifications other than Windows 10/64 bit should use the existing ACT Controller.

● Alarm confirmation

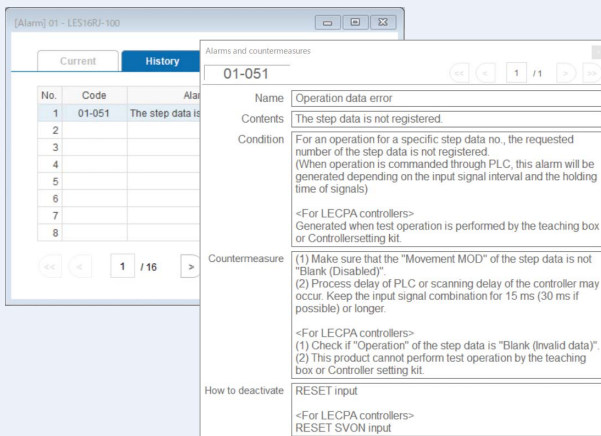

When an alarm is generated, the alarm details and countermeasures can be confirmed.

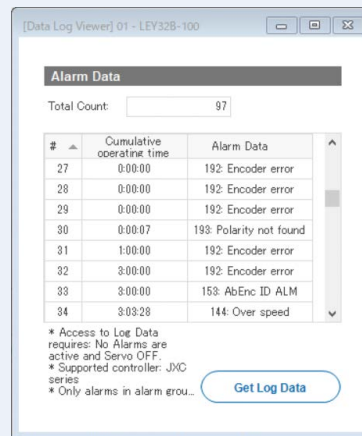

When an alarm is generated, the cumulative start-up time of the controller can be confirmed.

● Waveform monitoring

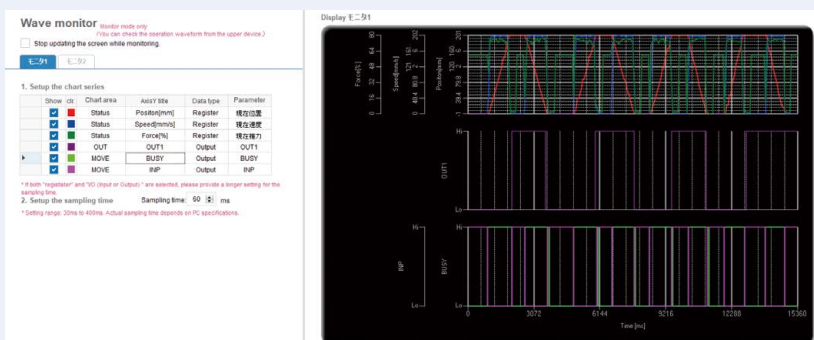

The position, speed, force, and input/output signals' waveform data during operation can be measured.

* When using the ACT Controller 2 test operation function, waveform monitoring is not available.



ACT 2

Controller Setting Software ACT Controller 2

• **The JXC-BC writing tool**

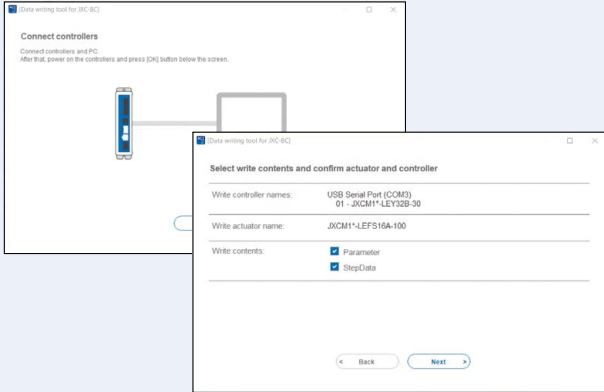

The writing tool can be used to write the connected actuator's parameters and step data to a JXC series blank controller.

• **Customizable plug-in functions**

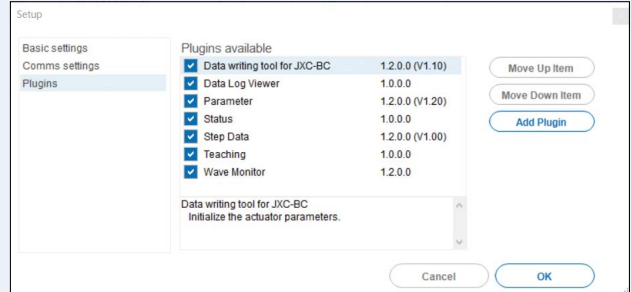

Which plug-in functions are displayed as well as the display order are customizable. Customers can add the functions they require.

In normal mode, various other test operation methods (program operation, jogging, moving of the constant rate, etc.), signal status monitoring, one-touch switching between Japanese and English, and other functions are available.

For immediate use, operate in easy mode.

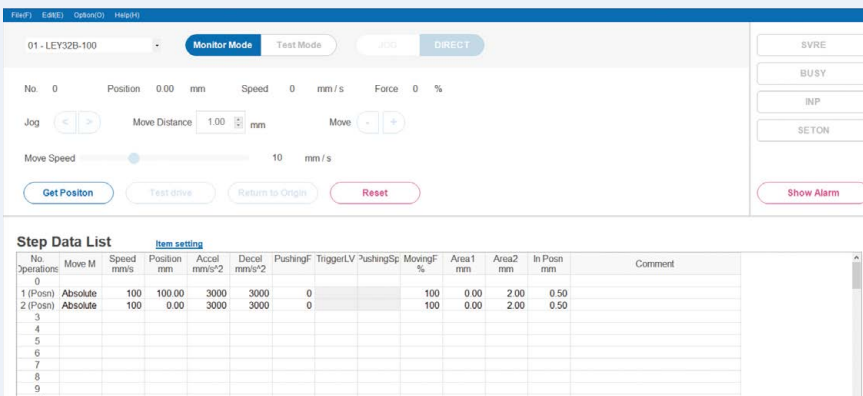

Step data setting, various test operations, and status confirmation can be done on a single screen.

How to download the setting software

[Click here for details.](#)

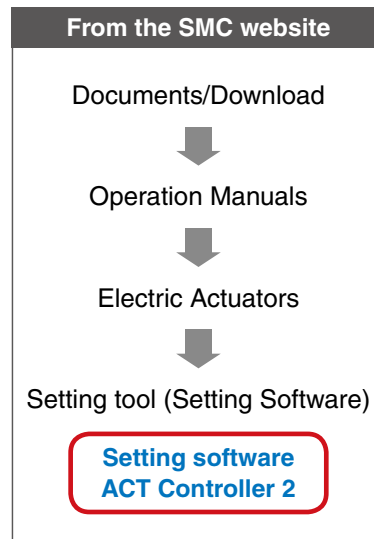
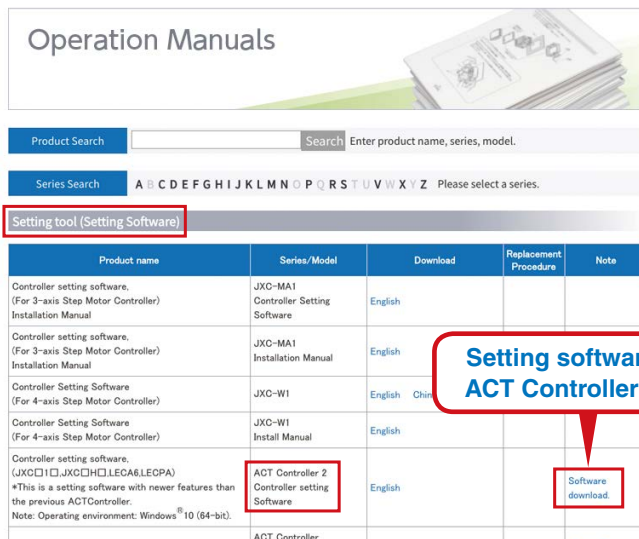

Step Data Input Type JXC5H/6H Series



Teaching Box

Normal Mode

- Multiple step data can be stored in the teaching box and transferred to the controller.
- Continuous test drive by up to 5 step data

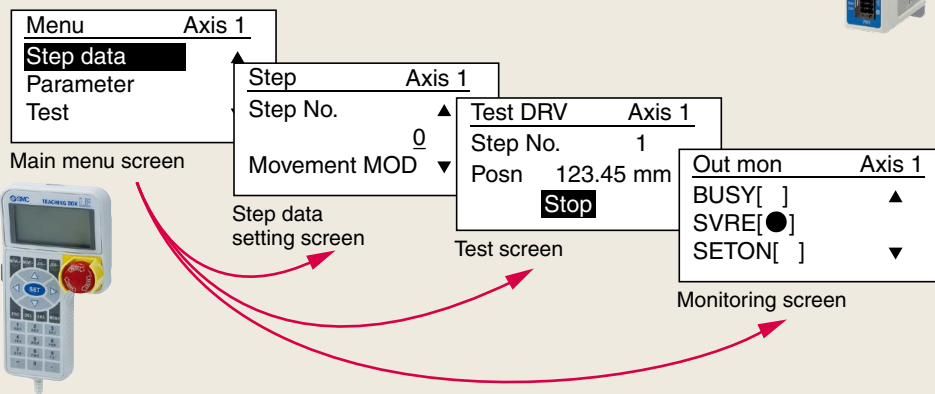

Teaching box screen

- Each function (step data setting, test drive, monitoring, etc.) can be selected from the main menu.

Easy Mode

- The simple screen without scrolling promotes ease of setting and operation.
- Choose an icon from the first screen to select a function.
- Set the step data and check the monitor on the second screen.



Example of setting the step data

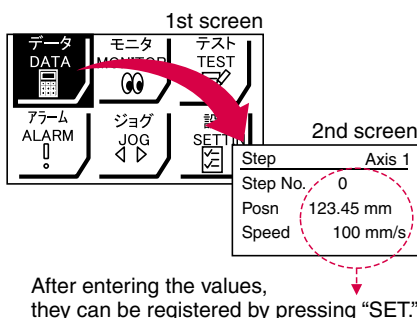

Example of checking the operation status

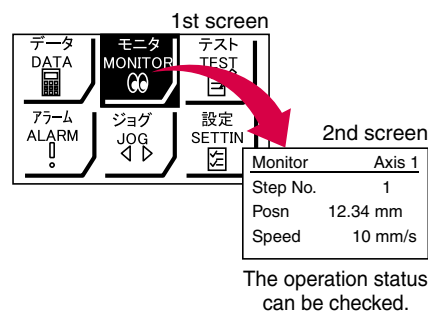

Teaching box screen

- Data can be set by inputting only the position and speed. (Other conditions are preset.)

Step	Axis 1
Step No.	0
Posn	50.00 mm
Speed	200 mm/s



Step	Axis 1
Step No.	1
Posn	80.00 mm
Speed	100 mm/s

The actuator and controller are provided as a set. (They can be ordered separately as well.)

Confirm that the combination of the controller and actuator is correct.

<Check the following before use.>

- ① Check the actuator label for the model number. This number should match that of the controller.
- ② Check that the Parallel I/O configuration matches (NPN or PNP).

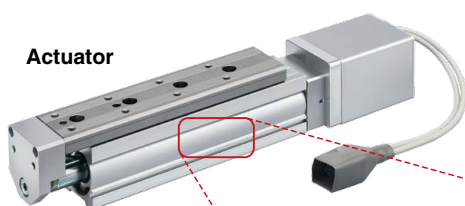

Actuator

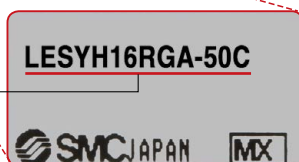

①



Controller

LESYH16RGA-50C

NPN

①

②

Function

Item	Step data input type JXC5H/6H
Step data and parameter setting	<ul style="list-style-type: none"> Input from controller setting software (PC) Input from teaching box
Step data “position” setting	<ul style="list-style-type: none"> Numerical value input from controller setting software (PC) or teaching box Input numerical value Direct teaching JOG teaching
Number of step data	64 points
Operation command (I/O signal)	Step No. [IN ⁺] input ⇒ [DRIVE] input
Completion signal	[INP] output

Setting Items

TB: Teaching box PC: Controller setting software

Item		Contents	Easy Mode		Normal Mode	Step data input type JXC5H/6H
			TB	PC	TB/PC	
Step data setting (Excerpt)	Movement MOD	Selection of “absolute position” and “relative position”	△	●	●	Set at ABS/INC
	Speed	Transfer speed	●	●	●	Set in units of 1 mm/s
	Position	[Position]: Target position [Pushing]: Pushing start position	●	●	●	Set in units of 0.01 mm
	Acceleration/Deceleration	Acceleration/deceleration during movement	●	●	●	Set in units of 1 mm/s ²
	Pushing force	Rate of force during pushing operation	●	●	●	Set in units of 1%
	Trigger LV	Target force during pushing operation	△	●	●	Set in units of 1%
	Pushing speed	Speed during pushing operation	△	●	●	Set in units of 1 mm/s
	Moving force	Force during positioning operation	△	●	●	Set to 100%
	Area output	Conditions for area output signal to turn ON	△	●	●	Set in units of 0.01 mm
	In position	[Position]: Width to the target position [Pushing]: How much it moves during pushing	△	●	●	Set to 0.5 mm or more (Units: 0.01 mm)
Parameter setting (Excerpt)	Stroke (+)	+ side position limit	×	×	●	Set in units of 0.01 mm
	Stroke (-)	- side position limit	×	×	●	Set in units of 0.01 mm
	ORIG direction	Direction of the return to origin can be set.	×	×	●	Compatible
	ORIG speed	Speed during return to origin	×	×	●	Set in units of 1 mm/s
	ORIG ACC	Acceleration during return to origin	×	×	●	Set in units of 1 mm/s ²
Test	JOG		●	●	●	Continuous operation at the set speed can be tested while the switch is being pressed.
	MOVE		×	●	●	Operation at the set distance and speed from the current position can be tested.
	Return to ORIG		●	●	●	Compatible
	Test drive	Operation of the specified step data	●	●	● (Continuous operation)	Compatible
	Forced output	ON/OFF of the output terminal can be tested.	×	×	●	Compatible
Monitor	DRV mon	Current position, speed, force, and the specified step data can be monitored.	●	●	●	Compatible
	In/Out mon	Current ON/OFF status of the input and output terminal can be monitored.	×	×	●	Compatible
ALM	Status	Alarm currently being generated can be confirmed.	●	●	●	Compatible
	ALM Log record	Alarms generated in the past can be confirmed.	×	×	●	Compatible
File	Save/Load	Step data and parameters can be saved, forwarded, and deleted.	×	×	●	Compatible
Other	Language	Can be changed to Japanese or English	●	●	●	Compatible

△: Can be set from TB Ver. 2.** (The version information is displayed on the initial screen.)

Fieldbus Network

EtherCAT/EtherNet/IP™/PROFINET

Direct Input Type

Step Motor Controller/JXC□ Series p. 40

Ether**CAT**®



Ether**Net/IP**™



PROFI®
NET



Two types of operation command

Step no. defined operation: Operate using the preset step data in the controller.

Numerical data defined operation: The actuator operates using values such as position and speed from the PLC.

Numerical monitoring available

Numerical information, such as the current speed, current position, and alarm codes, can be monitored on the PLC.

Transition wiring of communication cables

Two communication ports are provided.

PLC

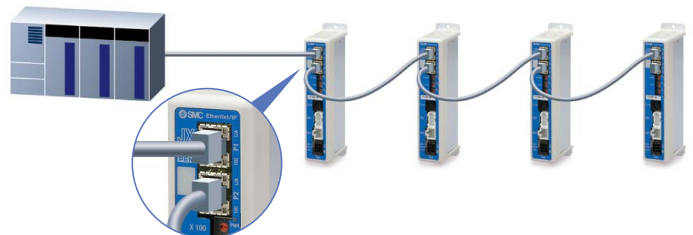

Application

Communication protocols

Ether**CAT**®

Ether**Net/IP**™

PROFI®
NET

Both air and electric systems can be established under the same protocol.

Electric Actuators

Air Cylinders

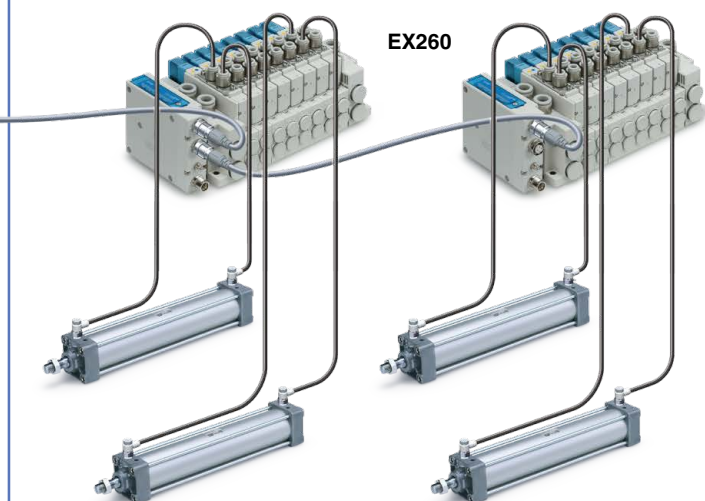
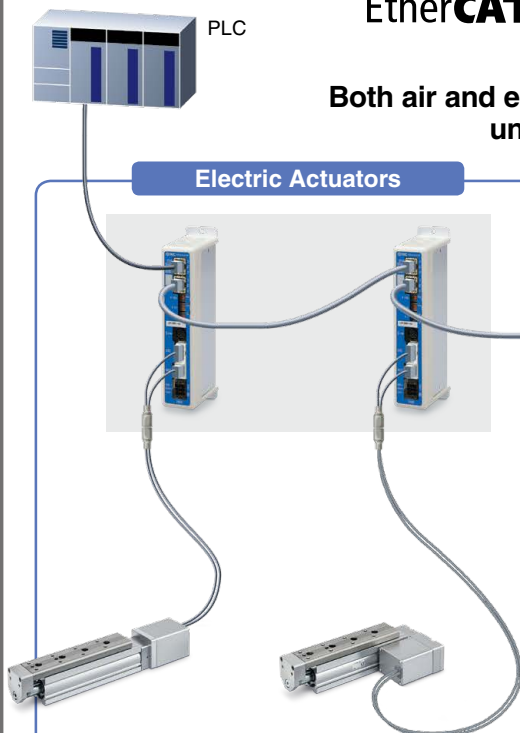

System Construction/General Purpose I/O

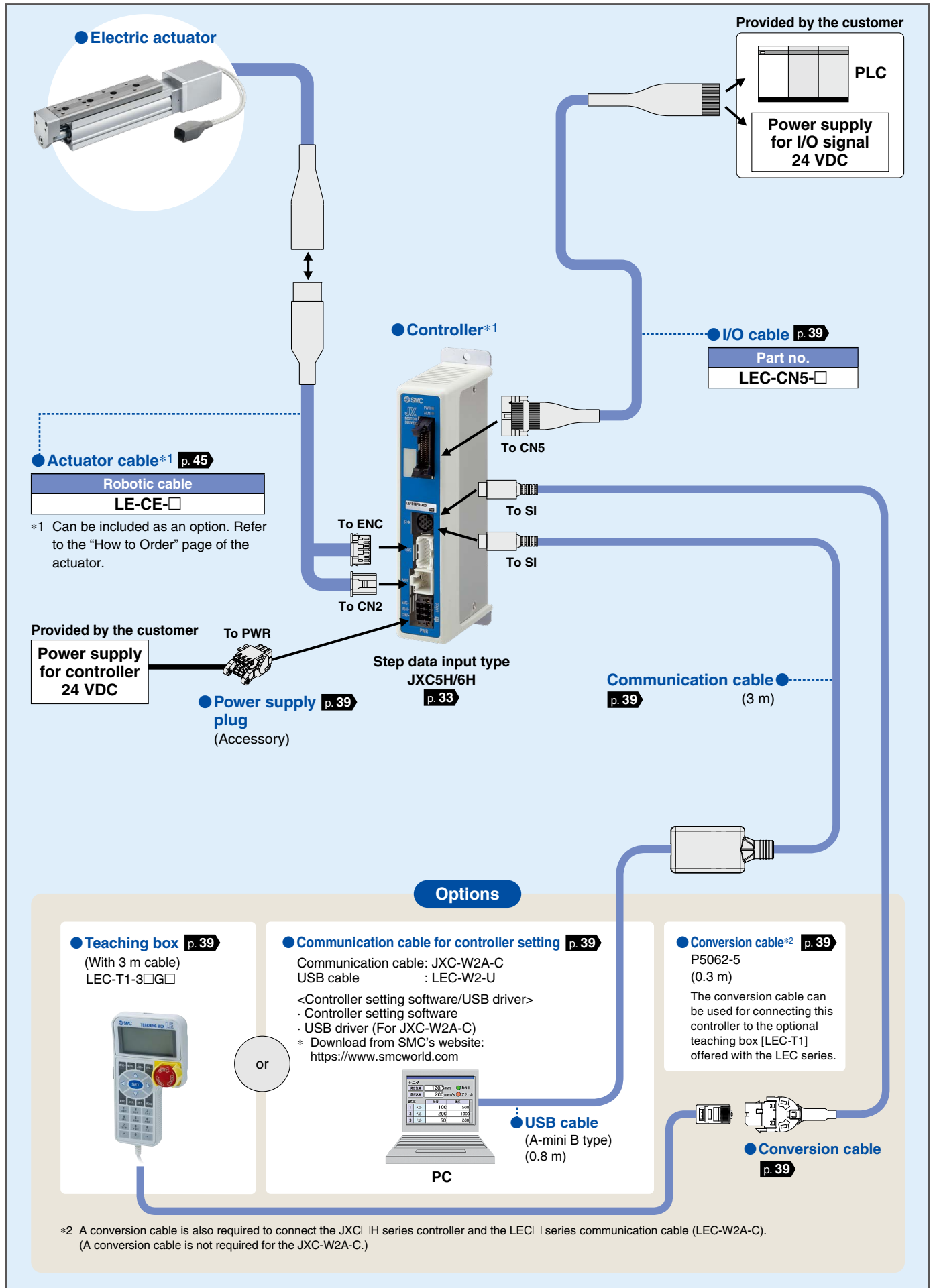

System Construction/Fieldbus Network (EtherCAT/EtherNet/IP™/PROFINET Direct Input Type)

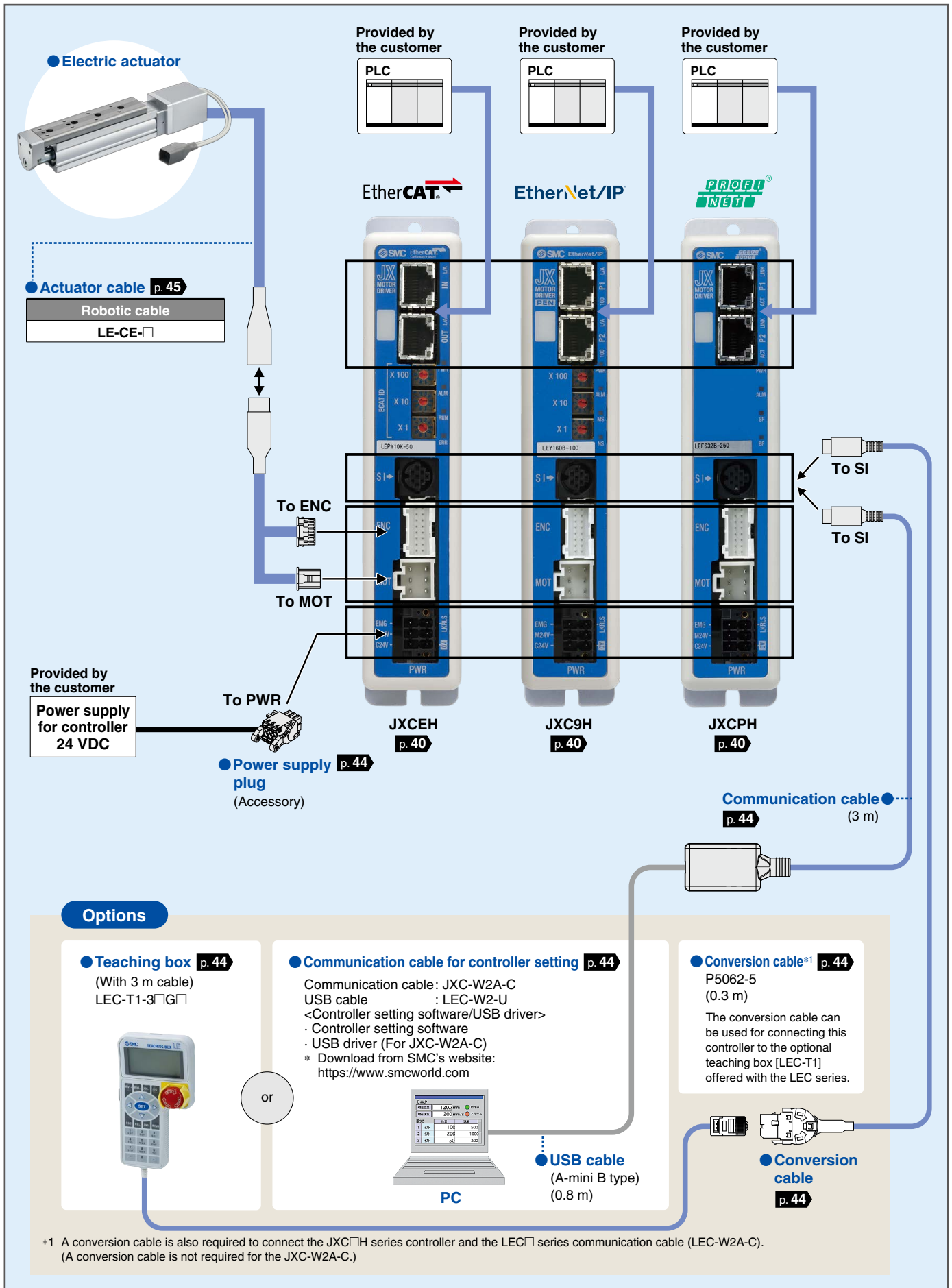

Electric Actuator

High Performance Slide Table/High Precision Type

Slide Table/High Precision Type *LESYH□G Series*

Battery-less Absolute (Step Motor 24 VDC)

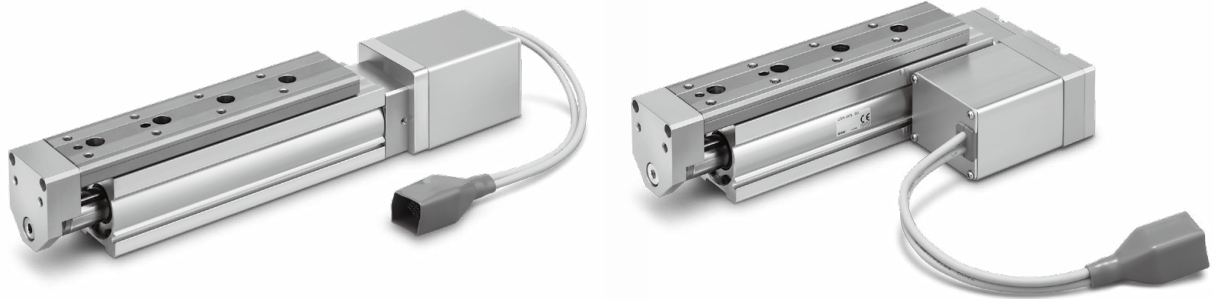

Model Selection

LESYH□G Series

CONTENTS

High Performance Slide Table/High Precision Type *LESYH□G Series* p. 8

Battery-less Absolute (Step Motor 24 VDC)

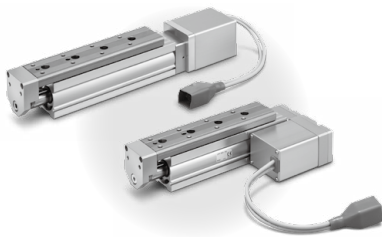

Model Selection	p. 9
How to Order	p. 17
Specifications	p. 19
Construction	p. 20
Dimensions	p. 21
Auto Switch Mounting	p. 24
Specific Product Precautions	p. 28

Auto Switch

JXC5H/6H Series

Controllers *JXC□ Series* p. 32

High Performance Controller (Step Data Input Type) *JXC5H/6H Series* Battery-less Absolute (Step Motor 24 VDC)



How to Order	p. 33
Specifications	p. 33
Dimensions	p. 35
Options	p. 39
Actuator Cable	p. 45

High Performance Step Motor Controller *JXCEH/9H/PH Series* Battery-less Absolute (Step Motor 24 VDC)



How to Order	p. 40
Specifications	p. 41
Dimensions	p. 42
Options	p. 44
Actuator Cable	p. 45

JXCEH/9H/PH Series

Specific Product Precautions

Battery-less Absolute Encoder Type Specific Product Precautions	p. 46
CE/UKCA/UL-compliance List	p. 47

Model Selection



Selection Procedure

Positioning Control Selection Procedure



Selection Example

Step 1 Check the work load-speed. <Speed-Work load graph> (pages 11 to 13)
 Select a model based on the workpiece mass and speed while referencing the speed-work load graph.
 Selection example) The LESYH16□GA-100 can be temporarily selected as a possible candidate based on the graph shown on the right side.

Step 2 Check the cycle time.
 Calculate the cycle time using the following calculation method.

Cycle time:

T can be found from the following equation.

$$T = T1 + T2 + T3 + T4 \text{ [s]}$$

- T1: Acceleration time and T3: Deceleration time can be found by the following equation.

$$T1 = V/a1 \text{ [s]} \quad T3 = V/a2 \text{ [s]}$$

- T2: Constant speed time can be found from the following equation.

$$T2 = \frac{L - 0.5 \cdot V \cdot (T1 + T3)}{V} \text{ [s]}$$

- T4: Settling time varies depending on the conditions such as motor types, load, and in position of the step data. Therefore, calculate the settling time while referencing the following value.

$$T4 = 0.1 \text{ [s]}$$

Calculation example)
 T1 to T4 can be calculated as follows.

$$T1 = V/a1 = 600/5000 = 0.12 \text{ [s]}$$

$$T3 = V/a2 = 600/5000 = 0.12 \text{ [s]}$$

$$T2 = \frac{L - 0.5 \cdot V \cdot (T1 + T3)}{V} = \frac{100 - 0.5 \cdot 600 \cdot (0.12 + 0.12)}{600} = 0.05 \text{ [s]}$$

$$T4 = 0.1 \text{ [s]}$$

The cycle time can be found as follows.

$$T = T1 + T2 + T3 + T4 = 0.12 + 0.05 + 0.12 + 0.1 = 0.39 \text{ [s]}$$

Operating conditions

- Workpiece mass: 1 [kg]
- Workpiece mounting condition:
- Speed: 600 [mm/s]
- Mounting orientation: Vertical
- Stroke: 100 [mm]
- Acceleration/Deceleration: 5000 [mm/s²]
- Cycle time: 0.4 s

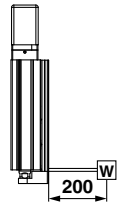

LESYH16□G/Step Motor Vertical Lead 12

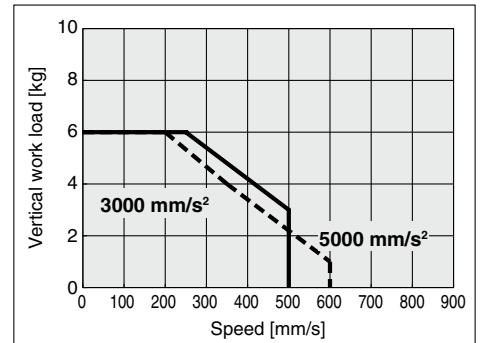

<Speed-Work load graph>

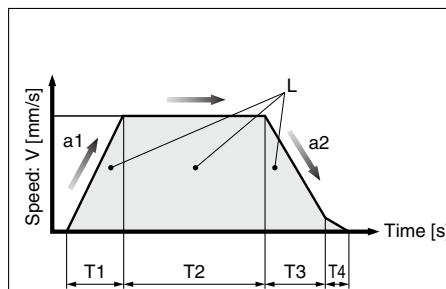

- L : Stroke [mm] (Operating condition)
- V : Speed [mm/s] (Operating condition)
- a1: Acceleration [mm/s²] ... (Operating condition)
- a2: Deceleration [mm/s²] ... (Operating condition)

- T1: Acceleration time [s] ... Time until reaching the set speed
- T2: Constant speed time [s] ... Time while the actuator is operating at a constant speed
- T3: Deceleration time [s] ... Time from the beginning of the constant speed operation to stop
- T4: Settling time [s] ... Time until positioning is completed

Step 3 Check the allowable moment.
 <Static allowable moment> (page 13)
 <Dynamic allowable moment> (pages 15, 16)

Confirm the moment that applies to the actuator is within the allowable range for both static and dynamic conditions.

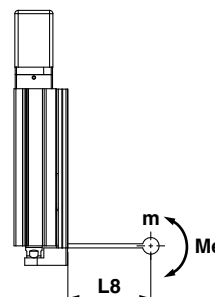

LESYH16/Pitching

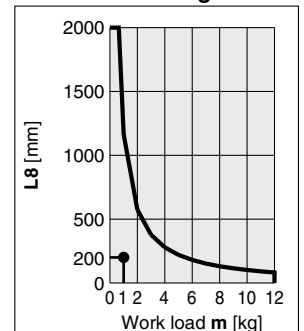

<Dynamic allowable moment>

Based on the above calculation result, the LESYH16□GA-100 should be selected.

Selection Procedure

Pushing Control Selection Procedure



Selection Example

Operating conditions

- Pushing force: 100 N
- Mounting position: Vertical upward
- Workpiece mass: 1 kg
- Pushing time + Operation (A): 1.5 s
- Speed: 100 mm/s
- Full cycle time (B): 10 s
- Stroke: 100 mm

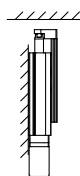

Step 1 Check the required force.

Calculate the approximate required force for a pushing operation.
 Selection example) ● Pushing force: 100 [N]

- Workpiece mass: 1 [kg]

The approximate required force can be found to be $100 + 10 = 110$ [N].

Select a model based on the approximate required force while referencing the specifications (page 19).

Selection example based on the specifications)

- Approximate required force: 110 [N]
- Speed: 100 [mm/s]

The **LESYH16□GA** can be temporarily selected as a possible candidate.

Then, calculate the required force for a pushing operation. If the mounting position is vertical upward, add the actuator table weight.

Selection example based on the table weight)

- **LESYH16□GA** table weight: 0.7 [kg]

The required force can be found to be $110 + 7 = 117$ [N].

Step 2 Check the pushing force.

<Pushing force set value–Force graph> (page 14)

Select a model based on the required force while referencing the pushing force set value–force graph, and confirm the pushing force set value.

Selection example based on the graph shown on the right side)

- Required force: 117 [N]

The **LESYH16□GA** can be temporarily selected as a possible candidate.

The pushing force set value is 64 [%].

Step 3 Check the duty ratio.

Confirm the allowable duty ratio based on the pushing force set value while referencing the allowable duty ratio.

Selection example based on the allowable duty ratio)

- Pushing force set value: 64 [%]

The allowable duty ratio can be found to be 20 [%].

Calculate the duty ratio for the operating conditions, and confirm it does not exceed the allowable duty ratio.

Selection example) ● Pushing time + Operation (A): 1.5 s

- Full cycle time (B): 10 s

The duty ratio can be found to be $1.5/10 \times 100 = 15$ [%], and this is within the allowable range.

Step 4 Check the allowable moment.

<Static allowable moment> (page 13)

<Dynamic allowable moment> (pages 15, 16)

Confirm the moment that applies to the actuator is within the allowable range for both static and dynamic conditions.

Table Weight

Unit [kg]

Model	Stroke [mm]			
	50	75	100	150
LESYH8	0.2	0.3	—	—
LESYH16	0.4	—	0.7	—
LESYH25	0.9	—	1.3	1.7

* If the mounting position is vertical upward, add the table weight.

LESYH16□G□/High Performance Battery-less Absolute

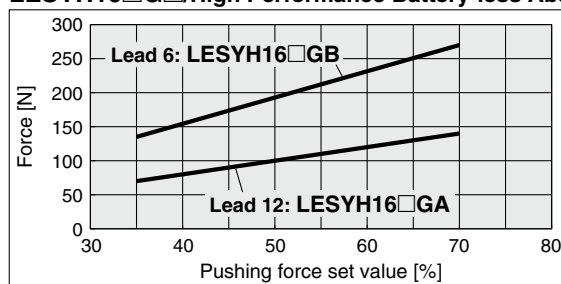

<Pushing force set value–Force graph>

Allowable Duty Ratio

Step Motor (Servo 24 VDC)

Pushing force set value [%]	Duty ratio [%]	Continuous pushing time [min]
35	—	—
50 or less	30 or less	5 or less
70 or less	20 or less	3 or less

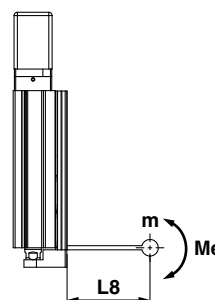
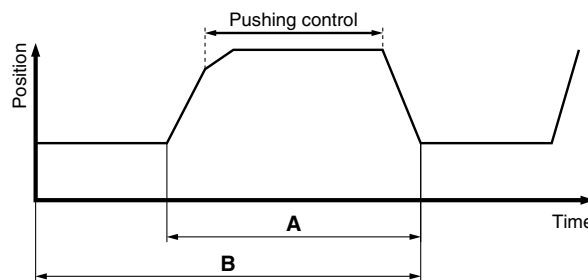

LESYH16/Pitching

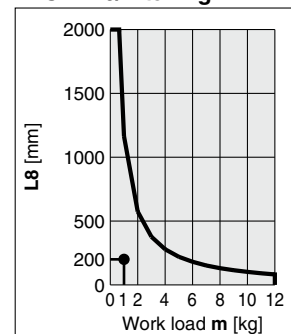

<Dynamic allowable moment>

Based on the above calculation result, the **LESYH16□GA-100** should be selected.

Speed-Work Load Graph (Guide)

LESYH8□G

Horizontal/Lead 10

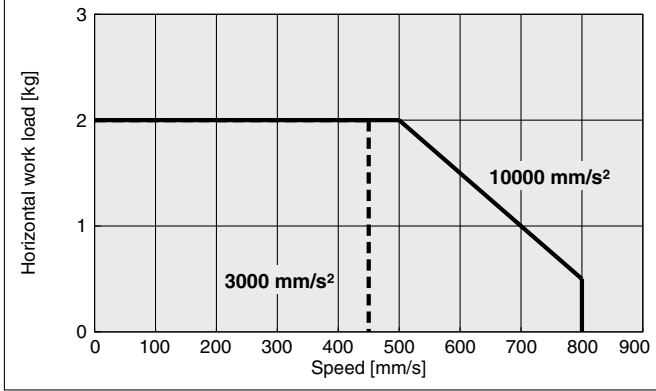

Vertical/Lead 10

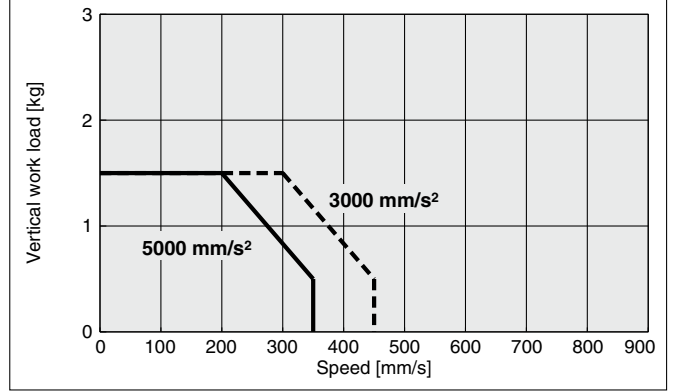

Horizontal/Lead 5

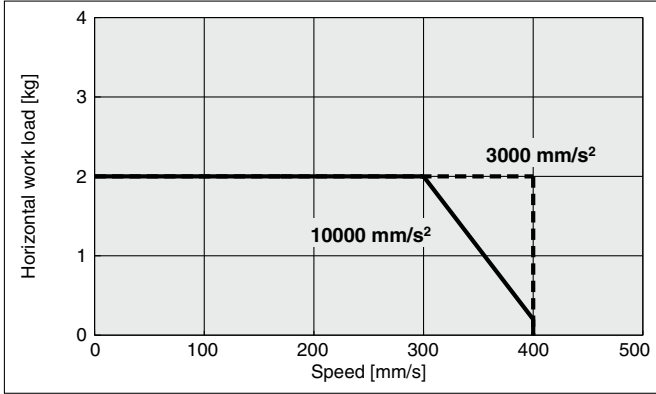

Vertical/Lead 5

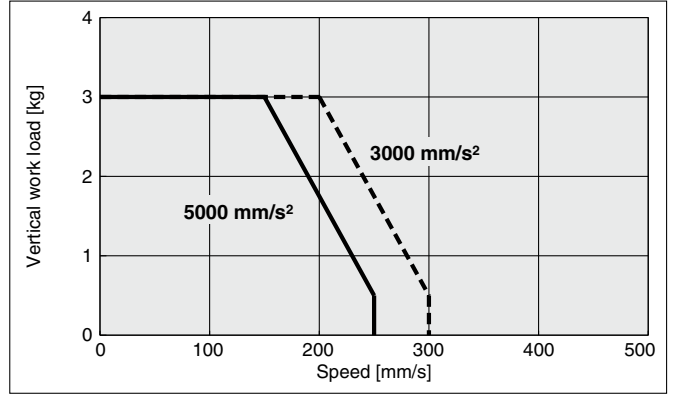

Horizontal/Lead 2.5

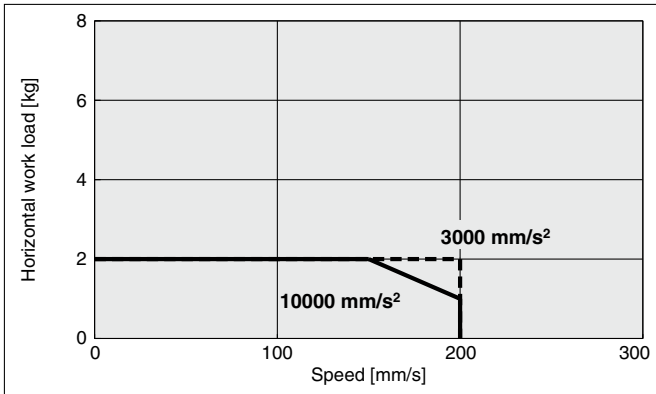

Vertical/Lead 2.5

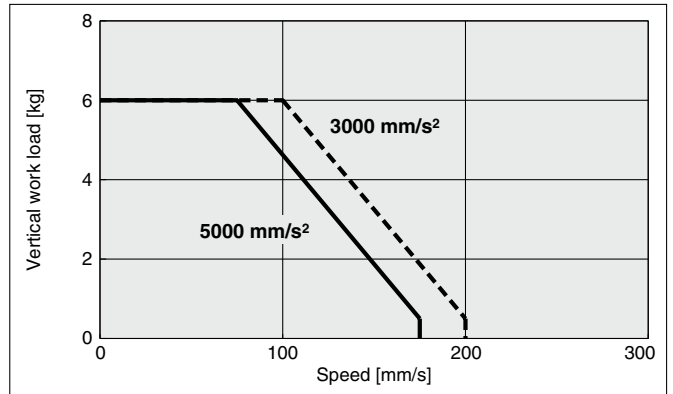

Operating temperature: Use products with a duty ratio of 100% or less when the temperature is below 30°C and with a duty ratio of 40% or less when the temperature exceeds 30°C.

Speed-Work Load Graph (Guide)

LESYH16□G

Horizontal/Lead 12

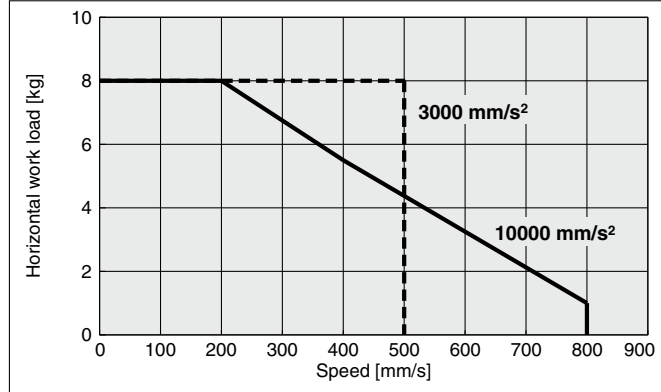

Vertical/Lead 12

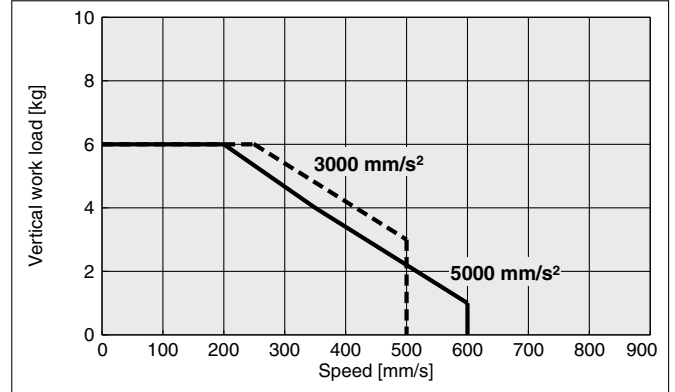

Horizontal/Lead 6

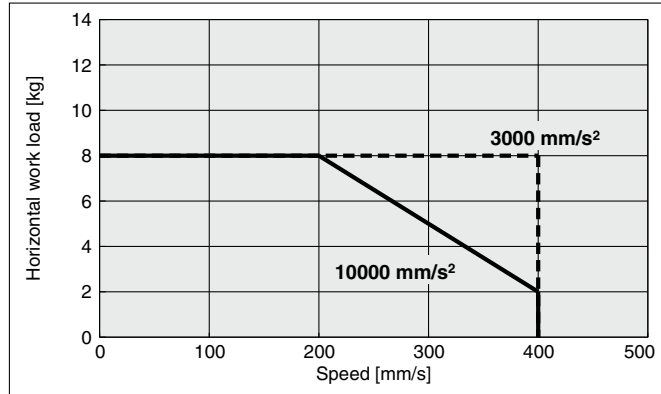

Vertical/Lead 6

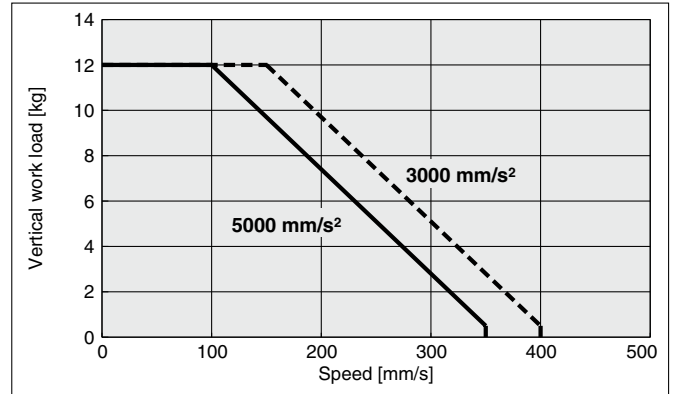

Operating temperature: Use products with a duty ratio of 100% or less when the temperature is below 30°C and with a duty ratio of 40% or less when the temperature exceeds 30°C.

Model Selection

LESYH□G Series

Auto Switch

JXC5H/6H Series

JXCEH/9H/PH Series

Specific Product Precautions

Speed-Work Load Graph (Guide)

LESYH25□G

Horizontal/Lead 16

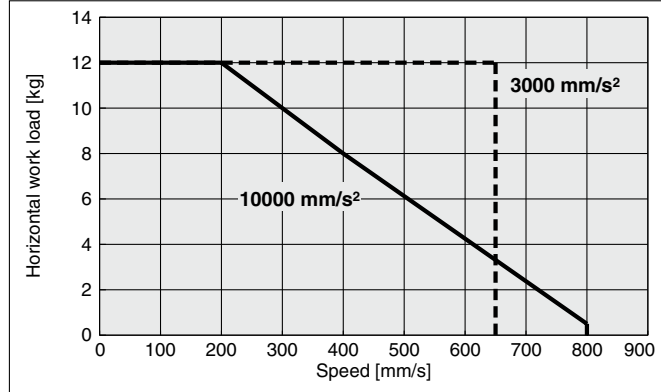

Vertical/Lead 16

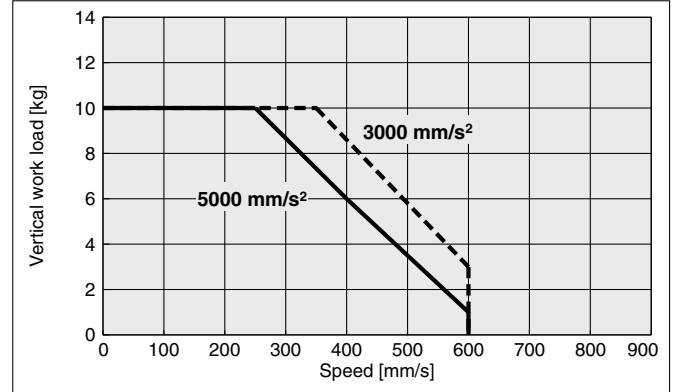

Horizontal/Lead 8

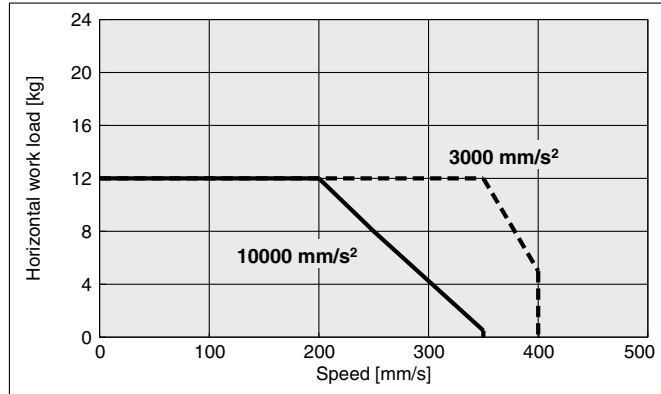

Vertical/Lead 8

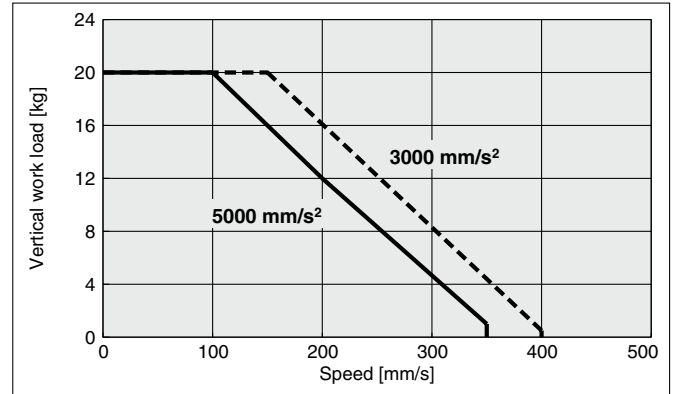

Operating temperature: Use products with a duty ratio of 100% or less when the temperature is below 30°C and with a duty ratio of 40% or less when the temperature exceeds 30°C.

Static Allowable Moment

Model	LESYH8		LESYH16		LESYH25		
Stroke [mm]	50	75	50	100	50	100	150
Pitching [N·m]	11		26	43	77	112	155
Yawing [N·m]	11		26	43	77	112	155
Rolling [N·m]	12		48		146	177	152

Pushing Force Set Value–Force Graph

LESYH8□G□

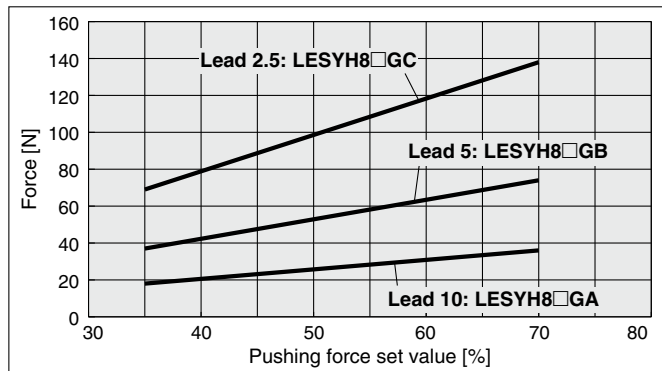

LESYH16□G□

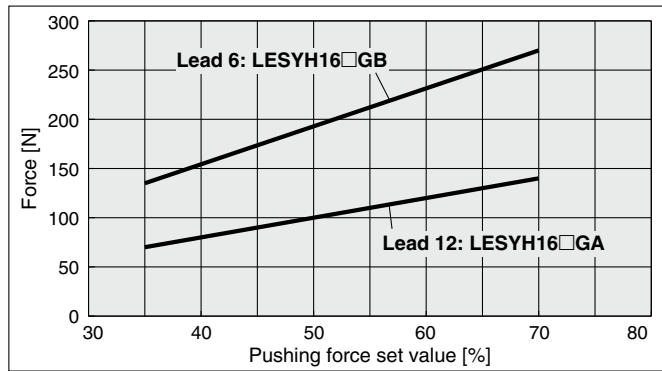

LESYH25□G□

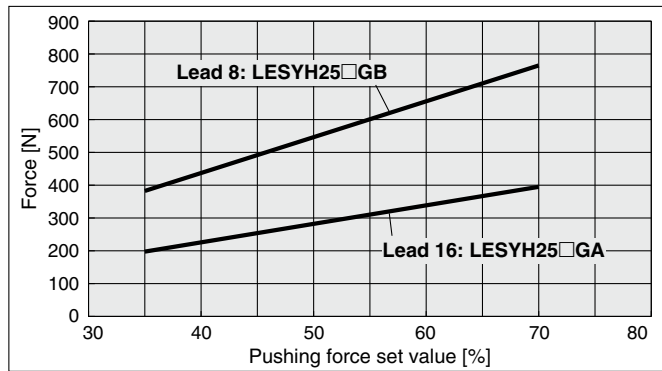

* These graphs show the amount of allowable overhang (guide unit) when the center of gravity of the work-piece overhangs in one direction. When selecting the overhang, refer to the "Calculation of Guide Load Factor" or the Electric Actuator Model Selection Software for confirmation: <https://www.smcworld.com>

Dynamic Allowable Moment

Acceleration/Deceleration Horizontal: 10000 mm/s² Vertical: 5000 mm/s²

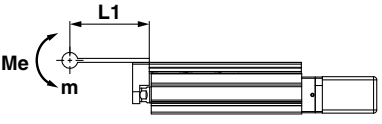
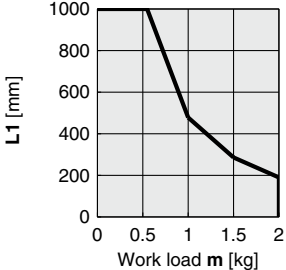
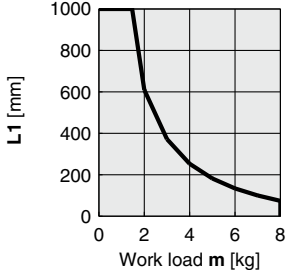
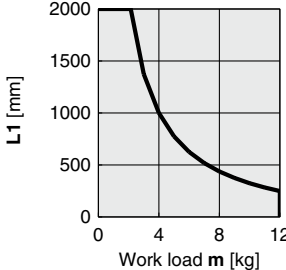
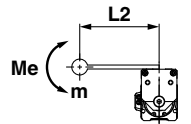
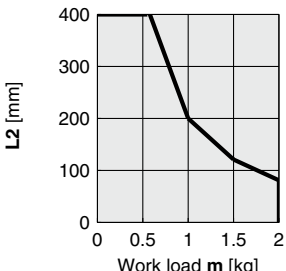
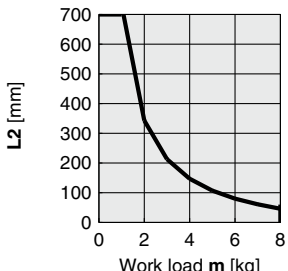
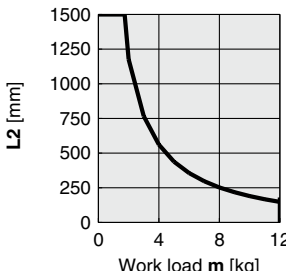
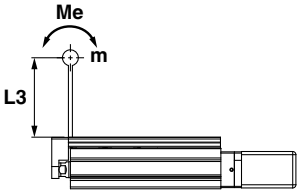
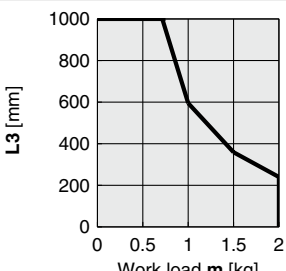
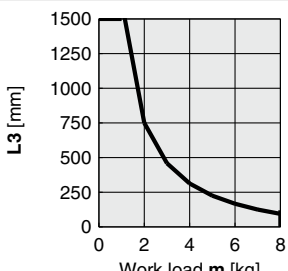
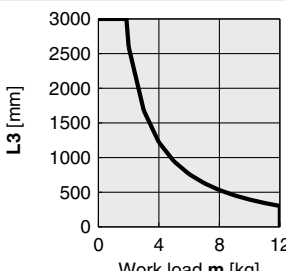
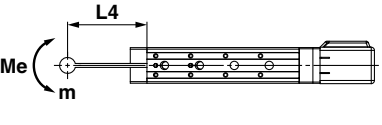
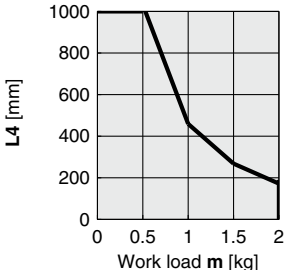
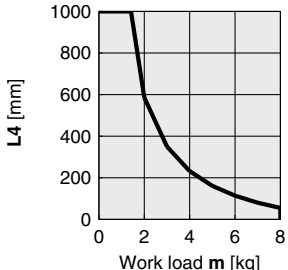
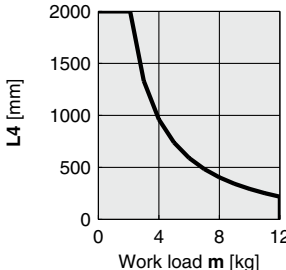
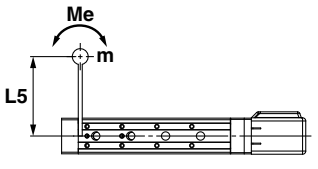
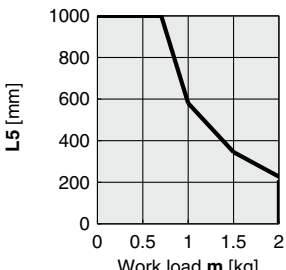
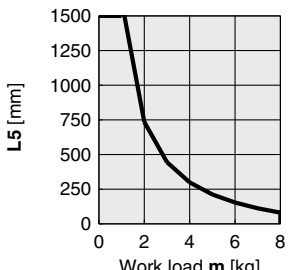
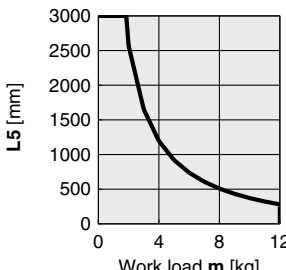
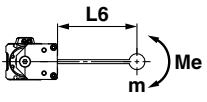
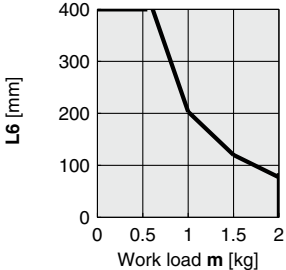
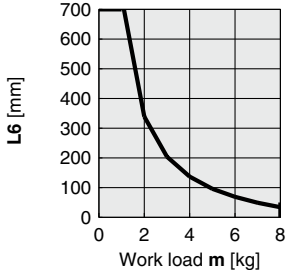
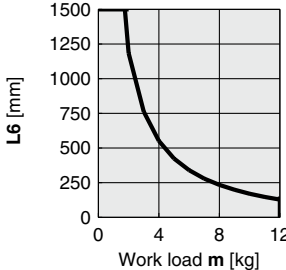
Orientation Load overhanging direction m: Work load [kg] Me: Allowable moment [N·m] L: Overhang to the work load center of gravity [mm]		Model		
		LESYH8	LESYH16	LESYH25
Horizontal/Bottom	 <p>X</p>			
	 <p>Y</p>			
	 <p>Z</p>			
Horizontal (Wall)	 <p>X</p>			
	 <p>Y</p>			
	 <p>Z</p>			

* These graphs show the amount of allowable overhang (guide unit) when the center of gravity of the work-piece overhangs in one direction. When selecting the overhang, refer to the "Calculation of Guide Load Factor" or the Electric Actuator Model Selection Software for confirmation: <https://www.smcworld.com>

Dynamic Allowable Moment

Acceleration/Deceleration Horizontal: 10000 mm/s² Vertical: 5000 mm/s²

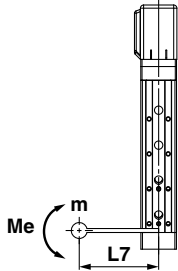
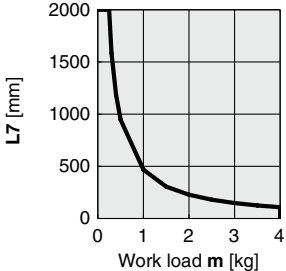
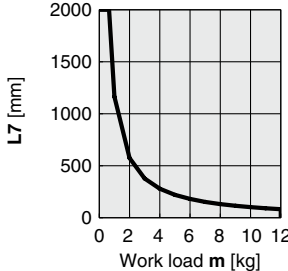
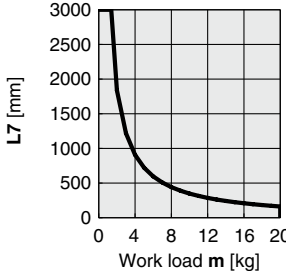
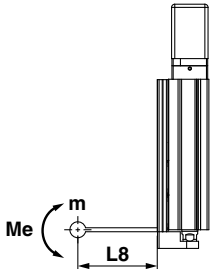
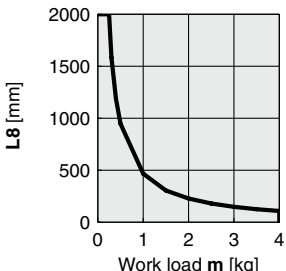
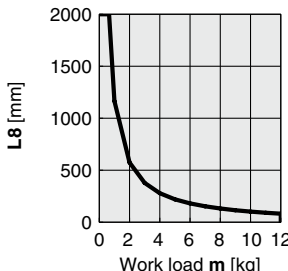
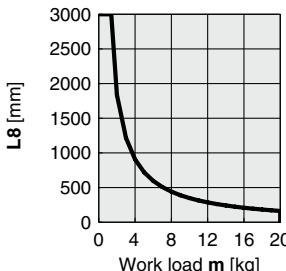
Orientation	Load overhanging direction m: Work load [kg] Me: Allowable moment [N·m] L: Overhang to the work load center of gravity [mm]	Model		
		LESYH8	LESYH16	LESYH25
Vertical	Y 			
	Z 			

Calculation of Guide Load Factor

- Decide operating conditions.

Model: LESYH

Size: 16

Mounting orientation: Horizontal/Bottom/Wall/Vertical

Acceleration [mm/s²]: a

Work load [kg]: m

Work load center position [mm]: Xc/Yc/Zc

- Select the target graph while referencing the model, size, and mounting orientation.

- Based on the acceleration and work load, find the overhang [mm]: Lx/Ly/Lz from the graph.

- Calculate the load factor for each direction.

$$\alpha_x = X_c/L_x, \alpha_y = Y_c/L_y, \alpha_z = Z_c/L_z$$

- Confirm the total of α_x , α_y , and α_z is 1 or less.

$$\alpha_x + \alpha_y + \alpha_z \leq 1$$

When 1 is exceeded, consider a reduction of acceleration and work load, or a change of the work load center position and series.

Mounting orientation

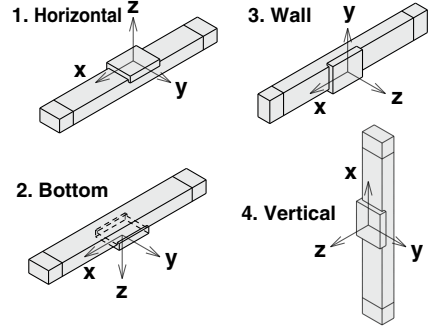

Example

- Operating conditions

Model: LESYH

Size: 16

Mounting orientation: Horizontal

Acceleration [mm/s²]: 5000

Work load [kg]: 4.0

Work load center position [mm]: Xc = 80, Yc = 50, Zc = 60

- Select three graphs from the top of the second row on page 15.

- Lx = 250 mm, Ly = 160 mm, Lz = 700 mm

- The load factor for each direction can be found as follows.

$$\alpha_x = 80/250 = 0.32$$

$$\alpha_y = 50/160 = 0.32$$

$$\alpha_z = 60/700 = 0.09$$

- $\alpha_x + \alpha_y + \alpha_z = 0.73 \leq 1$

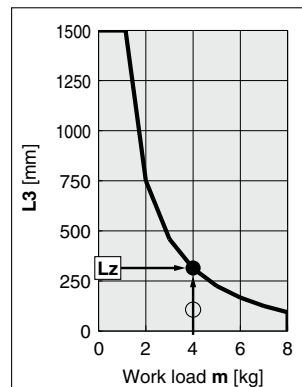
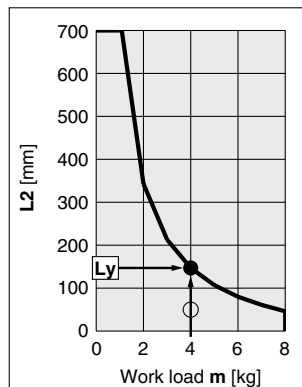
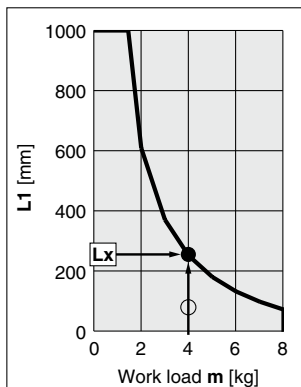

High Performance Slide Table/ High Precision Type LESYH□G Series



* For details, refer to page 47 and onward.

How to Order

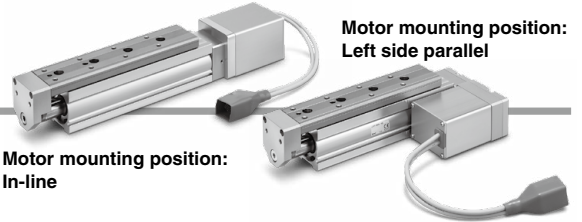

Motor mounting position:
In-line

Motor mounting position:
Left side parallel

LESYH **16** **D** **G** **A** - **50** **C** - **R1** **C5H73**

①
②
③
④
⑤
⑥
⑦
⑧

For details on controllers, refer to the next page.

① Size

8
16
25

② Motor mounting position/Motor cover direction (For size 8)

Symbol	Motor mounting position	Motor cover direction
D1	In-line	Left side
D2		Right side
D3		Top side
D4		Bottom side
R	Right side parallel	—
L	Left side parallel	—

② Motor mounting position (For sizes 16 and 25)

D	In-line
R	Right side parallel
L	Left side parallel

③ Motor type

Symbol	Type	Compatible controllers
G	High performance (Battery-less absolute)	JXC5H JXC6H JXCEH JXC9H JXCPH

④ Lead [mm]

	Size		
	8	16	25
A	10	12	16
B	5	6	8
C	2.5	—	—

⑤ Stroke [mm]

	Size		
	8	16	25
50	●	●	●
75	●	—	—
100	—	●	●
150	—	—	●

⑥ Motor option

C	Without lock
W	With lock

⑦ Connector/Actuator cable type/length

Robotic cable [m]			
Nil	Without cable	R8	8*1
R1	1.5	RA	10*1
R3	3	RB	15*1
R5	5	RC	20*1

For details on auto switches, refer to pages 24 to 27.

8 Controller

Nil	Without controller
C□H□□	With controller

C 5 H 7 3

Interface (Communication protocol/Input/Output)

5	Parallel input (NPN)
6	Parallel input (PNP)
E	EtherCAT
9	EtherNet/IP™
P	PROFINET

Mounting

7	Screw mounting
8*2	DIN rail

Number of axes/Special specification

H	1 axis/High performance type
---	------------------------------

I/O cable

Symbol	Type	Applicable interface
Nil	Without accessory	—
1	I/O cable (1.5 m)	Parallel input (NPN) Parallel input (PNP)
3	I/O cable (3 m)	
5	I/O cable (5 m)	

- *1 Produced upon receipt of order
- *2 The DIN rail is not included. It must be ordered separately.

⚠ Caution

[CE/UKCA-compliant products]

EMC compliance was tested by combining the electric actuator LES series and the controller JXC series.

The EMC depends on the configuration of the customer's control panel and the relationship with other electrical equipment and wiring. Therefore, compliance with the EMC directive cannot be certified for SMC components incorporated into the customer's equipment under actual operating conditions. As a result, it is necessary for the customer to verify compliance with the EMC directive for the machinery and equipment as a whole.

■ Trademark

EtherNet/IP® is a registered trademark of ODVA, Inc.
 EtherCAT® is registered trademark and patented technology, licensed by Beckhoff Automation GmbH, Germany.

The actuator and controller are sold as a package.

Confirm that the combination of the controller and actuator is correct.

<Check the following before use.>

- *1 Check the actuator label for the model number.
This number should match that of the controller.

LESYH16RGA-50

*1



- * Refer to the Operation Manual for using the products.
Please download it via our website: <https://www.smcworld.com>

Type	Step data input type	EtherCAT direct input type	EtherNet/IP™ direct input type	PROFINET direct input type
Series	JXC5H JXC6H	JXCEH	JXC9H	JXCPH
Features	Parallel I/O	EtherCAT direct input	EtherNet/IP™ direct input	PROFINET direct input
Compatible motor	Battery-less absolute (Step motor 24 VDC)			
Max. number of step data	64 points			
Power supply voltage	24 VDC			
Reference page	33	40		

Model Selection

LESYH□G Series

Auto Switch

JXC5H/6H Series

JXCEH/9H/PH Series

Specific Product Precautions

Specifications

Model		LESYH8□GA	LESYH8□GB	LESYH8□GC	LESYH16□GA	LESYH16□GB	LESYH25□GA	LESYH25□GB	
Actuator specifications	Stroke [mm]	50, 75			50, 100		50, 100, 150		
	Max. work load [kg]*1 *3	Horizontal	2			8		12	
		Vertical	1.5	3	6	6	12	10	20
	Pushing force 35% to 70% [N]*2 *3	18 to 36	37 to 74	69 to 138	70 to 140	135 to 270	197 to 395	382 to 765	
	Speed [mm/s]*1 *3	20 to 800	10 to 400	5 to 200	20 to 800	10 to 400	20 to 800	10 to 400	
	Pushing speed [mm/s]	20 to 30	10 to 30	5 to 30	20 to 30	10 to 30	20 to 30	10 to 30	
	Max. acceleration/ deceleration [mm/s ²]	Horizontal	10000						
		Vertical	5000						
	Positioning repeatability [mm]	±0.01							
	Lost motion [mm]*4	0.1 or less							
	Screw lead [mm]	10	5	2.5	12	6	16	8	
	Impact/Vibration resistance [m/s ²]*5	50/20							
	Actuation type	Ball screw: LESYH□D Ball screw + Belt: LESYH□(R, L)							
Guide type	Linear guide (Circulating type)								
Operating temperature range [°C]	5 to 40								
Operating humidity range [%RH]	90 or less (No condensation)								
Electric specifications	Motor size	□28			□42		□56		
	Motor type	Step motor (Servo/24 VDC)							
	Encoder (Angular displacement sensor)	Battery-less absolute							
	Rated voltage [V]	24 VDC ±10%							
Lock unit specifications	Power [W]*6	Max. 116			Max. 126		Max. 222		
	Type	Non-magnetizing lock							
	Holding force [N]	20	39	78	78	157	108	216	
	Power consumption [W]*8	2.9			5				
Rated voltage [V]	24 VDC ±10%								

*1 For the speed, acceleration, and duty ratio according to the work load, check the "Speed-Work Load Graph" on pages 11 to 13.

*2 Pushing force accuracy is ±20% (F.S.).

*3 The speed and force may change depending on the cable length, load, and mounting conditions.

Furthermore, if the cable length exceeds 5 m, then it will decrease by up to 10% for each 5 m. (At 15 m: Reduced by up to 20%)

*4 A reference value for correcting errors in reciprocal operation

*5 Vibration resistance: No malfunction occurred in a test ranging between 45 to 2000 Hz. The test was performed in both an axial direction and a perpendicular direction to the lead screw. (The test was performed with the actuator in the initial state.)

Impact resistance: No malfunction occurred when the actuator was tested with a drop tester in both an axial direction and a perpendicular direction to the lead screw. (The test was performed with the actuator in the initial state.)

*6 Indicates the max. power during operation (including the controller)

This value can be used for the selection of the power supply.

*7 With lock only

*8 For an actuator with lock, add the power for the lock.

Weight

Product Weight

[kg]

Model	Stroke			
	50	75	100	150
LESYH8□G	1.06	1.23	—	—
LESYH16□G	2.39	—	2.78	—
LESYH25□G	4.82	—	5.42	6.22

Additional Weight

[kg]

Size	8	16	25
With lock	0.16	0.32	0.61

Construction

Right side parallel/R type, Left side parallel/L type

* The figures show the R type.

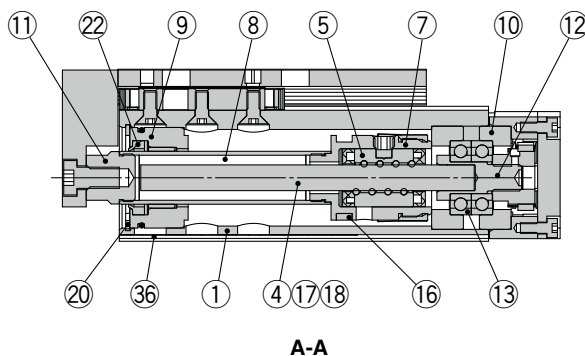
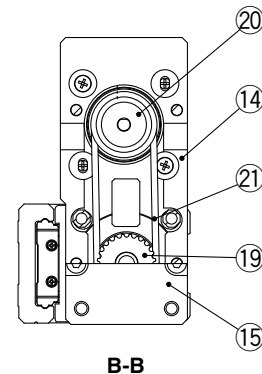
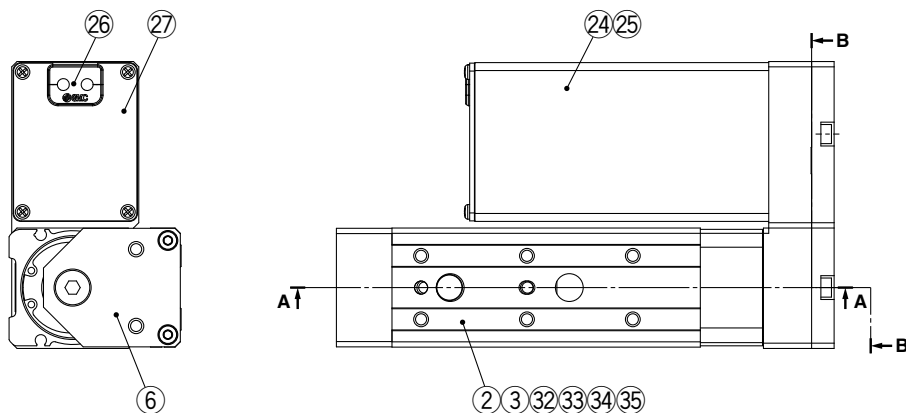

In-line/D type

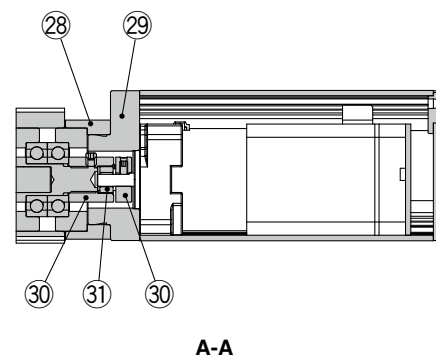

Component Parts

No.	Description	Material	Note
1	Body	Aluminum alloy	Anodized
2	Table	Stainless steel	—
3	Guide block	Alloy steel	—
4	Ball screw shaft	Alloy steel	—
5	Ball screw nut	Resin/Alloy steel	—
6	End plate	Aluminum alloy	Anodized
7	Piston	Aluminum alloy	—
8	Piston rod	Stainless steel	Hard chrome plating
9	Rod cover	Aluminum alloy	—
10	Bearing holder	Aluminum alloy	—
11	Socket	Free cutting steel	Electroless nickel plating
12	Connected shaft	Free cutting steel	Electroless nickel plating
13	Rolling bearing	—	—
14	Return box	Aluminum alloy	Anodized
15	Return plate	Aluminum alloy	Anodized
16	Magnet	—	—
17	Wear ring holder	Stainless steel	Only for size 25 with a 150 mm stroke
18	Wear ring	Resin	Only for size 25 with a 150 mm stroke

No.	Description	Material	Note
19	Screw shaft pulley	Aluminum alloy	—
20	Motor pulley	Aluminum alloy	—
21	Belt	—	—
22	Scraper	NBR	—
23	Type C retaining ring for hole	Steel for spring	Phosphate coating
24	Motor/Motor with lock	—	Depends on the part number
25	Motor cover	Aluminum alloy	Anodized
26	Grommet	NBR	—
27	Motor end cover	Aluminum alloy	Anodized
28	Motor block	Aluminum alloy	Anodized
29	Motor adapter	Aluminum alloy	Anodized
30	Hub	Aluminum alloy	—
31	Spider	NBR	—
32	Cover	Resin	—
33	Return guide	Resin	—
34	Scraper	NBR	—
35	Steel ball	Special steel	—
36	Masking tape	—	—

Model Selection

LESYH□G Series

Auto Switch

JXC5H/6H Series

JXCEH/9H/PH Series

Specific Product Precautions

Dimensions

LESYH8D□G□-□

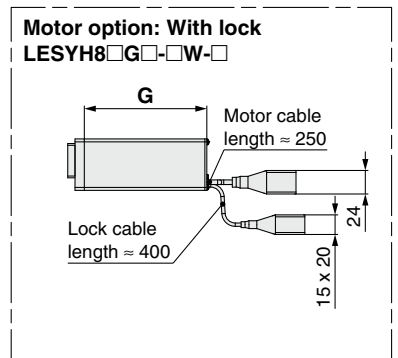
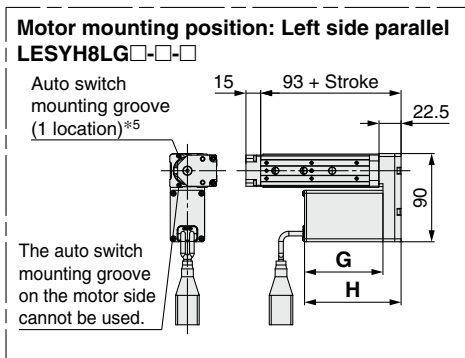
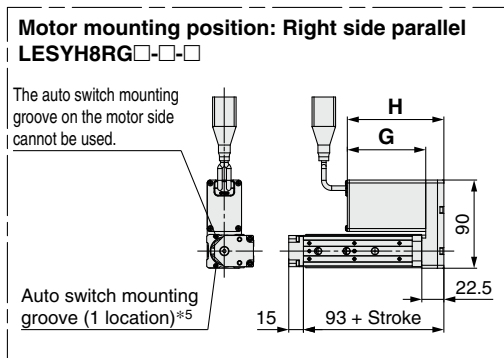
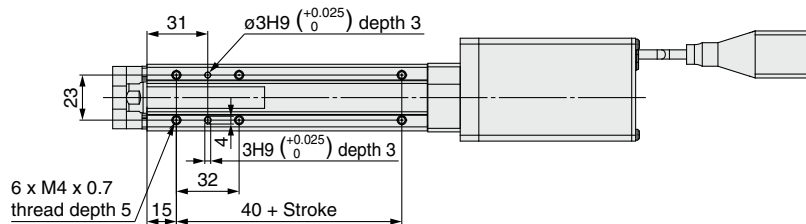
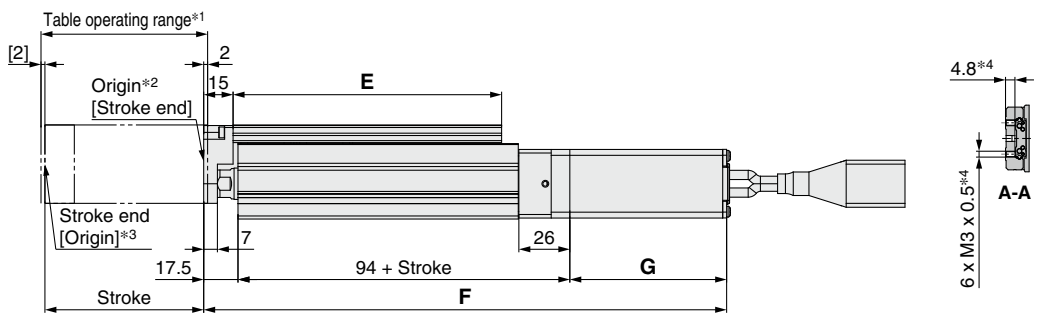
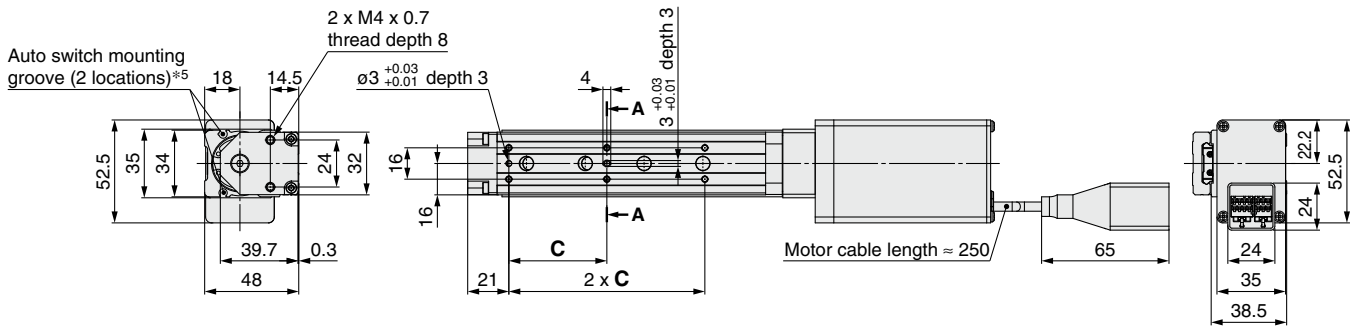

- *1 This is the range within which the table can move when it returns to origin.
Make sure that workpieces mounted on the table do not interfere with other workpieces or the facilities around the table.
- *2 Position after returning to origin
- *3 [] for when the direction of return to origin has changed
- *4 If the workpiece retaining screws are too long, they may come in contact with the guide block, resulting in a malfunction.
Use screws of a length equal to or shorter than the thread length.
- *5 For checking the limit and the intermediate signal. Applicable to the D-M9□, D-M9□E, and D-M9□W (2-color indicator)
The auto switches should be ordered separately. Refer to pages 25 to 27 for details.

Dimensions

[mm]

Model	Stroke	C	E	With motor cover			With lock/motor cover		
				F	G	H	F	G	H
LESYH8□G□	50	46	111	241.5	80	98.5	286.5	125	143.5
	75	50	137	266.5			311.5		

Dimensions

LESYH16DG□-□

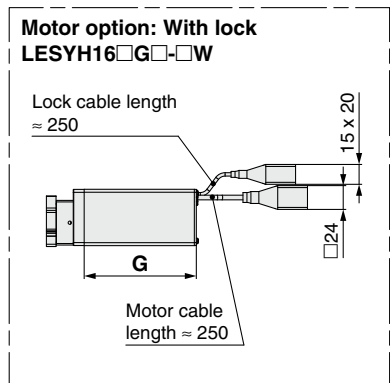
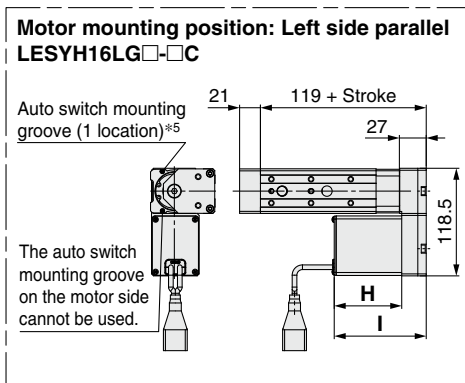
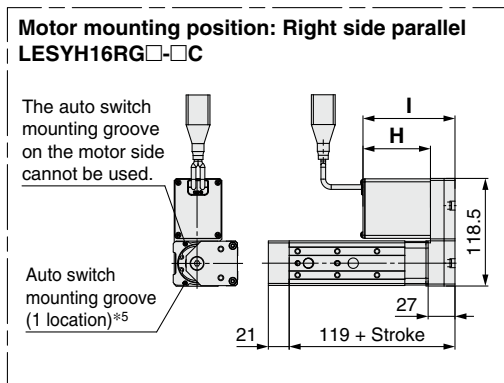
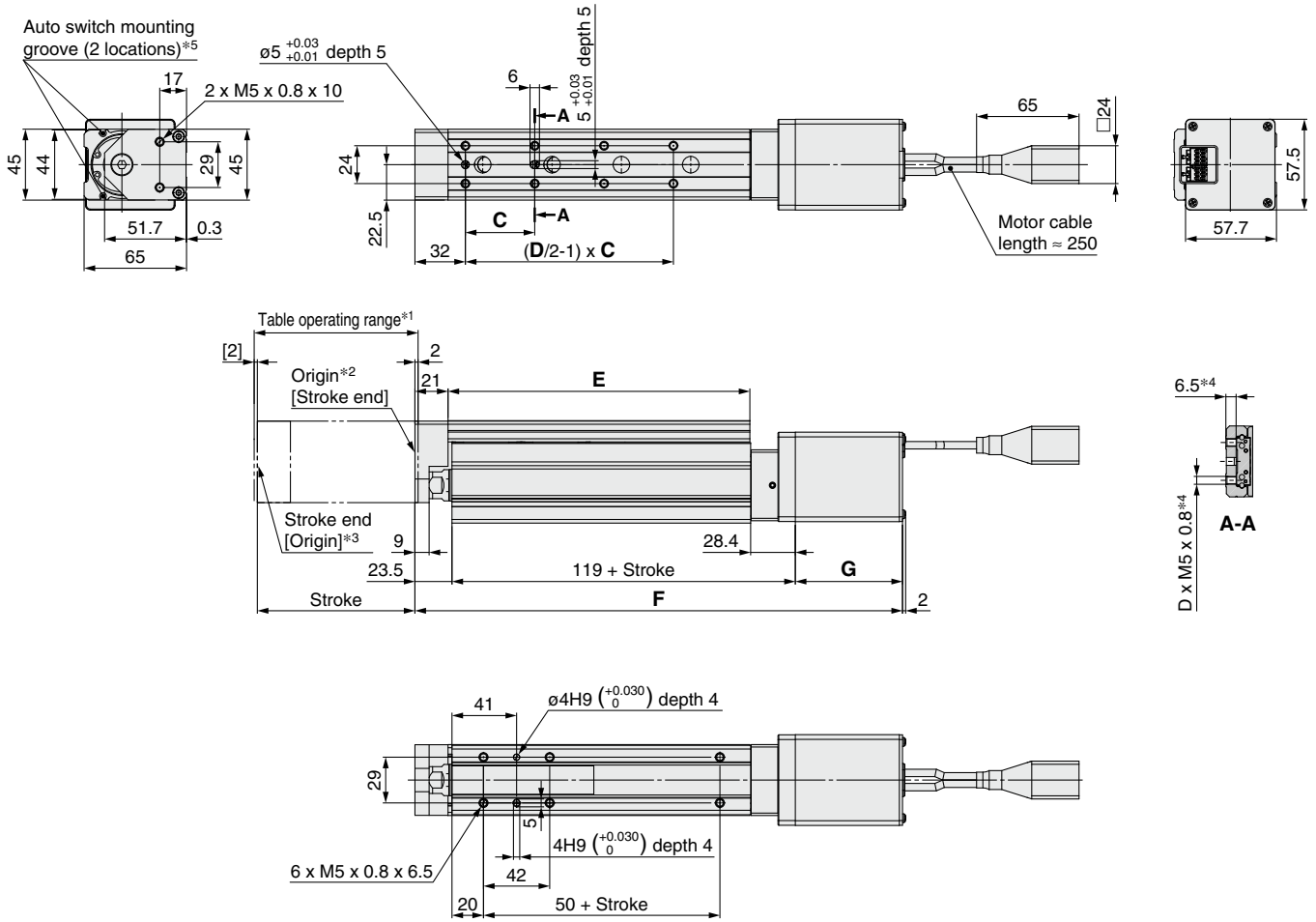

- *1 This is the range within which the table can move when it returns to origin.
Make sure that workpieces mounted on the table do not interfere with other workpieces or the facilities around the table.
- *2 Position after returning to origin
- *3 [] for when the direction of return to origin has changed
- *4 If the workpiece retaining screws are too long, they may come in contact with the guide block, resulting in a malfunction.
Use screws of a length equal to or shorter than the thread length.
- *5 For checking the limit and the intermediate signal. Applicable to the D-M9□, D-M9□E, and D-M9□W (2-color indicator)
The auto switches should be ordered separately. Refer to pages 25 to 27 for details.

Dimensions

[mm]

Model	Stroke	C	D	E	With motor cover			With lock/motor cover				
					F	G	H	I	F	G	H	I
LESYH16□G□	50	40	6	116.5	266.4	75	68	92.7	311.4	120	113	137.7
	100	44	8	191.5	316.4				361.4			

Dimensions

LESYH25DG□-□

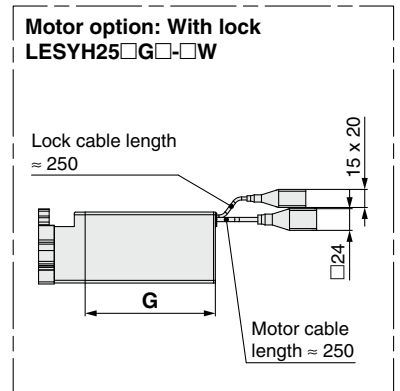
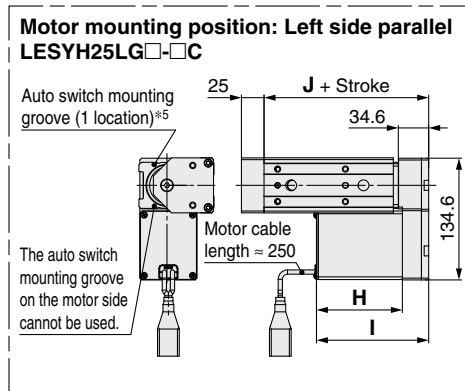
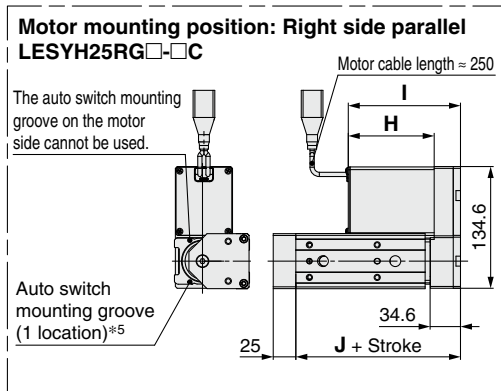
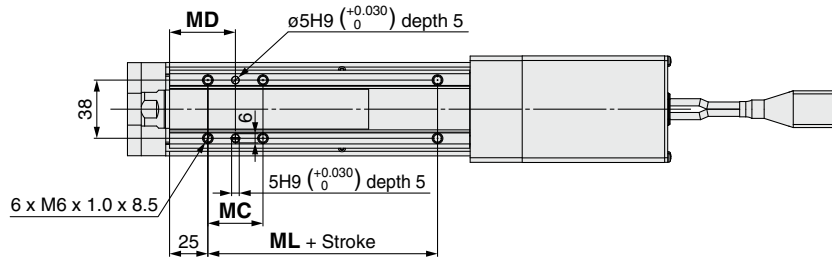
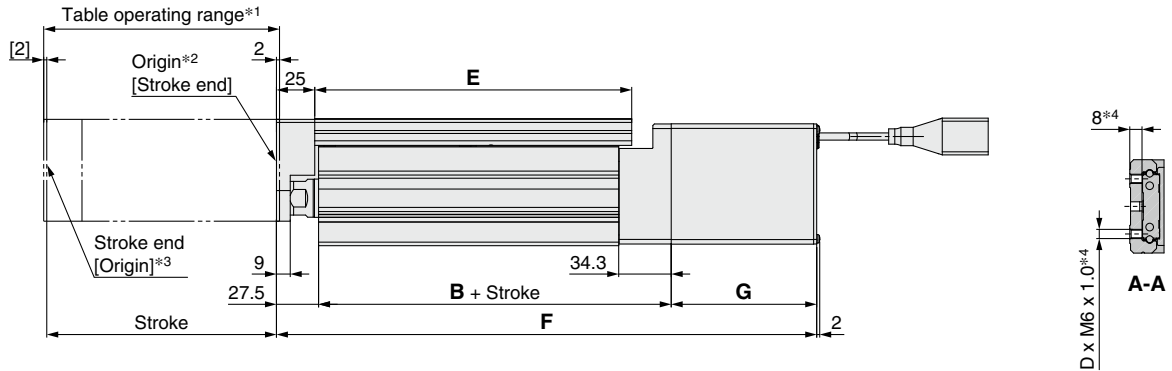
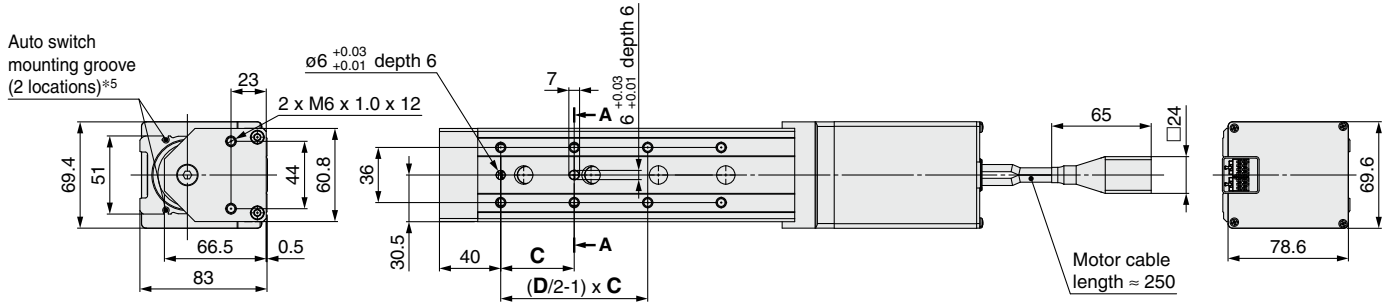

- *1 This is the range within which the table can move when it returns to origin.
Make sure that workpieces mounted on the table do not interfere with other workpieces or the facilities around the table.
- *2 Position after returning to origin
- *3 [] for when the direction of return to origin has changed
- *4 If the workpiece retaining screws are too long, they may come in contact with the guide block, resulting in a malfunction.
Use screws of a length equal to or shorter than the thread length.
- *5 For checking the limit and the intermediate signal. Applicable to the D-M9□, D-M9□E, and D-M9□W (2-color indicator)
The auto switches should be ordered separately. Refer to pages 25 to 27 for details.

Dimensions

Model	Stroke	B	C	D	E	With motor cover				With lock/motor cover				J	MC	MD	ML
						F	G	H	I	F	G	H	I				
LESYH25□G□	50	130.3	75	4	143	307.8	100	95	125.1	347.8	140	144	174.1	133.1	36	43	50
	100		48	207	357.8	397.8											
	150	65	8	285	437.8	477.8				163.1							

LESYH□G Series Auto Switch Mounting

Auto Switch Mounting Position



[mm]			
Size	Stroke	A	B
8	50	89	126
	75	114	152
16	50	100.5	137.5
	100	150.5	212.5
25	50	108	168
	100	158	232
	150	238	310

Auto Switch Mounting

When mounting the auto switches, they should be inserted into the actuator's auto switch mounting groove as shown in the drawing below. After setting in the mounting position, use a flat head watchmaker's screwdriver to tighten the auto switch mounting screw that is included.

Auto Switch Mounting Screw Tightening Torque [N·m]

Auto switch model	Tightening torque
D-M9□(V) D-M9□W(V) D-M9□E	0.05 to 0.15

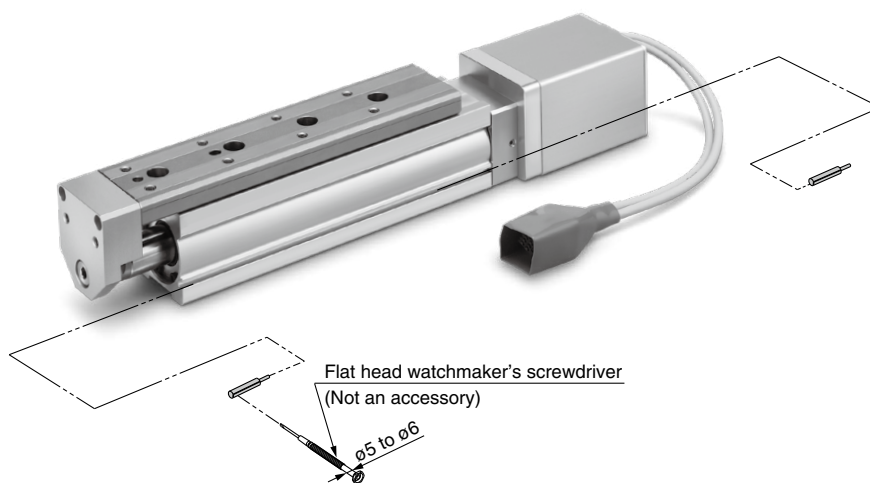

* When tightening the auto switch mounting screw (included with the auto switch), use a watchmaker's screwdriver with a handle diameter of about 5 to 6 mm.

Model Selection

LESYH□G Series

Auto Switch

JXC5H/6H Series

JXCEH/9H/PH Series

Specific Product Precautions

Solid State Auto Switch Direct Mounting Type

D-M9N(V)/D-M9P(V)/D-M9B(V)



Refer to the SMC website for details on products that are compliant with international standards.

PLC: Programmable Logic Controller

Grommet

- 2-wire load current is reduced (2.5 to 40 mA).
- Using flexible cable as standard spec.



Caution

Precautions

Fix the auto switch with the existing screw installed on the auto switch body. The auto switch may be damaged if a screw other than the one supplied is used.

Auto Switch Specifications

D-M9□, D-M9□V (With indicator light)						
Auto switch model	D-M9N	D-M9NV	D-M9P	D-M9PV	D-M9B	D-M9BV
Electrical entry direction	In-line	Perpendicular	In-line	Perpendicular	In-line	Perpendicular
Wiring type	3-wire				2-wire	
Output type	NPN		PNP		—	
Applicable load	IC circuit, Relay, PLC				24 VDC relay, PLC	
Power supply voltage	5, 12, 24 VDC (4.5 to 28 V)				—	
Current consumption	10 mA or less				—	
Load voltage	28 VDC or less		—		24 VDC (10 to 28 VDC)	
Load current	40 mA or less				2.5 to 40 mA	
Internal voltage drop	0.8 V or less at 10 mA (2 V or less at 40 mA)				4 V or less	
Leakage current	100 μA or less at 24 VDC				0.8 mA or less	
Indicator light	Red LED illuminates when turned ON.					
Standard	CE marking, RoHS					

Oilproof Flexible Heavy-duty Lead Wire Specifications

Auto switch model		D-M9N(V)	D-M9P(V)	D-M9B(V)
Sheath	Outside diameter [mm]	2.6		
Insulator	Number of cores	3 cores (Brown/Blue/Black)		2 cores (Brown/Blue)
	Outside diameter [mm]	0.88		
Conductor	Effective area [mm ²]	0.15		
	Strand diameter [mm]	0.05		
Min. bending radius [mm] (Reference values)		17		

- * Refer to the **Web Catalog** for solid state auto switch common specifications.
- * Refer to the **Web Catalog** for lead wire lengths.

Weight

[g]

Auto switch model		D-M9N(V)	D-M9P(V)	D-M9B(V)
Lead wire length	0.5 m (Nil)	8	7	7
	1 m (M)	14	13	13
	3 m (L)	41	38	38
	5 m (Z)	68	63	63

Dimensions

[mm]

D-M9□

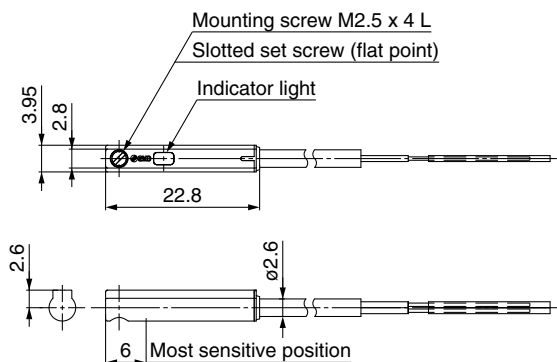

D-M9□V

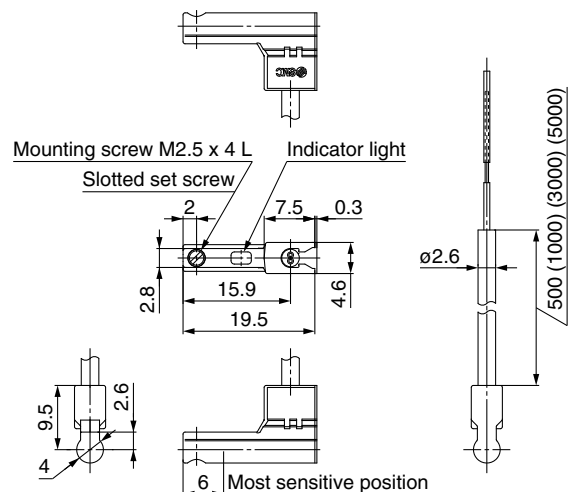

Normally Closed Solid State Auto Switch Direct Mounting Type

D-M9NE(V)/D-M9PE(V)/D-M9BE(V)

Refer to the SMC website for details on products that are compliant with international standards.

PLC: Programmable Logic Controller

Grommet

- Output signal turns on when no magnetic force is detected.
- Can be used for the actuator adopted by the solid state auto switch D-M9 series (excluding special order products)

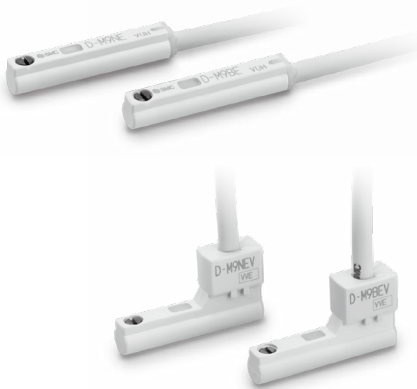

Caution

Precautions

Fix the auto switch with the existing screw installed on the auto switch body. The auto switch may be damaged if a screw other than the one supplied is used.

Auto Switch Specifications

D-M9□E, D-M9□EV (With indicator light)						
Auto switch model	D-M9NE	D-M9NEV	D-M9PE	D-M9PEV	D-M9BE	D-M9BEV
Electrical entry direction	In-line	Perpendicular	In-line	Perpendicular	In-line	Perpendicular
Wiring type	3-wire				2-wire	
Output type	NPN		PNP		—	
Applicable load	IC circuit, Relay, PLC				24 VDC relay, PLC	
Power supply voltage	5, 12, 24 VDC (4.5 to 28 V)				—	
Current consumption	10 mA or less				—	
Load voltage	28 VDC or less		—		24 VDC (10 to 28 VDC)	
Load current	40 mA or less				2.5 to 40 mA	
Internal voltage drop	0.8 V or less at 10 mA (2 V or less at 40 mA)				4 V or less	
Leakage current	100 μA or less at 24 VDC				0.8 mA or less	
Indicator light	Red LED illuminates when turned ON.					
Standard	CE marking, RoHS					

Oilproof Flexible Heavy-duty Lead Wire Specifications

Auto switch model	D-M9NE(V)	D-M9PE(V)	D-M9BE(V)
Sheath	Outside diameter [mm]		
	2.6		
Insulator	Number of cores		2 cores (Brown/Blue)
	Outside diameter [mm]		0.88
Conductor	Effective area [mm ²]		0.15
	Strand diameter [mm]		0.05
Min. bending radius [mm] (Reference values)			
17			

- * Refer to the **Web Catalog** for solid state auto switch common specifications.
- * Refer to the **Web Catalog** for lead wire lengths.

Weight

Auto switch model	D-M9NE(V)	D-M9PE(V)	D-M9BE(V)
Lead wire length	0.5 m (Nil)	8	7
	1 m (M)*1	14	13
	3 m (L)	41	38
	5 m (Z)*1	68	63

*1 The 1 m and 5 m options are produced upon receipt of order.

Dimensions

D-M9□E

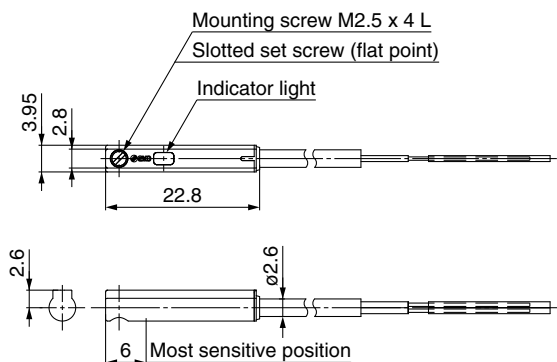

D-M9□EV

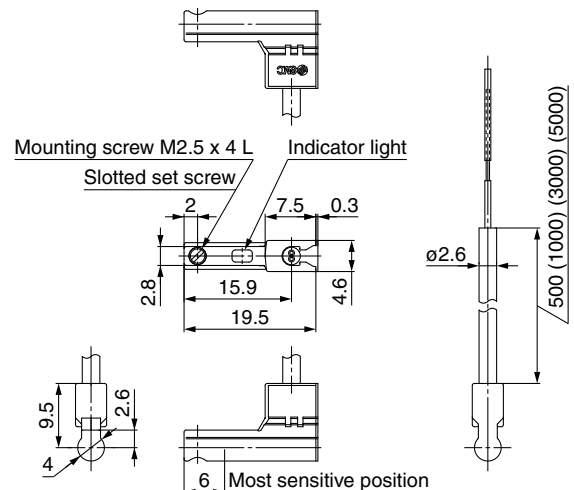

2-Color Indicator Solid State Auto Switch Direct Mounting Type

D-M9NW(V)/D-M9PW(V)/D-M9BW(V)



Refer to the SMC website for details on products that are compliant with international standards.

Grommet

- 2-wire load current is reduced (2.5 to 40 mA).
- Using flexible cable as standard spec.
- The proper operating range can be determined by the color of the light. (Red → Green ← Red)



Caution

Precautions

Fix the auto switch with the existing screw installed on the auto switch body. The auto switch may be damaged if a screw other than the one supplied is used.

Auto Switch Specifications

PLC: Programmable Logic Controller

D-M9□W, D-M9□WV (With indicator light)						
Auto switch model	D-M9NW	D-M9NWV	D-M9PW	D-M9PWV	D-M9BW	D-M9BWV
Electrical entry direction	In-line	Perpendicular	In-line	Perpendicular	In-line	Perpendicular
Wiring type	3-wire				2-wire	
Output type	NPN		PNP		—	
Applicable load	IC circuit, Relay, PLC				24 VDC relay, PLC	
Power supply voltage	5, 12, 24 VDC (4.5 to 28 V)				—	
Current consumption	10 mA or less				—	
Load voltage	28 VDC or less		—		24 VDC (10 to 28 VDC)	
Load current	40 mA or less				2.5 to 40 mA	
Internal voltage drop	0.8 V or less at 10 mA (2 V or less at 40 mA)				4 V or less	
Leakage current	100 μA or less at 24 VDC				0.8 mA or less	
Indicator light	Operating range Red LED illuminates. Proper operating range Green LED illuminates.					
Standard	CE marking, RoHS					

Oilproof Flexible Heavy-duty Lead Wire Specifications

Auto switch model		D-M9NW(V)	D-M9PW(V)	D-M9BW(V)
Sheath	Outside diameter [mm]	2.6		
Insulator	Number of cores	3 cores (Brown/Blue/Black)		2 cores (Brown/Blue)
	Outside diameter [mm]	0.88		
Conductor	Effective area [mm ²]	0.15		
	Strand diameter [mm]	0.05		
Min. bending radius [mm] (Reference values)		17		

- * Refer to the **Web Catalog** for solid state auto switch common specifications.
- * Refer to the **Web Catalog** for lead wire lengths.

Weight

[g]

Auto switch model		D-M9NW(V)	D-M9PW(V)	D-M9BW(V)
Lead wire length	0.5 m (Nil)	8	7	7
	1 m (M)	14	13	13
	3 m (L)	41	38	38
	5 m (Z)	68	63	63

Dimensions

[mm]

D-M9□W

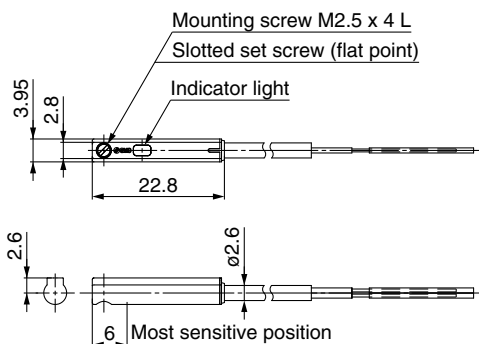

D-M9□WV

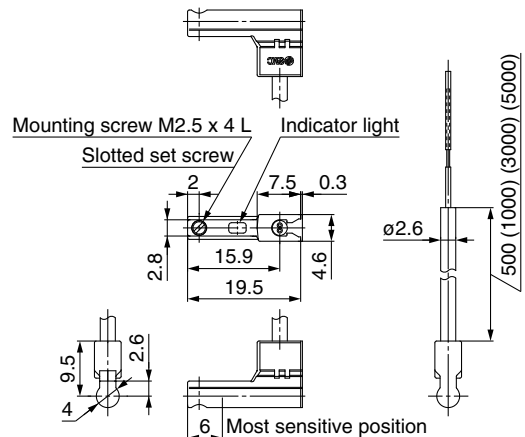



LESYH□G Series Specific Product Precautions 1

Be sure to read this before handling the products. Refer to the back cover for safety instructions. For electric actuator and auto switch precautions, refer to the “Handling Precautions for SMC Products” and the “Operation Manual” on the SMC website: <https://www.smcworld.com>

Design

Warning

- Do not apply a load in excess of the specification limits.**
Select a suitable actuator by work load and allowable moment. If the product is used outside of the specification limits, the eccentric load applied to the guide will be excessive and have adverse effects such as the generation of play on the guide, reduced accuracy, reduced service life of the product.
- Do not use the product in applications where excessive external force or impact force is applied to it.**
Doing so may result in a malfunction.

Handling

Caution

- INP output signal**
 - Positioning operation**
When the product comes within the set range of the step data [In position], the INP output signal will turn ON.
Initial value: Set to [0.50] or higher.
 - Pushing operation**
When the effective force exceeds the step data [Trigger LV], the INP output signal will turn ON. Use the product within the specified range of the [Pushing force] and [Trigger LV].
To ensure that the actuator pushes the workpieces with the set [Pushing force], it is recommended that the [Trigger LV] be set to the same value as the [Pushing force].
- The moving force should be 100%.**
If the moving force is set below the values above, it may cause the generation of an alarm.
- For pushing operations, set the product to a position at least 0.5 mm away from a workpiece. (This position is referred to as the pushing start position.)**
The following alarms may be generated and operation may become unstable if the product is set to the same position as a workpiece.
 - “Posn failed”**
The product cannot reach the pushing start position due to variations in the width of workpieces.
 - “Pushing ALM”**
The product is pushed back from the pushing start position after starting to push.

Handling

Caution

- Absolute encoder ID mismatch error at the first connection**
In the following cases, an “ID mismatch error” alarm occurs after the power is turned ON. Perform a return to origin operation after resetting the alarm before use.
 - When an electric actuator is connected and the power is turned ON for the first time after purchase*1
 - When the actuator or motor is replaced
 - When the controller is replaced

*1 If you have purchased an electric actuator and controller with the set part number, the pairing may have already been completed and the alarm may not be generated.

“ID mismatch error”

Operation is enabled by matching the encoder ID on the electric actuator side with the ID registered in the controller. This alarm occurs when the encoder ID is different from the registered contents of the controller. By resetting this alarm, the encoder ID is registered (paired) to the controller again.

When a controller is changed after pairing is completed				
	Encoder ID no. (* Numbers below are examples.)			
Actuator	17623	17623	17623	17623
Controller	17623	17699	17699	17623
ID mismatch error occurred?	No	Yes	Yes	Error reset ⇒ No

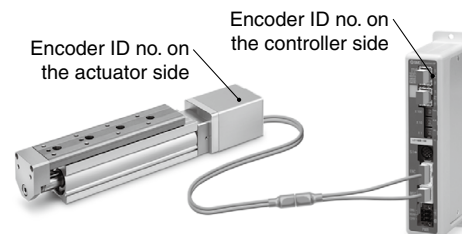

The ID number is automatically checked when the control power supply is turned ON. An error is output if the ID number does not match.

- In environments where strong magnetic fields are present, use may be limited.**

A magnetic sensor is used in the encoder. Therefore, if the actuator motor is used in an environment where strong magnetic fields are present, malfunction or failure may occur. Do not expose the actuator motor to magnetic fields with a magnetic flux density of 1 mT or more. When installing an electric actuator and an air cylinder with an auto switch (e.g. CDQ2 series) or multiple electric actuators side by side, maintain a space of 40 mm or more around the motor. Refer to the construction drawing of the actuator motor.

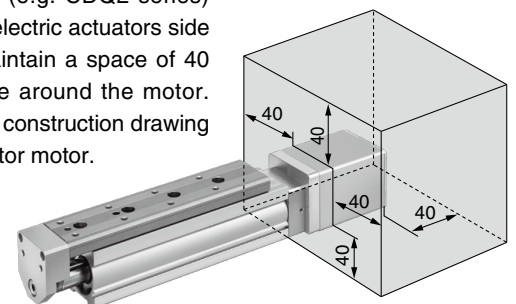

An air cylinder with an auto switch cannot be installed in the shaded area.



LESYH□G Series Specific Product Precautions 2

Be sure to read this before handling the products. Refer to the back cover for safety instructions. For electric actuator and auto switch precautions, refer to the “Handling Precautions for SMC Products” and the “Operation Manual” on the SMC website: <https://www.smcworld.com>

Handling

⚠ Caution

• When lining up actuators

SMC actuators can be used with their motors adjacent to each other. However, for actuators with a built-in auto switch magnet, maintain a space of 40 mm or more between the motors and the position where the magnet passes.

Refer to the construction drawings in the catalog for the magnet position.

○ Can be used with their motors adjacent to each other

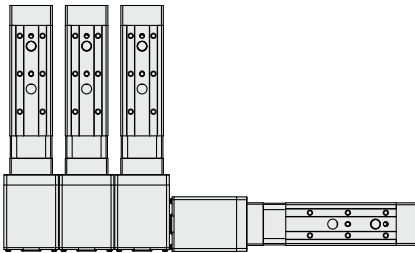
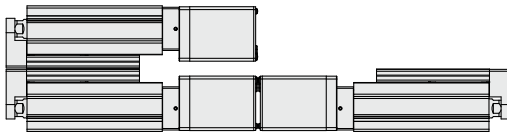

✗ Do not allow the motors to be in close proximity to the position where the magnet passes.

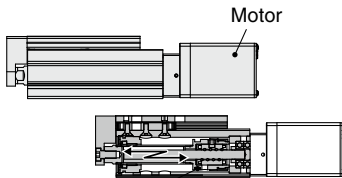

Electric actuator built-in magnet portion (Screw nut)

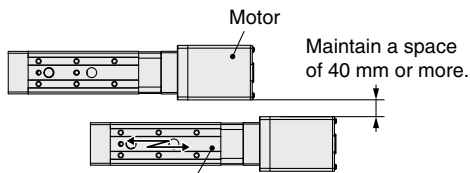

Electric actuator built-in magnet portion (Table unit)

6. The connector size of the motor cable is different from that of the electric actuator with an incremental encoder.

The motor cable connector of an electric actuator with a battery-less absolute encoder is different from that of an electric actuator with an incremental encoder. As the connector cover dimensions are different, take the dimensions below into consideration during the design process.

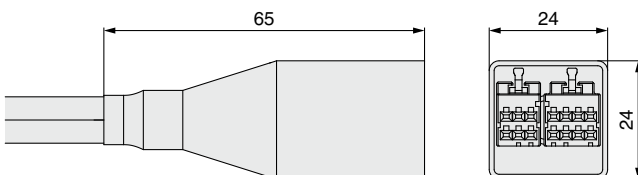

Battery-less absolute encoder connector cover dimensions

7. To conduct a pushing operation, be sure to set the product to [Pushing operation]. Never allow the table to collide with the stroke end except during return to origin.

When incorrect instructions are inputted, such as those which cause the product to operate outside of the specification limits or outside of the actual stroke through changes in the controller/driver settings and/or origin position, the table may collide with the stroke end of the actuator. Be sure to check these points before use.

If the table collides with the stroke end of the actuator, the guide, belt, or internal stopper may break. This can result in abnormal operation.



Handle the actuator with care when it is used in the vertical direction as the workpiece will fall freely from its own weight.

8. The actual speed of this actuator is affected by the load.

Check the model selection section of the catalog.

9. Do not apply a load, impact, or resistance in addition to the transferred load during return to origin.

Additional force will cause the displacement of the origin position.

10. The table and guide block are made of special stainless steel, but can rust in an environment where droplets of water adhere to it.

11. Do not dent, scratch, or cause other damage to the body, table and end plate mounting surfaces.

Doing so may cause unevenness in the mounting surface, play in the guide, or an increase in the sliding resistance.

12. Do not dent, scratch or cause other damage to the surface over which the rail and guide will move.

Doing so may cause play or an increase in the sliding resistance.

13. Do not apply strong impact or an excessive moment while mounting a workpiece.

If an external force over the allowable moment is applied, it may cause play in the guide or an increase in the sliding resistance.

14. Keep the flatness of mounting surface within 0.02 mm.

If a workpiece or base does not sit evenly on the body of the product, play in the guide or an increase in the sliding resistance may occur. Do not deform the mounting surface by mounting with workpieces tucked in.

15. Do not drive the main body with the table fixed.



LESYH□G Series Specific Product Precautions 3

Be sure to read this before handling the products. Refer to the back cover for safety instructions. For electric actuator and auto switch precautions, refer to the “Handling Precautions for SMC Products” and the “Operation Manual” on the SMC website: <https://www.smcworld.com>

Handling

⚠ Caution

16. When mounting the product, use screws of adequate length and tighten them to the max. torque or less.

Tightening the screws with a higher torque than recommended may result in a malfunction, while tightening with a lower torque can result in the displacement of the mounting position or, in extreme conditions, the actuator could become detached from its mounting position.

Body fixed/ Side mounting (Body tapped)

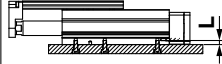

Size	Screw size	Max. tightening torque [N·m]	L (Max. screw-in depth [mm])
8	M4 x 0.7	1.5	5
16	M5 x 0.8	3	6.5
25	M6 x 1	5.2	8.5

Workpiece fixed/Front mounting

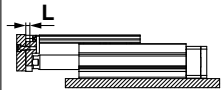

Size	Screw size	Max. tightening torque [N·m]	L [mm]
8	M4 x 0.7	1.5	8
16	M5 x 0.8	3	10
25	M6 x 1	5.2	12

To prevent the workpiece retaining screws from penetrating the end plate, use screws that are 0.5 mm or shorter than the max. screw-in depth. If long screws are used, they may touch the end plate and cause a malfunction.

Workpiece fixed/Top mounting

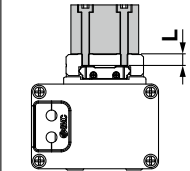

Size	Screw size	Max. tightening torque [N·m]	L [mm]
8	M3 x 0.5	0.63	4.8 (Max.)
16	M5 x 0.8	3	6.5 (Max.)
25	M6 x 1	5.2	8 (Max.)

To prevent the workpiece retaining screws from touching the guide block, use screws that are the max. screw-in depth or less. If long screws are used, they may touch the guide block and cause a malfunction.

17. When external force is to be applied to the table, it is necessary to reduce the work load for the sizing.

When a cable duct or flexible moving tube is attached to the actuator, the sliding resistance of the table will increase, which may lead to the malfunction of the product.

18. Do not grasp or peel off a masking tape on the bottom of the body.

The masking tape may peel off and foreign matter may get inside the actuator.

19. When the table operates, the gap can be done between actuator (marked with the arrow below). Be careful to prevent your hands or fingers from getting caught in the gap.

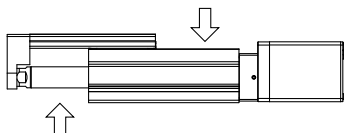

20. Install the body as shown below with the ○.

Since the product support becomes unstable, it may cause a malfunction, noise or an increase in the deflection.

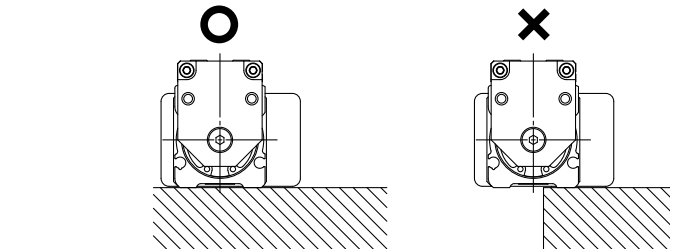
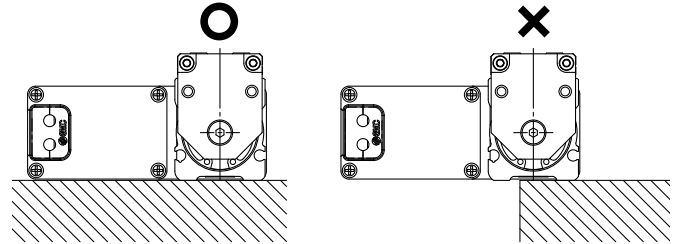

21. Even with the same product number, the table of some products can be moved by hand and the table of some products cannot be moved by hand. However, there is no abnormality with these products. (Without lock)

This difference is caused because there is a little variation with the positive efficiency (when the table is moved by the motor) and there is a large variation with the reverse efficiency (when the table is moved manually) due to the product characteristics. There is hardly any difference among products when they are operated by the motor.



LESYH□G Series Specific Product Precautions 4

Be sure to read this before handling the products. Refer to the back cover for safety instructions. For electric actuator and auto switch precautions, refer to the “Handling Precautions for SMC Products” and the “Operation Manual” on the SMC website: <https://www.smcworld.com>

Maintenance

Warning

1. Ensure that the power supply is stopped before starting maintenance work or replacing the product.
2. For lubrication, wear protective glasses.
3. Perform maintenance according to the following requirements.

Maintenance frequency

Perform maintenance according to the table below.

Frequency	Appearance check	Belt check
Inspection before daily operation	○	—
Inspection every 6 months*1	—	○
Inspection every 250 km*1	—	○
Inspection every 5 million cycles*1	—	○

*1 Select whichever comes first.

• Items for visual appearance check

1. Loose set screws, Abnormal amount of dirt, etc.
2. Check for visible damage, Check of cable joint
3. Vibration, Noise

• Items for belt check (R/L type only)

Stop operation immediately and replace the belt when any of the following occur.

a. Tooth shape canvas is worn out

Canvas fiber becomes fuzzy, Rubber is coming off and the fiber has become whitish, Lines of fibers have become unclear

b. Peeling off or wearing of the side of the belt

Belt corner has become rounded and frayed threads stick out

c. Belt partially cut

Belt is partially cut, Foreign matter caught in the teeth of other parts is causing damage

d. A vertical line on belt teeth is visible

Damage which is made when the belt runs on the flange

e. Rubber back of the belt is softened and sticky

f. Cracks on the back of the belt are visible

Controllers

JXC□ Series



Step Data Input Type p. 33

High Performance

Battery-less Absolute (Step Motor 24 VDC)

JXC5H/6H Series



EtherCAT/EtherNet/IP™/PROFINET Direct Input Type p. 40

High Performance

Battery-less Absolute (Step Motor 24 VDC)

JXC□H Series

EtherCAT®

EtherNet/IP®

PROFINET®



• Actuator Cable p. 45

Model Selection

LESYH□G Series

Auto Switch

JXC5H/6H Series

JXCEH/9H/PH Series

Specific Product Precautions

High Performance Controller (Step Data Input Type)

JXC5H/6H Series



How to Order

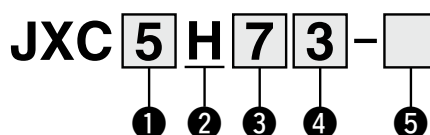

1 Controller type

5	Parallel I/O (NPN) type
6	Parallel I/O (PNP) type

2 Specification

H	High performance type
---	-----------------------

3 Mounting

7	Screw mounting
8	DIN rail

4 I/O cable length

Nil	None
1	1.5 m
3	3 m
5	5 m

5 Actuator part number

Without cable specifications and actuator options Example: Enter "LESYH16RGA-50" for the LESYH16RGA-50C-R1□.	
BC	Blank controller*1

*1 Requires dedicated software (JXC-BCW)

The controller is sold as single unit after the compatible actuator is set.

Connect to an actuator (LESYH□G) designated for a high performance controller. Confirm that the combination of the controller and actuator is correct.

<Check the following before use.>

Check the actuator label for the model number. This number should match that of the controller.

LESYH16RGA-50



⚠ Caution

[CE/UKCA-compliant products]

EMC compliance was tested by combining the electric actuator LE series and the JXC5H/6H series.

The EMC depends on the configuration of the customer's control panel and the relationship with other electrical equipment and wiring.

Therefore, compliance with the EMC directive cannot be certified for SMC components incorporated into the customer's equipment under actual operating conditions. As a result, it is necessary for the customer to verify compliance with the EMC directive for the machinery and equipment as a whole.

* Refer to the operation manual for using the products. Please download it via our website: <https://www.smcworld.com>

Specifications

Model	JXC5H JXC6H
Compatible motor	Step motor (Servo/24 VDC)
Power supply	Power supply voltage: 24 VDC ±10%
Current consumption (Controller)	100 mA or less
Compatible encoder	Battery-less absolute encoder
Parallel input	11 inputs (Photo-coupler isolation)
Parallel output	13 outputs (Photo-coupler isolation)
Serial communication	RS485 (Only for the LEC-T1 and JXC-W2)
Memory	EEPROM
LED indicator	PWR, ALM
Cable length [m]	Actuator cable: 20 or less
Cooling system	Natural air cooling
Operating temperature range [°C]	0 to 40
Operating humidity range [%RH]	90 or less (No condensation)
Insulation resistance [MΩ]	Between all external terminals and the case: 50 (500 VDC)
Weight [g]	180 (Screw mounting), 200 (DIN rail mounting)

How to Mount

a) Screw mounting (JXC□H7□) (Installation with two M4 screws)

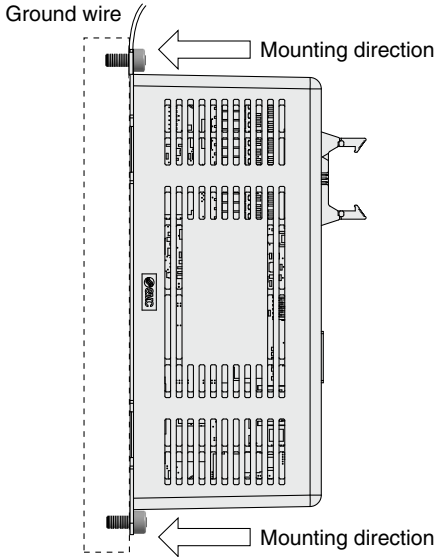

b) DIN rail mounting (JXC□H8□) (Installation with the DIN rail)

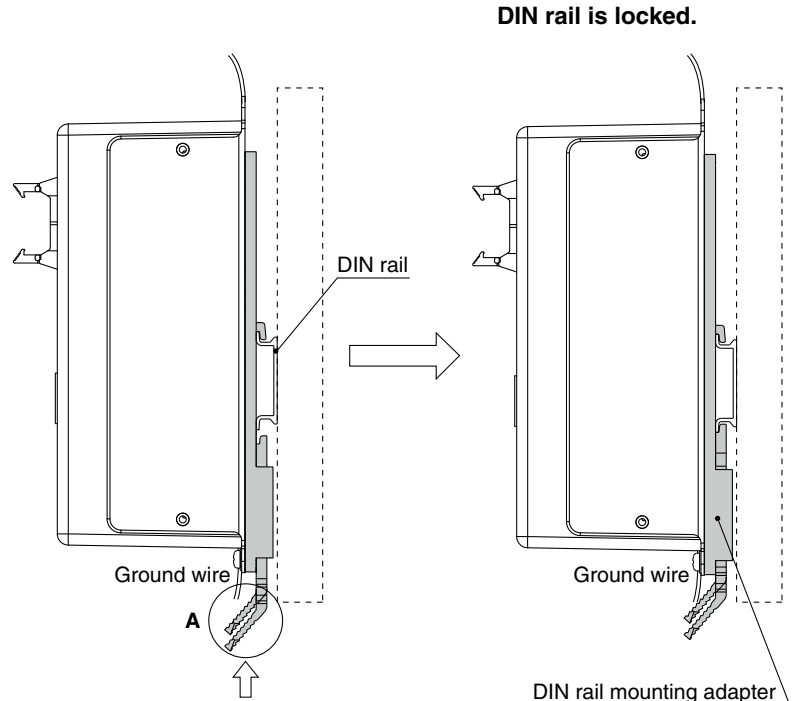

Hook the controller on the DIN rail and press the lever of section A in the arrow direction to lock it.

* When size 25 or more of the LE series are used, the space between the controllers should be 10 mm or more.

DIN rail AXT100-DR-□

* For □, enter a number from the No. line in the table below.
Refer to the dimension drawings on page 35 for the mounting dimensions.

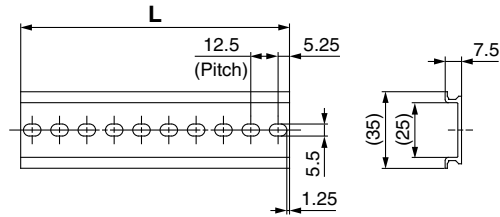

L Dimensions [mm]

No.	1	2	3	4	5	6	7	8	9	10	11	12	13	14	15	16	17	18	19	20
L	23	35.5	48	60.5	73	85.5	98	110.5	123	135.5	148	160.5	173	185.5	198	210.5	223	235.5	248	260.5
No.	21	22	23	24	25	26	27	28	29	30	31	32	33	34	35	36	37	38	39	40
L	273	285.5	298	310.5	323	335.5	348	360.5	373	385.5	398	410.5	423	435.5	448	460.5	473	485.5	498	510.5

DIN rail mounting adapter LEC-D0 (with 2 mounting screws)

This should be used when the DIN rail mounting adapter is mounted onto a screw mounting type controller afterward.

Model Selection

LESYH□G Series

Auto Switch

JXC5H/6H Series

JXCEH/9H/PH Series

Specific Product Precautions

JXC5H/6H Series

Dimensions

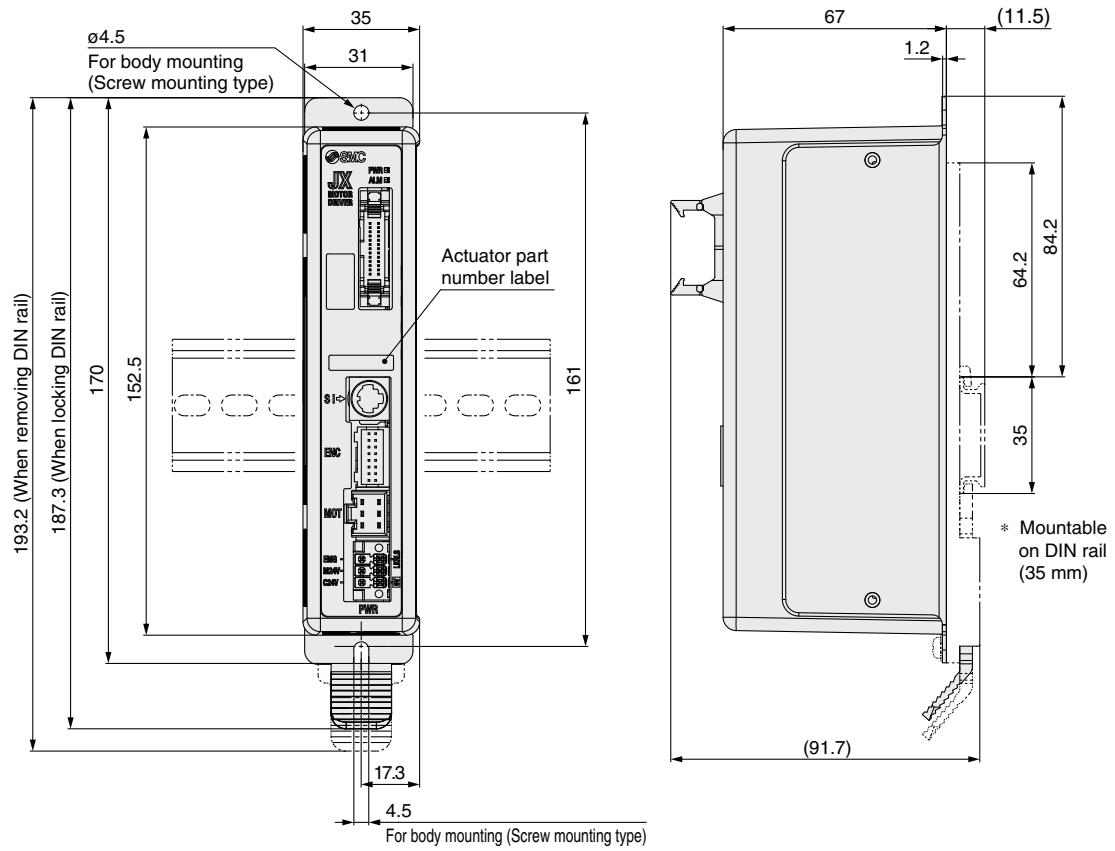

Wiring Example 1

Parallel I/O Connector

- * When you connect a PLC to the parallel I/O connector, use the I/O cable (LEC-CN5-□).
- * The wiring changes depending on the type of parallel I/O (NPN or PNP).

Wiring diagram JXC5H□□ (NPN)

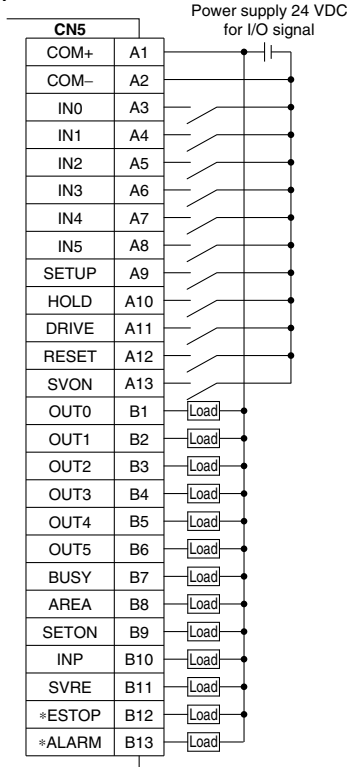

JXC6H□□ (PNP)

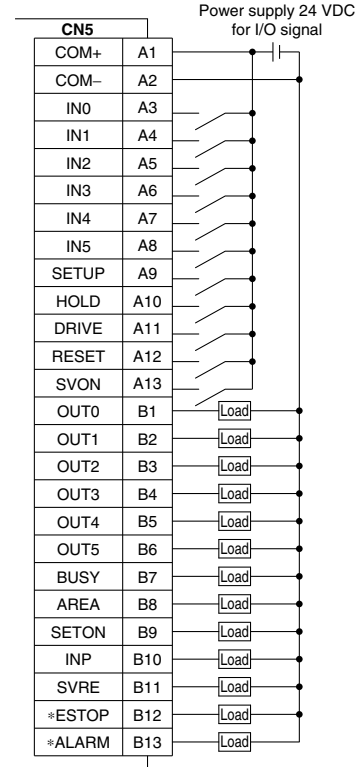

Input Signal

Name	Details
COM+	Connects the power supply 24 V for input/output signal
COM-	Connects the power supply 0 V for input/output signal
IN0 to IN5	Step data specified bit no. (Input is instructed by combining IN0 to 5.)
SETUP	Instruction to return to origin
HOLD	Temporarily stops operation
DRIVE	Instruction to drive
RESET	Resets alarm and interrupts operation
SVON	Servo ON instruction

Output Signal

Name	Details
OUT0 to OUT5	Outputs the step data no. during operation
BUSY	Outputs when the actuator is moving
AREA	Outputs within the step data area output setting range
SETON	Outputs when returning to origin
INP	Outputs when target position or target force is reached (Turns on when the positioning or pushing is completed.)
SVRE	Outputs when servo is on
ESTOP ¹	OFF when EMG stop is instructed
ALARM ¹	OFF when alarm is generated

*¹ Signal of negative-logic circuit (N.C.)

Model Selection

LESYH□G Series

Auto Switch

JXC5H/6H Series

JXCEH/9H/PH Series

Specific Product Precautions

Step Data Setting

1. Step data setting for positioning

In this setting, the actuator moves toward and stops at the target position.

The following diagram shows the setting items and operation. The setting items and set values for this operation are stated below.

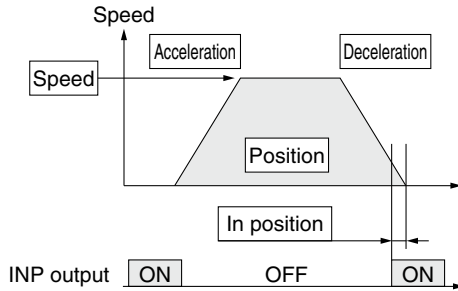

◎ : Need to be set.
○ : Need to be adjusted as required.
— : Setting is not required.

Step Data (Positioning)

Necessity	Item	Details
◎	Movement MOD	When the absolute position is required, set Absolute. When the relative position is required, set Relative.
◎	Speed	Transfer speed to the target position
◎	Position	Target position
○	Acceleration	Parameter which defines how rapidly the actuator reaches the speed set. The higher the set value, the faster it reaches the speed set.
○	Deceleration	Parameter which defines how rapidly the actuator comes to stop. The higher the set value, the quicker it stops.
◎	Pushing force	Set 0. (If values 1 to 100 are set, the operation will be changed to the pushing operation.)
—	Trigger LV	Setting is not required.
—	Pushing speed	Setting is not required.
○	Moving force	Max. torque during the positioning operation (No specific change is required.)
○	Area 1, Area 2	Condition that turns on the AREA output signal.
○	In position	Condition that turns on the INP output signal. When the actuator enters the range of [in position], the INP output signal turns on. (It is unnecessary to change this from the initial value.) When it is necessary to output the arrival signal before the operation is completed, make the value larger.

2. Step data setting for pushing

The actuator moves toward the pushing start position, and when it reaches that position, it starts pushing with the set force or less.

The following diagram shows the setting items and operation. The setting items and set values for this operation are stated below.

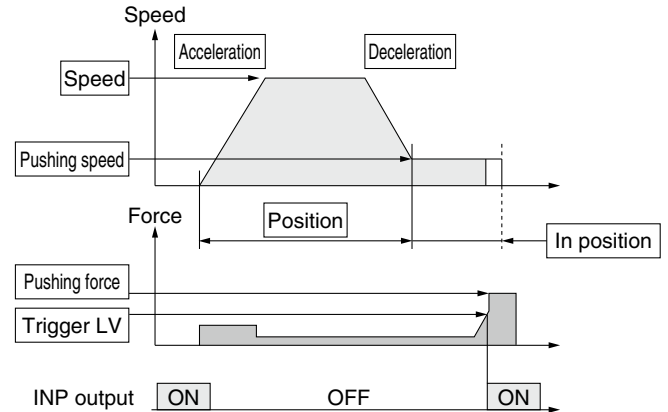

◎ : Need to be set.
○ : Need to be adjusted as required.

Step Data (Pushing)

Necessity	Item	Details
◎	Movement MOD	When the absolute position is required, set Absolute. When the relative position is required, set Relative.
◎	Speed	Transfer speed to the pushing start position
◎	Position	Pushing start position
○	Acceleration	Parameter which defines how rapidly the actuator reaches the speed set. The higher the set value, the faster it reaches the speed set.
○	Deceleration	Parameter which defines how rapidly the actuator comes to stop. The higher the set value, the quicker it stops.
◎	Pushing force	Pushing force ratio is defined. The setting range differs depending on the electric actuator type. Refer to the operation manual for the electric actuator.
◎	Trigger LV	Condition that turns on the INP output signal. The INP output signal turns on when the generated force exceeds the value. Trigger level should be the pushing force or less.
○	Pushing speed	Pushing speed during pushing. When the speed is set fast, the electric actuator and workpieces might be damaged due to the impact when they hit the end, so this set value should be smaller. Refer to the operation manual for the electric actuator.
○	Moving force	Max. torque during the positioning operation (No specific change is required.)
○	Area 1, Area 2	Condition that turns on the AREA output signal.
◎	In position	Transfer distance during pushing. If the transferred distance exceeds the setting, it stops even if it is not pushing. If the transfer distance is exceeded, the INP output signal will not turn on.

Signal Timing

Return to Origin

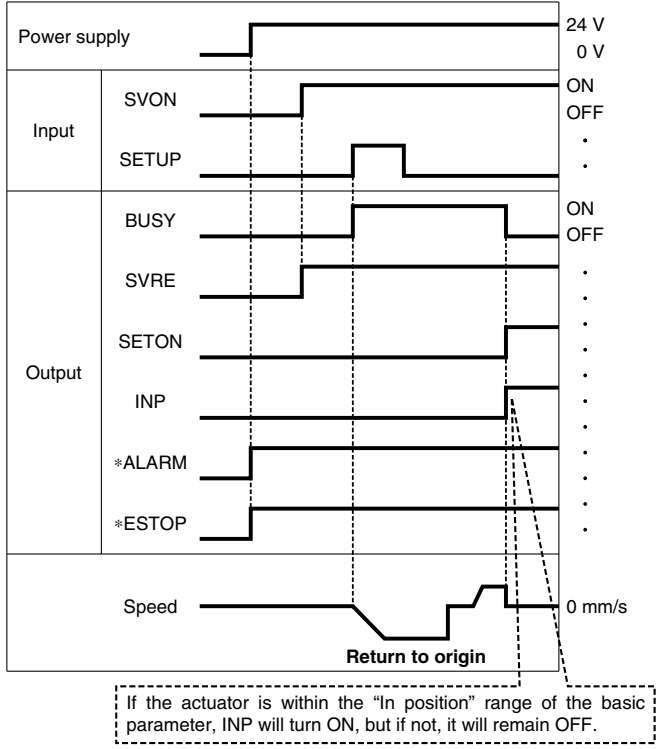

* *ALARM" and *ESTOP" are expressed as negative-logic circuits.

Positioning Operation

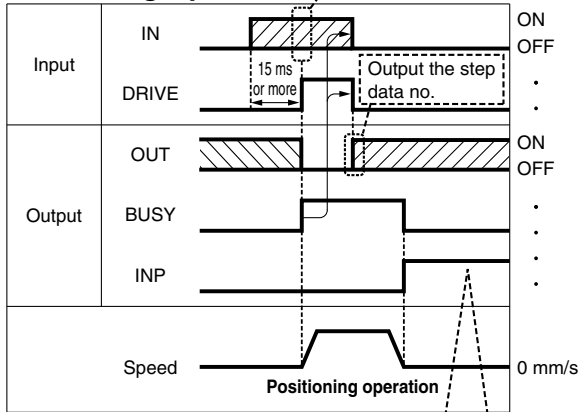

* "OUT" is output when "DRIVE" is changed from ON to OFF. Refer to the operation manual for details on the controller for the LEM series. (When power supply is applied, "DRIVE" or "RESET" is turned ON or *ESTOP" is turned OFF, all of the "OUT" outputs are OFF.)

HOLD

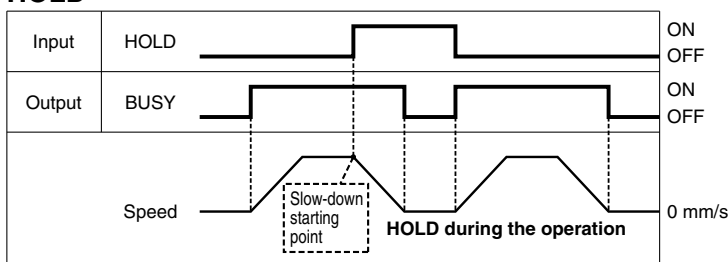

* When the actuator is within the "In position" range in the pushing operation, it does not stop even if HOLD signal is input.

Pushing Operation

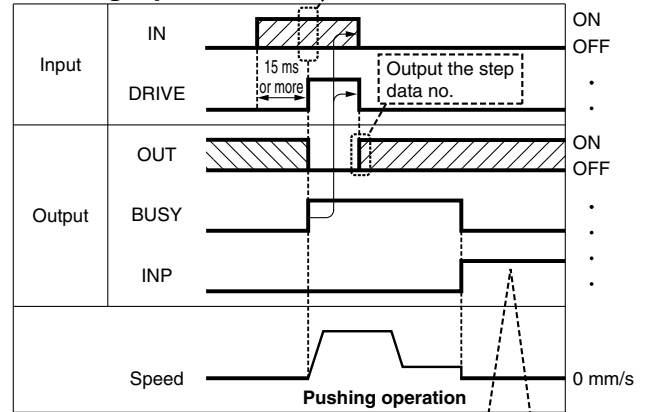

Reset

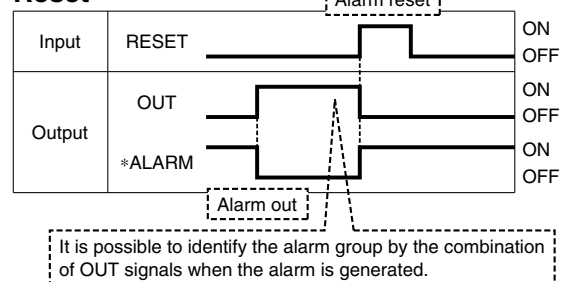

* *ALARM" is expressed as a negative-logic circuit.

Model Selection

LESYH□G Series

Auto Switch

JXC5H/6H Series

JXCEH/9H/PH Series

Specific Product Precautions

JXC5H/6H Series

Options

■ Communication cable for controller setting

① Communication cable JXC-W2A-C

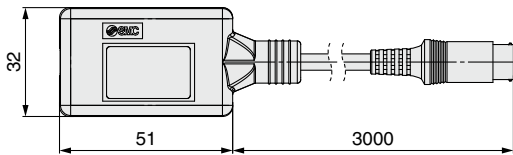

* It can be connected to the controller directly.

② USB cable LEC-W2-U

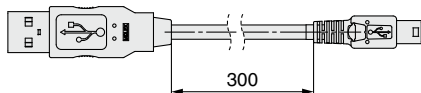

③ Controller setting kit JXC-W2A

A set which includes a communication cable (JXC-W2A-C) and a USB cable (LEC-W2-U)

<Controller setting software/USB driver>

- Controller setting software
 - USB driver (For JXC-W2A-C)
- Download from SMC's website:
<https://www.smcworld.com>

Hardware Requirements

OS	Windows®7, Windows®8.1, Windows®10
Communication interface	USB 1.1 or USB 2.0 ports
Display	1024 x 768 or more

* Windows®7, Windows®8.1, and Windows®10 are registered trademarks of Microsoft Corporation in the United States.

■ Conversion cable P5062-5 (Cable length: 300 mm)

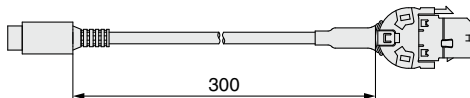

* To connect the teaching box (LEC-T1-3□J□G□) or controller setting kit (LEC-W2□) to the controller, a conversion cable is required.

■ I/O cable

LEC-CN5-1

Cable length (L) [m]	
1	1.5
3	3
5	5

* Conductor size: AWG28

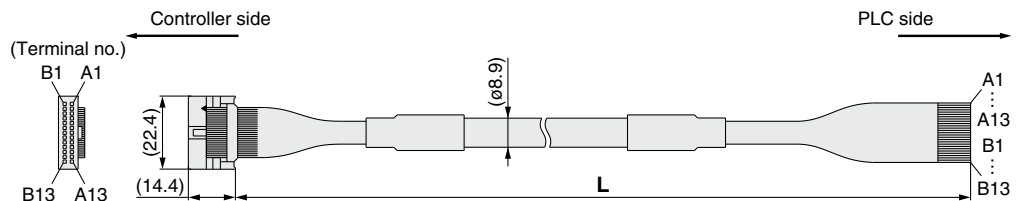

Connector pin no.	Insulation color	Dot mark	Dot color
A1	Light brown	■	Black
A2	Light brown	■	Red
A3	Yellow	■	Black
A4	Yellow	■	Red
A5	Light green	■	Black
A6	Light green	■	Red
A7	Gray	■	Black
A8	Gray	■	Red
A9	White	■	Black
A10	White	■	Red
A11	Light brown	■ ■	Black
A12	Light brown	■ ■	Red
A13	Yellow	■ ■	Black

Connector pin no.	Insulation color	Dot mark	Dot color
B1	Yellow	■ ■	Red
B2	Light green	■ ■	Black
B3	Light green	■ ■	Red
B4	Gray	■ ■	Black
B5	Gray	■ ■	Red
B6	White	■ ■	Black
B7	White	■ ■	Red
B8	Light brown	■ ■ ■	Black
B9	Light brown	■ ■ ■	Red
B10	Yellow	■ ■ ■	Black
B11	Yellow	■ ■ ■	Red
B12	Light green	■ ■ ■	Black
B13	Light green	■ ■ ■	Red
—			Shield

Weight

Product no.	Weight [g]
LEC-CN5-1	170
LEC-CN5-3	320
LEC-CN5-5	520

■ Power supply plug JXC-CPW

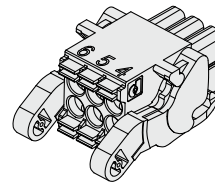

* The power supply plug is an accessory.
 <Applicable cable size> AWG20 (0.5 mm²), cover diameter 2.0 mm or less

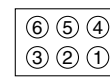

- ① C24V
- ② M24V
- ③ EMG
- ④ 0V
- ⑤ N.C.
- ⑥ LK RLS

Power supply plug

Terminal name	Function	Details
0V	Common supply (-)	The M24V terminal, C24V terminal, EMG terminal, and LK RLS terminal are common (-).
M24V	Motor power supply (+)	Motor power supply (+) of the controller
C24V	Control power supply (+)	Control power supply (+) of the controller
EMG	Stop (+)	Connection terminal of the external stop circuit
LK RLS	Lock release (+)	Connection terminal of the lock release switch

■ Teaching box

LEC-T1-3□J□G□

Teaching box

Cable length [m]
 3 3

Initial language

J	Japanese
E	English

* The displayed language can be changed to English or Japanese.

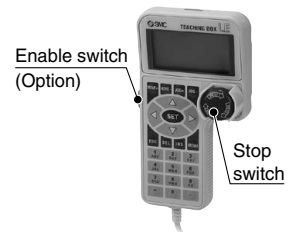

Enable switch

Nil	None
S	Equipped with enable switch

* Interlock switch for jog and test function

Stop switch

G	Equipped with stop switch
---	---------------------------

Specifications

Item	Description
Switch	Stop switch, Enable switch (Option)
Cable length [m]	3
Enclosure	IP64 (Except connector)
Operating temperature range [°C]	5 to 50
Operating humidity range [%RH]	90 or less (No condensation)
Weight [g]	350 (Except cable)

High Performance Step Motor Controller

JXCEH/9H/PH Series



Model Selection

How to Order

⚠ Caution

[CE/UKCA-compliant products]

① EMC compliance was tested by combining the electric actuator LE series and the JXCEH/PH series.

The EMC depends on the configuration of the customer's control panel and the relationship with other electrical equipment and wiring. Therefore, compliance with the EMC directive cannot be certified for SMC components incorporated into the customer's equipment under actual operating conditions. As a result, it is necessary for the customer to verify compliance with the EMC directive for the machinery and equipment as a whole.

② For the JXCEH/PH series (step motor controller), EMC compliance was tested by installing a noise filter set (LEC-NFA).

Refer to page 44 for the noise filter set. Refer to the JXCEH/PH Operation Manual for installation.

JXC **P** **H** **7** - []

Communication protocol

E	EtherCAT
9	EtherNet/IP™
P	PROFINET

High performance

Mounting

7	Screw mounting
8 *1	DIN rail

*1 The DIN rail is not included. It must be ordered separately. (Refer to page 44.)



EtherCAT EtherNet/IP PROFINET

Actuator part number

Without cable specifications and actuator options
Example: Enter "LESYH16RGA-50C"
for the LESYH16RGA-50C-S1□□.

BC Blank controller*1

*1 Requires dedicated software (JXC-BCW)

LESYH□G Series

Auto Switch

JXC5H/6H Series

JXCEH/9H/PH Series

Specific Product Precautions

The controller is sold as single unit after the compatible actuator is set.

Confirm that the combination of the controller and actuator is correct.

① Check the actuator label for the model number. This number should match that of the controller.

LESYH16RGA-50

①



* Refer to the operation manual for using the products. Please download it via our website: <https://www.smcworld.com>

Precautions for blank controllers (JXC□H□-BC)

A blank controller is a controller to which the customer can write the data of the actuator it is to be combined and used with. Use the dedicated software (JXC-BCW) for data writing.

- Please download the dedicated software (JXC-BCW) via our website.
- Order the communication cable for controller setting (JXC-W2A-C) and USB cable (LEC-W2-U) separately to use this software.

SMC website: <https://www.smcworld.com>

JXCEH/9H/PH Series

Specifications

Model		JXCEH	JXC9H	JXCPH	
Network		EtherCAT	EtherNet/IP™	PROFINET	
Compatible motor		Step motor (Servo/24 VDC)			
Power supply		Power voltage: 24 VDC ±10%			
Current consumption (Controller)		200 mA or less	200 mA or less	200 mA or less	
Compatible encoder		Battery-less absolute encoder			
Communication specifications	Applicable system	Protocol	EtherCAT*2	EtherNet/IP™*2	PROFINET*2
		Version*1	Conformance Test Record V.1.2.6	Volume 1 (Edition 3.14) Volume 2 (Edition 1.15)	Specification Version 2.32
	Communication speed	100 Mbps*2	10/100 Mbps*2 (Automatic negotiation)	100 Mbps*2	
	Configuration file*3	ESI file	EDS file	GSDML file	
	I/O occupation area	Input 20 bytes Output 36 bytes	Input 36 bytes Output 36 bytes	Input 36 bytes Output 36 bytes	
Terminating resistor		Not included			
Memory		EEPROM			
LED indicator		PWR, RUN, ALM, ERR	PWR, ALM, MS, NS	PWR, ALM, SF, BF	
Cable length [m]		Actuator cable: 20 or less			
Cooling system		Natural air cooling			
Operating temperature range [°C]		0 to 40 (No freezing)*4			
Operating humidity range [%RH]		90 or less (No condensation)			
Insulation resistance [MΩ]		Between all external terminals and the case: 50 (500 VDC)			
Weight [g]		260 (Screw mounting) 280 (DIN rail mounting)	250 (Screw mounting) 270 (DIN rail mounting)	260 (Screw mounting) 280 (DIN rail mounting)	

*1 Please note that versions are subject to change.

*2 Use a shielded communication cable with CAT5 or higher for the PROFINET, EtherNet/IP™, and EtherCAT.

*3 The files can be downloaded from the SMC website.

*4 The operating temperature range for both controller version 1 products and controller version 2 products is 0 to 40°C. Refer to the **Web Catalog** for details on identifying controller version symbols.

■ Trademark

EtherNet/IP® is a registered trademark of ODVA, Inc.

EtherCAT® is registered trademark and patented technology, licensed by Beckhoff Automation GmbH, Germany.

Example of Operation Command

In addition to the step data input of 64 points max. in each communication protocol, the changing of each parameter can be performed in real time via numerical data defined operation.

* Numerical values other than "Moving force," "Area 1," and "Area 2" can be used to perform operation under numerical instructions from JXCL1.

<Application example> Movement between 2 points

No.	Movement mode	Speed	Position	Acceleration	Deceleration	Pushing force	Trigger LV	Pushing speed	Moving force	Area 1	Area 2	In position
0	1: Absolute	100	10	3000	3000	0	0	0	100	0	0	0.50
1	1: Absolute	100	100	3000	3000	0	0	0	100	0	0	0.50

<Step no. defined operation>

Sequence 1: Servo ON instruction

Sequence 2: Instruction to return to origin

Sequence 3: Specify step data No. 0 to input the DRIVE signal.

Sequence 4: Specify step data No. 1 after the DRIVE signal has been temporarily turned OFF to input the DRIVE signal.

<Numerical data defined operation>

Sequence 1: Servo ON instruction

Sequence 2: Instruction to return to origin

Sequence 3: Specify step data No. 0 and turn ON the input instruction flag (position). Input 10 in the target position. Subsequently the start flag turns ON.

Sequence 4: Turn ON step data No. 0 and the input instruction flag (position) to change the target position to 100 while the start flag is ON.

The same operation can be performed with any operation command.

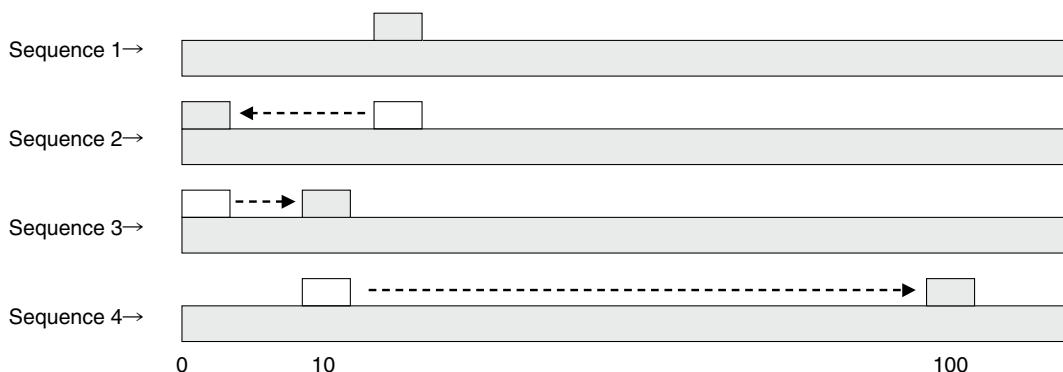

Dimensions

JXCEH

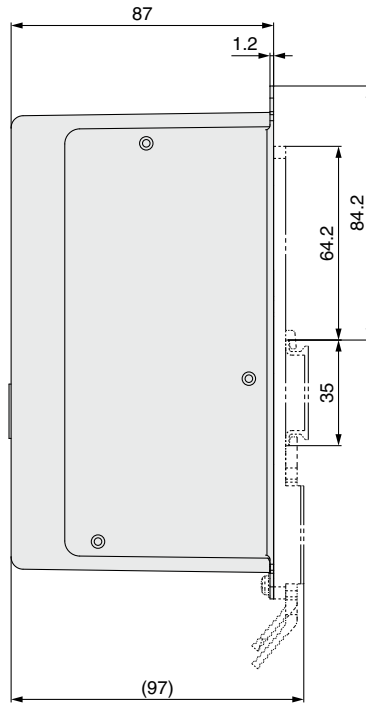
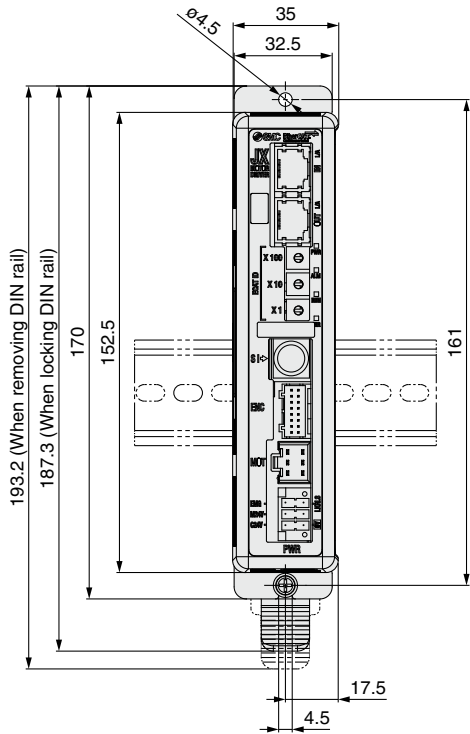

JXC9H

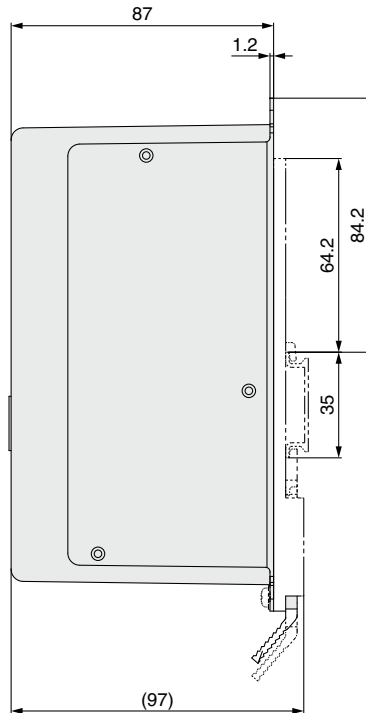
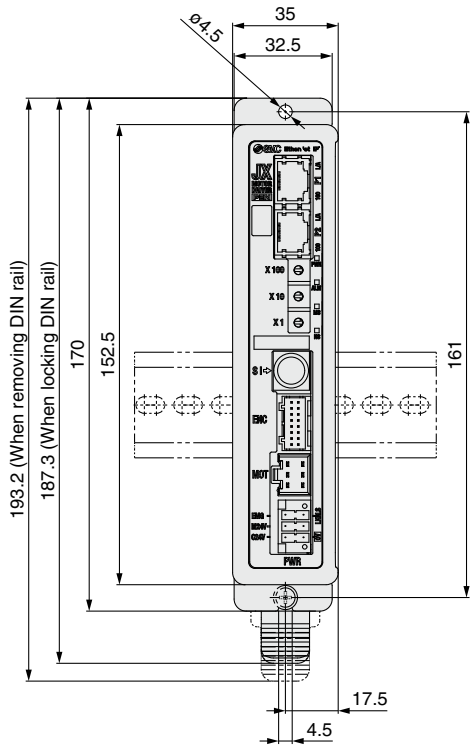

Model Selection

LESYH□G Series

Auto Switch

JXC5H/6H Series

JXCEH/9H/PH Series

Specific Product Precautions

JXCEH/9H/PH Series

Dimensions

JXCPH

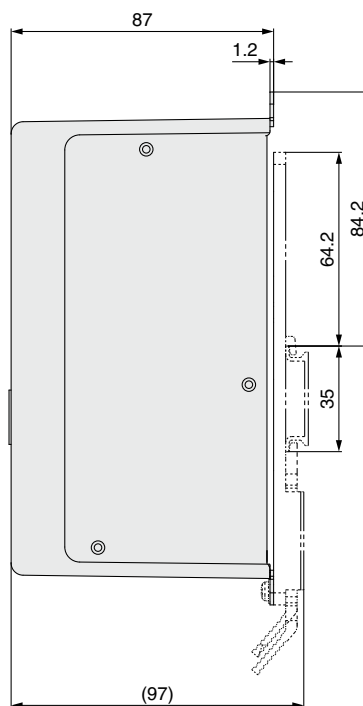
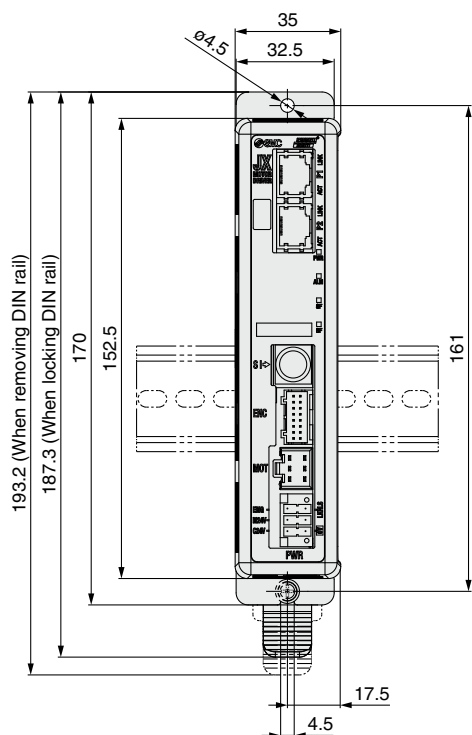

DIN rail

AXT100-DR-□

* For □, enter a number from the No. line in the table below.

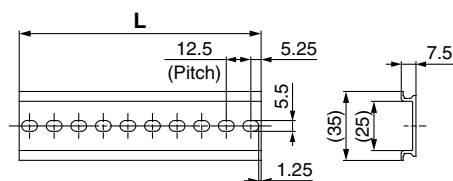

L Dimensions [mm]

No.	1	2	3	4	5	6	7	8	9	10	11	12	13	14	15	16	17	18	19	20
L	23	35.5	48	60.5	73	85.5	98	110.5	123	135.5	148	160.5	173	185.5	198	210.5	223	235.5	248	260.5
No.	21	22	23	24	25	26	27	28	29	30	31	32	33	34	35	36	37	38	39	40
L	273	285.5	298	310.5	323	335.5	348	360.5	373	385.5	398	410.5	423	435.5	448	460.5	473	485.5	498	510.5

Options

■ Communication cable for controller setting

① Communication cable JXC-W2A-C

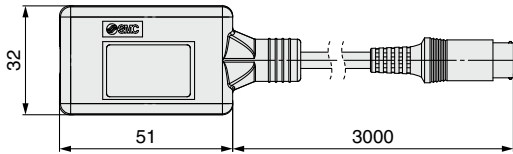

* It can be connected to the controller directly.

② USB cable LEC-W2-U

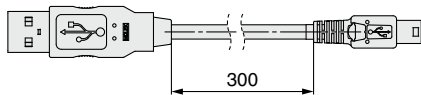

<Controller setting software/USB driver>

- Controller setting software
- USB driver (For JXC-W2A-C)

Download from SMC's website: <https://www.smcworld.com>

Hardware Requirements

OS	Windows®7, Windows®8.1, Windows®10
Communication interface	USB 1.1 or USB 2.0 ports
Display	1024 x 768 or more

* Windows®7, Windows®8.1 and Windows®10 are registered trademarks of Microsoft Corporation in the United States.

■ DIN rail mounting adapter LEC-3-D0

* With 2 mounting screws

This should be used when the DIN rail mounting adapter is mounted onto a screw mounting type controller afterward.

■ DIN rail AXT100-DR-□

* For □, enter a number from the No. line in the table on page 43. Refer to the dimension drawings on pages 42 and 43 for the mounting dimensions.

■ Teaching box

LEC-T1-3 J G □

Teaching box

Cable length [m]

3 3

Initial language

J	Japanese
E	English

* The displayed language can be changed to English or Japanese.

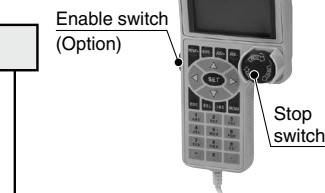

● Enable switch

Nil	None
S	Equipped with enable switch

* Interlock switch for jog and test function

● Stop switch

G	Equipped with stop switch
---	---------------------------

Specifications

Item	Description
Switch	Stop switch, Enable switch (Option)
Cable length [m]	3
Enclosure	IP64 (Except connector)
Operating temperature range [°C]	5 to 50
Operating humidity range [%RH]	90 or less (No condensation)
Weight [g]	350 (Except cable)

■ Power supply plug JXC-CPW

* The power supply plug is an accessory.

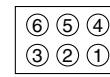
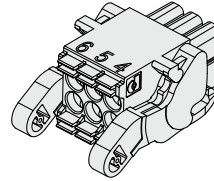

- | | |
|--------|----------|
| ① C24V | ④ 0V |
| ② M24V | ⑤ N.C. |
| ③ EMG | ⑥ LK RLS |

Power supply plug

Terminal name	Function	Details
0V	Common supply (-)	The M24V terminal, C24V terminal, EMG terminal, and LK RLS terminal are common (-).
M24V	Motor power supply (+)	Motor power supply (+) of the controller
C24V	Control power supply (+)	Control power supply (+) of the controller
EMG	Stop (+)	Connection terminal of the external stop circuit
LK RLS	Lock release (+)	Connection terminal of the lock release switch

■ Conversion cable P5062-5 (Cable length: 300 mm)

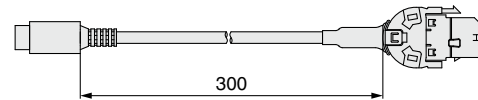

* To connect the teaching box (LEC-T1-3□G□) or controller setting kit (LEC-W2) to the controller, a conversion cable is required.

■ Noise filter set

LEC-NFA

Contents of the set: 2 noise filters

(Manufactured by WURTH ELEKTRONIK: 74271222)

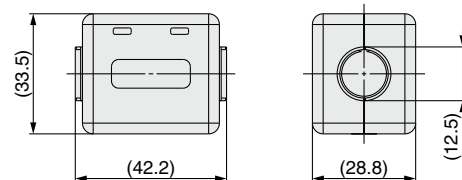

* Refer to the JXCEH/PH series Operation Manual for installation.

JXC5H/6H Series JXCEH/9H/PH Series Actuator Cable (Option)

[Robotic cable for battery-less absolute (Step motor 24 VDC)]

LE-CE-1

Cable length (L) [m]

1	1.5
3	3
5	5
8	8*1
A	10*1
B	15*1
C	20*1

*1 Produced upon receipt of order

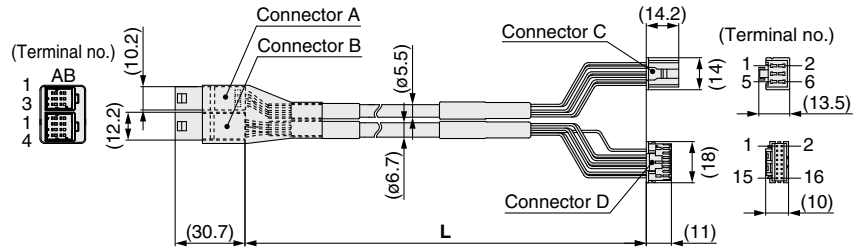

Weight

Product no.	Weight [g]	Note
LE-CE-1	190	Robotic cable
LE-CE-3	360	
LE-CE-5	570	
LE-CE-8	900	
LE-CE-A	1120	
LE-CE-B	1680	
LE-CE-C	2210	

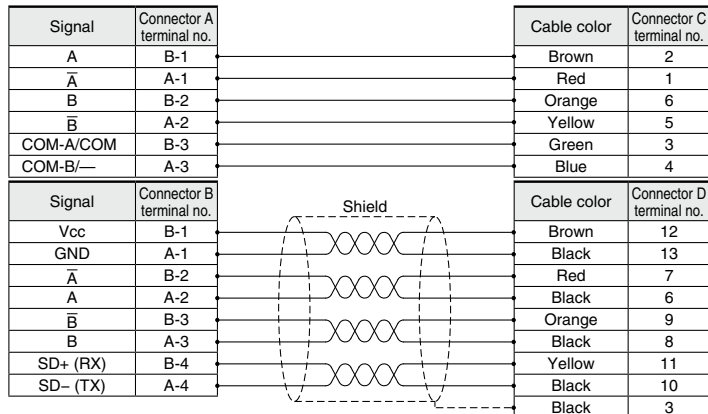

[Robotic cable with lock for battery-less absolute (Step motor 24 VDC)]

LE-CE-1-B

Cable length (L) [m]

1	1.5
3	3
5	5
8	8*1
A	10*1
B	15*1
C	20*1

*1 Produced upon receipt of order

With lock and sensor

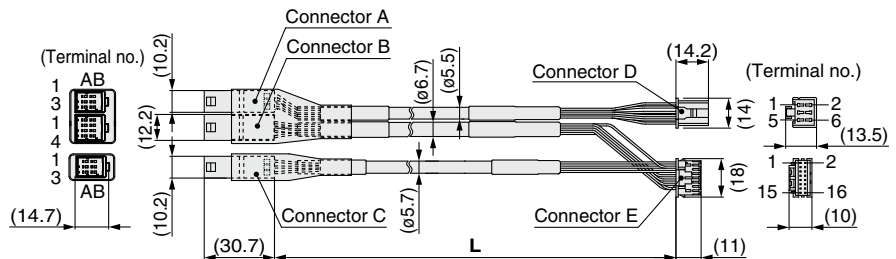

Weight

Product no.	Weight [g]	Note
LE-CE-1-B	240	Robotic cable
LE-CE-3-B	460	
LE-CE-5-B	740	
LE-CE-8-B	1170	
LE-CE-A-B	1460	
LE-CE-B-B	2120	
LE-CE-C-B	2890	

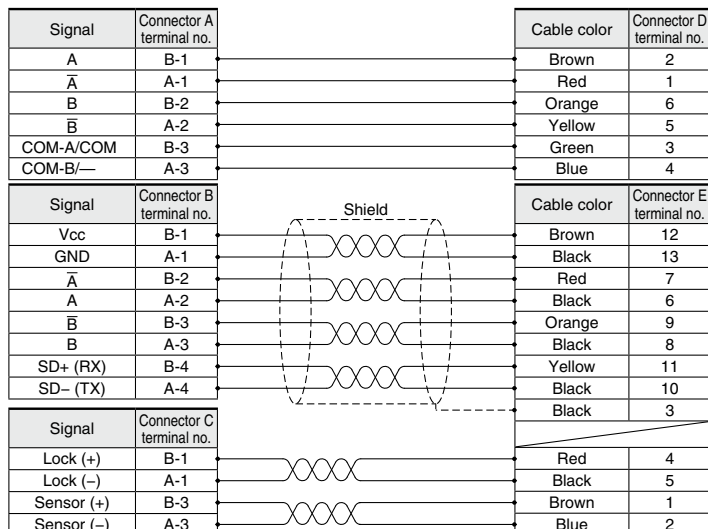



JXC□1/JXC□F/JXC□H Series

Precautions Relating to Differences in Controller Versions

As the controller version of the JXC series differs, the internal parameters are not compatible.

- If using the JXC□1□-BC, please use the latest version of the JXC-BCW (parameter writing tool).
- There are currently 3 versions available: version 1 products (V1.□ or S1.□), version 2 products (V2.□ or S2.□), and version 3 products (V3.□ or S3.□). Keep in mind that in order to write a backup file (.bcp) to another controller with the JXC-BCW, it needs to be the same version as the controller that created the file. (For example, a backup file created by a version 1 product can only be written to another version 1 product, and so on.)

Identifying Version Symbols

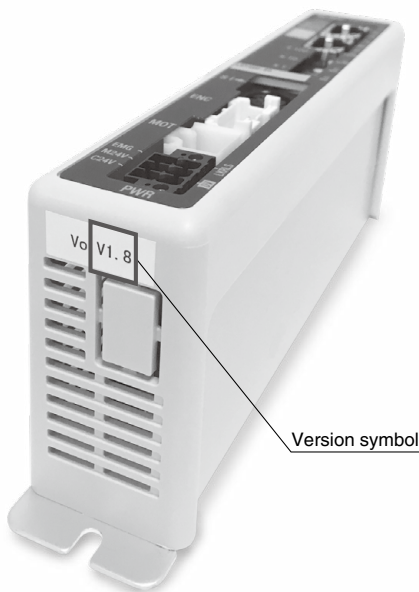

JXC□□ Series Version V3.□ or S3.□ Products

XR V3.0

Applicable models
JXC91 Series

XR S3.0 T1.0

Applicable models
JXC51 Series
JXC61 Series
JXCE□ Series
JXCP1 Series
JXCD1 Series
JXCL□ Series
JXCM1 Series

JXC□□ Series Version V2.□ or S2.□ Products

WP V2.1

Applicable models
JXC91 Series

WP S2.2 T1.1

Applicable models
JXCE□ Series
JXCP1 Series
JXCD1 Series
JXCL□ Series

JXC□□ Series Version V1.□ or S1.□ Products

XR V1.0

Applicable models
JXC91 Series

XR S1.0 T1.0

Applicable models
JXCE□ Series
JXCP□ Series
JXCD1 Series
JXCL□ Series
JXC5H Series
JXC6H Series

Model Selection

LESYH□G Series

Auto Switch

JXC5H/6H Series

JXCEH/9H/PH Series

Specific Product Precautions

JXC□H Series

Blank Controller Versions and Applicable Battery-less Absolute Type Electric Actuator Sizes

- The applicable battery-less absolute type electric actuator size range differs depending on the controller version.
Be sure to confirm the controller version before using a blank controller.

Blank Controller Versions/Applicable Electric Actuator Sizes (JXC□H Series)

Blank controller		Applicable electric actuator size				
Series	Controller version	LEFS□G	LEKF□G	LEY□G	LEG	LESYH□G
JXC9H series JXCEH series JXCPH series	All versions	16, 25, 32, 40	25, 32, 40	16, 25, 40	25, 32, 40	8, 16, 25
	Version 1.0	25, 32, 40		25, 40		16, 25
JXC5H/6H series	Version 1.1 or higher	16, 25, 32, 40		16, 25, 40		8, 16, 25



Battery-less Absolute Encoder Type Specific Product Precautions

Be sure to read this before handling the products. Refer to the back cover for safety instructions. For electric actuator precautions, refer to the “Handling Precautions for SMC Products” and the “Operation Manual” on the SMC website: <https://www.smcworld.com>

Handling

⚠ Caution

1. Absolute encoder ID mismatch error at the first connection

In the following cases, an “ID mismatch error” alarm occurs after the power is turned ON. Perform a return to origin operation after resetting the alarm before use.

- When an electric actuator is connected and the power is turned ON for the first time after purchase*1
- When the actuator or motor is replaced
- When the controller is replaced

*1 If you have purchased an electric actuator and controller with the set part number, the pairing may have already been completed and the alarm may not be generated.

“ID mismatch error”

Operation is enabled by matching the encoder ID on the electric actuator side with the ID registered in the controller. This alarm occurs when the encoder ID is different from the registered contents of the controller. By resetting this alarm, the encoder ID is registered (paired) to the controller again.

When a controller is changed after pairing is completed				
	Encoder ID no. (* Numbers below are examples.)			
Actuator	17623	17623	17623	17623
Controller	17623	17699	17699	17623
ID mismatch error occurred?	No	Yes	Error reset ⇒ No	

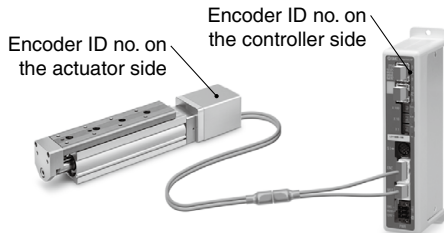

The ID number is automatically checked when the control power supply is turned ON. An error is output if the ID number does not match.

2. In environments where strong magnetic fields are present, use may be limited.

A magnetic sensor is used in the encoder. Therefore, if the actuator motor is used in an environment where strong magnetic fields are present, malfunction or failure may occur. Do not expose the actuator motor to magnetic fields with a magnetic flux density of 1 mT or more.

When installing an electric actuator and an air cylinder with an auto switch (e.g. CDQ2 series) or multiple electric actuators side by side, maintain a space of 40 mm or more around the motor. Refer to the construction drawing of the actuator motor.

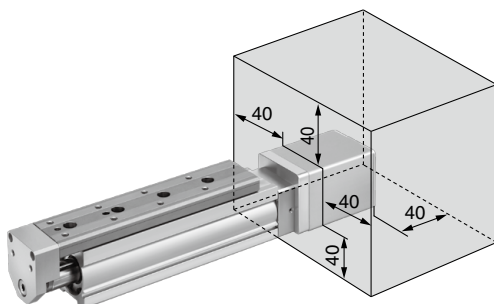

An air cylinder with an auto switch cannot be installed in the shaded area.

• When lining up actuators

SMC actuators can be used with their motors adjacent to each other. However, for actuators with a built-in auto switch magnet, maintain a space of 40 mm or more between the motors and the position where the magnet passes. Refer to the construction drawings in the catalog for the magnet position.

○ Can be used with their motors adjacent to each other

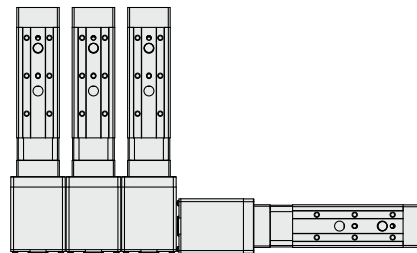
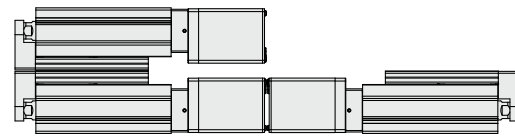

✗ Do not allow the motors to be in close proximity to the position where the magnet passes.

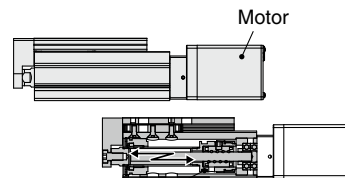

Electric actuator built-in magnet portion (Screw nut)

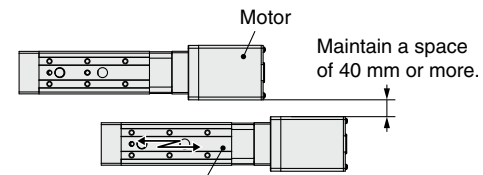

Electric actuator built-in magnet portion (Table unit)

3. The connector size of the motor cable is different from that of the electric actuator with an incremental encoder.

The motor cable connector of an electric actuator with a battery-less absolute encoder is different from that of an electric actuator with an incremental encoder. As the connector cover dimensions are different, take the dimensions below into consideration during the design process.

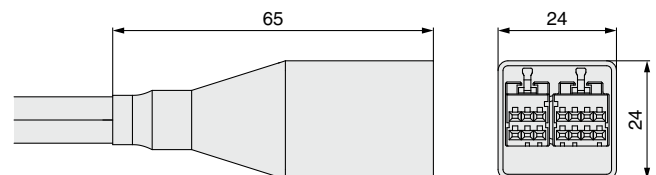

Battery-less absolute encoder connector cover dimensions

CE/UKCA/UL-compliance List

* For CE, UKCA, and UL-compliant products, refer to the tables below and the following pages.

■ Controllers “○”: Compliant “x”: Not compliant

As of February 2022

Compatible motor	Series	CE UKCA		cULus		Compatible motor	Series	CE UKCA		cULus LISTED	
		Compliance	Certification No. (File No.)	Compliance	Certification No. (File No.)			Compliance	Certification No. (File No.)		
Step motor (Servo/24 VDC)	JXCE1	○	○	○	E480340	AC servo motor	LECSA	○	○	○	E466261
	JXC91	○	○	○	E480340		LECSB-T	○	○	○	E466261
	JXCP1	○	○	○	E480340		LECSA-T	○	○	○	E466261
	JXCD1	○	○	○	E480340		LECSN-T	○	○*1	○	E466261
	JXCL1	○	○	○	E480340		LECSS-T	○	○	○	E466261
	JXCM1	○	○	○	E480340		LECYM	○	x	○	—
	LECP1	○	○	○	E339743		LECYU	○	x	○	—
	LECP2	○	○	○	E339743						
	LECPA	○	○	○	E339743						
	JXC51/61	○	○	○	E480340						
Battery-less absolute (Step motor 24 VDC)	JXCE1	○	○	○	E480340						
	JXC91	○	○	○	E480340						
	JXCP1	○	○	○	E480340						
	JXCD1	○	○	○	E480340						
	JXCL1	○	○	○	E480340						
	JXCM1	○	○	○	E480340						
High performance (Step motor 24 VDC)	JXC5H/6H	○	○	○	E480340						
	JXCEH	○	○	○	E480340						
	JXC9H	○	○	○	E480340						
Servo motor (24 VDC)	JXCPH	○	○	○	E480340						
	LECA6	○	○	○	E339743						
Step motor (Servo/24 VDC)	JXC73	○	x	○	—						
	JXC83	○	x	○	—						
	JXC93	○	x	○	—						
	JXC92	○	x	○	—						

*1 Only the “Without network card” option is UL compliant.

■ Actuators “○”: Compliant “x”: Not compliant

As of February 2022

Compatible motor	Series	CE UKCA		cULus		Compatible motor	Series	CE UKCA		cULus	
		Compliance	Certification No. (File No.)	Compliance	Certification No. (File No.)			Compliance	Certification No. (File No.)		
Step motor (Servo/24 VDC)	LEFS	○	x	○	—	Servo motor (24 VDC)	LEFS	○	x	○	—
	11-LEFS	○	x	○	—		11-LEFS	○	x	○	—
	25A-LEFS	○	x	○	—		25A-LEFS	○	x	○	—
	LEFB	○	x	○	—		LEFB	○	x	○	—
	LEL	○	x	○	—		LEY	○	x	○	—
	LEM	○	x	○	—		LEY-X5/X7	○	x	○	—
	LEY	○	x	○	—		LEYG	○	x	○	—
	25A-LEY	○	x	○	—		LES	○	x	○	—
	LEY-X5/X7	○	x	○	—		LESH	○	x	○	—
	LEYG	○	x	○	—		AC servo motor	LEFS	○	x	○
	LES	○	x	○	—	11-LEFS		○	x	○	—
	LESH	○	x	○	—	25A-LEFS		○	x	○	—
	LEPY	○	x	○	—	LEKFS		○	x	○	—
	LEPS	○	x	○	—	LEFB		○	x	○	—
	LER	○	x	○	—	LEJS		○	x	○	—
	LEHZ	○	x	○	—	11-LEJS		○	x	○	—
	LEHZJ	○	x	○	—	25A-LEJS		○	x	○	—
	LEHF	○	x	○	—	LEJB		○	x	○	—
	LEHS	○	x	○	—	LEY25/32/63		○	x	○	—
	Battery-less absolute (Step motor 24 VDC)	LEFS	○	x	○	—	LEY100	○	x	○	—
LEFB		○	x	○	—	LEYG	○	x	○	—	
LEKFS		○	x	○	—	LESYH	○	x	○	—	
LEY		○	x	○	—						
LEY-X8		○	x	○	—						
LEYG		○	x	○	—						
LES		○	x	○	—						
LESH		○	x	○	—						
LESYH		○	x	○	—						
LER		○	x	○	—						
High performance (Step motor 24 VDC)	LEHF	○	x	○	—						
	LEFS	○	x	○	—						
High performance battery-less absolute (Step motor 24 VDC)	LEFS	○	x	○	—						
	LEKFS	○	x	○	—						
	LEG	○	x	○	—						
	LESYH	○	x	○	—						

* Actuators ordered as single units are not UL compliant.

CE/UKCA/UL-compliance List

■ Actuators (When ordered with a controller) “○”: Compliant “x”: Not compliant “—”: Not applicable As of February 2022

Compatible motor	Series	JXC51/61			JXCE1			JXC91			JXCP1			JXCD1		
		CE UK CA	cULus		CE UK CA	cULus		CE UK CA	cULus		CE UK CA	cULus		CE UK CA	cULus	
			Compliance	Certification No. (File No.)		Compliance	Certification No. (File No.)		Compliance	Certification No. (File No.)		Compliance	Certification No. (File No.)		Compliance	Certification No. (File No.)
Step motor (Servo/24 VDC)	LEFS	○	○	E339743	○	○	E339743	○	○	E339743	○	○	E339743	○	○	E339743
	11-LEFS	○	○	E339743	○	○	E339743	○	○	E339743	○	○	E339743	○	○	E339743
	25A-LEFS	○	○	E339743	○	○	E339743	○	○	E339743	○	○	E339743	○	○	E339743
	LEFB	○	○	E339743	○	○	E339743	○	○	E339743	○	○	E339743	○	○	E339743
	LEL	○	○	E339743	○	○	E339743	○	○	E339743	○	○	E339743	○	○	E339743
	LEM	○	○	E339743	○	○	E339743	○	○	E339743	○	○	E339743	○	○	E339743
	LEY	○	○	E339743	○	○	E339743	○	○	E339743	○	○	E339743	○	○	E339743
	25A-LEY	○	○	E339743	○	○	E339743	○	○	E339743	○	○	E339743	○	○	E339743
	LEY-X5/X7	○	x	—	○	x	—	○	x	—	○	x	—	○	x	—
	LEYG	○	○	E339743	○	○	E339743	○	○	E339743	○	○	E339743	○	○	E339743
	LES	○	○	E339743	○	○	E339743	○	○	E339743	○	○	E339743	○	○	E339743
	LESH	○	○	E339743	○	○	E339743	○	○	E339743	○	○	E339743	○	○	E339743
	LEPY	○	○	E339743	○	○	E339743	○	○	E339743	○	○	E339743	○	○	E339743
	LEPS	○	○	E339743	○	○	E339743	○	○	E339743	○	○	E339743	○	○	E339743
	LER	○	○	E339743	○	○	E339743	○	○	E339743	○	○	E339743	○	○	E339743
	LEHZ	○	○	E339743	○	○	E339743	○	○	E339743	○	○	E339743	○	○	E339743
	LEHZJ	○	○	E339743	○	○	E339743	○	○	E339743	○	○	E339743	○	○	E339743
	LEHF	○	○	E339743	○	○	E339743	○	○	E339743	○	○	E339743	○	○	E339743
LEHS	○	○	E339743	○	○	E339743	○	○	E339743	○	○	E339743	○	○	E339743	
Compatible motor	Series	JXCL1			JXCM1			LECP1			LECP2			LECPA		
		CE UK CA	cULus		CE UK CA	cULus		CE UK CA	cULus		CE UK CA	cULus		CE UK CA	cULus	
			Compliance	Certification No. (File No.)		Compliance	Certification No. (File No.)		Compliance	Certification No. (File No.)		Compliance	Certification No. (File No.)		Compliance	Certification No. (File No.)
Step motor (Servo/24 VDC)	LEFS	○	○	E339743	○	○	E339743	○	○	E339743	—	—	—	○	○	E339743
	11-LEFS	○	○	E339743	○	○	E339743	○	○	E339743	—	—	—	○	○	E339743
	25A-LEFS	○	○	E339743	○	○	E339743	○	○	E339743	—	—	—	○	○	E339743
	LEFB	○	○	E339743	○	○	E339743	○	○	E339743	—	—	—	○	○	E339743
	LEL	○	○	E339743	○	○	E339743	○	○	E339743	—	—	—	○	○	E339743
	LEM	○	○	E339743	○	○	E339743	○	○	E339743	○	○	E339743	○	○	E339743
	LEY	○	○	E339743	○	○	E339743	○	○	E339743	—	—	—	○	○	E339743
	25A-LEY	○	○	E339743	○	○	E339743	○	○	E339743	—	—	—	○	○	E339743
	LEY-X5/X7	○	x	—	○	x	—	○	x	—	—	—	—	○	x	—
	LEYG	○	○	E339743	○	○	E339743	○	○	E339743	—	—	—	○	○	E339743
	LES	○	○	E339743	○	○	E339743	○	○	E339743	—	—	—	○	○	E339743
	LESH	○	○	E339743	○	○	E339743	○	○	E339743	—	—	—	○	○	E339743
	LEPY	○	○	E339743	○	○	E339743	○	○	E339743	—	—	—	○	○	E339743
	LEPS	○	○	E339743	○	○	E339743	○	○	E339743	—	—	—	○	○	E339743
	LER	○	○	E339743	○	○	E339743	○	○	E339743	—	—	—	○	○	E339743
	LEHZ	○	○	E339743	○	○	E339743	○	○	E339743	—	—	—	○	○	E339743
	LEHZJ	○	○	E339743	○	○	E339743	○	○	E339743	—	—	—	○	○	E339743
	LEHF	○	○	E339743	○	○	E339743	○	○	E339743	—	—	—	○	○	E339743
LEHS	○	○	E339743	○	○	E339743	○	○	E339743	—	—	—	○	○	E339743	

CE/UKCA/UL-compliance List

■ Actuators (When ordered with a controller) “○”: Compliant “x”: Not compliant “—”: Not applicable As of February 2022

Compatible motor	Series	JXC51/61			JXCE1			JXC91			JXCP1			JXCD1		
		CE UK CA	cULus		CE UK CA	cULus		CE UK CA	cULus		CE UK CA	cULus		CE UK CA	cULus	
			Compliance	Certification No. (File No.)		Compliance	Certification No. (File No.)		Compliance	Certification No. (File No.)		Compliance	Certification No. (File No.)		Compliance	Certification No. (File No.)
Battery-less absolute (Step motor 24 VDC)	LEFS	○	x	—	○	x	—	○	x	—	○	x	—	○	x	—
	LEFB	○	x	—	○	x	—	○	x	—	○	x	—	○	x	—
	LEKFS	○	x	—	○	x	—	○	x	—	○	x	—	○	x	—
	LEY	○	x	—	○	x	—	○	x	—	○	x	—	○	x	—
	LEY-X8	○	x	—	○	x	—	○	x	—	○	x	—	○	x	—
	LEYG	○	x	—	○	x	—	○	x	—	○	x	—	○	x	—
	LES	○	x	—	○	x	—	○	x	—	○	x	—	○	x	—
	LESH	○	x	—	○	x	—	○	x	—	○	x	—	○	x	—
	LESYH	○	x	—	○	x	—	○	x	—	○	x	—	○	x	—
	LER	○	x	—	○	x	—	○	x	—	○	x	—	○	x	—
LEHF	○	x	—	○	x	—	○	x	—	○	x	—	○	x	—	

Compatible motor	Series	JXCL1			JXCM1		
		CE UK CA	cULus		CE UK CA	cULus	
			Compliance	Certification No. (File No.)		Compliance	Certification No. (File No.)
Battery-less absolute (Step motor 24 VDC)	LEFS	○	x	—	○	x	—
	LEFB	○	x	—	○	x	—
	LEKFS	○	x	—	○	x	—
	LEY	○	x	—	○	x	—
	LEY-X8	○	x	—	○	x	—
	LEYG	○	x	—	○	x	—
	LES	○	x	—	○	x	—
	LESH	○	x	—	○	x	—
	LESYH	○	x	—	○	x	—
	LER	○	x	—	○	x	—
LEHF	○	x	—	○	x	—	

■ Actuators (When ordered with a controller) “○”: Compliant “x”: Not compliant “—”: Not applicable As of February 2022

Compatible motor	Series	JXC5H/6H			JXCEH			JXC9H			JXCPH		
		CE UK CA	cRU ^{us}		CE UK CA	cRU ^{us}		CE UK CA	cRU ^{us}		CE UK CA	cRU ^{us}	
			Compliance	Certification No. (File No.)		Compliance	Certification No. (File No.)		Compliance	Certification No. (File No.)		Compliance	Certification No. (File No.)
High performance (Step motor 24 VDC)	LEF	○	○	E339743	○	○	E339743	○	○	E339743	○	○	E339743
High performance battery-less absolute (Step motor 24 VDC)	LEFS	○	x	—	○	x	—	○	x	—	○	x	—
	LEKFS	○	x	—	○	x	—	○	x	—	○	x	—
	LEG	○	x	—	○	x	—	○	x	—	○	x	—
	LESYH	○	x	—	○	x	—	○	x	—	○	x	—

Compatible motor	Series	LECA6		
		CE UK CA	cRU ^{us}	
			Compliance	Certification No. (File No.)
Servo motor (24 VDC)	LEFS	○	○	E339743
	11-LEFS	○	○	E339743
	25A-LEFS	○	○	E339743
	LEFB	○	○	E339743
	LEY	○	○	E339743
	LEY-X5/X7	○	x	—
	LEYG	○	○	E339743
	LES	○	○	E339743
	LESH	○	○	E339743

Compatible motor	Series	LECSA*1			LECSB-T*1			LECS-C-T*1			LECSN-T*1			LECSS-T*1		
		CE UK CA	cRU ^{us}		CE UK CA	cRU ^{us}		CE UK CA	cRU ^{us}		CE UK CA	cRU ^{us}		CE UK CA	cRU ^{us}	
			Compliance	Certification No. (File No.)		Compliance	Certification No. (File No.)		Compliance	Certification No. (File No.)		Compliance	Certification No. (File No.)		Compliance	Certification No. (File No.)
AC servo motor	LEFS	○	○	E339743	○	x	—	○	x	—	○	x	—	○	○	E339743
	11-LEFS	○	○	E339743	○	x	—	○	x	—	○	x	—	○	○	E339743
	25A-LEFS	○	○	E339743	○	x	—	○	x	—	○	x	—	○	○	E339743
	LEKFS	○	x	—	○	x	—	○	x	—	○	x	—	○	x	—
	LEFB	○	○	E339743	○	x	—	○	x	—	○	x	—	○	○	E339743
	LEJS	○	○	E339743	○	x	—	○	x	—	○	x	—	○	○	E339743
	11-LEJS	○	○	E339743	○	x	—	○	x	—	○	x	—	○	○	E339743
	25A-LEJS	○	○	E339743	○	x	—	○	x	—	○	x	—	○	○	E339743
	LEJB	○	○	E339743	○	x	—	○	x	—	○	x	—	○	○	E339743
	LEY25/32/63	○	○	E339743	○	x	—	○	x	—	○	x	—	○	○	E339743
	LEY100	—	—	—	○	x	—	○	x	—	○	x	—	○	x	—
	LEYG	○	○	E339743	○	x	—	○	x	—	○	x	—	○	○	E339743
	LESYH	○	x	—	○	x	—	○	x	—	○	x	—	○	x	—

Compatible motor	Series	LECYM-V			LECYU-V		
		CE UK CA	cRU ^{us}		CE UK CA	cRU ^{us}	
			Compliance	Certification No. (File No.)		Compliance	Certification No. (File No.)
AC servo motor	LEFS	○	x	—	○	x	—
	11-LEFS	○	x	—	○	x	—
	25A-LEFS	○	x	—	○	x	—
	LEKFS	○	x	—	○	x	—
	LEFB	○	x	—	○	x	—
	LEJS	○	x	—	○	x	—
	11-LEJS	○	x	—	○	x	—
	25A-LEJS	○	x	—	○	x	—
	LEJB	○	x	—	○	x	—
	LEY25/32/63	○	x	—	○	x	—
	LEY100	○	x	—	○	x	—
	LEYG	○	x	—	○	x	—
LESYH	○	x	—	○	x	—	

*1 There is a “UL Listed” mark on the AC servo motor driver body.

Safety Instructions

These safety instructions are intended to prevent hazardous situations and/or equipment damage. These instructions indicate the level of potential hazard with the labels of “**Caution**,” “**Warning**” or “**Danger**.” They are all important notes for safety and must be followed in addition to International Standards (ISO/IEC)*1), and other safety regulations.

 **Caution:** **Caution** indicates a hazard with a low level of risk which, if not avoided, could result in minor or moderate injury.

 **Warning:** **Warning** indicates a hazard with a medium level of risk which, if not avoided, could result in death or serious injury.

 **Danger:** **Danger** indicates a hazard with a high level of risk which, if not avoided, will result in death or serious injury.

*1) ISO 4414: Pneumatic fluid power – General rules relating to systems.
ISO 4413: Hydraulic fluid power – General rules relating to systems.
IEC 60204-1: Safety of machinery – Electrical equipment of machines.
(Part 1: General requirements)
ISO 10218-1: Manipulating industrial robots – Safety.
etc.

Warning

1. The compatibility of the product is the responsibility of the person who designs the equipment or decides its specifications.

Since the product specified here is used under various operating conditions, its compatibility with specific equipment must be decided by the person who designs the equipment or decides its specifications based on necessary analysis and test results. The expected performance and safety assurance of the equipment will be the responsibility of the person who has determined its compatibility with the product. This person should also continuously review all specifications of the product referring to its latest catalog information, with a view to giving due consideration to any possibility of equipment failure when configuring the equipment.

2. Only personnel with appropriate training should operate machinery and equipment.

The product specified here may become unsafe if handled incorrectly. The assembly, operation and maintenance of machines or equipment including our products must be performed by an operator who is appropriately trained and experienced.

3. Do not service or attempt to remove product and machinery/equipment until safety is confirmed.

1. The inspection and maintenance of machinery/equipment should only be performed after measures to prevent falling or runaway of the driven objects have been confirmed.
2. When the product is to be removed, confirm that the safety measures as mentioned above are implemented and the power from any appropriate source is cut, and read and understand the specific product precautions of all relevant products carefully.
3. Before machinery/equipment is restarted, take measures to prevent unexpected operation and malfunction.

4. Contact SMC beforehand and take special consideration of safety measures if the product is to be used in any of the following conditions.

1. Conditions and environments outside of the given specifications, or use outdoors or in a place exposed to direct sunlight.
2. Installation on equipment in conjunction with atomic energy, railways, air navigation, space, shipping, vehicles, military, medical treatment, combustion and recreation, or equipment in contact with food and beverages, emergency stop circuits, clutch and brake circuits in press applications, safety equipment or other applications unsuitable for the standard specifications described in the product catalog.
3. An application which could have negative effects on people, property, or animals requiring special safety analysis.
4. Use in an interlock circuit, which requires the provision of double interlock for possible failure by using a mechanical protective function, and periodical checks to confirm proper operation.

Caution

1. The product is provided for use in manufacturing industries.

The product herein described is basically provided for peaceful use in manufacturing industries.
If considering using the product in other industries, consult SMC beforehand and exchange specifications or a contract if necessary.
If anything is unclear, contact your nearest sales branch.

Limited warranty and Disclaimer/ Compliance Requirements

The product used is subject to the following “Limited warranty and Disclaimer” and “Compliance Requirements”.

Read and accept them before using the product.

Limited warranty and Disclaimer

1. The warranty period of the product is 1 year in service or 1.5 years after the product is delivered, whichever is first.*2)
Also, the product may have specified durability, running distance or replacement parts. Please consult your nearest sales branch.
2. For any failure or damage reported within the warranty period which is clearly our responsibility, a replacement product or necessary parts will be provided.
This limited warranty applies only to our product independently, and not to any other damage incurred due to the failure of the product.
3. Prior to using SMC products, please read and understand the warranty terms and disclaimers noted in the specified catalog for the particular products.

*2) Vacuum pads are excluded from this 1 year warranty.

A vacuum pad is a consumable part, so it is warranted for a year after it is delivered.
Also, even within the warranty period, the wear of a product due to the use of the vacuum pad or failure due to the deterioration of rubber material are not covered by the limited warranty.

Compliance Requirements

1. The use of SMC products with production equipment for the manufacture of weapons of mass destruction (WMD) or any other weapon is strictly prohibited.
2. The exports of SMC products or technology from one country to another are governed by the relevant security laws and regulations of the countries involved in the transaction. Prior to the shipment of a SMC product to another country, assure that all local rules governing that export are known and followed.

Caution

SMC products are not intended for use as instruments for legal metrology.

Measurement instruments that SMC manufactures or sells have not been qualified by type approval tests relevant to the metrology (measurement) laws of each country. Therefore, SMC products cannot be used for business or certification ordained by the metrology (measurement) laws of each country.

Safety Instructions

Be sure to read the “Handling Precautions for SMC Products” (M-E03-3) and “Operation Manual” before use.

SMC Corporation

Akihabara UDX 15F,
4-14-1, Sotokanda, Chiyoda-ku, Tokyo 101-0021, JAPAN
Phone: 03-5207-8249 Fax: 03-5298-5362
<https://www.smcworld.com>
© 2022 SMC Corporation All Rights Reserved

Specifications are subject to change without prior notice and any obligation on the part of the manufacturer.

D-G