

High Precision Type

Electric Slide Table



New Size 25 has been added.

Positioning repeatability

±0.01 mm

Due to the adoption of a ball screw drive

Lost motion

0.1 mm or less

Increased vertical work load

5 times or more	New LESYH	16 12 kg	25 20 kg
	Existing model LESH	2 kg	4 kg

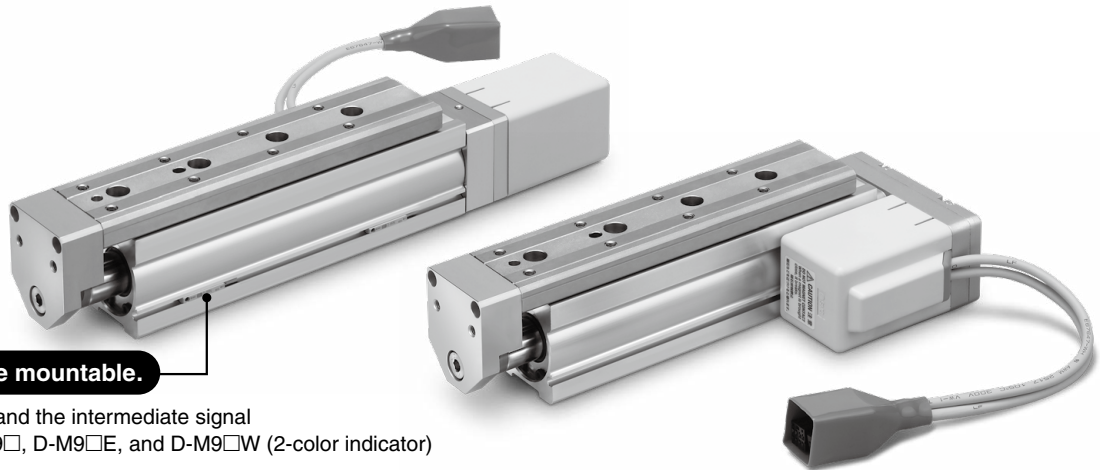

Auto switches are mountable.

For checking the limit and the intermediate signal
Applicable to the D-M9□, D-M9□E, and D-M9□W (2-color indicator)

Battery-less absolute encoder compatible

Step motor controller JXC Series

Battery-less absolute type (Step motor 24 VDC)

EtherCAT [®] direct input type	EtherNet/IP [™] direct input type	PROFINET [®] direct input type	DeviceNet [™] direct input type	IO-Link [™] direct input type	CC-Link direct input type	Step data input type
JXCE1	JXC91	JXCP1	JXCD1	JXCL1	New JXCM1	New JXC51 JXC61

Trademark

EtherNet/IP[™] is a trademark of ODVA.

DeviceNet[™] is a trademark of ODVA.

EtherCAT[®] is registered trademark and patented technology, licensed by Beckhoff Automation GmbH, Germany.

LESYH-X171



High Precision Type/Electric Slide Table LESYH-X171 Model Selection 1



Selection Procedure



Selection Example

Step 1 Check the work load-speed. <Speed-Work load graph> (page 2)
Select a model based on the workpiece mass and speed while referencing the speed-work load graph.
Selection example) The LESYH16□A-50-X171 can be temporarily selected as a possible candidate based on the graph shown on the right side.

Step 2 Check the cycle time.
It is possible to obtain an approximate cycle time by using method 1, but if more detailed cycle time is required, use method 2.
* Although it is possible to make a suitable selection by using method 1, this calculation is based on a maximum load condition. Therefore, if a more detailed selection for each load is required, use method 2.

Method 1: Check the cycle time graph. (Refer to the Web Catalog.)

Method 2: Calculation <Speed-Work load graph> (page 2)
Calculate the cycle time using the following calculation method.

Cycle time:
T can be found from the following equation.

$$T = T1 + T2 + T3 + T4 \text{ [s]}$$

- T1: Acceleration time and T3: Deceleration time can be found by the following equation.

$$T1 = V/a1 \text{ [s]} \quad T3 = V/a2 \text{ [s]}$$

- T2: Constant speed time can be found from the following equation.

$$T2 = \frac{L - 0.5 \cdot V \cdot (T1 + T3)}{V} \text{ [s]}$$

- T4: Settling time varies depending on the conditions such as motor types, load, and in position of the step data. Therefore, calculate the settling time while referencing the following value.

$$T4 = 0.15 \text{ [s]}$$

Calculation example
T1 to T4 can be calculated as follows.

$$T1 = V/a1 = 200/3000 = 0.07 \text{ [s]}$$

$$T3 = V/a2 = 200/3000 = 0.07 \text{ [s]}$$

$$T2 = \frac{L - 0.5 \cdot V \cdot (T1 + T3)}{V} = \frac{50 - 0.5 \cdot 200 \cdot (0.07 + 0.07)}{200} = 0.21 \text{ [s]}$$

$$T4 = 0.15 \text{ [s]}$$

The cycle time can be found as follows.

$$T = T1 + T2 + T3 + T4 = 0.07 + 0.21 + 0.07 + 0.15 = 0.50 \text{ [s]}$$

Operating conditions

- Workpiece mass: 1 [kg]
- Workpiece mounting condition:
- Speed: 200 [mm/s]
- Mounting orientation: Vertical
- Stroke: 50 [mm]
- Acceleration/Deceleration: 3000 [mm/s²]
- Cycle time: 0.5 s

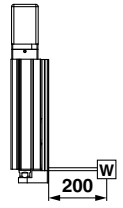

LESYH16□□-X171/Step Motor Vertical

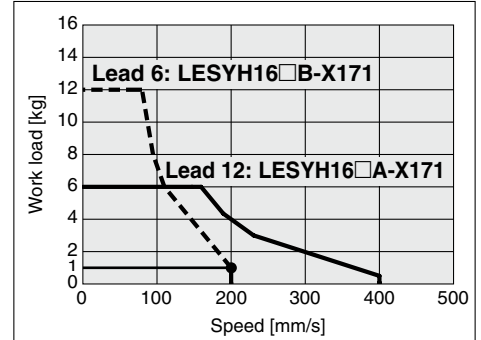

<Speed-Work load graph>

Step 3 Check the allowable moment.
<Static allowable moment> (page 2)
<Dynamic allowable moment> (pages 3, 4)
Confirm the moment that applies to the actuator is within the allowable range for both static and dynamic conditions.

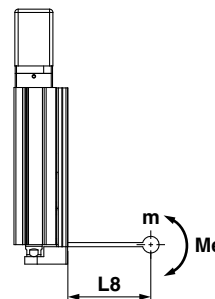

LESYH16-X171/Pitching

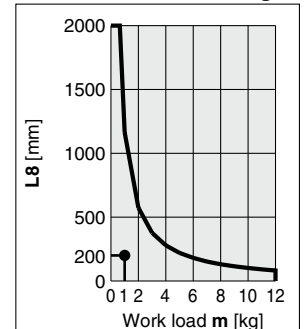

<Dynamic allowable moment>

Based on the above calculation result, the LESYH16□A-50-X171 should be selected.

Speed-Work Load Graph (Guide)

LESYH16□-X171

Horizontal

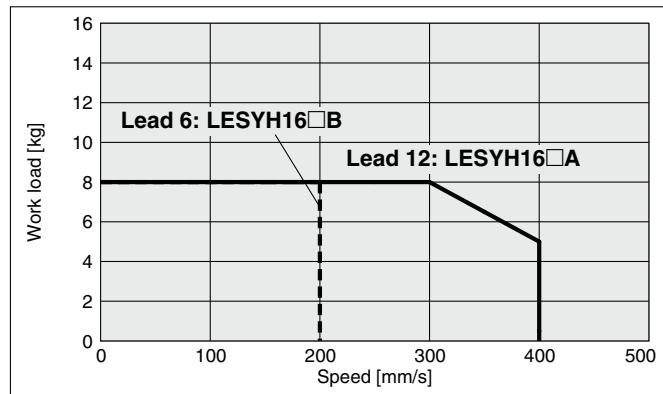

Vertical

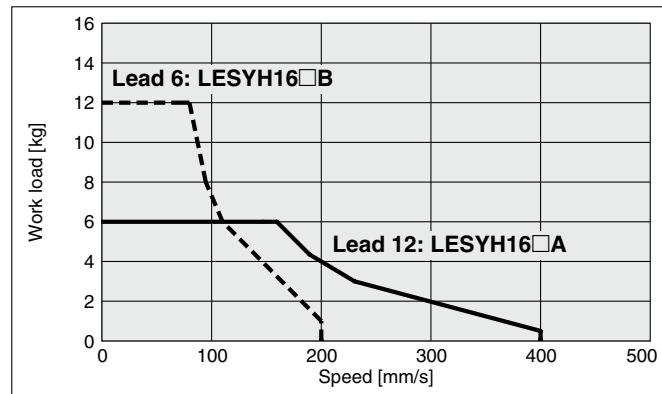

LESYH25□-X171

Horizontal

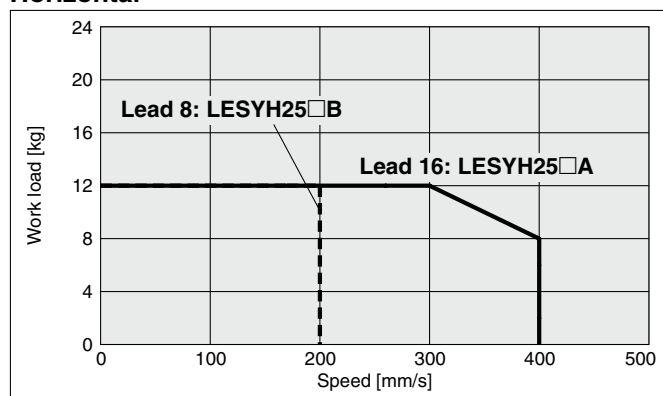

Vertical

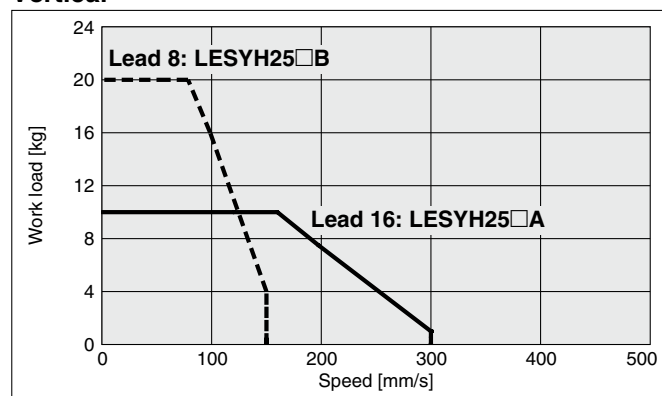

Static Allowable Moment

Model	LESYH16-X171		LESYH25-X171		
	50	100	50	100	150
Pitching [N·m]	26	43	77	112	155
Yawing [N·m]					
Rolling [N·m]	48		146	177	152

LESYH-X171

Battery-less Absolute (Step Motor 24 VDC)

* This graph shows the amount of allowable overhang (guide unit) when the center of gravity of the workpiece overhangs in one direction. When selecting the overhang, refer to "Calculation of Guide Load Factor" or the Electric Actuator Model Selection Software for confirmation, <https://www.smcworld.com>

Dynamic Allowable Moment

Acceleration/Deceleration — 5000 mm/s²

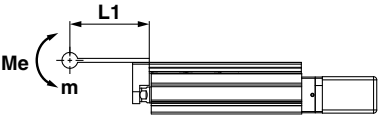
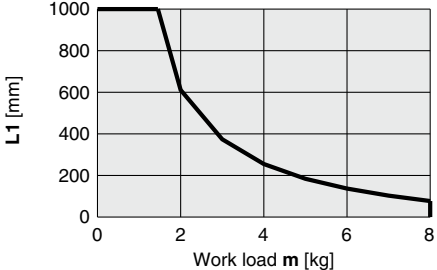
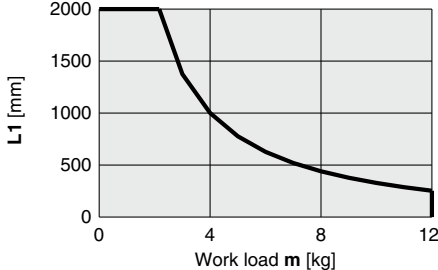
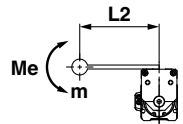
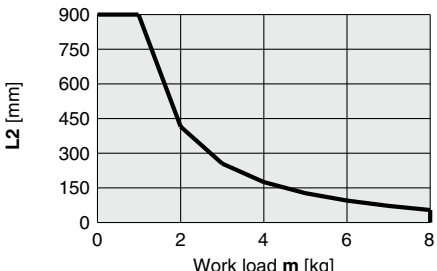
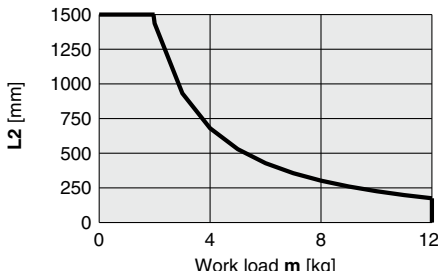
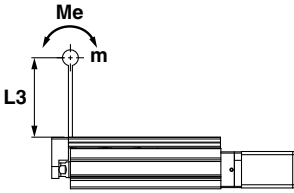
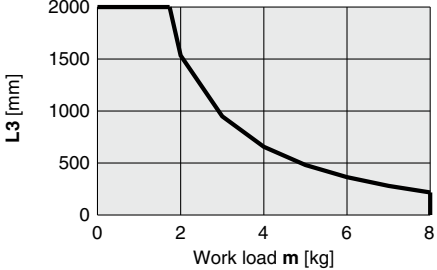
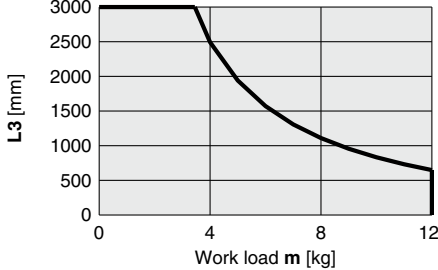
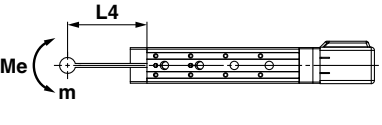
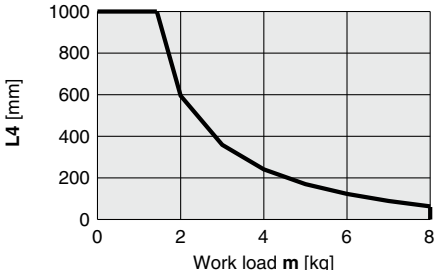
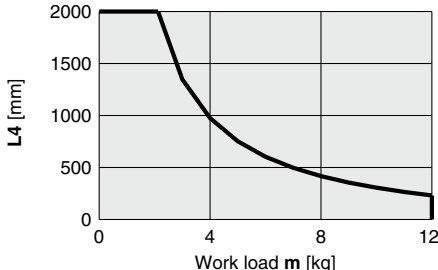
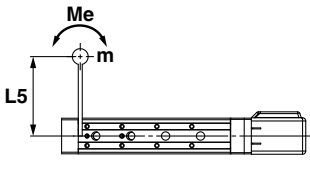
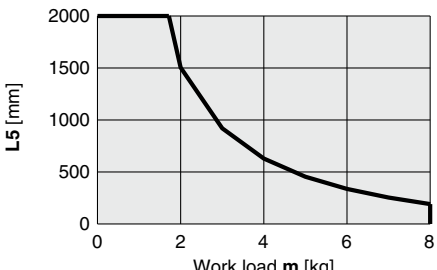
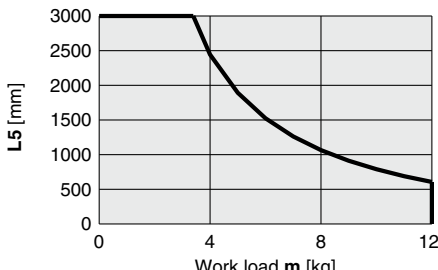
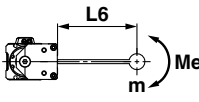
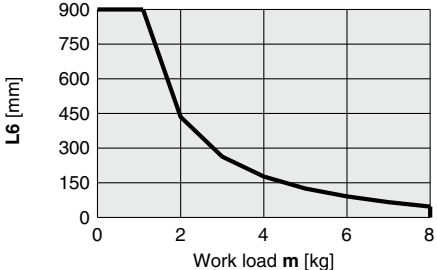
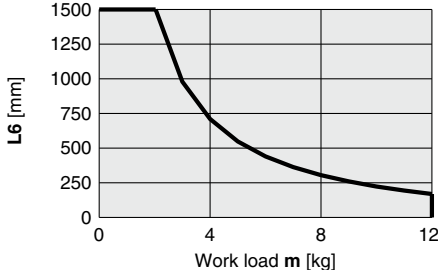
Orientation	Load overhanging direction m: Work load [kg] Me: Dynamic allowable moment [N·m] L: Overhang to the work load center of gravity [mm]	Model	
		LESYH16-X171	LESYH25-X171
Horizontal/Bottom	 <p>X</p> <p>L1 [mm]</p>		
	 <p>Y</p> <p>L2 [mm]</p>		
	 <p>Z</p> <p>L3 [mm]</p>		
Horizontal (Wall)	 <p>X</p> <p>L4 [mm]</p>		
	 <p>Y</p> <p>L5 [mm]</p>		
	 <p>Z</p> <p>L6 [mm]</p>		

* This graph shows the amount of allowable overhang (guide unit) when the center of gravity of the workpiece overhangs in one direction. When selecting the overhang, refer to "Calculation of Guide Load Factor" or the Electric Actuator Model Selection Software for confirmation, <https://www.smcworld.com>

Dynamic Allowable Moment

Acceleration/Deceleration — 5000 mm/s²

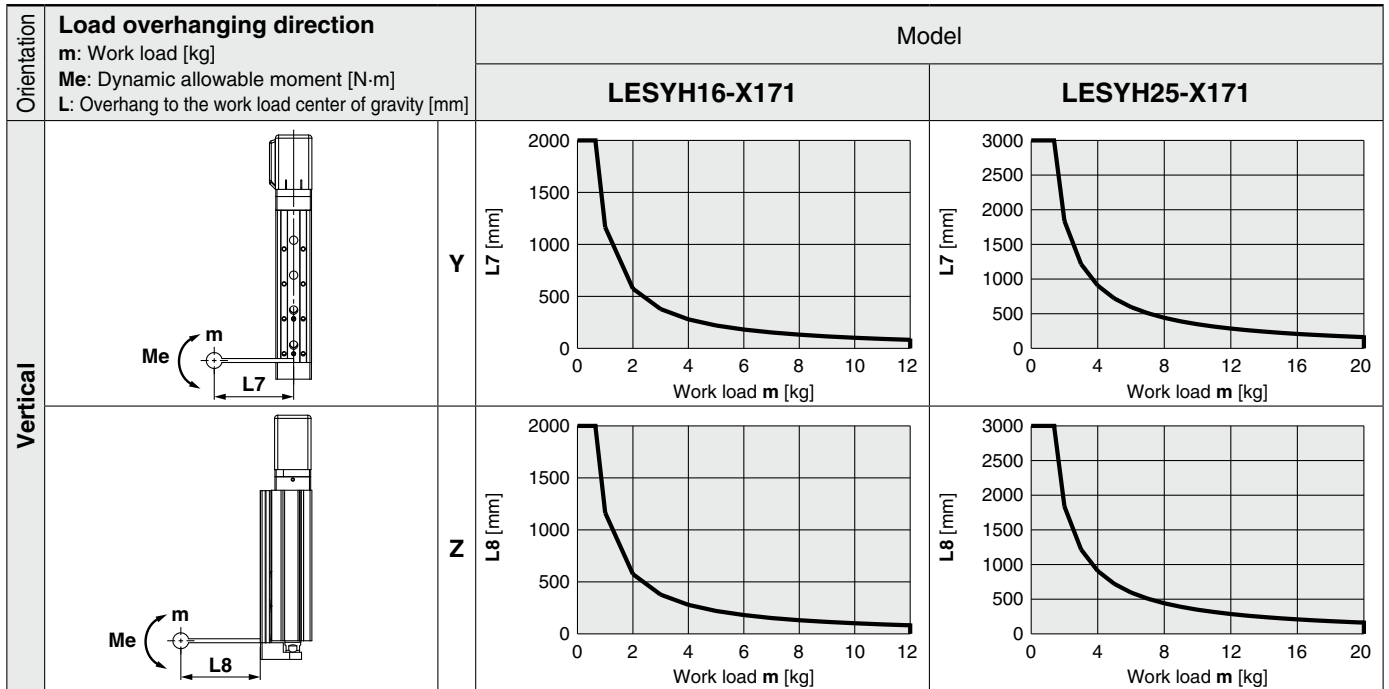

Calculation of Guide Load Factor

- Decide operating conditions.

Model: LESYH

Size: 16

Mounting orientation: Horizontal/Bottom/Wall/Vertical

Acceleration [mm/s²]: a

Work load [kg]: m

Work load center position [mm]: Xc/Yc/Zc

- Select the target graph with reference to the model, size, and mounting orientation.

- Based on the acceleration and work load, obtain the overhang [mm]: Lx/Ly/Lz from the graph.

- Calculate the load factor for each direction.

$$\alpha_x = X_c/L_x, \alpha_y = Y_c/L_y, \alpha_z = Z_c/L_z$$

- Confirm the total of α_x , α_y , and α_z is 1 or less.

$$\alpha_x + \alpha_y + \alpha_z \leq 1$$

When 1 is exceeded, please consider a reduction of acceleration and work load, or a change of the work load center position and series.

Mounting orientation

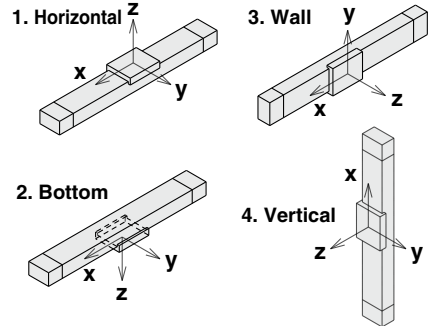

Example

- Operating conditions

Model: LESYH

Size: 16

Mounting orientation: Horizontal

Acceleration [mm/s²]: 5000

Work load [kg]: 4.0

Work load center position [mm]: Xc = 80, Yc = 50, Zc = 60

- Select three graphs from the top on page 3.

- Lx = 250 mm, Ly = 160 mm, Lz = 700 mm

- The load factor for each direction can be obtained as follows.

$$\alpha_x = 80/250 = 0.32$$

$$\alpha_y = 50/160 = 0.32$$

$$\alpha_z = 60/700 = 0.09$$

- $\alpha_x + \alpha_y + \alpha_z = 0.73 \leq 1$

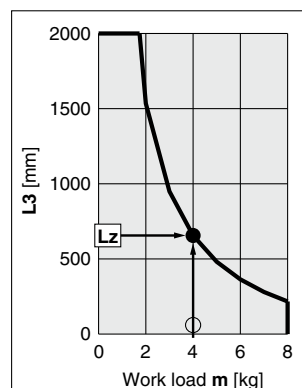
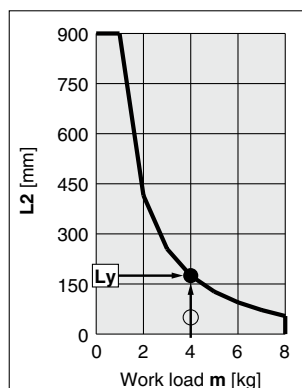
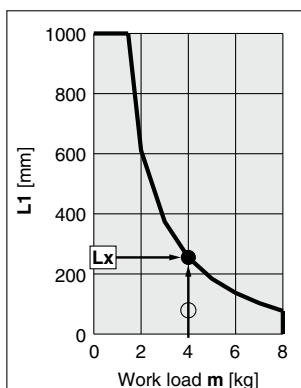

High Precision Type/Electric Slide Table LESYH-X171 Model Selection 2



Selection Procedure

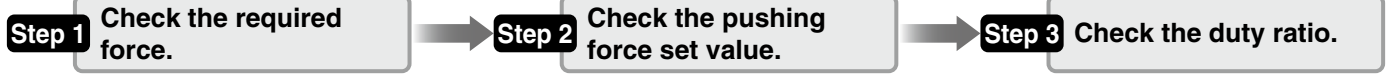

Selection Example

Operating conditions

- Pushing force: 150 N
- Workpiece mass: 1 kg
- Speed: 100 mm/s
- Stroke: 100 mm
- Mounting position: Vertical upward
- Pushing time + Operation (A): 1.5 s
- Full cycle time (B): 10 s

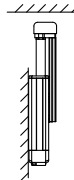

Step 1 Check the required force.

Calculate the approximate required force for a pushing operation.

- Selection example) • Pushing force: 150 [N]
• Workpiece mass: 1 [kg]

The approximate required force can be found to be $150 + 10 = 160$ [N].

Select a model based on the approximate required force while referencing the specifications (page 9).

Selection example based on the specifications)

- Approximate required force: 160 [N]
- Speed: 100 [mm/s]

The LESYH16□A-X171 can be temporarily selected as a possible candidate.

Then, calculate the required force for a pushing operation. If the mounting position is vertical upward, add the actuator table weight.

Selection example based on the table weight)

- LESYH16□A-X171 table weight: 0.7 [kg]

The required force can be found to be $160 + 7 = 167$ [N].

Step 2 Check the pushing force set value.

<Pushing force set value>

Select a model based on the pushing force in the specifications, and confirm the pushing force set value.

Selection example)

- Required force: 167 [N]
- The LESYH16□A-X171 can be temporarily selected as a possible candidate.
The pushing force set value is 64 [%].

Step 3 Check the duty ratio.

Confirm the allowable duty ratio based on the pushing force set value while referencing the allowable duty ratio.

Selection example based on the allowable duty ratio)

- Pushing force set value: 64 [%]

The allowable duty ratio can be found to be 20 [%].

Calculate the duty ratio for the operating conditions, and confirm it does not exceed the allowable duty ratio.

- Selection example) • Pushing time + Operation (A): 1.5 s
• Full cycle time (B): 10 s

The duty ratio can be found to be $1.5/10 \times 100 = 15$ [%], and this is within the allowable range.

Table Weight

Unit [kg]

Model	Stroke [mm]		
	50	100	150
LESYH16-X171	0.4	0.7	—
LESYH25-X171	0.9	1.3	1.7

* If the mounting position is vertical upward, add the table weight.

Allowable Duty Ratio

Step Motor (Servo 24 VDC)

Pushing force set value [%]	Duty ratio [%]	Continuous pushing time [min]
35	—	—
50 or less	30 or less	5 or less
70 or less	20 or less	3 or less

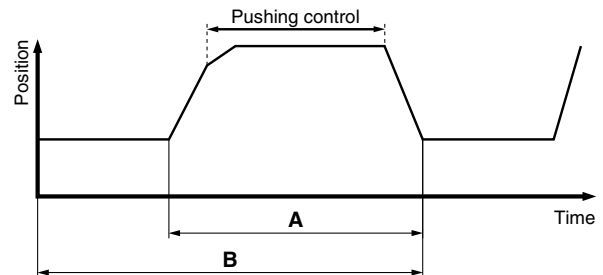

Based on the above calculation result, the LESYH16□A-100-X171 should be selected.

For the allowable moment, the selection procedure is the same as that for the positioning control.

Table Accuracy

* These values are initial guideline values.

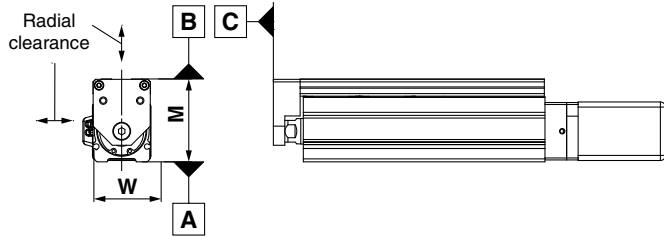

Model	LESYH16-X171	LESYH25-X171
B side parallelism to A side [mm]	Refer to Table 1.	
B side traveling parallelism to A side [mm]	Refer to Graph 1.	
C side perpendicularity to A side [mm]	0.05	
M dimension tolerance [mm]	±0.3	
W dimension tolerance [mm]	±0.2	
Radial clearance [μm]	-10 to 0	-14 to 0

Table 1 B side parallelism to A side

Model	Stroke [mm]		
	50	100	150
LESYH16-X171	0.05	0.08	—
LESYH25-X171	0.06	0.08	0.125

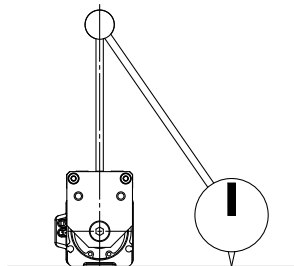

Traveling parallelism:
The amount of deflection on a dial gauge when the table travels a full stroke with the body secured on a reference base surface

Graph 1 B side traveling parallelism to A side

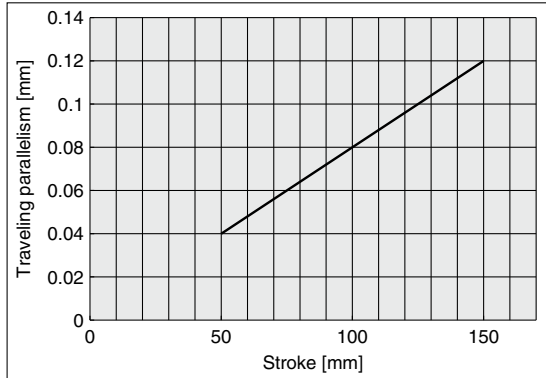
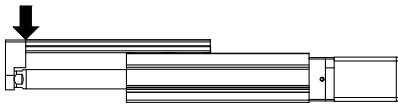

Table Deflection (Reference Value)

* These values are initial guideline values.

Table displacement due to pitch moment load
Table displacement when loads are applied to the section marked with the arrow with the slide table stuck out.



LESYH16-X171

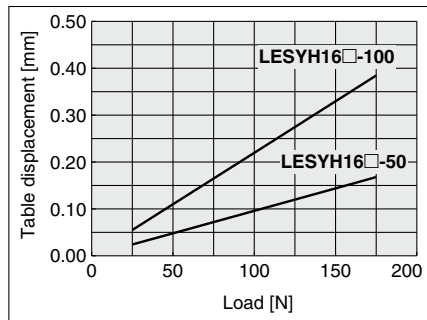
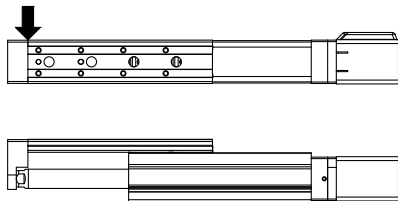

Table displacement due to yaw moment load
Table displacement when loads are applied to the section marked with the arrow with the slide table stuck out.



LESYH16-X171

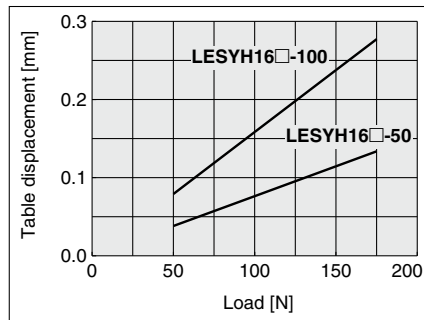
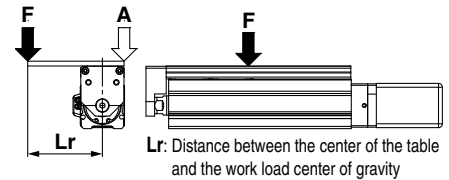
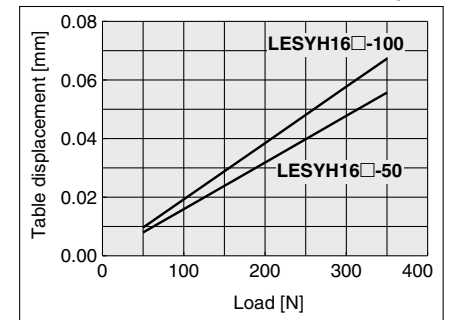

Table displacement due to roll moment load
Table displacement of section A when loads are applied to the section F with the slide table retracted.



LESYH16-X171

Lr = 120 mm



LESYH25-X171

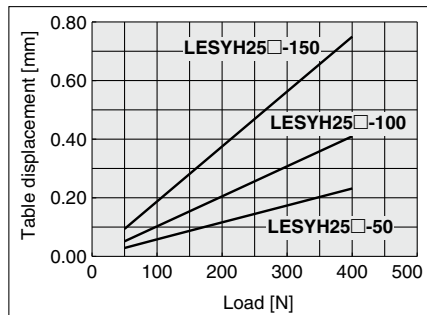

LESYH25-X171

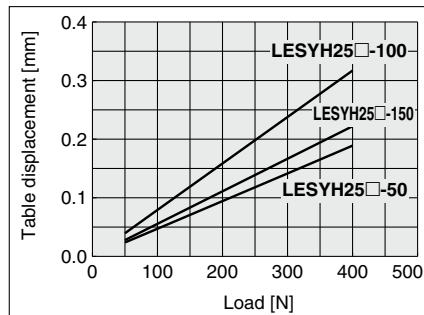

LESYH25-X171

Lr = 200 mm

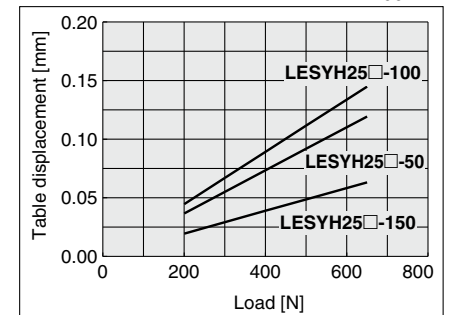

Battery-less Absolute (Step Motor 24 VDC)

Battery-less Absolute Encoder: High Precision Type/Electric Slide Table *LESYH-X171*



How to Order

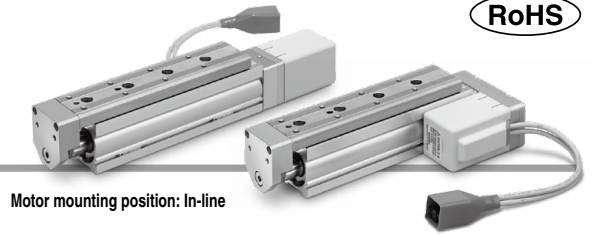

Motor mounting position: In-line

Motor mounting position: Left side parallel

LESYH 16 D E A - 50 C - R1 CD17T - X171

1
 2
 3
 4
 5
 6
 7
 8

For details on controllers, refer to the next page.

1 Size

16
25

2 Motor mounting position

D	In-line
R	Right side parallel
L	Left side parallel

3 Motor type

E	Battery-less absolute (Step motor 24 VDC)
----------	---

4 Lead [mm]

	Size	
	16	25
A	12	16
B	6	8

5 Stroke [mm]

	Size	
	16	25
50	●	●
100	●	●
150		●

6 Motor option

C	With cover
W	With lock/cover

7 Actuator cable type/length

Robotic cable				[m]
Nil	Without cable	R8		8*1
R1	1.5	RA		10*1
R3	3	RB		15*1
R5	5	RC		20*1

8 Controller

Nil	Without controller
C□1□□	With controller



Interface (Communication protocol/ Input/Output)

E	EtherCAT®
9	EtherNet/IP™
P	PROFINET
D	DeviceNet™
L	IO-Link
M	CC-Link Ver. 1.10
5	Parallel input (NPN)
6	Parallel input (PNP)

Mounting

7	Screw mounting
8*2	DIN rail

For single axis

Communication plug connector I/O cable*3

Symbol	Type	Applicable interface
Nil	Without accessory	—
S	Straight type communication plug connector	DeviceNet™
T	T-branch type communication plug connector	CC-Link Ver. 1.10
1	I/O cable (1.5 m)	Parallel input (NPN) Parallel input (PNP)
3	I/O cable (3 m)	
5	I/O cable (5 m)	

*1 Produced upon receipt of order

*2 The DIN rail is not included. Order it separately.

*3 Select "Nil" for anything other than DeviceNet™, CC-Link, or parallel input.

Select "Nil," "S," or "T" for DeviceNet™ or CC-Link.
Select "Nil," "1," "3," or "5" for parallel input.

Caution

[CE-compliant products]

EMC compliance was tested by combining the electric actuator LES series and the controller JXC series.

The EMC depends on the configuration of the customer's control panel and the relationship with other electrical equipment and wiring. Therefore, compliance with the EMC directive cannot be certified for SMC components incorporated into the customer's equipment under actual operating conditions. As a result, it is necessary for the customer to verify compliance with the EMC directive for the machinery and equipment as a whole.

[Precautions relating to differences in controller versions]

When the JXC series is to be used in combination with the battery-less absolute encoder, use a controller that is version V3.4 or S3.4 or higher. For details, refer to the **Web Catalog**.

The actuator and controller are sold as a package.

Confirm that the combination of the controller and actuator is correct.

<Check the following before use.>

*1 Check the actuator label for the model number. This number should match that of the controller.

LESYH16REA-50-X171

*1



* Refer to the Operation Manual for using the products. Please download it via our website, <https://www.smcworld.com>

Type	EtherCAT® direct input type	EtherNet/IP™ direct input type	PROFINET direct input type	DeviceNet™ direct input type	IO-Link direct input type	CC-Link direct input type	Step data input type
Series	JXCE1	JXC91	JXCP1	JXCD1	JXCL1	JXCM1	JXC51 JXC61
Features	EtherCAT® direct input	EtherNet/IP™ direct input	PROFINET direct input	DeviceNet™ direct input	IO-Link direct input	CC-Link direct input	Parallel I/O
Compatible motor	Battery-less absolute (Step motor 24 VDC)						
Max. number of step data	64 points						
Power supply voltage	24 VDC						
Reference page	16						22

LESYH-X171

Battery-less Absolute (Step Motor 24 VDC)

Specifications

Step Motor (Servo/24 VDC)

Model		LESYH16□EB-X171	LESYH16□EA-X171	LESYH25□EB-X171	LESYH25□EA-X171	
Actuator specifications	Stroke [mm]	50, 100		50, 100, 150		
	Max. work load [kg] ^{*1 *3}	Horizontal	8		12	
		Vertical	12	6	20	10
	Pushing force 35% to 70% [N] ^{*2 *3}	174 to 348	91 to 182	210 to 420	109 to 218	
	Speed [mm/s] ^{*1 *3}	10 to 200	20 to 400	10 to 200	20 to 400	
	Pushing speed [mm/s]	10 to 30	20 to 30	10 to 30	20 to 30	
	Max. acceleration/deceleration [mm/s ²]	5000				
	Positioning repeatability [mm]	±0.01				
	Lost motion [mm] ^{*4}	0.1 or less				
	Screw lead [mm]	6	12	8	16	
	Impact/Vibration resistance [m/s ²] ^{*5}	50/20				
	Actuation type	Ball screw/LESYH□D Ball screw + Belt/LESYH□(R, L)				
	Guide type	Linear guide (Circulating type)				
	Operating temperature range [°C]	5 to 40				
Operating humidity range [%RH]	90 or less (No condensation)					
Electric specifications	Motor size	□42		□56		
	Motor type	Battery-less absolute (Step motor 24 VDC)				
	Encoder (Angular displacement sensor)	Battery-less absolute				
	Power supply voltage [V]	24 VDC ±10%				
	Power [W] ^{*6 *8}	Max. power 48		Max. power 104		
Lock unit specifications	Type	Non-magnetizing lock				
	Holding force [N]	157	78	216	108	
	Power consumption [W] ^{*8}	5				
	Rated voltage [V]	24 VDC ±10%				

*1 Speed changes according to the work load. Check "Speed-Work Load Graph (Guide)" on page 2.

*2 Pushing force accuracy is ±20% (F.S.).

*3 The speed and force may change depending on the cable length, load, and mounting conditions.

Furthermore, if the cable length exceeds 5 m, then it will decrease by up to 10% for each 5 m. (At 15 m: Reduced by up to 20%)

*4 A reference value for correcting an error in reciprocal operation

*5 Vibration resistance: No malfunction occurred in a test ranging between 45 to 2000 Hz. The test was performed in both an axial direction and a perpendicular direction to the lead screw. (The test was performed with the actuator in the initial state.)

Impact resistance: No malfunction occurred when the actuator was tested with a drop tester in both an axial direction and a perpendicular direction to the lead screw. (The test was performed with the actuator in the initial state.)

*6 Indicates the max. power during operation (including the controller)

This value can be used for the selection of the power supply.

*7 With lock only

*8 For an actuator with lock, add the power consumption for the lock.

Weight

With Cover

[kg]

Model	Stroke		
	50	100	150
LESYH16(D, R, L)-□-X171	1.87	2.26	—
LESYH25(D, R, L)-□-X171	3.50	4.10	4.90

Additional Weight

[kg]

Size	16	25
With lock/cover	0.32	0.61

LESYH-X171

Battery-less Absolute (Step Motor 24 VDC)

Dimensions

LESYH25-X171

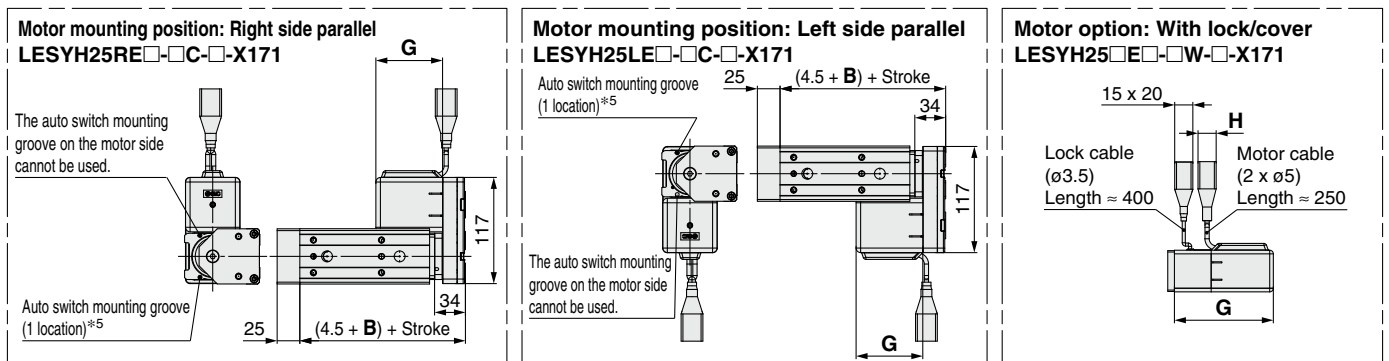
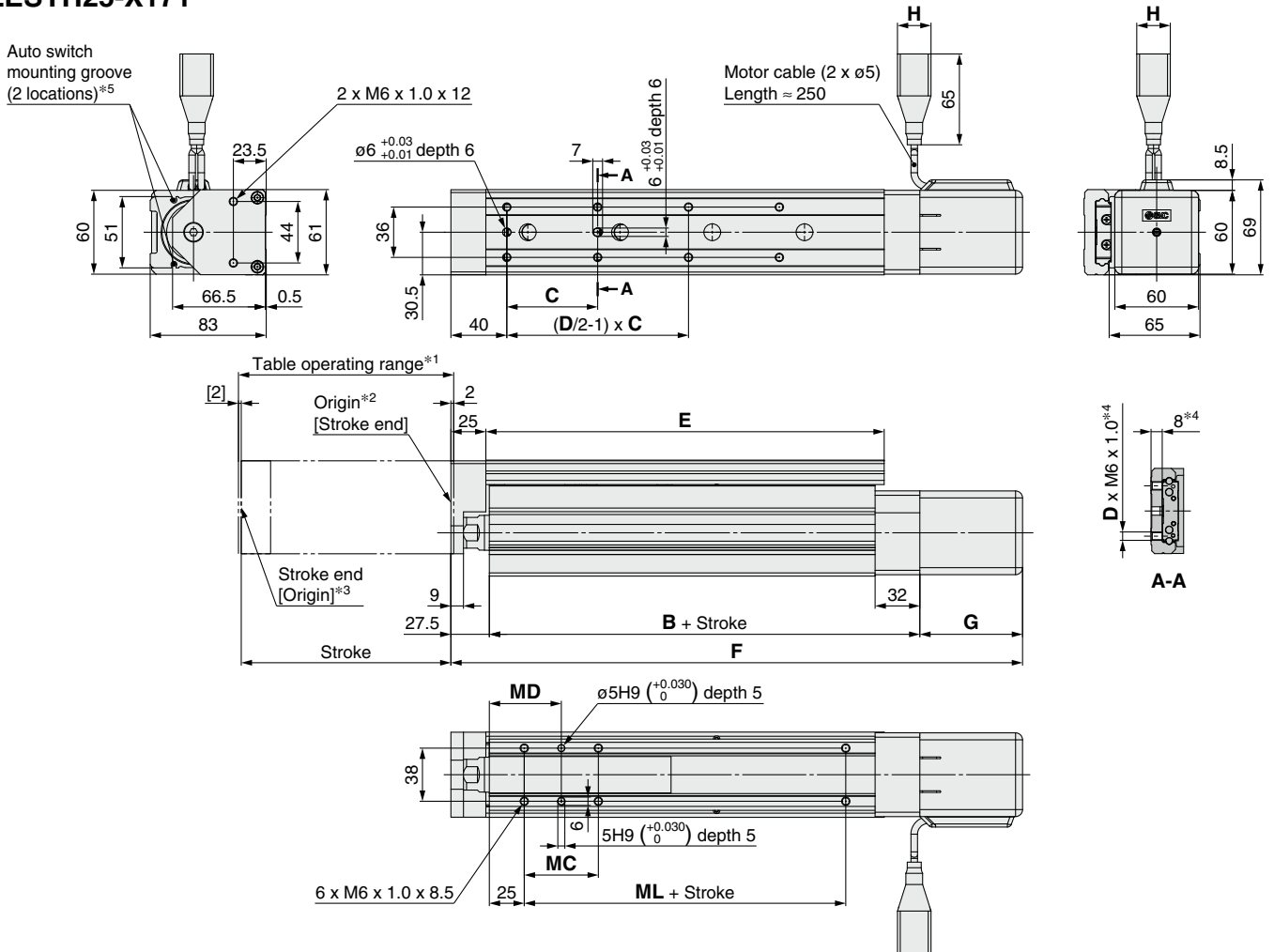

- *1 This is the range within which the table can move when it returns to origin. Make sure workpieces mounted on the table do not interfere with the workpieces and facilities around the table.
- *2 Position after return to origin
- *3 [] for when the direction of return to origin has changed
- *4 If the workpiece retaining screws are too long, they may come in contact with the guide block, resulting in a malfunction. Use screws of a length equal to or shorter than the thread length.
- *5 Order the auto switch for checking the limit and the intermediate signal separately. Applicable to the D-M9□, D-M9□E, and D-M9□W (2-color indicator). For details, refer to the **Web Catalog**.

Dimensions

Model	Stroke	Motor option	B	C	D	E	F	G	H	MC	MD	ML	
LESYH25DE□-50C-□-X171	50	C: With cover	128	75	4	143	279	73.5	24	36	43	50	
LESYH25DE□-100C-□-X171	100		158	65	8	207	329			53	51.5	80	
LESYH25DE□-150C-□-X171	150	W: With lock/cover	128	75	4	143	322	116.5		36	43	50	
LESYH25DE□-50W-□-X171	50		158	65	8	207	372			53	51.5	80	
LESYH25DE□-100W-□-X171	100												
LESYH25DE□-150W-□-X171	150												

LESYH Series Auto Switch Mounting

Auto Switch Mounting Position



Size	Stroke	A	B
16	50	100.5	137.5
	100	150.5	212.5
25	50	108	168
	100	158	232
	150	238	310

[mm]

Auto Switch Mounting

When mounting the auto switches, they should be inserted into the actuator's auto switch mounting groove as shown in the drawing below.

After setting in the mounting position, use a flat head watchmaker's screwdriver to tighten the auto switch mounting screw that is included.

Auto Switch Mounting Screw Tightening Torque [N·m]

Auto switch model	Tightening torque
D-M9□(V) D-M9□W(V) D-M9□E	0.05 to 0.10

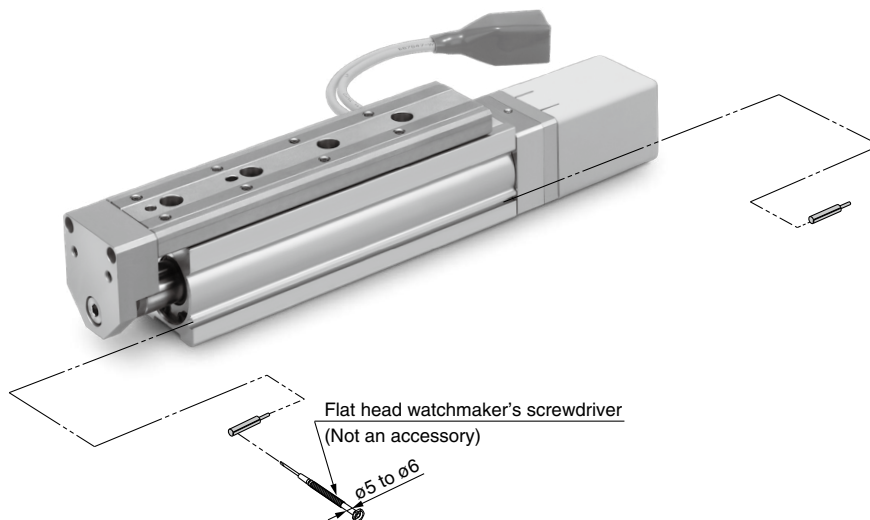

* When tightening the auto switch mounting screw (included with auto switch), use a watchmaker's screwdriver with a handle diameter of about 5 to 6 mm.

Model Selection

LESYH-X171

Auto Switch

JXC□1

JXC51/61

Solid State Auto Switch Direct Mounting Type

D-M9N(V)/D-M9P(V)/D-M9B(V)



Refer to the SMC website for details on products that are compliant with international standards.

Auto Switch Specifications

PLC: Programmable Logic Controller

D-M9□, D-M9□V (With indicator light)						
Auto switch model	D-M9N	D-M9NV	D-M9P	D-M9PV	D-M9B	D-M9BV
Electrical entry direction	In-line	Perpendicular	In-line	Perpendicular	In-line	Perpendicular
Wiring type	3-wire				2-wire	
Output type	NPN		PNP		—	
Applicable load	IC circuit, Relay, PLC				24 VDC relay, PLC	
Power supply voltage	5, 12, 24 VDC (4.5 to 28 V)				—	
Current consumption	10 mA or less				—	
Load voltage	28 VDC or less		—		24 VDC (10 to 28 VDC)	
Load current	40 mA or less				2.5 to 40 mA	
Internal voltage drop	0.8 V or less at 10 mA (2 V or less at 40 mA)				4 V or less	
Leakage current	100 μA or less at 24 VDC				0.8 mA or less	
Indicator light	Red LED illuminates when turned ON.					
Standard	CE marking, RoHS					

Grommet

- 2-wire load current is reduced (2.5 to 40 mA).
- Using flexible cable as standard spec.



Oilproof Flexible Heavy-duty Lead Wire Specifications

Auto switch model		D-M9N(V)	D-M9P(V)	D-M9B(V)
Sheath	Outside diameter [mm]	2.6		
Insulator	Number of cores	3 cores (Brown/Blue/Black)		2 cores (Brown/Blue)
	Outside diameter [mm]	0.88		
Conductor	Effective area [mm ²]	0.15		
	Strand diameter [mm]	0.05		
Minimum bending radius [mm] (Reference values)		17		

Caution

Precautions

Fix the auto switch with the existing screw installed on the auto switch body. The auto switch may be damaged if a screw other than the one supplied is used.

- * Refer to the **Web Catalog** for solid state auto switch common specifications.
- * Refer to the **Web Catalog** for lead wire lengths.

Weight

[g]

Auto switch model		D-M9N(V)	D-M9P(V)	D-M9B(V)
Lead wire length	0.5 m (Nil)	8	7	7
	1 m (M)	14	13	13
	3 m (L)	41	38	38
	5 m (Z)	68	63	63

Dimensions

[mm]

D-M9□

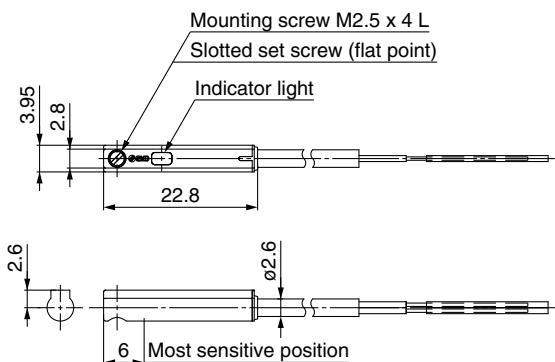

D-M9□V

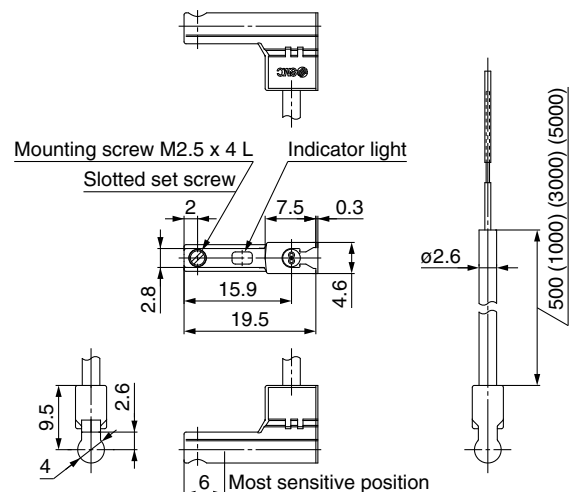

Normally Closed Solid State Auto Switch Direct Mounting Type D-M9NE(V)/D-M9PE(V)/D-M9BE(V)

Refer to the SMC website for details on products that are compliant with international standards.

PLC: Programmable Logic Controller

Auto Switch Specifications

D-M9□E, D-M9□EV (With indicator light)						
Auto switch model	D-M9NE	D-M9NEV	D-M9PE	D-M9PEV	D-M9BE	D-M9BEV
Electrical entry direction	In-line	Perpendicular	In-line	Perpendicular	In-line	Perpendicular
Wiring type	3-wire				2-wire	
Output type	NPN		PNP		—	
Applicable load	IC circuit, Relay, PLC				24 VDC relay, PLC	
Power supply voltage	5, 12, 24 VDC (4.5 to 28 V)				—	
Current consumption	10 mA or less				—	
Load voltage	28 VDC or less		—		24 VDC (10 to 28 VDC)	
Load current	40 mA or less				2.5 to 40 mA	
Internal voltage drop	0.8 V or less at 10 mA (2 V or less at 40 mA)				4 V or less	
Leakage current	100 μA or less at 24 VDC				0.8 mA or less	
Indicator light	Red LED illuminates when turned ON.					
Standard	CE marking, RoHS					

Oilproof Flexible Heavy-duty Lead Wire Specifications

Auto switch model	D-M9NE(V)	D-M9PE(V)	D-M9BE(V)
Sheath	Outside diameter [mm]		
	2.6		
Insulator	Number of cores		2 cores (Brown/Blue)
	Outside diameter [mm]		0.88
Conductor	Effective area [mm ²]		0.15
	Strand diameter [mm]		0.05
Minimum bending radius [mm] (Reference values)			
17			

* Refer to the **Web Catalog** for solid state auto switch common specifications.
* Refer to the **Web Catalog** for lead wire lengths.

Weight

Auto switch model	D-M9NE(V)	D-M9PE(V)	D-M9BE(V)
Lead wire length	0.5 m (Nil)	8	7
	1 m (M)*1	14	13
	3 m (L)	41	38
	5 m (Z)*1	68	63

*1 The 1 m and 5 m options are produced upon receipt of order.

Grommet

- Output signal turns on when no magnetic force is detected.
- Can be used for the actuator adopted by the solid state auto switch D-M9 series (excluding special order products)

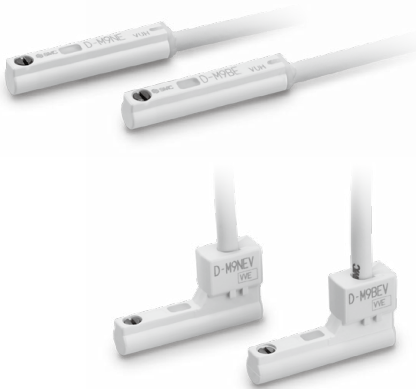

Caution

Precautions

Fix the auto switch with the existing screw installed on the auto switch body. The auto switch may be damaged if a screw other than the one supplied is used.

Dimensions

D-M9□E

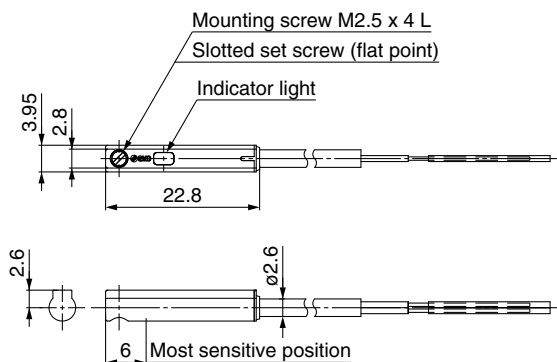

D-M9□EV

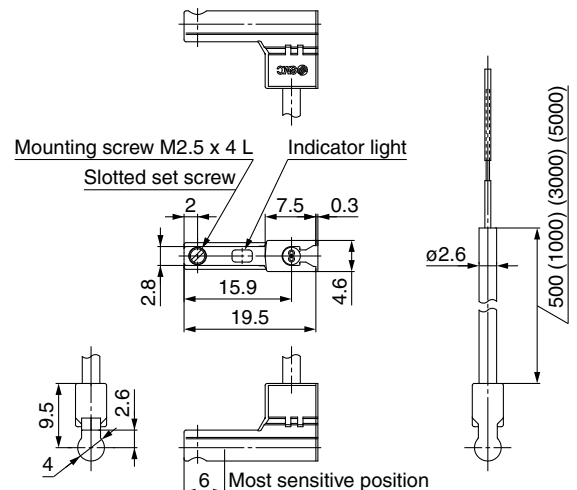

2-Color Indicator Solid State Auto Switch Direct Mounting Type

D-M9NW(V)/D-M9PW(V)/D-M9BW(V)



Refer to the SMC website for details on products that are compliant with international standards.

Auto Switch Specifications

PLC: Programmable Logic Controller

D-M9□W, D-M9□WV (With indicator light)						
Auto switch model	D-M9NW	D-M9NWV	D-M9PW	D-M9PWV	D-M9BW	D-M9BWV
Electrical entry direction	In-line	Perpendicular	In-line	Perpendicular	In-line	Perpendicular
Wiring type	3-wire				2-wire	
Output type	NPN		PNP		—	
Applicable load	IC circuit, Relay, PLC				24 VDC relay, PLC	
Power supply voltage	5, 12, 24 VDC (4.5 to 28 V)				—	
Current consumption	10 mA or less				—	
Load voltage	28 VDC or less		—		24 VDC (10 to 28 VDC)	
Load current	40 mA or less				2.5 to 40 mA	
Internal voltage drop	0.8 V or less at 10 mA (2 V or less at 40 mA)				4 V or less	
Leakage current	100 μA or less at 24 VDC				0.8 mA or less	
Indicator light	Operating range Red LED illuminates. Proper operating range Green LED illuminates.					
Standard	CE marking, RoHS					

Grommet

- 2-wire load current is reduced (2.5 to 40 mA).
- Using flexible cable as standard spec.
- The proper operating range can be determined by the color of the light. (Red → Green ← Red)



Caution

Precautions

Fix the auto switch with the existing screw installed on the auto switch body. The auto switch may be damaged if a screw other than the one supplied is used.

Oilproof Flexible Heavy-duty Lead Wire Specifications

Auto switch model		D-M9NW(V)	D-M9PW(V)	D-M9BW(V)
Sheath	Outside diameter [mm]	2.6		
Insulator	Number of cores	3 cores (Brown/Blue/Black)		2 cores (Brown/Blue)
	Outside diameter [mm]	0.88		
Conductor	Effective area [mm ²]	0.15		
	Strand diameter [mm]	0.05		
Minimum bending radius [mm] (Reference values)		17		

- * Refer to the **Web Catalog** for solid state auto switch common specifications.
- * Refer to the **Web Catalog** for lead wire lengths.

Weight

[g]

Auto switch model		D-M9NW(V)	D-M9PW(V)	D-M9BW(V)
Lead wire length	0.5 m (Nil)	8	7	7
	1 m (M)	14	13	13
	3 m (L)	41	38	38
	5 m (Z)	68	63	63

Dimensions

[mm]

D-M9□W

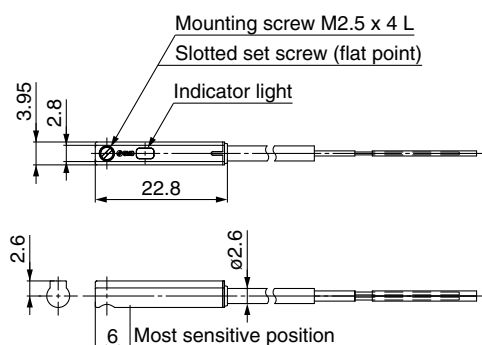

D-M9□WV

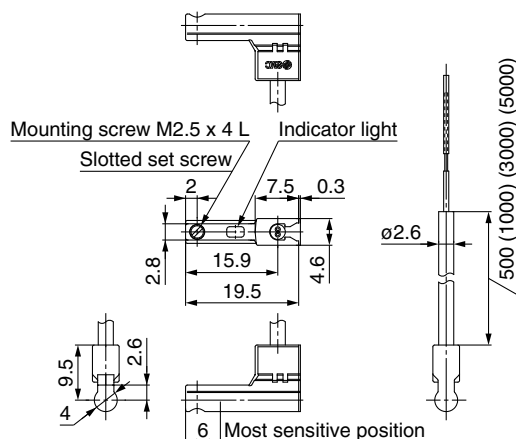

Step Motor Controller

JXCE1/91/P1/D1/L1/M1 Series



Model Selection
LESYH-X171
Auto Switch
JXC□1
JXC51/61

How to Order

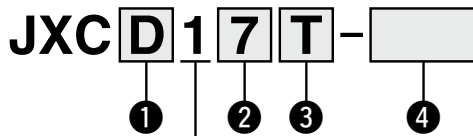

For single axis



EtherCAT → EtherNet/IP → PROFINET → DeviceNet → IO-Link → CC-Link

1 Communication protocol

E	EtherCAT®
9	EtherNet/IP™
P	PROFINET
D	DeviceNet™
L	IO-Link
M	CC-Link

2 Mounting

7	Screw mounting
8*1	DIN rail

*1 The DIN rail is not included. It must be ordered separately. (Refer to page 21.)

3 Option

Nil	Without option
S	With straight type communication plug
T	With T-branch type communication plug

* Select "Nil" for anything other than JXCD1 and JXCM1.

4 Actuator part number

Without cable specifications and actuator options
Example: Enter "LESYH16DEA-50-X171" for the LESYH16DEA-50C-R1□□-X171.

The controller is sold as single unit after the compatible actuator is set.

Confirm that the combination of the controller and actuator is correct.

- ① Check the actuator label for the model number. This number should match that of the controller.

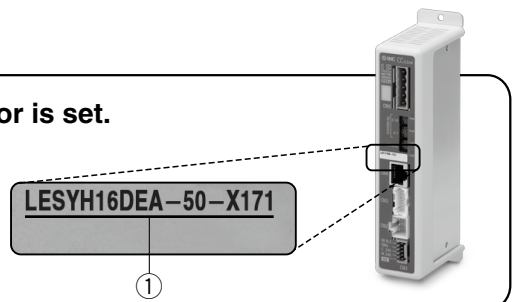

* Refer to the operation manual for using the products. Please download it via our website, <https://www.smcworld.com>

JXCE1/91/P1/D1/L1/M1 Series

Specifications

Model		JXCE1	JXC91	JXCP1	JXCD1	JXCL1	JXCM1	
Network		EtherCAT®	EtherNet/IP™	PROFINET	DeviceNet™	IO-Link	CC-Link	
Compatible motor		Step motor (Servo/24 VDC)						
Power supply		Power voltage: 24 VDC ±10%						
Current consumption (Controller)		200 mA or less	130 mA or less	200 mA or less	100 mA or less	100 mA or less	100 mA or less	
Compatible encoder		Battery-less absolute (4096 pulse/rotation)						
Communication specifications	Applicable system	Protocol	EtherCAT®*2	EtherNet/IP™*2	PROFINET*2	DeviceNet™	IO-Link	CC-Link
		Version*1	Conformance Test Record V.1.2.6	Volume 1 (Edition 3.14) Volume 2 (Edition 1.15)	Specification Version 2.32	Volume 1 (Edition 3.14) Volume 3 (Edition 1.13)	Version 1.1 Port Class A	Ver. 1.10
		Communication speed	100 Mbps*2	10/100 Mbps*2 (Automatic negotiation)	100 Mbps*2	125/250/500 kbps	230.4 kbps (COM3)	156 kbps, 625 kbps, 2.5 Mbps, 5 Mbps, 10 Mbps
		Configuration file*3	ESI file	EDS file	GSDML file	EDS file	IODD file	CSP+ file
		I/O occupation area	Input 20 bytes Output 36 bytes	Input 36 bytes Output 36 bytes	Input 36 bytes Output 36 bytes	Input 4, 10, 20 bytes Output 4, 12, 20, 36 bytes	Input 14 bytes Output 22 bytes	1 station, 2 stations, 4 stations
		Terminating resistor	Not included					
Memory		EEPROM						
LED indicator		PWR, RUN, ALM, ERR	PWR, ALM, MS, NS	PWR, ALM, SF, BF	PWR, ALM, MS, NS	PWR, ALM, COM	PWR, ALM, L ERR, L RUN	
Cable length [m]		Actuator cable: 20 or less						
Cooling system		Natural air cooling						
Operating temperature range [°C]		0 to 55 (No freezing)						
Operating humidity range [%RH]		90 or less (No condensation)						
Insulation resistance [MΩ]		Between all external terminals and the case: 50 (500 VDC)						
Weight [g]		220 (Screw mounting) 240 (DIN rail mounting)	210 (Screw mounting) 230 (DIN rail mounting)	220 (Screw mounting) 240 (DIN rail mounting)	210 (Screw mounting) 230 (DIN rail mounting)	190 (Screw mounting) 210 (DIN rail mounting)	170 (Screw mounting) 190 (DIN rail mounting)	

*1 Please note that versions are subject to change.

*2 Use a shielded communication cable with CAT5 or higher for the PROFINET, EtherNet/IP™, and EtherCAT®.

*3 The files can be downloaded from the SMC website.

■ Trademark

EtherNet/IP™ is a trademark of ODVA.

DeviceNet™ is a trademark of ODVA.

EtherCAT® is registered trademark and patented technology, licensed by Beckhoff Automation GmbH, Germany.

Example of Operation Command

In addition to the step data input of 64 points maximum in each communication protocol, the changing of each parameter can be performed in real time via numerical data defined operation.
 * Numerical values other than "Moving force," "Area 1," and "Area 2" can be used to perform operation under numerical instructions from JXCL1.

<Application example> Movement between 2 points

No.	Movement mode	Speed	Position	Acceleration	Deceleration	Pushing force	Trigger LV	Pushing speed	Moving force	Area 1	Area 2	In position
0	1: Absolute	100	10	3000	3000	0	0	0	100	0	0	0.50
1	1: Absolute	100	100	3000	3000	0	0	0	100	0	0	0.50

<Step no. defined operation>

Sequence 1: Servo ON instruction

Sequence 2: Instruction to return to origin

Sequence 3: Specify step data No. 0 to input the DRIVE signal.

Sequence 4: Specify step data No. 1 after the DRIVE signal has been temporarily turned OFF to input the DRIVE signal.

<Numerical data defined operation>

Sequence 1: Servo ON instruction

Sequence 2: Instruction to return to origin

Sequence 3: Specify step data No. 0 and turn ON the input instruction flag (position). Input 10 in the target position. Subsequently the start flag turns ON.

Sequence 4: Turn ON step data No. 0 and the input instruction flag (position) to change the target position to 100 while the start flag is ON.

The same operation can be performed with any operation command.

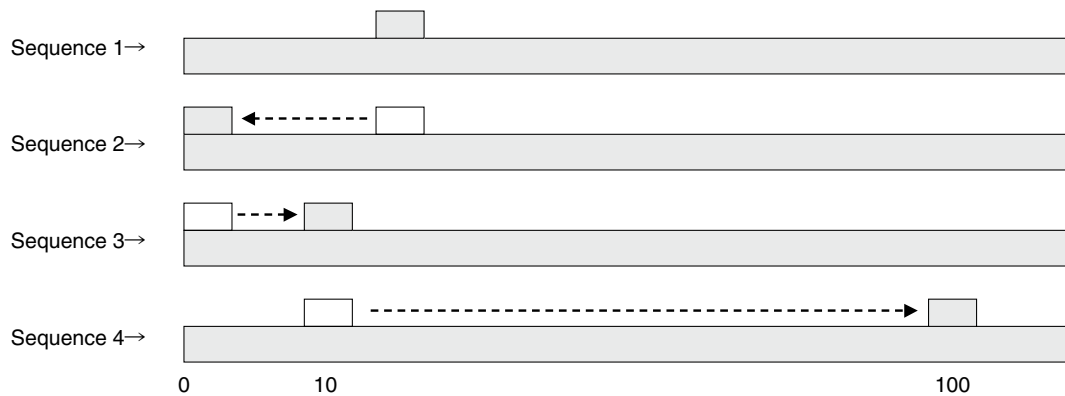

JXCE1/91/P1/D1/L1/M1 Series

Dimensions

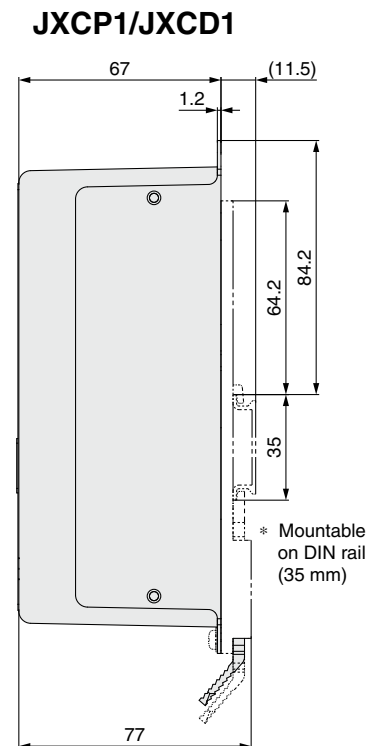
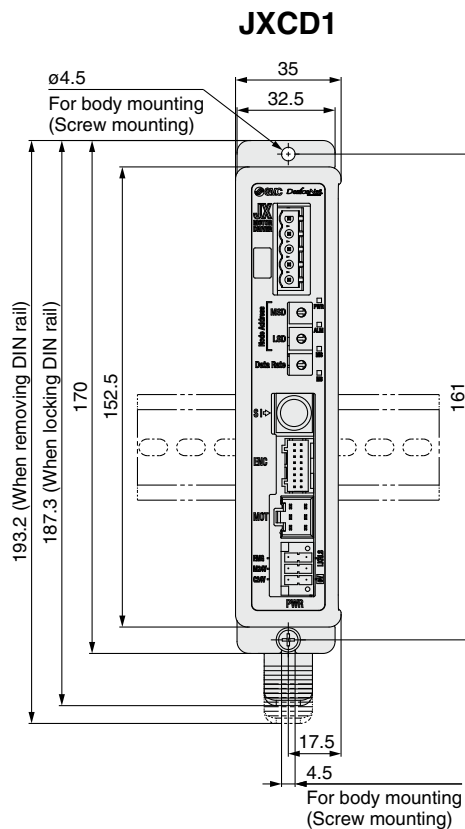
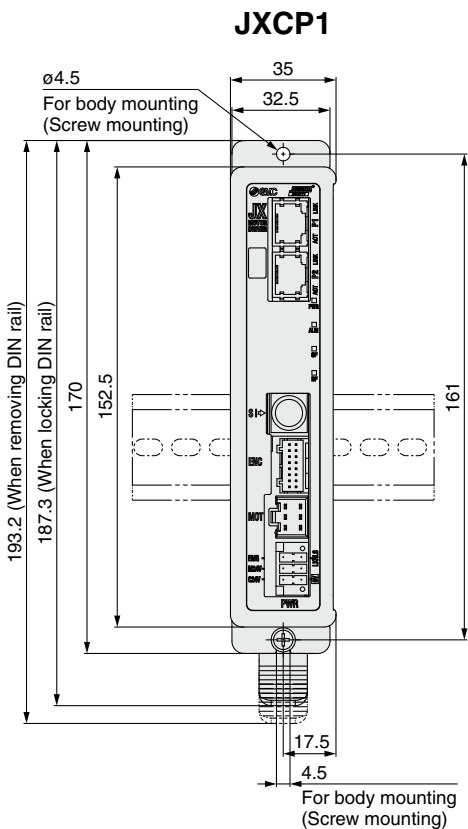
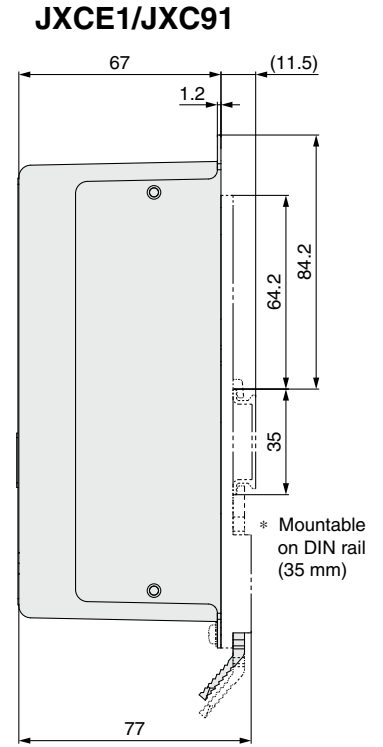
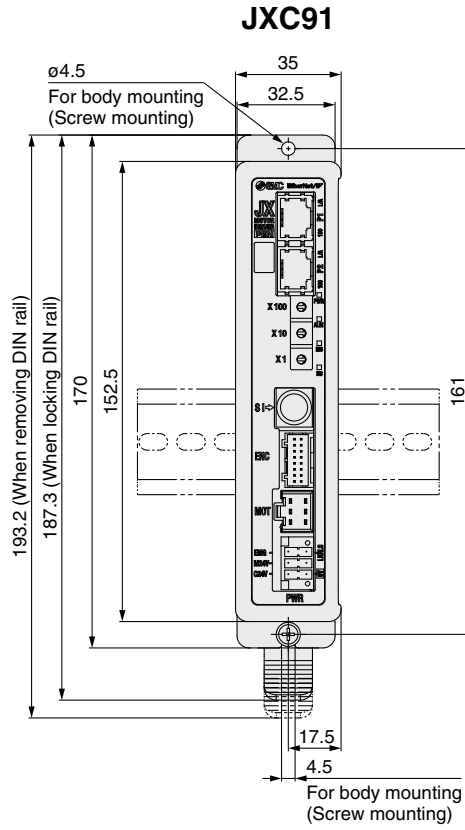
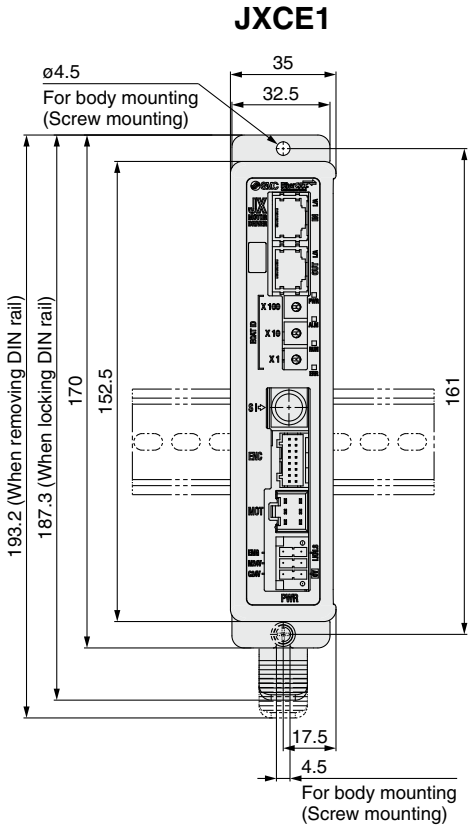

Dimensions

JXCL1

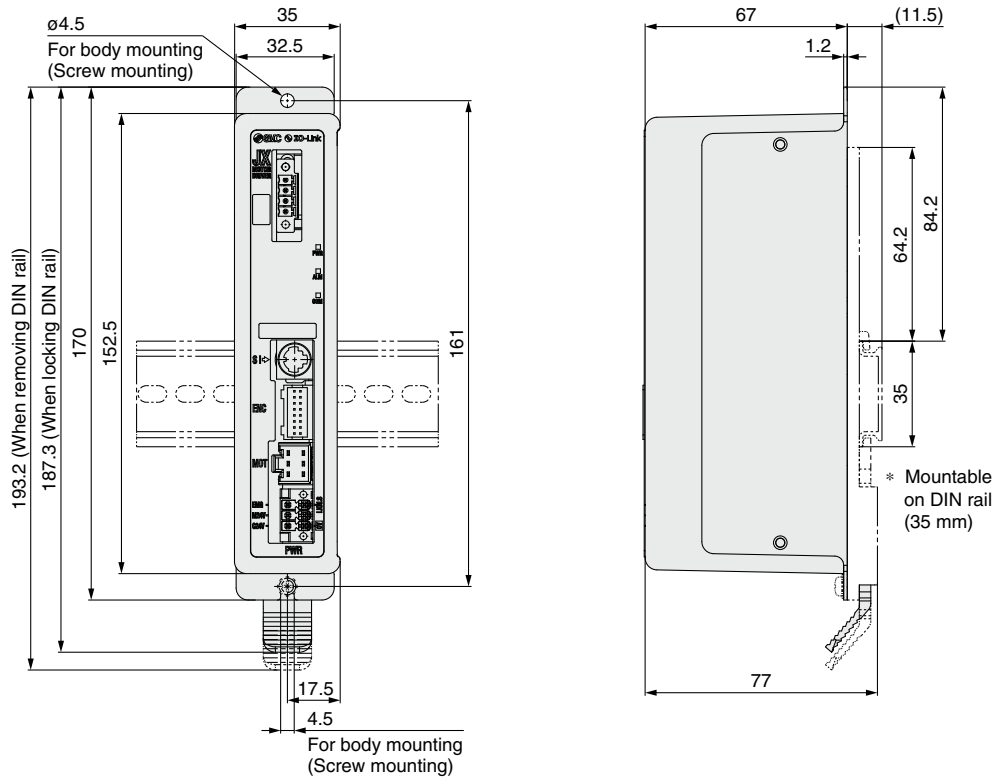

JXCM1

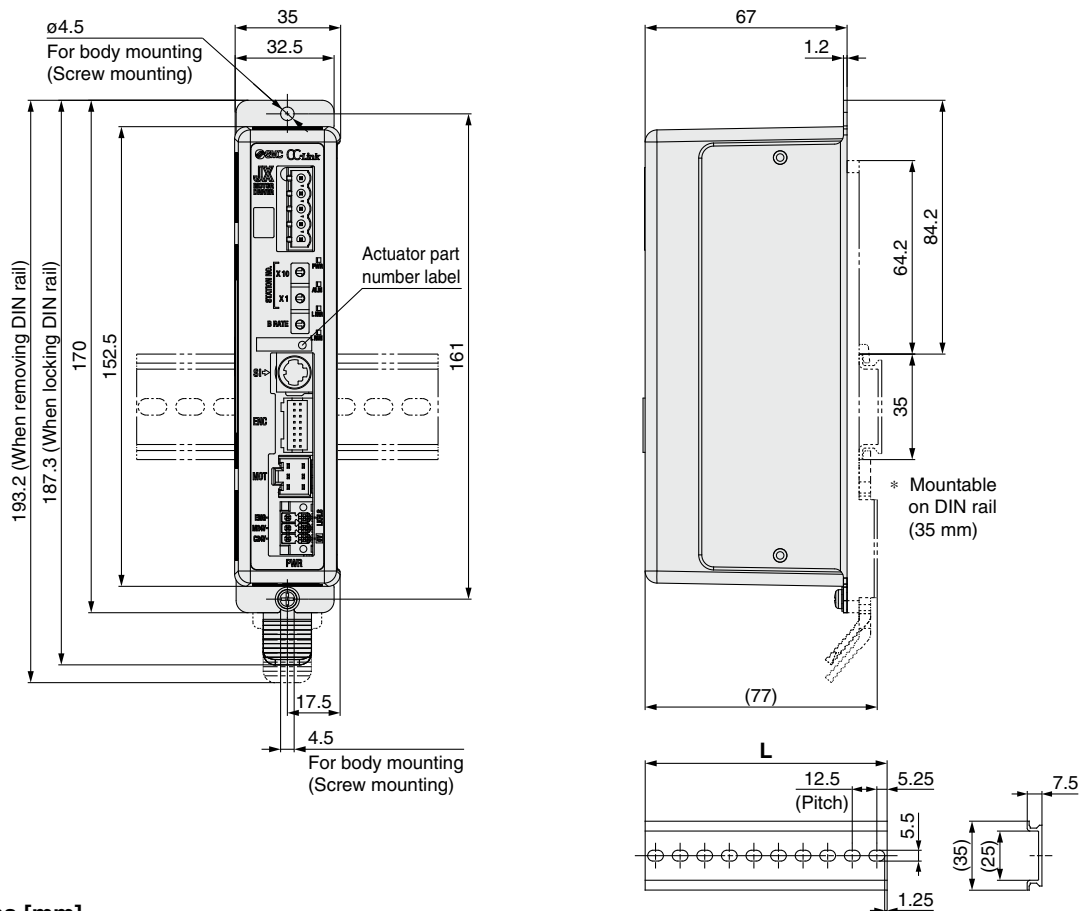

L Dimensions [mm]

No.	1	2	3	4	5	6	7	8	9	10	11	12	13	14	15	16	17	18	19	20
L	23	35.5	48	60.5	73	85.5	98	110.5	123	135.5	148	160.5	173	185.5	198	210.5	223	235.5	248	260.5
No.	21	22	23	24	25	26	27	28	29	30	31	32	33	34	35	36	37	38	39	40
L	273	285.5	298	310.5	323	335.5	348	360.5	373	385.5	398	410.5	423	435.5	448	460.5	473	485.5	498	510.5

JXCE1/91/P1/D1/L1/M1 Series

Options

■ Communication cable for controller setting

- Controller setting software
 - USB driver
- Download from SMC's website:
<https://www.smcworld.com>

Hardware Requirements

OS	Windows®7, Windows®8.1, Windows®10
Communication interface	USB 1.1 or USB 2.0 ports
Display	1024 x 768 or more

* Windows®7, Windows®8.1, and Windows®10 are registered trademarks of Microsoft Corporation in the United States.

① Communication cable JXC-W2A-C

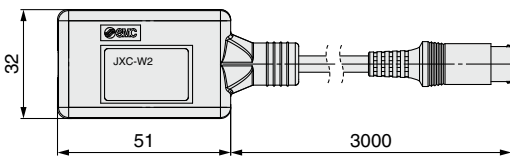

* It can be connected to the controller directly.

② USB cable LEC-W2-U

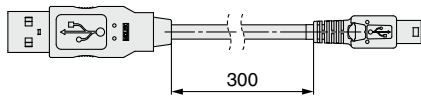

■ DIN rail mounting adapter LEC-3-D0

- * With 2 mounting screws

This should be used when the DIN rail mounting adapter is mounted onto a screw mounting type controller afterward.

■ DIN rail AXT100-DR-□

- * For □, enter a number from the No. line in the table on page 20. Refer to the dimension drawings on page 20 for the mounting dimensions.

■ Power supply plug JXC-CPW

* The power supply plug is an accessory.

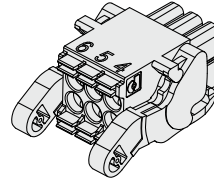

① C24V	④ 0V
② M24V	⑤ N.C.
③ EMG	⑥ LK RLS

Power supply plug

Terminal name	Function	Details
0V	Common supply (-)	M24V terminal/C24V terminal/EMG terminal/LK RLS terminal are common (-).
M24V	Motor power supply (+)	Motor power supply (+) of the controller
C24V	Control power supply (+)	Control power supply (+) of the controller
EMG	Stop (+)	Connection terminal of the external stop circuit
LK RLS	Lock release (+)	Connection terminal of the lock release switch

■ Communication plug connector

For DeviceNet™

Straight type JXC-CD-S

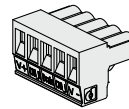

T-branch type JXC-CD-T

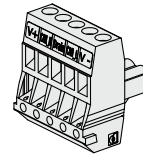

Communication plug connector for DeviceNet™

Terminal name	Details
V+	Power supply (+) for DeviceNet™
CAN_H	Communication wire (High)
Drain	Grounding wire/Shielded wire
CAN_L	Communication wire (Low)
V-	Power supply (-) for DeviceNet™

For IO-Link

Straight type JXC-CL-S

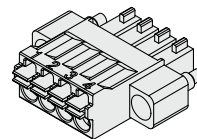

Communication plug connector for IO-Link

Terminal no.	Terminal name	Details
1	L+	+24 V
2	NC	N/A
3	L-	0 V
4	C/Q	IO-Link signal

* The communication plug connector for IO-Link is an accessory.

For CC-Link

Straight type LEC-CMJ-S



T-branch type LEC-CMJ-T



Communication plug connector for CC-Link

Terminal name	Details
DA	CC-Link communication line A
DB	CC-Link communication line B
DG	CC-Link ground line
SLD	CC-Link shield
FG	Frame ground

■ Conversion cable P5062-5 (Cable length: 300 mm)

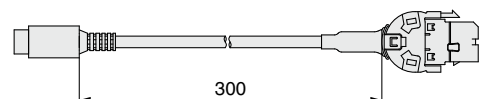

* To connect the teaching box (LEC-T1-3□G□) or controller setting kit (LEC-W2) to the controller, a conversion cable is required.

Controller (Step Data Input Type)

JXC51/61 Series



Parallel I/O

How to Order

JXC **5** 1 **7** **1** - **□**

① ② ③ ④

① Parallel I/O type

5	NPN
6	PNP

② Mounting

7	Screw mounting
8*1	DIN rail

*1 The DIN rail is not included.
Order it separately.

③ I/O cable length [m]

Nil	None
1	1.5
3	3
5	5

④ Actuator part number

Without cable specifications and actuator options
Example: Enter "LESYH16DEA-50-X171" for the
LESYH16DEA-50C-R1□□-X171.

The controller is sold as single unit after the compatible actuator is set.

Confirm that the combination of the controller and actuator is correct.

<Check the following before use.>

- ① Check the actuator label for the model number. This number should match that of the controller.
- ② Check that the Parallel I/O configuration matches (NPN or PNP).

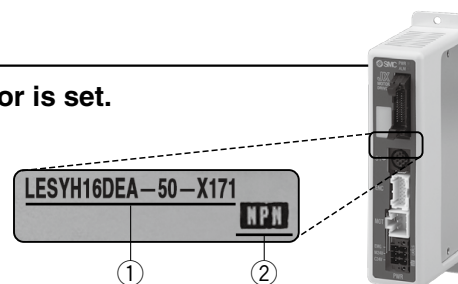

* Refer to the operation manual for using the products. Please download it via our website, <https://www.smcworld.com>

Specifications

Model	JXC51 JXC61
Compatible motor	Step motor (Servo/24 VDC)
Power supply	Power voltage: 24 VDC ±10%
Current consumption (Controller)	100 mA or less
Compatible encoder	Battery-less absolute (4096 pulse/rotation)
Parallel input	11 inputs (Photo-coupler isolation)
Parallel output	13 outputs (Photo-coupler isolation)
Serial communication	RS485 (Only for the LEC-T1 and JXC-W2)
Memory	EEPROM
LED indicator	PWR, ALM
Cable length [m]	Actuator cable: 20 or less
Cooling system	Natural air cooling
Operating temperature range [°C]	0 to 55°C
Operating humidity range [%RH]	90 or less (No condensation)
Insulation resistance [MΩ]	Between all external terminals and the case: 50 (50 VDC)
Weight [g]	150 (Screw mounting), 170 (DIN rail mounting)

JXC51/61 Series

How to Mount

a) Screw mounting (JXC□1□□-□) (Installation with two M4 screws)

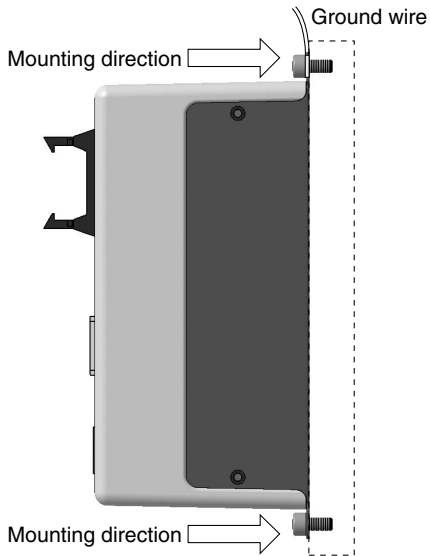

b) DIN rail mounting (JXC□1□□D-□) (Installation with the DIN rail)

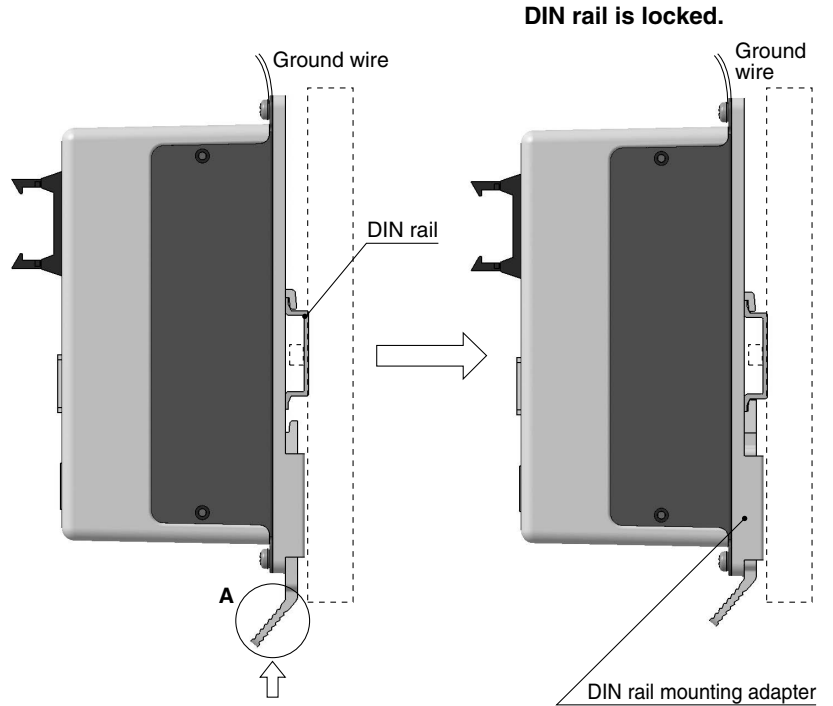

Hook the controller on the DIN rail and press the lever of section A in the arrow direction to lock it.

* When size 25 or more of the LE series are used, the space between the controllers should be 10 mm or more.

DIN rail AXT100-DR-□

* For □, enter a number from the No. line in the table below.
Refer to the dimension drawings on page 24 for the mounting dimensions.

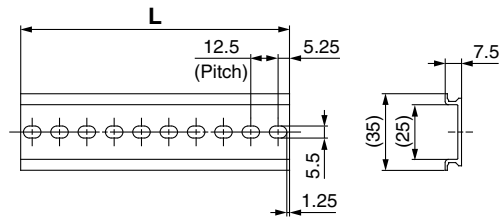

L Dimensions [mm]

No.	1	2	3	4	5	6	7	8	9	10	11	12	13	14	15	16	17	18	19	20
L	23	35.5	48	60.5	73	85.5	98	110.5	123	135.5	148	160.5	173	185.5	198	210.5	223	235.5	248	260.5
No.	21	22	23	24	25	26	27	28	29	30	31	32	33	34	35	36	37	38	39	40
L	273	285.5	298	310.5	323	335.5	348	360.5	373	385.5	398	410.5	423	435.5	448	460.5	473	485.5	498	510.5

DIN rail mounting adapter LEC-D0 (with 2 mounting screws)

This should be used when the DIN rail mounting adapter is mounted onto a screw mounting type controller afterward.

Dimensions

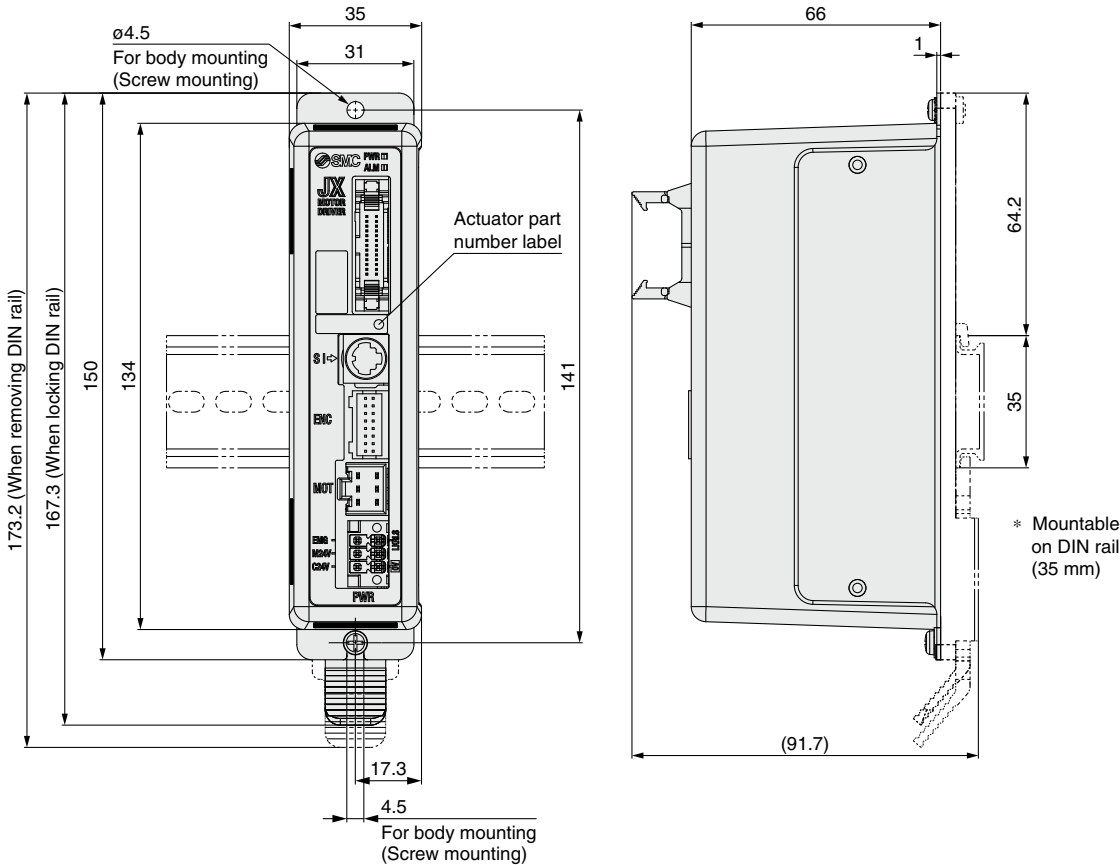

Model Selection

LESYH-X171

Auto Switch

JXC□1

JXC51/61

JXC51/61 Series

Wiring Example 1

Parallel I/O Connector

- * When you connect a PLC to the parallel I/O connector, use the I/O cable (LEC-CN5-□).
- * The wiring changes depending on the type of parallel I/O (NPN or PNP).

Wiring diagram

JXC51□□-□ (NPN)

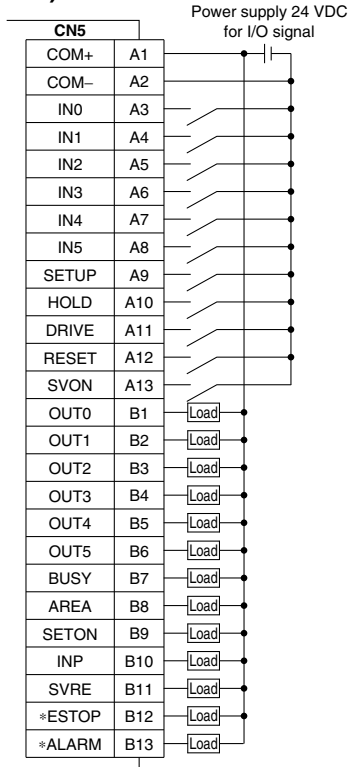

JXC61□□-□ (PNP)

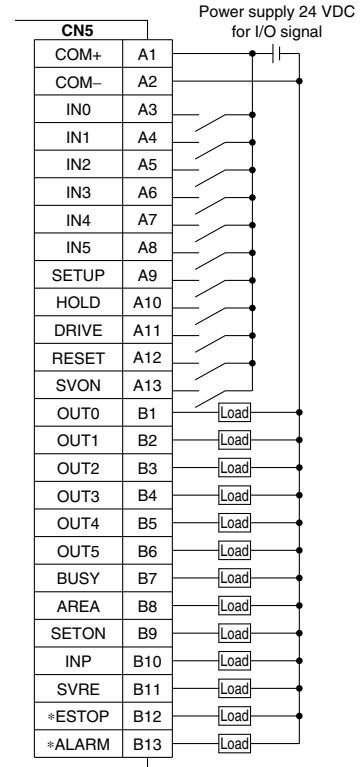

Input Signal

Name	Details
COM+	Connects the power supply 24 V for input/output signal
COM-	Connects the power supply 0 V for input/output signal
IN0 to IN5	Step data specified bit no. (Input is instructed by combining IN0 to 5.)
SETUP	Instruction to return to origin
HOLD	Temporarily stops operation
DRIVE	Instruction to drive
RESET	Resets alarm and interrupts operation
SVON	Servo ON instruction

Output Signal

Name	Details
OUT0 to OUT5	Outputs the step data no. during operation
BUSY	Outputs when the actuator is moving
AREA	Outputs within the step data area output setting range
SETON	Outputs when returning to origin
INP	Outputs when target position or target force is reached (Turns on when the positioning or pushing is completed.)
SVRE	Outputs when servo is on
ESTOP ¹	OFF when EMG stop is instructed
ALARM ¹	OFF when alarm is generated

*1 Signal of negative-logic circuit (N.C.)

Step Data Setting

1. Step data setting for positioning

In this setting, the actuator moves toward and stops at the target position.

The following diagram shows the setting items and operation. The setting items and set values for this operation are stated below.

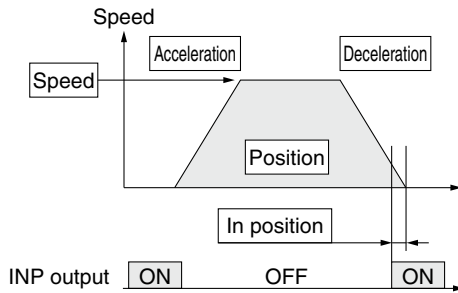

◎ : Need to be set.
○ : Need to be adjusted as required.
— : Setting is not required.

Step Data (Positioning)

Necessity	Item	Details
◎	Movement MOD	When the absolute position is required, set Absolute. When the relative position is required, set Relative.
◎	Speed	Transfer speed to the target position
◎	Position	Target position
○	Acceleration	Parameter which defines how rapidly the actuator reaches the speed set. The higher the set value, the faster it reaches the speed set.
○	Deceleration	Parameter which defines how rapidly the actuator comes to stop. The higher the set value, the quicker it stops.
◎	Pushing force	Set 0. (If values 1 to 100 are set, the operation will be changed to the pushing operation.)
—	Trigger LV	Setting is not required.
—	Pushing speed	Setting is not required.
○	Moving force	Max. torque during the positioning operation (No specific change is required.)
○	Area 1, Area 2	Condition that turns on the AREA output signal.
○	In position	Condition that turns on the INP output signal. When the actuator enters the range of [in position], the INP output signal turns on. (It is unnecessary to change this from the initial value.) When it is necessary to output the arrival signal before the operation is completed, make the value larger.

2. Step data setting for pushing

The actuator moves toward the pushing start position, and when it reaches that position, it starts pushing with the set force or less.

The following diagram shows the setting items and operation. The setting items and set values for this operation are stated below.

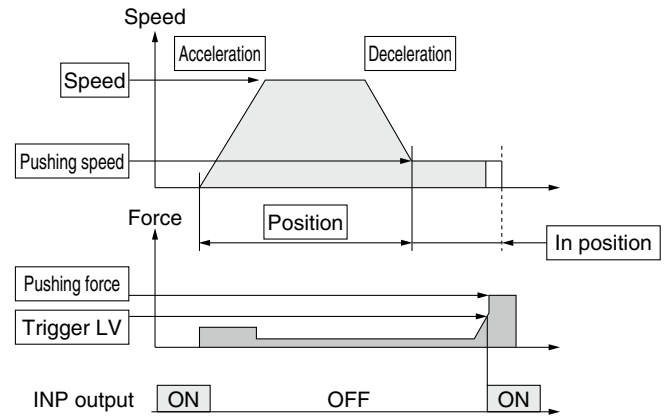

◎ : Need to be set.
○ : Need to be adjusted as required.

Step Data (Pushing)

Necessity	Item	Details
◎	Movement MOD	When the absolute position is required, set Absolute. When the relative position is required, set Relative.
◎	Speed	Transfer speed to the pushing start position
◎	Position	Pushing start position
○	Acceleration	Parameter which defines how rapidly the actuator reaches the speed set. The higher the set value, the faster it reaches the speed set.
○	Deceleration	Parameter which defines how rapidly the actuator comes to stop. The higher the set value, the quicker it stops.
◎	Pushing force	Pushing force ratio is defined. The setting range differs depending on the electric actuator type. Refer to the operation manual for the electric actuator.
◎	Trigger LV	Condition that turns on the INP output signal. The INP output signal turns on when the generated force exceeds the value. Trigger level should be the pushing force or less.
○	Pushing speed	Pushing speed during pushing. When the speed is set fast, the electric actuator and workpieces might be damaged due to the impact when they hit the end, so this set value should be smaller. Refer to the operation manual for the electric actuator.
○	Moving force	Max. torque during the positioning operation (No specific change is required.)
○	Area 1, Area 2	Condition that turns on the AREA output signal.
◎	In position	Transfer distance during pushing. If the transferred distance exceeds the setting, it stops even if it is not pushing. If the transfer distance is exceeded, the INP output signal will not turn on.

JXC51/61 Series

Signal Timing

Return to Origin

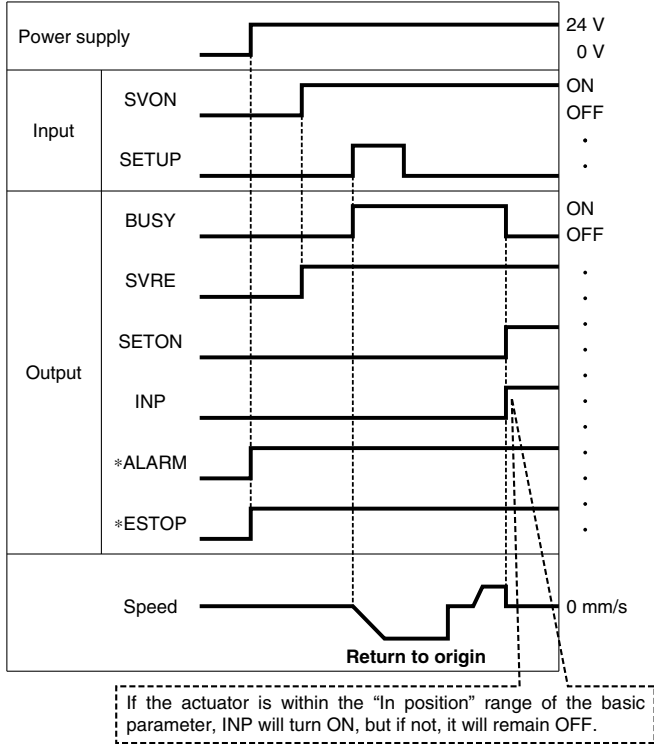

* *ALARM* and *ESTOP* are expressed as negative-logic circuits.

Positioning Operation

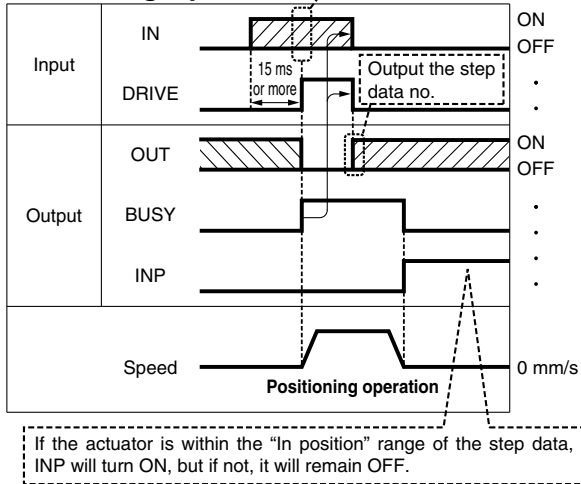

* "OUT" is output when "DRIVE" is changed from ON to OFF.
 (When power supply is applied, "DRIVE" or "RESET" is turned ON or *ESTOP* is turned OFF, all of the "OUT" outputs are OFF.)

HOLD

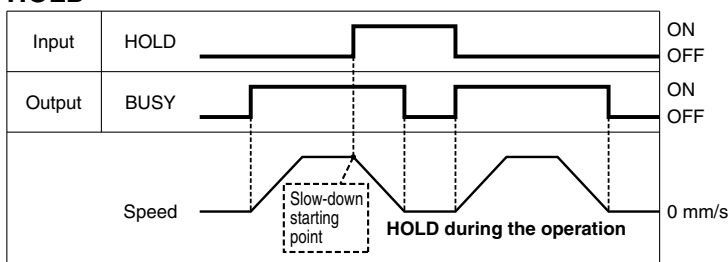

* When the actuator is within the "In position" range in the pushing operation, it does not stop even if HOLD signal is input.

Pushing Operation

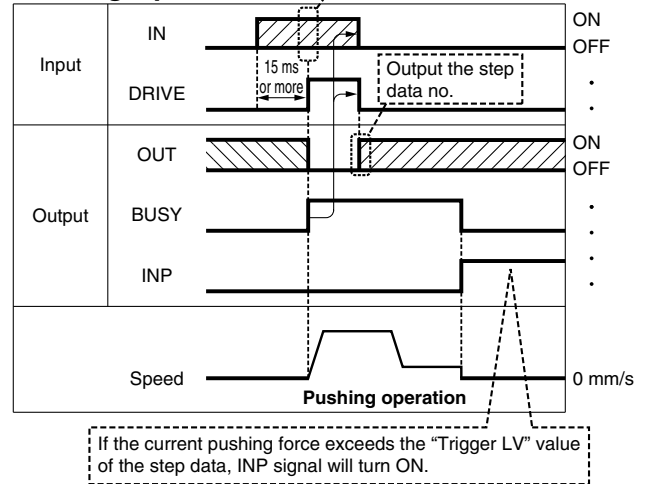

Reset

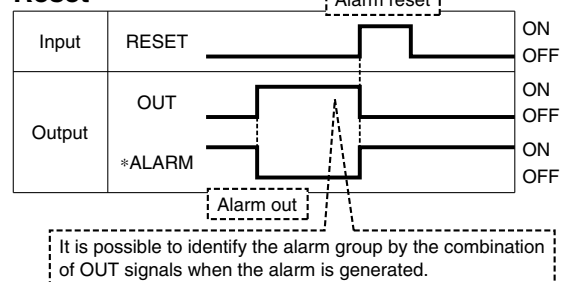

* *ALARM* is expressed as a negative-logic circuit.

Options

Power supply plug JXC-CPW

* The power supply plug is an accessory.
 <Applicable cable size> AWG20 (0.5 mm²), cover diameter 2.0 mm or less

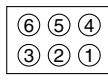
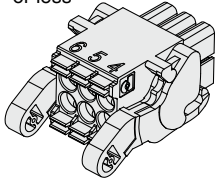

- ① C24V
- ② M24V
- ③ EMG
- ④ 0V
- ⑤ N.C.
- ⑥ LK RLS

Power supply plug terminal

Terminal name	Function	Details
0V	Common supply (-)	M24V terminal/C24V terminal/EMG terminal/LK RLS terminal are common (-).
M24V	Motor power supply (+)	Motor power supply (+) of the controller
C24V	Control power supply (+)	Control power supply (+) of the controller
EMG	Stop (+)	Connection terminal of the external stop circuit
LK RLS	Lock release (+)	Connection terminal of the lock release switch

Communication cable for controller setting

- Controller setting software
 - USB driver
- Download from SMC's website:
<https://www.smcworld.com>

Hardware Requirements

OS	Windows [®] 7, Windows [®] 8.1, Windows [®] 10
Communication interface	USB 1.1 or USB 2.0 ports
Display	1024 x 768 or more

* Windows[®]7, Windows[®]8.1, and Windows[®]10 are registered trademarks of Microsoft Corporation in the United States.

① Communication cable JXC-W2A-C

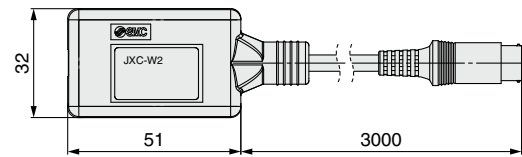

* It can be connected to the controller directly.

② USB cable LEC-W2-U

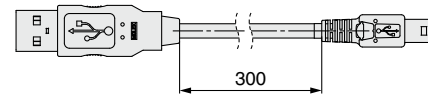

Conversion cable P5062-5 (Cable length: 300 mm)

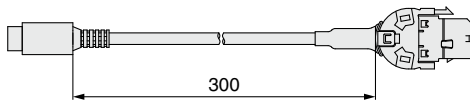

* To connect the teaching box (LEC-T1-3□G□) or controller setting kit (LEC-W2) to the controller, a conversion cable is required.

I/O cable

LEC-CN5-1

Cable length (L) [m]

1	1.5
3	3
5	5

* Conductor size: AWG28

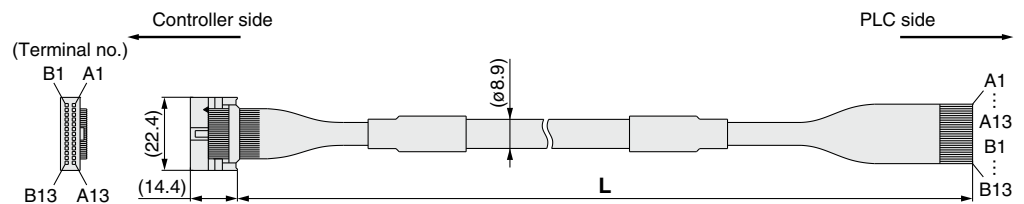

Connector pin no.	Insulation color	Dot mark	Dot color
A1	Light brown	■	Black
A2	Light brown	■	Red
A3	Yellow	■	Black
A4	Yellow	■	Red
A5	Light green	■	Black
A6	Light green	■	Red
A7	Gray	■	Black
A8	Gray	■	Red
A9	White	■	Black
A10	White	■	Red
A11	Light brown	■ ■	Black
A12	Light brown	■ ■	Red
A13	Yellow	■ ■	Black

Connector pin no.	Insulation color	Dot mark	Dot color
B1	Yellow	■ ■	Red
B2	Light green	■ ■	Black
B3	Light green	■ ■	Red
B4	Gray	■ ■	Black
B5	Gray	■ ■	Red
B6	White	■ ■	Black
B7	White	■ ■	Red
B8	Light brown	■ ■ ■	Black
B9	Light brown	■ ■ ■	Red
B10	Yellow	■ ■ ■	Black
B11	Yellow	■ ■ ■	Red
B12	Light green	■ ■ ■	Black
B13	Light green	■ ■ ■	Red
—			Shield

Weight

Product no.	Weight [g]
LEC-CN5-1	170
LEC-CN5-3	320
LEC-CN5-5	520

JXCE1/91/P1/D1/L1/M1 Series

JXC51/61 Series

Options: Actuator Cable

[Robotic cable for battery-less absolute (Step motor 24 VDC)]

LE-CE-1

Cable length (L) [m]

1	1.5
3	3
5	5
8	8*1
A	10*1
B	15*1
C	20*1

*1 Produced upon receipt of order

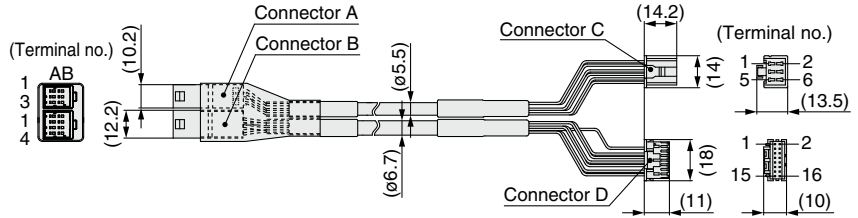

Weight

Product no.	Weight [g]	Note
LE-CE-1	190	Robotic cable
LE-CE-3	360	
LE-CE-5	570	
LE-CE-8	900	
LE-CE-A	1120	
LE-CE-B	1680	
LE-CE-C	2210	

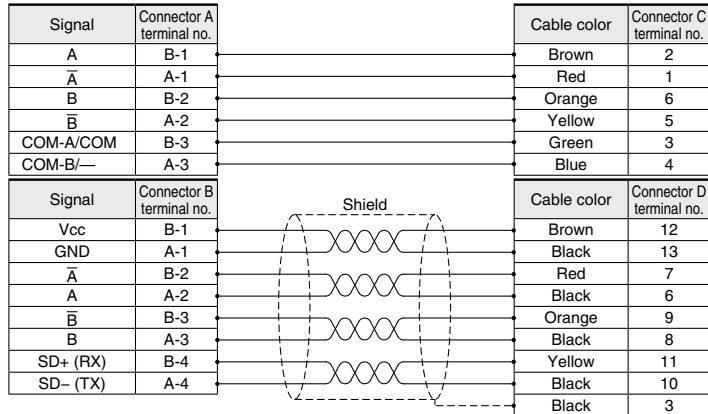

[Robotic cable with lock for battery-less absolute (Step motor 24 VDC)]

LE-CE-1-B

Cable length (L) [m]

1	1.5
3	3
5	5
8	8*1
A	10*1
B	15*1
C	20*1

*1 Produced upon receipt of order

With lock and sensor

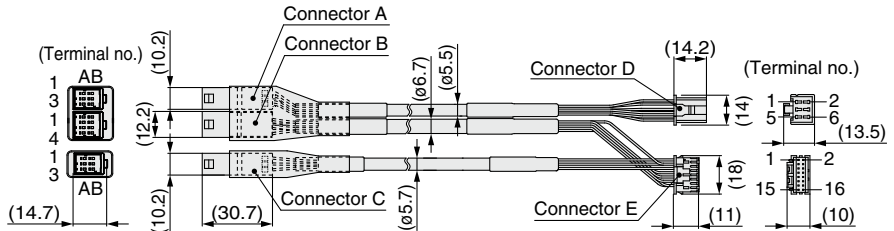

Weight

Product no.	Weight [g]	Note
LE-CE-1-B	240	Robotic cable
LE-CE-3-B	460	
LE-CE-5-B	740	
LE-CE-8-B	1170	
LE-CE-A-B	1460	
LE-CE-B-B	2120	
LE-CE-C-B	2890	

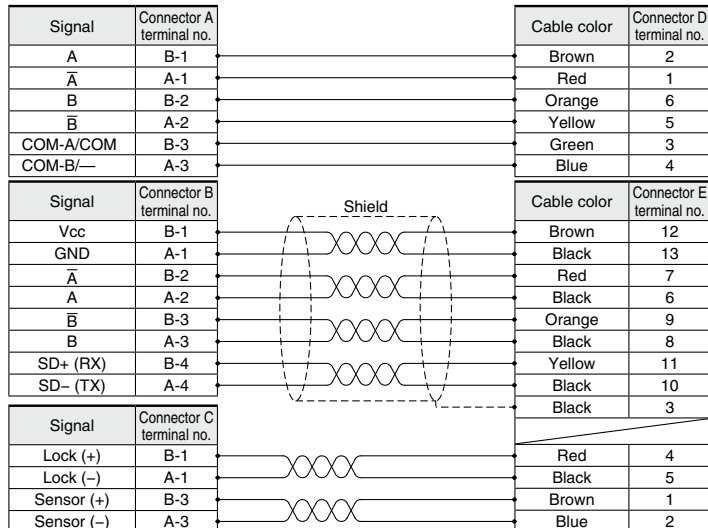



JXCE1/91/P1/D1/L1/M1/51/61 Series Precautions Relating to Differences in Controller Versions

As the controller version of the JXC series differs, the internal parameters are not compatible.

- If using the JXC□1□-BC or JXC□1□-BC-E, please use the latest version of the JXC-BCW (parameter writing tool).
- There are currently 3 versions available: version 1 products (V1.□ or S1.□), version 2 products (V2.□ or S2.□), and version 3 products (V3.□ or S3.□). Keep in mind that in order to write a backup file (.bcp) to another controller with the JXC-BCW, it needs to be the same version as the controller that created the file. (For example, a backup file created by a version 1 product can only be written to another version 1 product, and so on.) A backup file for the electric actuator with battery-less absolute encoder can only be written between version 3.4 or higher product (the backup file of version 2 or earlier products cannot be written).

Identifying Version Symbols

JXC□1 Series Version V3.□ or S3.□ Products

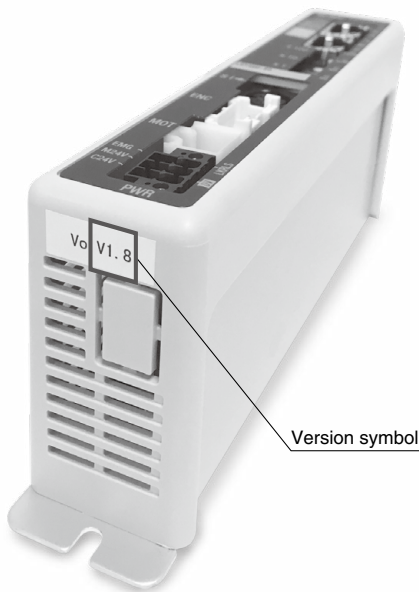

XR V3.0

Applicable models

JXC91□ Series

XR S3.0 T1.0

Applicable models

JXCD1□ Series
JXCE1□ Series
JXCP1□ Series
JXCL1□ Series
JXCM1□ Series
JXC51/61□ Series

JXC□1 Series Version V2.□ or S2.□ Products

WP V2.1

Applicable models

JXC91□ Series

WP S2.2 T1.1

Applicable models

JXCD1□ Series
JXCE1□ Series
JXCP1□ Series
JXCL1□ Series

JXC□1 Series Version V1.□ or S1.□ Products

XR V1.0

Applicable models

JXC91□ Series

XR S1.0 T1.0

Applicable models

JXCD1□ Series
JXCE1□ Series
JXCP1□ Series
JXCL1□ Series

■ Trademark

EtherNet/IP™ is a trademark of ODVA.

DeviceNet™ is a trademark of ODVA.

EtherCAT® is registered trademark and patented technology, licensed by Beckhoff Automation GmbH, Germany.

 **Safety Instructions** Be sure to read the "Handling Precautions for SMC Products" (M-E03-3) and "Operation Manual" before use.