

# Series 10-SYJ3000/5000/7000

Rubber Seal  
4/5 Port Solenoid Valve





Manifold variations	A, B port size									Manifold option		
	M3	M5	1/8	One-touch fittings						Blanking plate	Individual SUP spacer	Individual EXH spacer
				ø4	ø6	ø8	ø5/32"	ø1/4"	ø5/16"			

## Individual wiring

Common SUP/Common EXH	5 port body ported	Type 20	10-SYJ3000 P. 299	●	—	—	—	—	—	—	—	—	●	—	—
				10-SYJ5000 P. 327	—	●	—	●	●	—	●	●	—	●	—
Common SUP/Common EXH	5 port body ported	Type 21	10-SYJ7000 P. 357	—	—	●	—	●	●	—	●	●	●	—	●
				10-SYJ3000 P. 299	●	—	—	—	—	—	—	—	—	●	—
Common SUP/Common EXH	4 port base mounted	Type 31	10-SYJ3000 P. 299	—	●	—	●	—	—	●	—	—	●	—	—
				10-SYJ5000 P. 327	—	—	●	—	—	—	—	—	—	●	—
Common SUP/Common EXH	4 port base mounted	Type 32	10-SYJ3000 P. 299	—	—	●	—	—	—	—	—	—	●	—	—
				10-SYJ7000 P. 357	—	—	●	—	—	—	—	—	—	●	●
Common SUP/Common EXH	5 port base mounted	Type 40	10-SYJ5000 P. 327	—	—	●	—	—	—	—	—	—	●	—	●
				10-SYJ7000 P. 357	—	—	●	—	—	—	—	—	—	●	●
Common SUP/Common EXH	5 port base mounted	Type 41	10-SYJ3000 P. 299	—	—	●	—	—	—	—	—	—	●	—	—
				10-SYJ5000 P. 327	—	—	●	—	—	—	—	—	—	●	●
Common SUP/Common EXH	5 port base mounted	Type 42	10-SYJ7000 P. 357	—	—	●	—	—	—	—	—	—	●	●	●
				10-SYJ5000 P. 327	—	—	●	—	—	—	—	—	—	●	●
Common SUP/Common EXH	5 port base mounted	Type 43	10-SYJ5000 P. 327	—	—	—	●	—	—	—	—	—	●	●	●
				10-SYJ3000 P. 299	—	—	—	●	—	—	—	—	—	●	—
Common SUP/ Individual EXH	5 port base mounted	Type 46	10-SYJ3000 P. 299	—	—	—	●	—	—	—	—	—	●	—	—

Manifold variations	A, B port size						Manifold option		
	M3	M5	1/8	One-touch fittings			Blanking plate	Individual SUP spacer	Individual EXH spacer
				ø4	ø6	ø8			

**Flat Ribbon Cable**

5 port body ported 	<b>Type 20P</b> <b>10-SYJ5000</b> <small>P. 328</small>	—	●	—	●	●	—	●	●	—	●	—	—
5 port body ported 	<b>Type 21P</b> <b>10-SYJ3000</b> <small>P. 300</small>	●	—	—	—	—	—	—	—	—	●	—	—
	<b>10-SYJ7000</b> <small>P. 358</small>	—	—	●	—	●	●	—	●	●	●	—	—
4 port base mounted 	<b>Type 32P</b> <b>10-SYJ3000</b> <small>P. 300</small>	—	●	—	●	—	—	●	—	—	●	—	—
5 port base mounted 	<b>Type 41P</b> <b>10-SYJ5000</b> <small>P. 328</small>	—	●	—	—	—	—	—	—	—	●	—	—
5 port base mounted 	<b>Type 43P</b> <b>10-SYJ5000</b> <small>P. 328</small>	—	—	—	●	—	—	●	—	—	●	—	—

Directional Control Valves

Air Cylinders

Rotary Actuators

Air Grippers

Air Preparation Equipment

Modular F. R.

Pressure Control Equipment







Fittings & Tubing

Flow Control Equipment

Pressure Switches/ Pressure Sensors

Manifold variations	A, B port size						Manifold option		
	M3	M5	1/8	One-touch fittings			Blanking plate	Individual SUP spacer	Individual EXH spacer
				ø4	ø6	ø8			

**EX510 Gateway-type Serial Transmission System**

5 port body ported  Type <b>20SA</b>	<b>10-SYJ5000</b> P. 325	—	●	—	●	●	—	●	●	—	●	—	—
5 port body ported  Type <b>21SA</b>	<b>10-SYJ3000</b> P. 297	●	—	—	—	—	—	—	—	—	●	—	—
	<b>10-SYJ7000</b> P. 355	—	—	●	—	●	●	—	●	●	●	—	—
4 port base mounted  Type <b>32SA</b>	<b>10-SYJ3000</b> P. 298	—	●	—	●	—	—	●	—	—	●	—	—
5 port base mounted  Type <b>41SA</b>	<b>10-SYJ5000</b> P. 326	—	●	—	—	—	—	—	—	—	●	—	—
	<b>10-SYJ7000</b> P. 356	—	—	●	—	—	—	—	—	●	●	—	—
5 port base mounted  Type <b>42SA</b>	<b>10-SYJ5000</b> P. 326	—	—	●	—	—	—	—	—	—	●	—	—
5 port base mounted  Type <b>43SA</b>	<b>10-SYJ5000</b> P. 326	—	—	—	●	—	—	●	—	—	●	—	—

**Manifold option**

Individual SUP spacer assembly

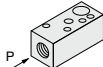

Individual EXH spacer assembly

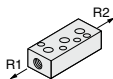





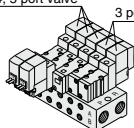





**3 port valve and 4/5 port valve mixed mounting**

4, 5 port valve      3 port valve

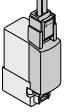

\* Refer to page 301 for further information on the 10-SYJ3000 series, page 330 on the 10-SYJ5000 series and page 360 on the 10-SYJ7000 series.

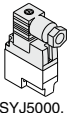
**Variations**

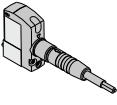
	Series	Sonic conductance: C [dm <sup>3</sup> /(s·bar)]	Actuation type	Voltage	Electrical entry	Option	Manual override		
						With light/surge voltage suppressor			
<b>Body ported</b>	<b>10-SYJ3000</b>  P. 283	Effective area 0.9 mm <sup>2</sup> { 4/2 → 5/3 } { (A/B → EA/EB) }		<b>For DC</b>  ■ 24 VDC 12 VDC 6 VDC 5 VDC 3 VDC	Grommet 	<b>For DC</b>  ■ With surge voltage suppressor			
	<b>10-SYJ5000</b>  P. 311	0.47 { 4/2 → 5/3 } { (A/B → EA/EB) }						L plug connector 	■ With light/surge voltage suppressor
	<b>10-SYJ7000</b>  P. 342	2.4 { 4/2 → 5/3 } { (A/B → EA/EB) }						2 position ● Single ● Double  M plug connector 	
<b>Base mounted</b>	<b>10-SYJ3000</b>  P. 283	0.46 { 4/2 → 5/3 } { (A/B → EA/EB) }	3 position ● Closed center ● Exhaust center ● Pressure center	<b>For AC</b>  ■ 100 VAC <sup>50/60</sup> Hz 110 VAC <sup>50/60</sup> Hz 200 VAC <sup>50/60</sup> Hz 220 VAC <sup>50/60</sup> Hz		<b>For AC</b> (Note)  ■ With light/surge voltage suppressor	■ Non-locking push type		
	<b>10-SYJ5000</b>  P. 311	0.83 { 4/2 → 5/3 } { (A/B → EA/EB) }						DIN terminal   (10-SYJ5000, 7000 only)	■ Push-turn locking slotted type
	<b>10-SYJ7000</b>  P. 342	2.9 { 4/2 → 5/3 } { (A/B → EA/EB) }						M8 connector 	■ Push-turn locking lever type

Note) All AC voltage models have built-in surge voltage suppressor.

**Directional Control Valves**

Air Cylinders

Rotary Actuators

Air Grippers

Air Preparation Equipment

Modular F. R.

Pressure Control Equipment

Fittings & Tubing

Flow Control Equipment

Pressure Switches/  
Pressure Sensors

# Series 10-SYJ3000 Rubber Seal 4/5 Port Solenoid Valve

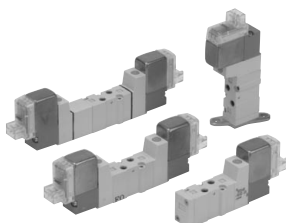

Body ported

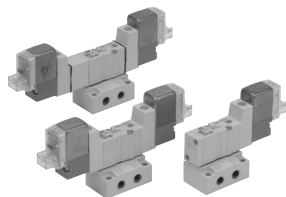

Base mounted

## Specifications

<b>Fluid</b>		Air
<b>Operating pressure range (MPa)</b>	2 position single	0.15 to 0.7
	2 position double	0.1 to 0.7
	3 position	0.2 to 0.7
<b>Ambient and fluid temperature (°C)</b>		-10 to 50 (No freezing)
<b>Response time (ms)</b> <sup>Note 1)</sup> (at 0.5 MPa)	2 position single, double	15 or less
	3 position	30 or less
	2 position single, double	10
<b>Max. operating frequency (Hz)</b>	2 position single, double	10
	3 position	3
<b>Manual override (Manual operation)</b>		Non-locking push type, Push-turn locking slotted type, Push-turn locking lever type
<b>Pilot exhaust method</b>		Main/Pilot valve common exhaust
<b>Lubrication</b>		Not required
<b>Mounting orientation</b>		Unrestricted
<b>Impact/Vibration resistance (m/s<sup>2</sup>)</b> <sup>Note 2)</sup>		150/30
<b>Enclosure</b>		Dust proof (* M8 connector conforms to IP65.)

\* Based on IEC60529

Note 1) Based on dynamic performance test, JIS B 8375-1981. (Coil temperature: 20°C, at rated voltage, without surge voltage suppressor)

Note 2) Impact resistance: No malfunction occurred when it was tested in the axial direction and at right angles to the main valve and armature in both energized and de-energized states once for each condition. (Default settings)

Vibration resistance: No malfunction occurred in a one-sweep test between 45 and 2000 Hz. Test was performed in both energized and de-energized states in the axial direction and at right angles to the main valve and armature. (Default settings)

## Symbol

### 5 port

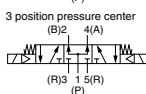
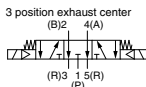
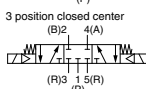
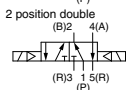
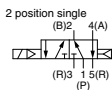

### 4 port (Manifold)

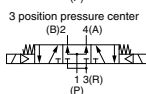
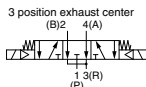
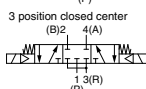
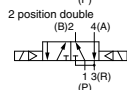
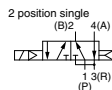

## Solenoid Specifications

<b>Electrical entry</b>		Grommet (G), (H), L plug connector (L), M plug connector (M), M8 connector (W)	
<b>Coil rated voltage (V)</b>	DC	24, 12, 6, 5, 3	
	AC <sup>50/60</sup> Hz	100, 110, 200, 220	
<b>Allowable voltage fluctuation</b>		±10% of rated voltage *	
<b>Power consumption (W)</b>	DC	Standard 0.35 (With light: 0.4)	
	With power saving circuit	0.1 (With light only) * [Starting 0.4, Holding 0.1]	
<b>Apparent power (VA) *</b>	AC	100 V	0.78 (With light: 0.81)
		110 V	0.86 (With light: 0.89)
		[115 V]	[0.94 (With light: 0.97)]
		200 V	1.18 (With light: 1.22)
		220 V [230 V]	1.30 (With light: 1.34) [1.42 (With light: 1.46)]
<b>Surge voltage suppressor</b>		Diode (Non-polarity type: Varistor)	
<b>Indicator light</b>		LED	

\* Common between 110 VAC and 115 VAC, and between 220 VAC and 230 VAC.

\* For 115 VAC and 230 VAC, the allowable voltage is -15% to +5% of rated voltage.

\* For details, refer to page 372.

## Bracket Mounting

- ① Insert the lower hook of the mounting bracket into the groove on the bottom of the valve as shown.
- ② Press the valve and mounting bracket together until the upper hook of the bracket snaps into place in the groove on top of the valve.

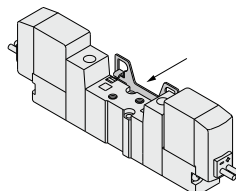
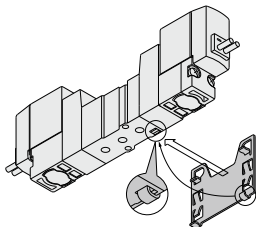

**Made to Order**  
(For details, refer to page 369.)

## Flow Rate Characteristics/Weight

Valve model	Actuation type	Port size		Weight (g) <sup>Note 3, 4)</sup>			Effective area (mm <sup>2</sup> )	Flow rate characteristics <sup>Note 2)</sup>													
		1, 5, 3 (P, EA, EB)	4, 2 (A, B)	Grommet	L/M plug connector	M8 connector		1→4/2 (P→A/B)			4/2→5/3 (A/B→EA/EB)										
		C [dm <sup>3</sup> /s-bar]	b	Cv	C [dm <sup>3</sup> /s-bar]	b		Cv													
5 port Base mounted (with sub-plate)	2 position	Single	M5 x 0.8	M5 x 0.8	62 (36)	63 (37)	67 (41)	—	0.46	0.36	0.12	0.46	0.35	0.12							
		Double			79 (53)	81 (55)	89 (63)														
	3 position	Closed center			82 (56)	84 (58)	92 (66)								—	0.47	0.33	0.12	0.47	0.31	0.12
		Exhaust center													—	0.36	0.39	0.10	0.59 [0.40]	0.43 [0.33]	0.16 [0.11]
	Pressure center	—	0.58 [0.32]	0.42 [0.33]	0.16 [0.080]	0.46	0.32	0.11													
5 port Body ported	2 position	Single	M3 x 0.5	M3 x 0.5	36	37	41	0.9	—	—	—	—	—	—							
		Double			53	55	63														
	3 position	Closed center			56	58	66								—	—	—	—	—	—	
		Exhaust center													—	—	—	—	—		
		Pressure center													—	—	—	—	—		
4 port Base mounted (For manifold base only)	2 position	Single	1/8	M5 x 0.8	36	37	41	—	—	—	—	—	—								
		Double			53	55	63														
	3 position	Closed center			56	58	66							—	—	—	—	—			
		Exhaust center												—	—	—	—	—			
		Pressure center												—	—	—	—	—			

Note 1) Dedicated for manifold base. For details, refer to page 293.  
 Note 2) [ ] denotes normal position. Exhaust center: 4/2 → 5/3, Pressure center: 1 → 4/2  
 Note 3) ( ): Without sub-plate.  
 Note 4) For DC voltages. For AC voltages, add 3 g to the weight of the single solenoid and 6 g to the weight of the double solenoid and 3 position types.

## Cylinder Speed Chart

Use as a guide for selection.  
 Please confirm the actual conditions with SMC Model Selection Software.

### Body Ported

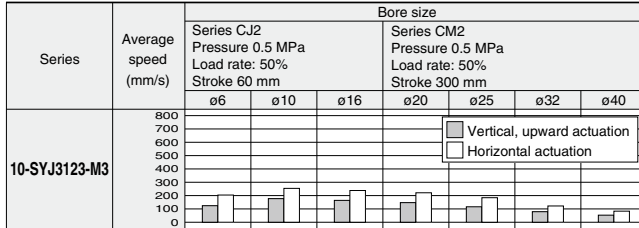

### Base Mounted

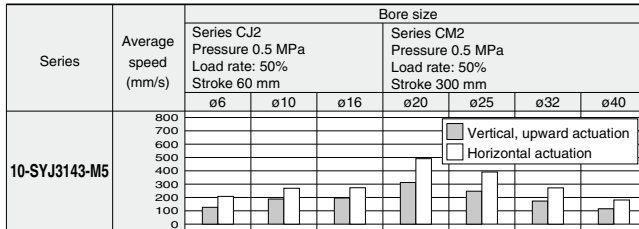

\* Cylinder is in extending. Speed controller is meter-out, which is directly connected with cylinder and its needle is fully opened.  
 \* Average speed of cylinder is obtained by dividing the full stroke time by the stroke.  
 \* Load factor: ((Load mass x 9.8)/Theoretical force) x 100%

## Conditions

Body ported			Base mounted	
Series CJ2	Series CM2	Series CJ2	Series CM2	
Tubing diameter x Length	ø4 x 1 m	Tubing diameter x Length	ø6 x 1 m	
Speed controller	AS1002F-04	Speed controller	AS2002F-06   AS2002F-06	
Silencer	AN120-M5	Silencer	AN120-M5	

Directional Control Valves  
 Air Cylinders  
 Rotary Actuators  
 Air Grippers  
 Air Preparation Equipment  
 Modular F. R.  
 Pressure Control Equipment  
 Fittings & Tubing  
 Flow Control Equipment  
 Pressure Switches/ Pressure Sensors



## How to Order

Note) CE-compliant:  
For DC only. [Option]

### Actuation type

1	2 position single solenoid
2	2 position double solenoid
3	3 position closed center
4	3 position exhaust center
5	3 position pressure center

### Light/Surge voltage suppressor

Nil	Without light/surge voltage suppressor
S	With surge voltage suppressor
Z	With light/surge voltage suppressor
R	With surge voltage suppressor (Non-polar type)
U	With light/surge voltage suppressor (Non-polar type)

\* For AC voltage valves there is no "S" option. It is already built into the rectifier circuit.  
\* For type "R" and "U", only DC voltage is available.  
\* Power saving circuit is only available for the "Z" type.

### Bracket

Nil: Without bracket  
F: With bracket

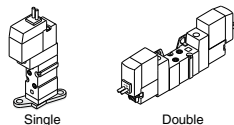

\* Brackets cannot be retrofitted.

Note) • The double solenoid mounting bracket is supplied unattached.

• To order the double solenoid bracket for use with a single solenoid valve, order the single solenoid valve without a bracket and order the bracket (VJ3000-13-1) separately.  
(Example) 10-SYJ3120-5M-M3 VJ3000-13-1

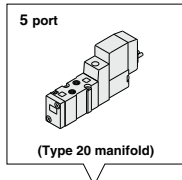

### Rated voltage

DC		CE-compliant	AC (50/60 Hz)		CE-compliant
5	24 VDC	●	1	100 VAC	—
6	12 VDC	●	2	200 VAC	—
V	6 VDC	●	3	110 VAC [115 VAC]	—
S	5 VDC	●	4	220 VAC [230 VAC]	—
R	3 VDC	●			

\* For type W□, only DC voltage is available.  
Note) CE-compliant: For DC only.

**Body ported**  
**Base mounted (4 port)**  
**Base mounted (5 port)**

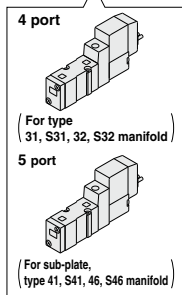
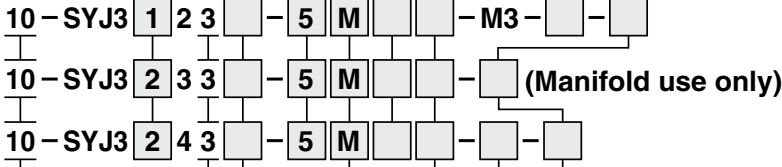

### Clean series

#### Body option

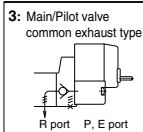

#### Coil type

Nil	Standard
T	With power saving circuit (24, 12 VDC only)

\* Power saving circuit is not available for W□ type.

### Manual override

Nil: Non-locking push type

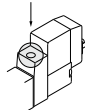

D: Push-turn locking slotted type

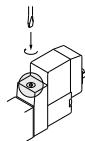

E: Push-turn locking lever type

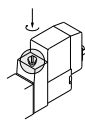

### Port size

Nil: Without sub-plate

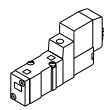

(With gasket and screws)

M5: With M5 port sub-plate

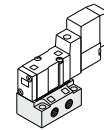

### Electrical entry

24, 12, 6, 5, 3 VDC 100, 110, 200, 220 VAC				24, 12, 6, 5, 3 VDC	
Grommet	L plug connector	M plug connector		M8 connector	
G: Lead wire length 300 mm	L: With lead wire (Length 300 mm)	M: With lead wire (Length 300 mm)	MN: Without lead wire	WO: Without connector cable	
H: Lead wire length 600 mm	LN: Without lead wire	LO: Without connector	MO: Without connector	W□: With connector cable (Note 1)	

\* LN, MN type: With 2 sockets.  
\* Refer to page 371 for the lead wire length of L and M plug connectors.  
\* Refer to page 374 for the connector assembly with cover for L and M plug connectors.  
\* For connector cable of M8 connector, refer to page 374.  
\* M8 connector conforming to IEC60947-5-2 standard is also available. Refer to page 369 for details.  
Note 1) Enter the cable length symbols in □. Please be sure to fill in the blank referring to page 374.

Note) When placing an order for body ported solenoid valves as a single unit, the mounting screws for the manifold and gasket are not attached. Order them separately, if necessary. (For details, refer to page 301.)

### CE-compliant

Nil	—
Q	CE-compliant

Note) CE-compliant: For DC only.

**Construction**

**2 position single**

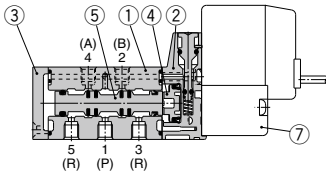
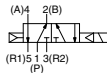

**2 position double**

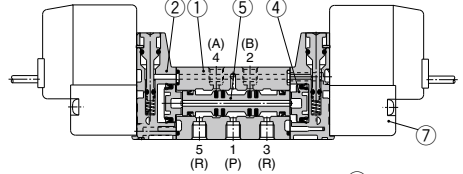
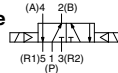

**3 position closed center/exhaust center/pressure center**

3 position closed center

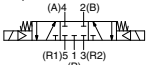

3 position exhaust center



3 position pressure center

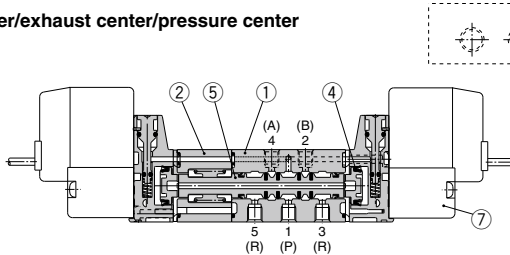
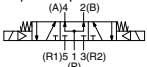

(This figure shows a closed center type.)

**Component Parts**

No.	Description	Material	Note
1	Body	Zinc die-casted	White
2	Piston plate	Resin	White
3	End cover	Resin	White
4	Piston	Resin	
5	Spool valve assembly	Aluminum, H-NBR	

**Replacement Parts**

No.	Description	Part no.	Note
6	Sub-plate <sup>(Note)</sup>	SYJ3000-22-1(-Q)	Zinc die-casted
7	Pilot valve	V111(T) □ □ □	

(Note) Add suffix "-Q" for the CE-compliant product.

**How to Order Pilot Valve Assembly**

V111 □ — 5 G □

**Coil type**

NH	Standard
T	With power saving circuit (24, 12 VDC only)

\* Power saving circuit is not available for W□ type.

**Light/Surge voltage suppressor**

NH	Without light/surge voltage suppressor
S	With surge voltage suppressor
Z	With light/surge voltage suppressor
R	With surge voltage suppressor (Non-polar type)
U	With light/surge voltage suppressor (Non-polar type)

\* For AC voltage valves there is no "S" option. It is already built into the rectifier circuit.  
 \* For type "R" and "U", only DC voltage is available.  
 \* Power saving circuit is only available for the "Z" type.

**Rated voltage**

5	24 VDC
6	12 VDC
V	6 VDC
S	5 VDC
R	3 VDC
1	100 VAC 50/60 Hz
2	200 VAC 50/60 Hz
3	110 VAC 50/60 Hz [115 VAC 50/60 Hz]
4	220 VAC 50/60 Hz [230 VAC 50/60 Hz]

\* For type W□, only DC voltage is available.  
 \* CE-compliant: For DC only.

**Electrical entry**

G	Grommet, 300 mm lead wire
H	Grommet, 600 mm lead wire
L	L plug connector
LN	With lead wire
LO	Without lead wire
M	M plug connector
MN	With lead wire
MO	Without lead wire
WO	Without connector
W□	M8 Without connector cable
W□	With connector cable <sup>(Note 1)</sup>

\* For connector cable of M8 connector, refer to page 374.  
 Note 1) Enter the cable length symbols in □. Please be sure to fill in the blank referring to page 374.

(Note) Since V111 is CE-compliant as standard, the suffix "-Q" is not necessary.

Directional Control Valves  
 Air Cylinders  
 Rotary Actuators  
 Air Grippers  
 Air Preparation Equipment  
 Modular F. R.  
 Pressure Control Equipment  
 Fittings & Tubing  
 Flow Control Equipment  
 Pressure Switches/Pressure Sensors



## 2 Position Single

\* [ ]: AC

Grommet (G), (H): 10-SYJ3123-□<sup>G</sup>□□-M3

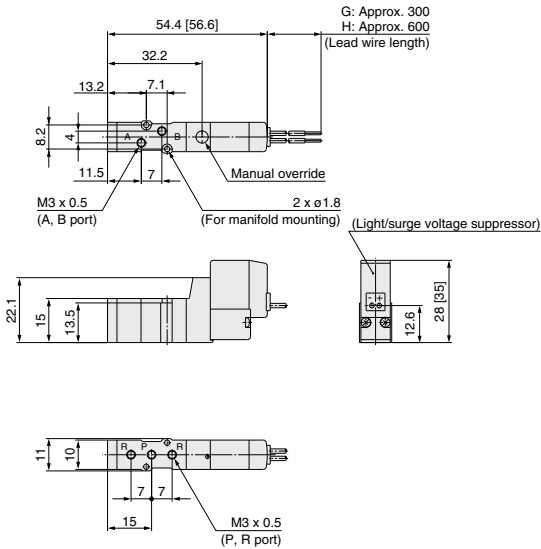

With bracket:

10-SYJ3123-□<sup>G</sup>□□-M3-F

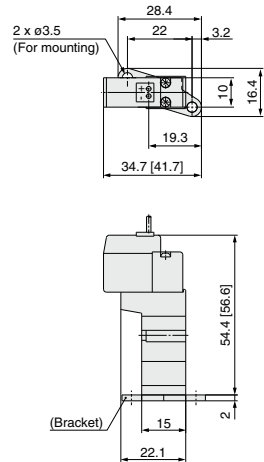

L plug connector (L):  
10-SYJ3123-□L□□-M3 (-F)

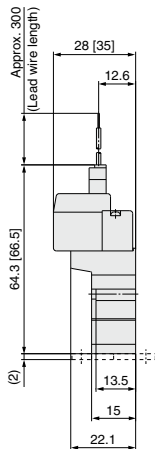

M plug connector (M):  
10-SYJ3123-□M□□-M3 (-F)

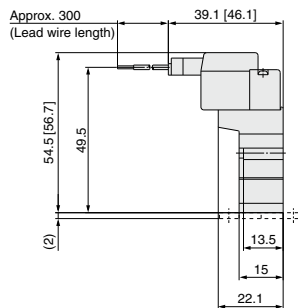

M8 connector (WO):  
10-SYJ3123-□WO□□-M3 (-F)

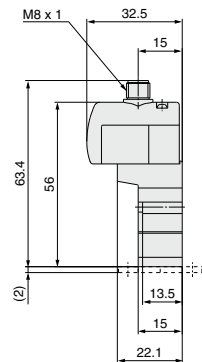

\* Refer to page 375 for dimensions with connector cable.

**2 Position Double**

\* [ ] : AC

Grommet (G), (H): 10-SYJ3223-□<sub>G</sub>□□-M3 (-F)

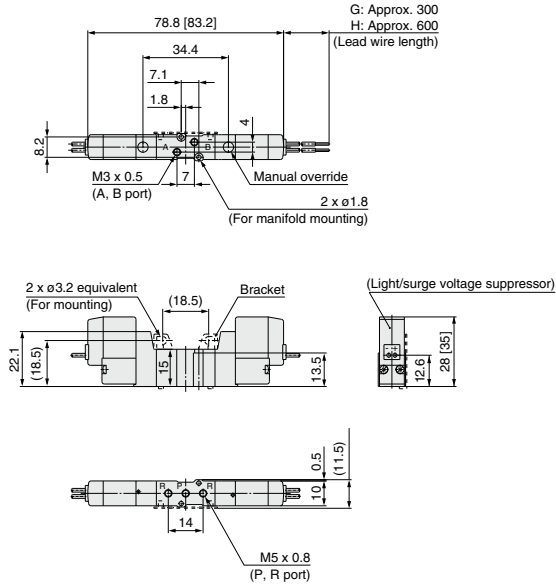

**L plug connector (L):**  
10-SYJ3223-□L□□-M3 (-F)

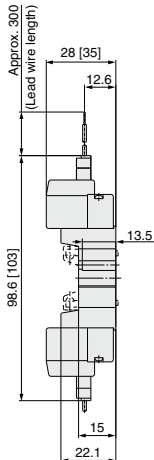

**M plug connector (M):**  
10-SYJ3223-□M□□-M3 (-F)

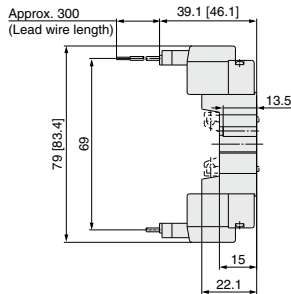

**M8 connector (WO):**  
10-SYJ3223-□WO□□-M3 (-F)

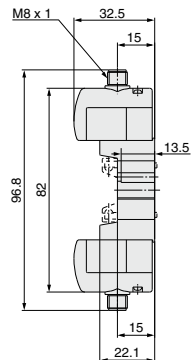

\* Refer to page 375 for dimensions with connector cable.

Directional Control Valves  
Air Cylinders  
Rotary Actuators  
Air Grippers  
Air Preparation Equipment  
Modular F. R.  
Pressure Control Equipment  
Fittings & Tubing  
Flow Control Equipment  
Pressure Switches/ Pressure Sensors

**3 Position Closed Center/Exhaust Center/Pressure Center**

\* [ ]: AC

**Grommet (G), (H): 10-SYJ3<sup>3/8</sup>23-□□□□-M3 (-F)**

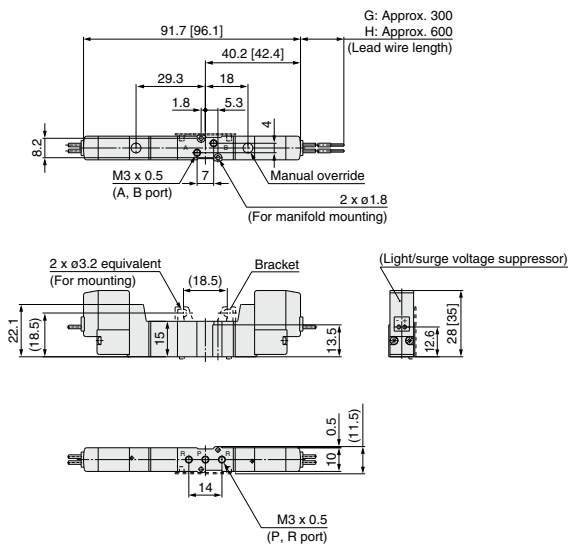

**L plug connector (L):**  
**10-SYJ3<sup>3/8</sup>23-□L□□-M3 (-F)**

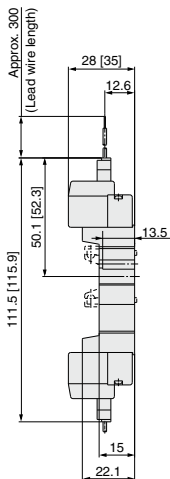

**M plug connector (M):**  
**10-SYJ3<sup>3/8</sup>23-□M□□-M3 (-F)**

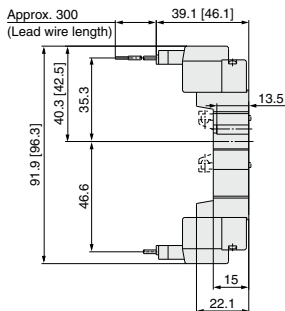

**M8 connector (WO):**  
**10-SYJ3<sup>3/8</sup>23-□WO□□-M3 (-F)**

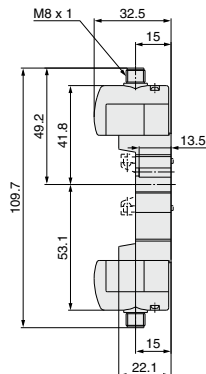

\* Refer to page 375 for dimensions with connector cable.

**2 Position Single**

\* [ ]: AC

**Grommet (G), (H): 10-SYJ3143-□□□□-M5**

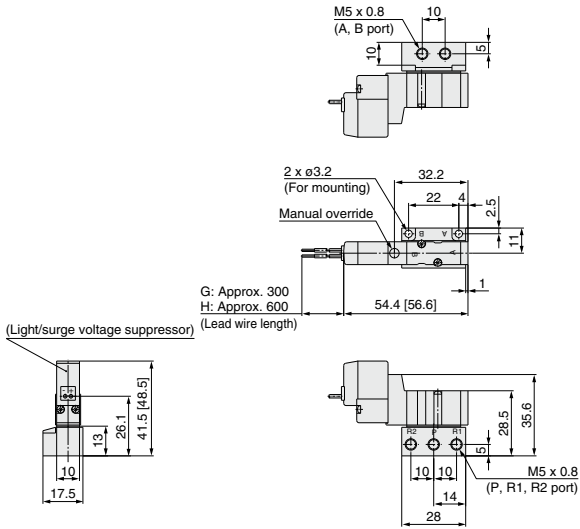

**L plug connector (L):  
10-SYJ3143-□L□□-M5**

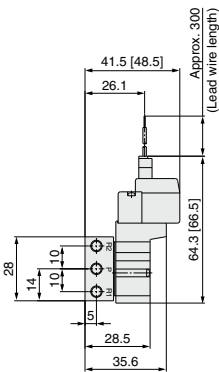

**M plug connector (M):  
10-SYJ3143-□M□□-M5**

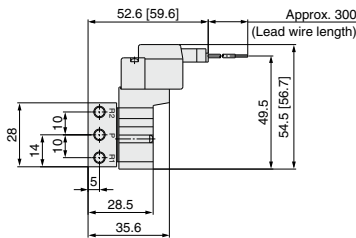

**M8 connector (WO):  
10-SYJ3143-□WO□□-M5**

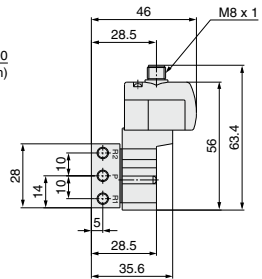

\* Refer to page 375 for dimensions with connector cable.

Directional Control Valves  
Air Cylinders  
Rotary Actuators  
Air Grippers  
Air Preparation Equipment  
Modular F. R.  
Pressure Control Equipment  
Fittings & Tubing  
Flow Control Equipment  
Pressure Switches/  
Pressure Sensors





## Standard Manifold

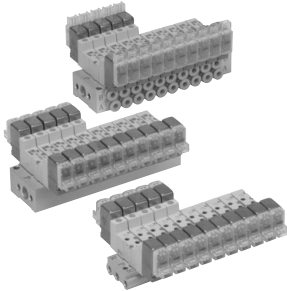

### Manifold Specifications

Model		Type 20	Type 31, S31	Type 32, S32	Type 41, S41	Type 46, S46
<b>Manifold type</b>		Single base/B mount				
<b>P (SUP), R (EXH)</b>		Common SUP/Common EXH				Common SUP Individual EXH
<b>Valve stations</b>		2 to 20 stations				
<b>A, B port Porting specifications</b>	<b>Location</b>	Valve	Base			
	<b>Direction</b>	Top	Side			
<b>Port size</b>	<b>P, R port</b>	M5 x 0.8		1/8		P: 1/8 R: M5 x 0.8
	<b>A, B port</b>	M3 x 0.5		M5 x 0.8, C4 (ø4 One-touch fitting)		

### Flow Rate Characteristics

Manifold			Port size		Flow rate characteristics						Effective area (mm <sup>2</sup> )
					1 → 4/2 (P → A/B)			4/2 → 5/3 (A/B → R)			
					C [dm <sup>3</sup> /(s·bar)]	b	Cv	C [dm <sup>3</sup> /(s·bar)]	b	Cv	
Body ported for internal pilot	Type 10-SS5YJ3-20	10-SYJ3□23	M5 x 0.8	M3 x 0.5	—	—	—	—	—	—	0.9
	Type 10-SS5YJ3-31 S31	10-SYJ3□33	M5 x 0.8	M3 x 0.5	—	—	—	—	—	—	0.9
Base mounted for internal pilot	Type 10-SS5YJ3-32-M5	10-SYJ3□33	1/8	M5 x 0.8	0.25	0.19	0.060	0.32	0.25	0.077	—
	Type 10-SS5YJ3-32-C4			C4	0.25	0.18	0.059	0.30	0.27	0.075	—
	Type 10-SS5YJ3-S32-M5			M5 x 0.8	0.25	0.26	0.060	0.29	0.15	0.062	—
	Type 10-SS5YJ3-S32-C4	C4	0.24	0.21	0.057	0.27	0.18	0.062	—		
	Type 10-SS5YJ3-41-M5	10-SYJ3□43	1/8	M5 x 0.8	0.32	0.25	0.081	0.33	0.19	0.079	—
	Type 10-SS5YJ3-41-C4			C4	0.32	0.28	0.079	0.35	0.24	0.084	—
	Type 10-SS5YJ3-S41-M5			M5 x 0.8	0.33	0.29	0.082	0.34	0.17	0.081	—
	Type 10-SS5YJ3-S41-C4	C4	0.32	0.27	0.079	0.34	0.24	0.084	—		
	Type 10-SS5YJ3-46-M5	10-SYJ3□43	1/8	M5 x 0.8	0.20	0.25	0.048	0.10	0.12	0.024	—
	Type 10-SS5YJ3-46-C4			C4	0.21	0.27	0.050	0.21	0.13	0.047	—
	Type 10-SS5YJ3-S46-M5			M5 x 0.8	0.20	0.25	0.048	0.19	0.16	0.024	—
	Type 10-SS5YJ3-S46-C4	C4	0.22	0.34	0.057	0.10	0.090	0.024	—		

Note) The values are for individually operated 2 position type manifold bases.

### How to Order Manifold (Example)

Instruct by specifying the valves and blanking plate assembly to be mounted on the manifold along with the manifold base model no.

Example:

- 10-SS5YJ3-20-03 ..... 1 set (Manifold base)
- 10-SS5YJ3-S41-03-C4 ... 1 set (Manifold base)
- \* 10-SYJ3123-5G-M3 ... 2 sets (Valve)
- \* 10-SYJ3143-5LZ ..... 2 sets (Valve)
- \* SYJ3000-21-12A ..... 1 set (Blanking plate assembly)
- \* SYJ3000-21-12A ..... 1 set (Blanking plate assembly)

The asterisk denotes the symbol for assembly. Prefix it to the part no. of the solenoid valve, etc.

\* Use manifold specification sheet.



Note) CE-compliant:  
For DC only. [Option]

## Flat Ribbon Cable Manifold

- Multiple valve wiring is simplified through the use of the flat ribbon cable connector.
- Clean appearance

For flat ribbon cables, each valve is wired on the print board of the manifold base to allow the external wiring to be piped all together with the 26 pin MIL connector.

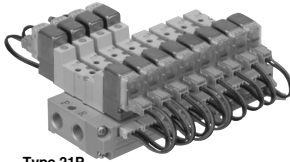

Type 21P

## Flat Ribbon Cable Manifold Specifications

Model		Type 21P	Type 32P
Manifold type		Single base/B mount	
P (SUP), R (EXH)		Common SUP, Common EXH	
Valve stations		4 to 12 stations	
A, B port Porting specifications	Location	Valve	Base
	Direction	Top	Side
Port size	P, R port	1/8	
	A, B port	M3 x 0.5	M5 x 0.8, C4 (Ø4 One-touch fitting)
Applicable flat ribbon cable connector		Socket: 26 pin MIL type with strain relief (Conforming to MIL-C-83503)	
Internal wiring		Common between +COM and -COM (Z type: +COM only)	
Rated voltage <small>Note 2)</small>		24, 12 VDC/100, 110 VAC	

Note 1) The withstand voltage specifications for the wiring unit section conforms to JIS C 0704, Grade 1 or its equivalent.  
Note 2) CE-compliant: For DC only.

## Flow Rate Characteristics

Manifold			Port size		Flow rate characteristics						Effective area (mm <sup>2</sup> )
					1 → 4/2 (P → A/B)			4/2 → 5/3 (A/B → R)			
			1(P), 5/3(R) port	2(B), 4(A) port	C (dm <sup>3</sup> /(s·bar))	b	Cv	C (dm <sup>3</sup> /(s·bar))	b	Cv	
Body ported for internal pilot	Type 10-SS5YJ3-21P	10-SYJ3-23	1/8	M3 x 0.5	-	-	-	-	-	-	0.9
Base mounted for internal pilot	Type 10-SS5YJ3-32P-M5	10-SYJ3-33	1/8	M5 x 0.8	0.25	0.19	0.060	0.32	0.25	0.077	-
	Type 10-SS5YJ3-32P-C4			C4	0.25	0.18	0.059	0.3	0.27	0.075	-

Note) The values are for individually operated 2 position type manifold bases.

## How to Order Manifold

- 10-SS5YJ3-32P-07-C4 (-Q) ..... 1 pc. (Manifold base) \* SYJ3000-21-13A (-Q) ..... 1 pc. (Blanking plate assembly)
- \* 10-SYJ3133-5LOU (-Q) ..... 3 pcs. (Valve) \* SY3000-37-28A ..... 3 pcs. (Connector assembly)
- \* 10-SYJ3233-5LOU (-Q) ..... 3 pcs. (Valve) \* SY3000-37-29A ..... 3 pcs. (Connector assembly)

↳ The asterisk denotes the symbol for assembly. Prefix it to the part no. of the solenoid valve, etc.

Note) Please indicate the connector assembly part no. below that connects the valve and the manifold.

## How to Order Valve

Note) CE-compliant: [Option]  
For DC only.

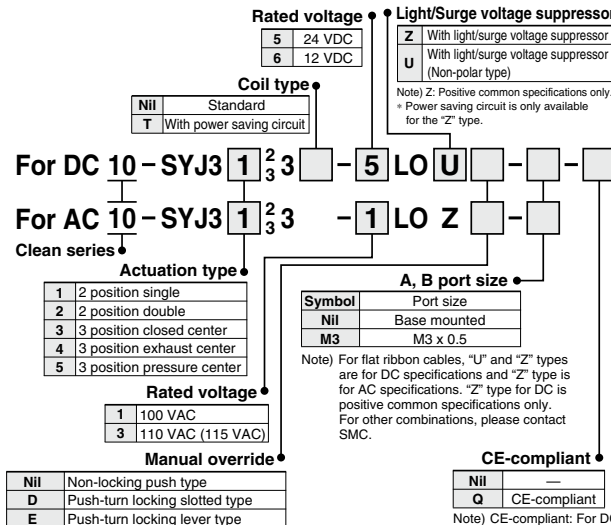

## Connector Assembly

### For 12, 24 VDC

Single solenoid	SY3000-37-28A
Double solenoid, 3 position type	SY3000-37-29A

### For 100 VAC

Single solenoid	SY3000-37-46A
Double solenoid, 3 position type	SY3000-37-47A

### For 110 VAC (115 VAC)

Single solenoid	SY3000-37-54A
Double solenoid, 3 position type	SY3000-37-55A

Directional Control Valves

Air Cylinders

Rotary Actuators

Air Grippers

Air Preparation Equipment

Modular F. R.

Pressure Control Equipment

Fittings & Tubing

Flow Control Equipment

Pressure Switches/Pressure Sensors



## EX510 Gateway-type Serial Transmission System

### Manifold for EX510 Serial Wiring Specifications

Model		Type 21SA	Type 32SA
Manifold type		Single base/B mount	
P (SUP), R (EXH)		Common SUP, Common EXH	
Valve stations		4 to 16 stations	
A, B port Porting specifications	Location	Valve	Base
	Direction	Top	Side
Port size	P, R port	1/8	
	A, B port	M3 x 0.5	M5 x 0.8, C4 (Ø4 One-touch fitting)
Rated voltage		24 VDC	

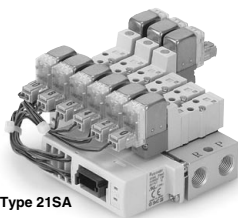

Type 21SA

### Flow Rate Characteristics

Manifold			Port size 1(P), 5/3(R) 2(B), 4(A) port	Flow rate characteristics						Effective area (mm <sup>2</sup> )	
				1 → 4/2 (P → A/B)			4/2 → 5/3 (A/B → R)				
				C (dm <sup>3</sup> /s-bar)	b	Cv	C (dm <sup>3</sup> /s-bar)	b	Cv		
Body ported for internal pilot	Type 10-SS5YJ3-21SA	10-SYJ3□23	1/8	M3 x 0.5	—	—	—	—	—	—	0.9
Base mounted for internal pilot	Type 10-SS5YJ3-32SA-M5	10-SYJ3□33	1/8	M5 x 0.8	0.25	0.19	0.060	0.32	0.25	0.077	—
	Type 10-SS5YJ3-32SA-C4			C4	0.25	0.18	0.059	0.3	0.27	0.075	—

Note) The values are for individually operated 2 position type manifold bases.

### How to Order Manifold

10-SS5YJ3-21SA-06..... 1 set (Type 21SA, 6-station manifold part no.)

\* 10-SYJ3123-5LOU-M3..... 4 sets (Single solenoid part no.)

\* 10-SYJ3223-5LOU-M3..... 2 sets (Double solenoid part no.)

↳ The asterisk denotes the symbol for assembly. Prefix it to the part no. of the solenoid valve, etc.

Add the valve and option part number under the manifold base part number.

When entry of part numbers becomes complicated, indicate by the manifold specification sheet. For a EX510 manifold, the length of the lead wire for a connector assembly depends on the number of stations. Therefore, the manifold assembly is shipped with the valves (including blanking plates) and connector assembly mounted on it, as the standard specification. Be sure to specify the part no. of the solenoid valves to be mounted.

Pressure Switches/  
Pressure Sensors

Flow Control  
Equipment

Fittings & Tubing

Pressure Control  
Equipment

Modular F. R.

Air Preparation  
Equipment

Air Grippers

Rotary Actuators

Air Cylinders

Directional  
Control Valves

### How to Order Manifold

**10-SS5YJ3-21SA** [ ] - **04** - [ ] - [ ]

- Clean series**
- SI unit**

Nil	NPN output (+ COM.)
N	PNP output (- COM.)
- CE-compliant**

Nil	—
Q	CE-compliant
- Valve stations**

Symbol	Stations	Note
04	4 stations	Double wiring <sup>Note 1)</sup>
:	:	
08	8 stations	Specified layout <sup>Note 2)</sup> (Up to 16 solenoids)
04	4 stations	
:	:	
16	16 stations	
- P, R port thread type**

Nil	Rc
00F	G
00N	NPT
00T	NPTF
- SI unit part no.**

Symbol	SI unit specifications	SI unit part no.	Page
Nil	NPN output (+ COM.)	EX510-S001	WEB catalog
N	PNP output (- COM.)	EX510-S101	

<sup>Note 1)</sup> Includes the number of the blanking plate assemblies.  
<sup>Note 1)</sup> Double wiring: Use of a single solenoid will result in an unused control signal. If this is not desired, order with a specified layout.  
<sup>Note 2)</sup> Specified layout: Indicate wiring specifications on the manifold specification sheet. (Note that double and 3 position valves cannot be used where single solenoid wiring has been specified.)

### How to Order Valve

**10-SYJ3** [ ] **23** [ ] - **5LO** [ ] - **M3** - [ ]

- Clean series**
- Coil type**

Nil	Standard
T	With power saving circuit
- Rated voltage: 24 VDC**
- Light/Surge voltage suppressor**

Z	With light/surge voltage suppressor
U	With light/surge voltage suppressor (Non-polar type)

\* Power saving circuit is only available for the "Z" type.
- Manual override**

Nil	Non-locking push type
D	Push-turn locking slotted type
E	Push-turn locking lever type
- Actuation type**

1	2 position single
2	2 position double
3	3 position closed center
4	3 position exhaust center
5	3 position pressure center
- A, B port size**
- CE-compliant**

Nil	—
Q	CE-compliant

### How to Order Manifold Assembly (Example)

**Example**

**10-SS5YJ3-21SA-06 (-Q).....1 set (Type 21SA, 6-station manifold part no.)**  
**\*10-SYJ3123-5LOU-M3 (-Q)....4 sets (Single solenoid part no.)**  
**\*10-SYJ3223-5LOU-M3 (-Q)....2 sets (Double solenoid part no.)**

The asterisk denotes the symbol for assembly. Prefix it to the part no. of the solenoid valve, etc.

Add the valve and option part number under the manifold base part number. When entry of part numbers becomes complicated, indicate by the manifold specification sheet. For a EX510 manifold, the length of the lead wire for a connector assembly depends on the number of stations. Therefore, the manifold assembly is shipped with the valves (including blanking plates) and connector assembly mounted on it, as the standard specification. Be sure to specify the part no. of the solenoid valves to be mounted.

# Series 10-SYJ3000

EX510 Gateway-type Serial Transmission System  
Base Mounted Manifold



## How to Order Manifold

**10-SS5YJ3-32SA** [ ] - **04** - **M5** [ ] - [ ]

- Clean series**
- SI unit**

Nil	NPN output (+ COM.)
N	PNP output (- COM.)
- Valve stations**

Symbol	Stations	Note
04	4 stations	Double wiring <i>Note 1)</i>
:	:	
08	8 stations	Specified layout <i>Note 2)</i> (Up to 16 solenoids)
04	4 stations	
:	:	
16	16 stations	
- P, R port thread type**

Nil	Rc
F	G
N	NPT
T	NPTF
- CE-compliant**

Nil	—
Q	CE-compliant
- A, B port size**

M5	M5 x 0.8
C4	ø4 One-touch fitting
N3	ø5/32" One-touch fitting
- SI unit part no.**

Symbol	SI unit specifications	SI unit part no.	Page
Nil	NPN output (+ COM.)	EX510-S001	<b>WEB</b>
N	PNP output (- COM.)	EX510-S101	<b>catalog</b>

*Note 1) Double wiring: Use of a single solenoid will result in an unused control signal. If this is not desired, order with a specified layout.*  
*Note 2) Specified layout: Indicate wiring specifications on the manifold specification sheet. (Note that double and 3 position valves cannot be used where single solenoid wiring has been specified.)*

Refer to the **WEB catalog** and the Operation Manual for the details of the EX510 Gateway-type Serial Transmission System. Please download the Operation Manual via our website, <http://www.smcworld.com>

## How to Order Valve

**10-SYJ3** [ ] **1** **33** [ ] - **5LO** **Z** [ ] - [ ]

- Clean series**
- Coil type**

Nil	Standard
T	With power saving circuit
- Rated voltage: 24 VDC**
- Light/Surge voltage suppressor**

Z	With light/surge voltage suppressor
U	With light/surge voltage suppressor (Non-polar type)

\* Power saving circuit is only available for the "Z" type.
- Manual override**

Nil	Non-locking push type
D	Push-turn locking slotted type
E	Push-turn locking lever type
- Actuation type**

1	2 position single
2	2 position double
3	3 position closed center
4	3 position exhaust center
5	3 position pressure center
- CE-compliant**

Nil	—
Q	CE-compliant

## How to Order Manifold Assembly (Example)

**Example**

10-SS5YJ3-32SA-06-M5 (-Q).....1 set (Type 32SA, 6-station manifold part no.)  
 \* 10-SYJ1333-5LOU (-Q).....4 sets (Single solenoid part no.)  
 \* 10-SYJ3233-5LOU (-Q).....2 sets (Double solenoid part no.)

The asterisk denotes the symbol for assembly. Prefix it to the part no. of the solenoid valve, etc.

Add the valve and option part number under the manifold base part number. When entry of part numbers becomes complicated, indicate by the manifold specification sheet. For a EX510 manifold, the length of the lead wire for a connector assembly depends on the number of stations. Therefore, the manifold assembly is shipped with the valves (including blanking plates) and connector assembly mounted on it, as the standard specification. Be sure to specify the part no. of the solenoid valves to be mounted.

Directional Control Valves  
 Air Cylinders  
 Rotary Actuators  
 Air Grippers  
 Air Preparation Equipment  
 Modular F. R.  
 Pressure Control Equipment  
 Fittings & Tubing  
 Flow Control Equipment  
 Pressure Switches/Pressure Sensors



Note) CE-compliant:  
For DC only.

[Option]

**Individual Wiring**

**Common SUP/Common EXH**

Note) For more than 10 stations, supply pressure to P port on both sides and exhaust from R port on both sides. Except type 41.

**Type 20 (5 port/Body ported)**

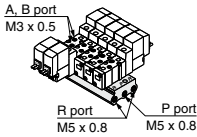

**How to Order**

**10-SS5YJ3-20-05-** [ ]

Clean series

Number of stations

02	2 stations
:	:
20	20 stations

CE-compliant

Nil	—
Q	CE-compliant

Applicable solenoid valve  
10-SYJ3□23-□□□□-M3(-Q)

Applicable blanking plate assembly  
Refer to page 302.

**Type 31 (4 port/Base mounted)**

Type 31 Type S31 (Single solenoid pilot valve is on same side as the A, B port.)

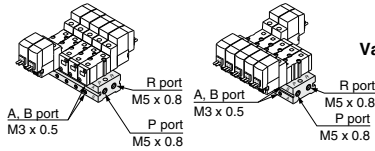

**How to Order**

**10-SS5YJ3-** [ ] **31-05-** [ ] **M3-** [ ]

Clean series

Valve mounting direction

Nil	Single solenoid pilot valve is on opposite side as the A, B port.
S	Single solenoid pilot valve is on same side as the A, B port.

Stations

02	2 stations
:	:
20	20 stations

CE-compliant

Nil	—
Q	CE-compliant

Applicable solenoid valve  
10-SYJ3□33-□□□□(-Q)

Applicable blanking plate assembly  
Refer to page 302.

**Type 32 (4 port/Base mounted)**

Type 32 Type S32 (Single solenoid pilot valve is on same side as the A, B port.)

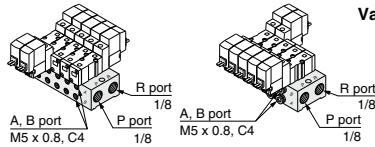

**How to Order**

**10-SS5YJ3-** [ ] **32-05-** [ ] **M5-** [ ] [ ]

Clean series

Valve mounting direction

Nil	Single solenoid pilot valve is on opposite side as the A, B port.
S	Single solenoid pilot valve is on same side as the A, B port.

Stations

02	2 stations
:	:
20	20 stations

A, B port size

M5	M5 x 0.8
C4	ø4 One-touch fitting
N3	ø5/32" One-touch fitting

CE-compliant

Nil	—
Q	CE-compliant

P, R port thread type

Nil	Rc
F	G
N	NPT
T	NPTF

**Type 41 (5 port/Base mounted)**

Type 41 Type S41 (Single solenoid pilot valve is on same side as the A, B port.)

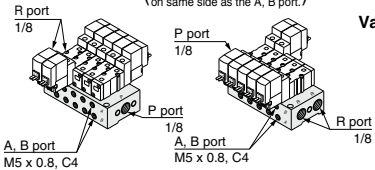

**How to Order**

**10-SS5YJ3-** [ ] **41-05-** [ ] **C4-** [ ] [ ]

Clean series

Valve mounting direction

Nil	Single solenoid pilot valve is on opposite side as the A, B port.
S	Single solenoid pilot valve is on same side as the A, B port.

Stations

02	2 stations
:	:
20	20 stations

A, B port size

M5	M5 x 0.8
C4	ø4 One-touch fitting
N3	ø5/32" One-touch fitting

CE-compliant

Nil	—
Q	CE-compliant

P, R port thread type

Nil	Rc
F	G
N	NPT
T	NPTF

Applicable solenoid valve  
10-SYJ3□43-□□□□(-Q)

Applicable blanking plate assembly  
Refer to page 302.

**Common SUP/Individual EXH**

Note) For more than 10 stations, supply pressure to P port on both sides.

**Type 46 (5 port/Base mounted)**

Type 46 Type S46 (Single solenoid pilot valve is on same side as the A, B port.)

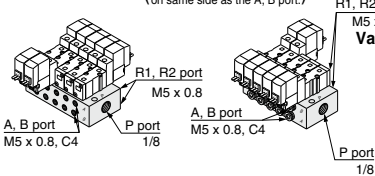

**How to Order**

**10-SS5YJ3-** [ ] **46-05-** [ ] **M5-** [ ] [ ]

Clean series

Valve mounting direction

Nil	Single solenoid pilot valve is on opposite side as the A, B port.
S	Single solenoid pilot valve is on same side as the A, B port.

Stations

02	2 stations
:	:
20	20 stations

A, B port size

M5	M5 x 0.8
C4	ø4 One-touch fitting
N3	ø5/32" One-touch fitting

CE-compliant

Nil	—
Q	CE-compliant

P port thread type

Nil	Rc
F	G
N	NPT
T	NPTF

Applicable solenoid valve  
10-SYJ3□43-□□□□(-Q)

Applicable blanking plate assembly  
Refer to page 302.



Note) CE-compliant:  
For DC only. [Option]

## Flat Ribbon Cable Manifold

### Common SUP/Common EXH

Note) For more than 10 stations, supply pressure to P port on both sides and exhaust from R port on both sides. Except type 41.

#### Type 21P (5 port/Body ported)

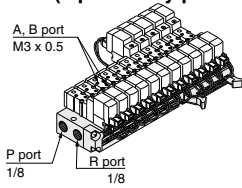

#### How to Order

**10-SS5YJ3-21P-07** - [ ] - [ ]

Clean series

Stations

04	4 stations
:	:
12	12 stations

P, R port thread type

Nil	Rc
00F	G
00N	NPT
00T	NPTF

CE-compliant

Nil	—
Q	CE-compliant

**Applicable solenoid valve**  
Refer to page 294.

**Applicable connector assembly**  
Refer to page 294.

**Applicable blanking plate assembly**  
Refer to page 302.

#### Type 32P (4 port/Base mounted)

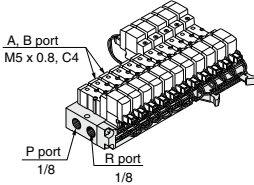

#### How to Order

**10-SS5YJ3-32P-07** - **C4** - [ ] - [ ]

Clean series

Stations

04	4 stations
:	:
12	12 stations

A, B port size

M5	M5 x 0.8
C4	ø4 One-touch fitting
N3	ø5/32" One-touch fitting

P, R port thread type

Nil	Rc
F	G
N	NPT
T	NPTF

CE-compliant

Nil	—
Q	CE-compliant

**Applicable solenoid valve**  
Refer to page 294.

**Applicable connector assembly**  
Refer to page 294.

**Applicable blanking plate assembly**  
Refer to page 302.

## EX510 Gateway-type Serial Transmission System

#### Type 21SA (5 port/Body ported)

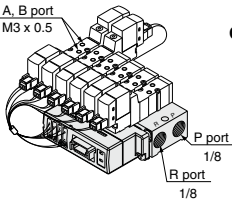

#### How to Order

**10-SS5YJ3-21SA** - [ ] - **04** - [ ] - [ ]

Clean series

SI unit

Nil	NPN output (+ COM.)
N	PNP output (- COM.)

Valve stations

Symbol	Stations	Note
04	4 stations	Double wiring <sup>Note 1)</sup>
:	:	
08	8 stations	Specified layout <sup>Note 2)</sup> (Up to 16 solenoids)
04	4 stations	
:	:	
16	16 stations	

P, R port thread type

Nil	Rc
00F	G
00N	NPT
00T	NPTF

CE-compliant

Nil	—
Q	CE-compliant

- Includes the number of the blanking plate assemblies.  
Note 1) Double wiring: Use of a single solenoid will result in an unused control signal. If this is not desired, order with a specified layout.  
Note 2) Specified layout: Indicate wiring specifications on the manifold specification sheet. (Note that double and 3 position valves cannot be used where single solenoid wiring has been specified.)

**Applicable solenoid valve**  
Refer to page 297.

**Applicable blanking plate assembly**  
Refer to page 302.

#### Type 32SA (4 port/Base mounted)

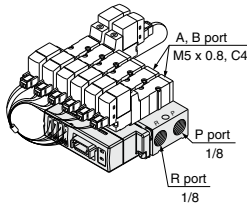

#### How to Order

**10-SS5YJ3-32SA** - [ ] - **04** - **M5** - [ ] - [ ]

Clean series

SI unit

Nil	NPN output (+ COM.)
N	PNP output (- COM.)

Valve stations

Symbol	Stations	Note
04	4 stations	Double wiring <sup>Note 1)</sup>
:	:	
08	8 stations	Specified layout <sup>Note 2)</sup> (Up to 16 solenoids)
04	4 stations	
:	:	
16	16 stations	

P, R port thread type

Nil	Rc
F	G
N	NPT
T	NPTF

CE-compliant

Nil	—
Q	CE-compliant

- Includes the number of the blanking plate assemblies.  
Note 1) Double wiring: Use of a single solenoid will result in an unused control signal. If this is not desired, order with a specified layout.  
Note 2) Specified layout: Indicate wiring specifications on the manifold specification sheet. (Note that double and 3 position valves cannot be used where single solenoid wiring has been specified.)

**Applicable solenoid valve**  
Refer to page 298.

**Applicable blanking plate assembly**  
Refer to page 302.

Directional Control Valves  
Air Cylinders  
Rotary Actuators  
Air Grippers  
Air Preparation Equipment  
Modular F. R.  
Pressure Control Equipment  
Fittings & Tubing  
Flow Control Equipment  
Pressure Switches/ Pressure Sensors

### Mixed Installation of the 10-SYJ300 and the 10-SYJ3000 Valves on the Same Manifold

The 10-SYJ300 series valves can be mounted on the 10-SYJ3000 series manifolds.

① **10-SS5YJ3-20, 10-SS5YJ3-21P, 10-SS5YJ3-21SA**  
The 3 port valve can be used by simply sealing off the unused "R" port with the rubber plug SYJ3000-33-1.

Applicable solenoid valves:  
10-SYJ312M, 10-SYJ322M

② **10-SS5YJ3-31, -S31, 10-SS5YJ3-32, -S32, 10-SS5YJ3-32SA, 10-SS5YJ3-46, -S46, 10-SS5YJ3-32P**

The 3 port valve can be used without modification. The A port of the valve will flow out of the B port of the manifold.

Applicable solenoid valves:  
10-SYJ314M, 10-SYJ324M

③ **10-SS5YJ3-41, -S41**

The 3 port valve can be used on the 4 port manifold by simply sealing off the unused "R" port with the rubber plug SYJ3000-33-1. The A port of the valve will flow out of the B port of the manifold.

Applicable solenoid valves:  
10-SYJ314M, 10-SYJ324M

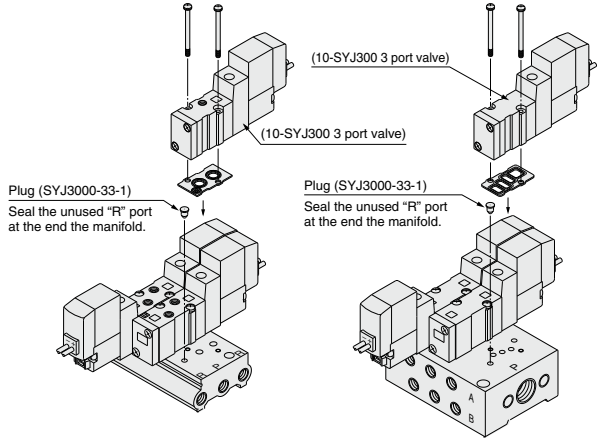

Type 10-SS5YJ3-20

Type 10-SS5YJ3-41

A port of the 3 port valve flows out of the manifold B port.

### ⚠ Caution

Mounting screw tightening torque

M1.7: 0.12 N·m

Use caution to the assembly orientation for solenoid valves, gasket, and optional parts.

### Combinations of Solenoid Valve, Manifold Gasket and Manifold Base

**5 port body ported**  
(Type 10-SYJ3□23(-Q))

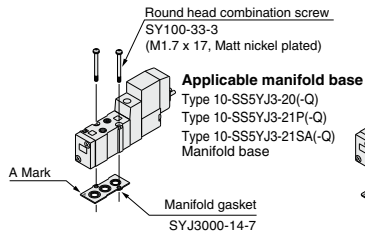

**4 port base mounted**  
(Type 10-SYJ3□33(-Q))

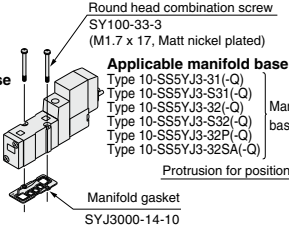

**5 port base mounted**  
(Type 10-SYJ3□43(-Q))

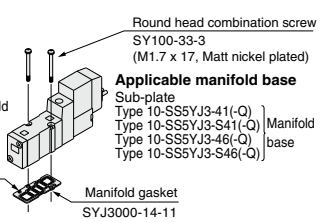

Note) Make sure to align the manifold gasket with the groove of the valve body.

### Difference between 10-SYJ3□33 and 10-SYJ3□43

**10-SYJ3□33**  
(4 port)

**10-SYJ3□43**  
(5 port)

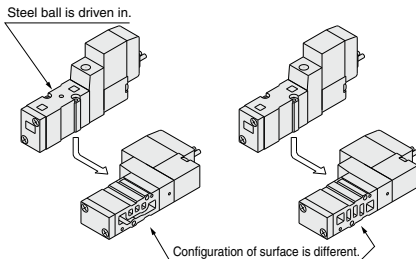

## Combination of Blanking Plate Assembly and Manifold Base

### Blanking plate assembly SYJ3000-21-12A(-Q)

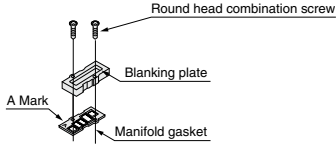

#### Applicable manifold base

- Type 10-SS5YJ3-20(-Q)
- Type 10-SS5YJ3-21SA(-Q)
- Type 10-SS5YJ3-41(-Q)
- Type 10-SS5YJ3-S41(-Q)
- Type 10-SS5YJ3-46(-Q)
- Type 10-SS5YJ3-S46(-Q)
- Type 10-SS5YJ3-31(-Q)
- Type 10-SS5YJ3-S31(-Q)
- Type 10-SS5YJ3-32(-Q)
- Type 10-SS5YJ3-S32(-Q)
- Type 10-SS5YJ3-32SA(-Q)

Manifold base

Note) Manifold gasket "SYJ3000-14-2" can be used with the following manifold bases.

- Manifold base of
- Type 10-SS5YJ3-31(-Q)
  - S31(-Q)
  - 32(-Q)
  - S32(-Q)
  - 32SA(-Q)

### Blanking plate assembly SYJ3000-21-13A(-Q)

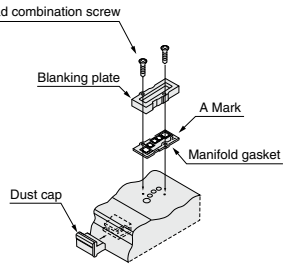

#### Applicable manifold base

- 10-SS5YJ3-21P(-Q)
- 10-SS5YJ3-32P(-Q)

Manifold base

### **Caution**

**Mounting screw tightening torque**

**M1.7: 0.12 N·m**

**Use caution to the assembly orientation for solenoid valves, gasket, and optional parts.**

Directional Control Valves

Air Cylinders

Rotary Actuators

Air Grippers

Air Preparation Equipment

Modular F. R.

Pressure Control Equipment

Fittings & Tubing

Flow Control Equipment

Pressure Switches/ Pressure Sensors



**Type 20 Manifold: Top Ported/10-SS5YJ3-20- Stations**

\* [ ]: AC

**Grommet (G)**

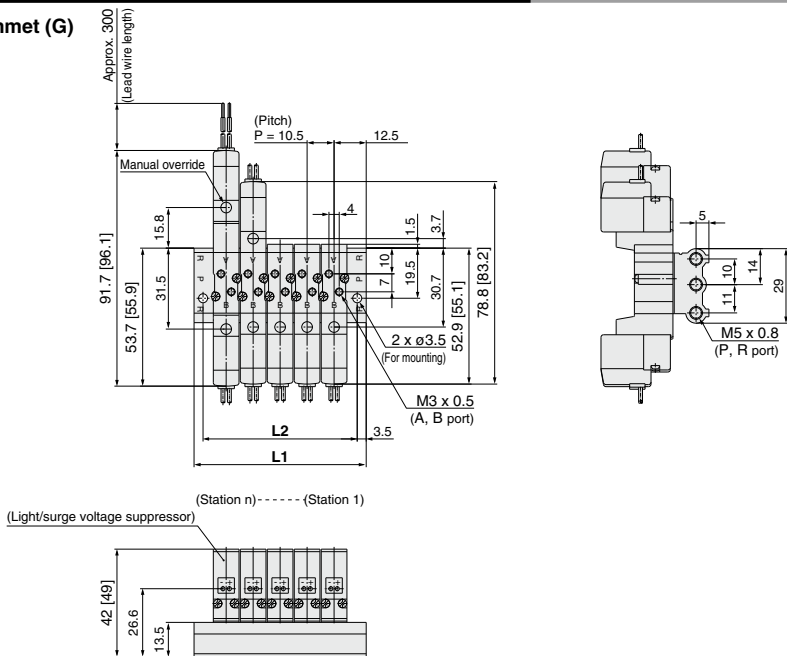

**L plug connector (L)**

**M plug connector (M)**

**M8 connector (WO)**

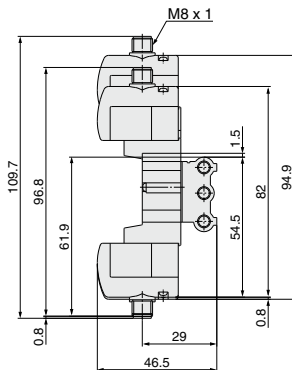
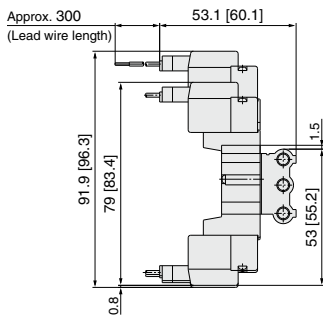
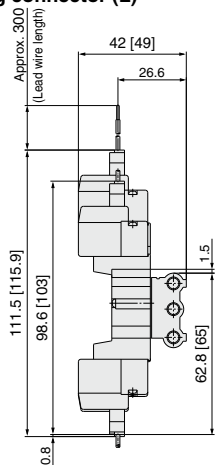

\* Refer to page 375 for dimensions with connector cable.

Station	Station 2	3	4	5	6	7	8	9	10	11	12	13	14	15	16	17	18	19	Station 20
L1	35.5	46	56.5	67	77.5	88	98.5	109	119.5	130	140.5	151	161.5	172	182.5	193	203.5	214	224.5
L2	28.5	39	49.5	60	70.5	81	91.5	102	112.5	123	133.5	144	154.5	165	175.5	186	196.5	207	217.5

**Type 31 Manifold: Side Ported/10-SS5YJ3-31- Stations -M3**

\* [ ] : AC

**Grommet (G)**

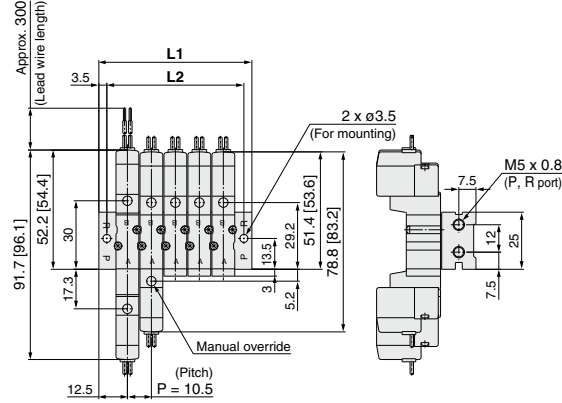

**Type S31 Manifold: Side Ported**  
**10-SS5YJ3-S31- Stations -M3**

(Single solenoid pilot valve is on same side as the A, B port.)

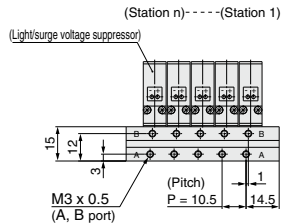
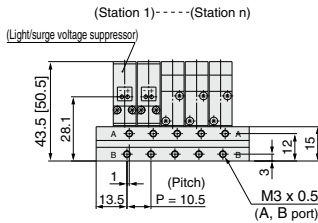
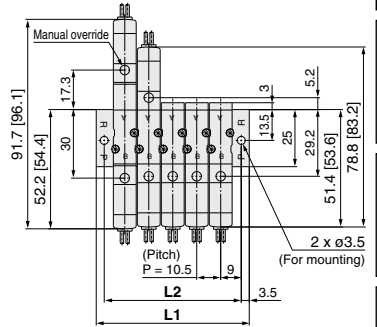

**L plug connector (L)**

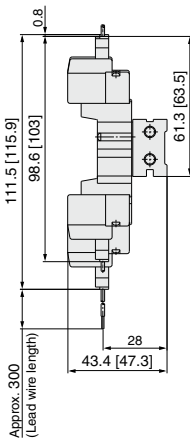

**M plug connector (M)**

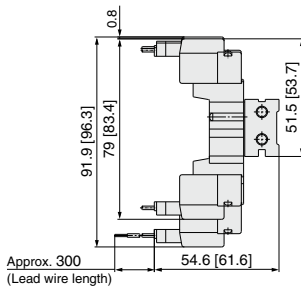

**M8 connector (WO)**

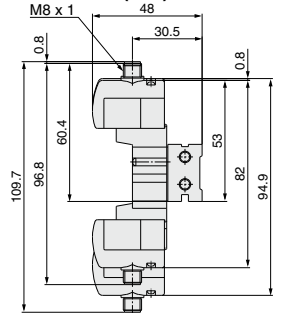

\* Refer to page 375 for dimensions with connector cable.

Station	Station 2	3	4	5	6	7	8	9	10	11	12	13	14	15	16	17	18	19	Station 20
L1	35.5	46	56.5	67	77.5	88	98.5	109	119.5	130	140.5	151	161.5	172	182.5	193	203.5	214	224.5
L2	28.5	39	49.5	60	70.5	81	91.5	102	112.5	123	133.5	144	154.5	165	175.5	186	196.5	207	217.5

**Type 32 Manifold: Side Ported/10-SS5YJ3-32-** Stations -M5, **C4** **N3** □

\* [ ] : AC

**Grommet (G)**  
For M5

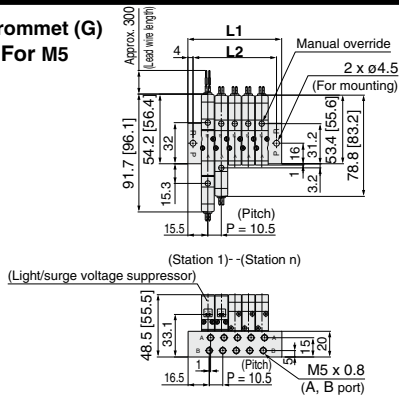

For **C4** **N3** □ (Built-in One-touch fitting)

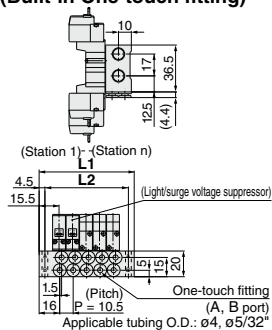

**L plug connector (L)**

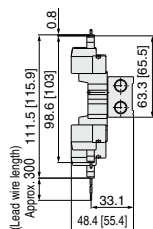

**M plug connector (M)**

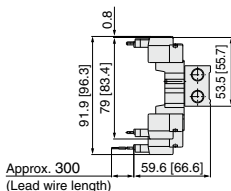

**M8 connector (WO)**

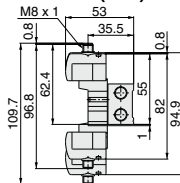

\* Refer to page 375 for dimensions with connector cable.

**Type S32 Manifold: Side Ported** (Single solenoid pilot valve is on same side as the A, B port.) /10-SS5YJ3-S32- Stations -M5, **C4** **N3** □

For M5

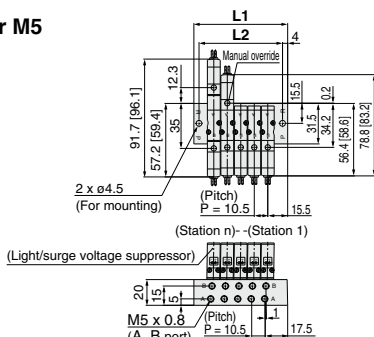

For **C4** **N3** □ (Built-in One-touch fitting)

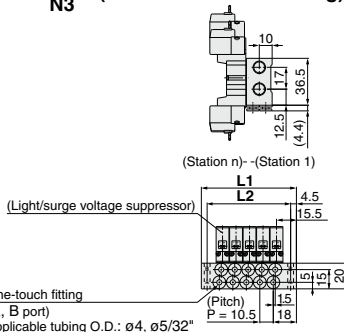

**10-SS5YJ3-32, S32- Stations -M5**

Station	Station 2	3	4	5	6	7	8	9	10	11	12	13	14	15	16	17	18	19	Station 20
L1	41.5	52	62.5	73	83.5	94	104.5	115	125.5	136	146.5	157	167.5	178	188.5	199	209.5	220	230.5
L2	33.5	44	54.5	65	75.5	86	96.5	107	117.5	128	138.5	149	159.5	170	180.5	191	201.5	212	222.5

**10-SS5YJ3-32, S32- Stations -C4**

Station	Station 2	3	4	5	6	7	8	9	10	11	12	13	14	15	16	17	18	19	Station 20
L1	42.5	53	63.5	74	84.5	95	105.5	116	126.5	137	147.5	158	168.5	179	189.5	200	210.5	221	231.5
L2	33.5	44	54.5	65	75.5	86	96.5	107	117.5	128	138.5	149	159.5	170	180.5	191	201.5	212	222.5

Type 41 Manifold: Side Ported/10-SS5YJ3-41- Stations -M5, C4 N3 □

\* [ ] : AC

Grommet (G)  
For M5

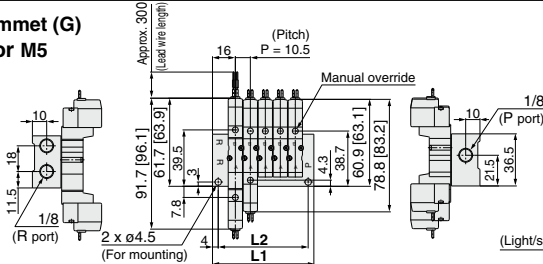

For C4 N3 □ (Built-in One-touch fitting)

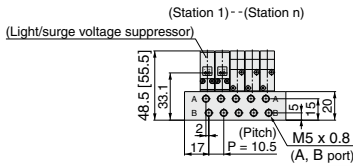
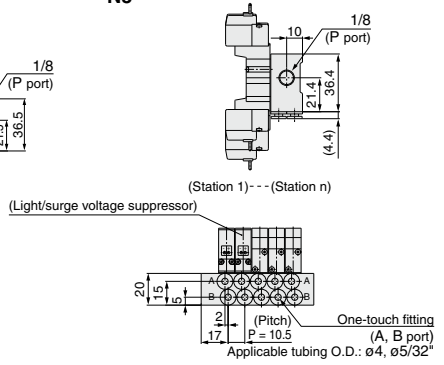

L plug connector (L)

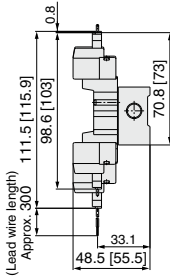

M plug connector (M)

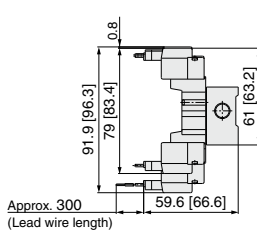

M8 connector (WO)

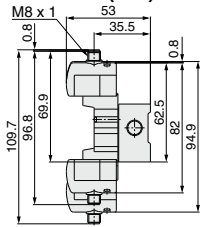

\* Refer to page 375 for dimensions with connector cable.

Type S41 Manifold: Side Ported (Single solenoid pilot valve is on same side as the A, B port.) /10-SS5YJ3-S41- Stations -M5, C4 N3 □

For M5

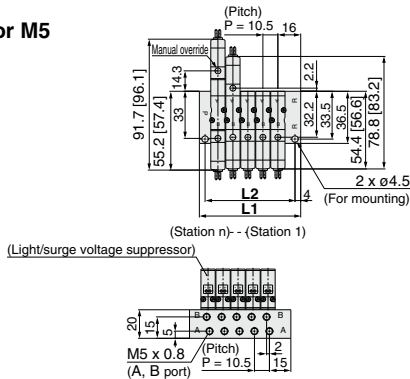

For C4 N3 □ (Built-in One-touch fitting)

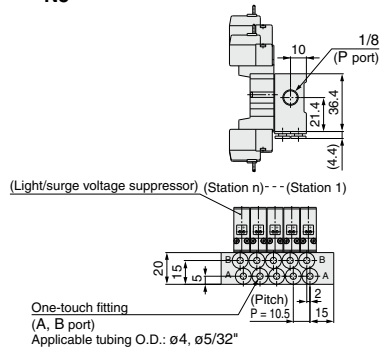

Station	Station 2	3	4	5	6	7	8	9	10	11	12	13	14	15	16	17	18	19	Station 20
L1	39.5	50	60.5	71	81.5	92	102.5	113	123.5	134	144.5	155	165.5	176	186.5	197	207.5	218	228.5
L2	31.5	42	52.5	63	73.5	84	94.5	105	115.5	126	136.5	147	157.5	168	178.5	189	199.5	210	220.5

Directional Control Valves  
Air Cylinders  
Rotary Actuators  
Air Grippers  
Air Preparation Equipment  
Modular F. R.  
Pressure Control Equipment  
Fittings & Tubing  
Flow Control Equipment  
Pressure Switches/ Pressure Sensors

**Type 46 Manifold: Side Ported/10-SS5YJ3-46- Stations -M5, C4 N3** □

\* [ ]: AC

**Grommet (G)  
For M5**

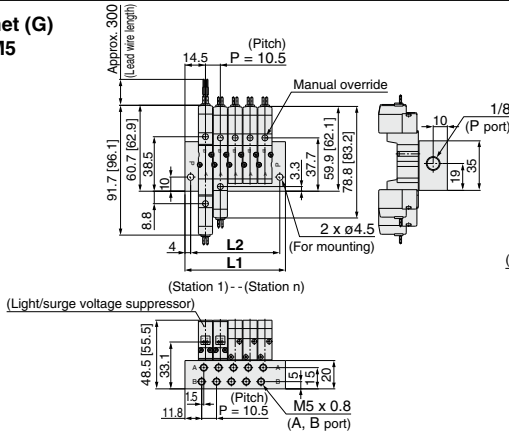

**For C4 N3** □ (Built-in One-touch fitting)

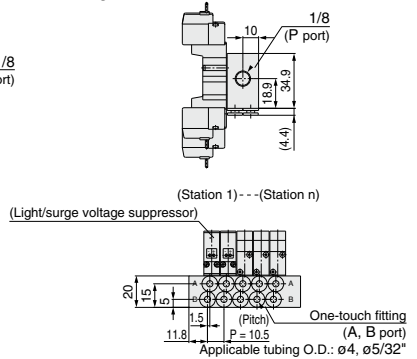

**L plug connector (L)**

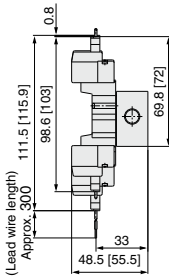

**M plug connector (M)**

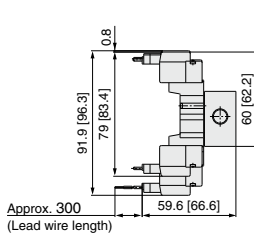

**M8 connector (WO)**

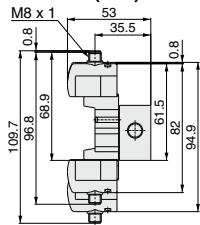

\* Refer to page 375 for dimensions with connector cable.

**Type S46 Manifold: Side Ported (Single solenoid pilot valve is on same side as the A, B port.) /10-SS5YJ3-S46- Stations -M5, C4 N3** □

**For M5**

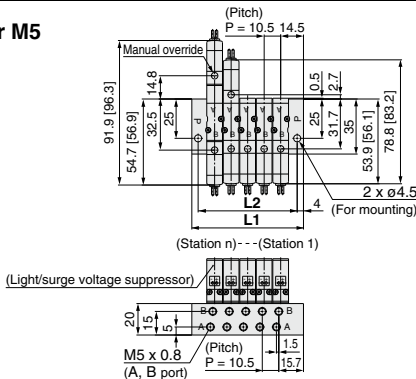

**For C4 N3** □ (Built-in One-touch fitting)

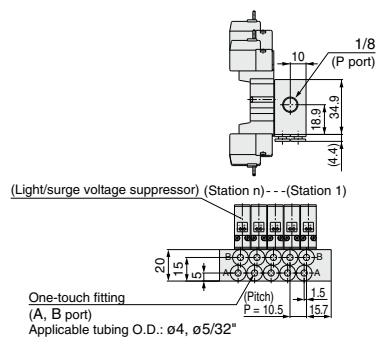

Station	Station 2	3	4	5	6	7	8	9	10	11	12	13	14	15	16	17	18	19	Station 20
L1	39.5	50	60.5	71	81.5	92	102.5	113	123.5	134	144.5	155	165.5	176	186.5	197	207.5	218	228.5
L2	31.5	42	52.5	63	73.5	84	94.5	105	115.5	126	136.5	147	157.5	168	178.5	189	199.5	210	220.5



**EX510 Gateway-type Serial Transmission System**

**10-SYJ3000: 10-SS5YJ3-21SA□-□Stations□-□**

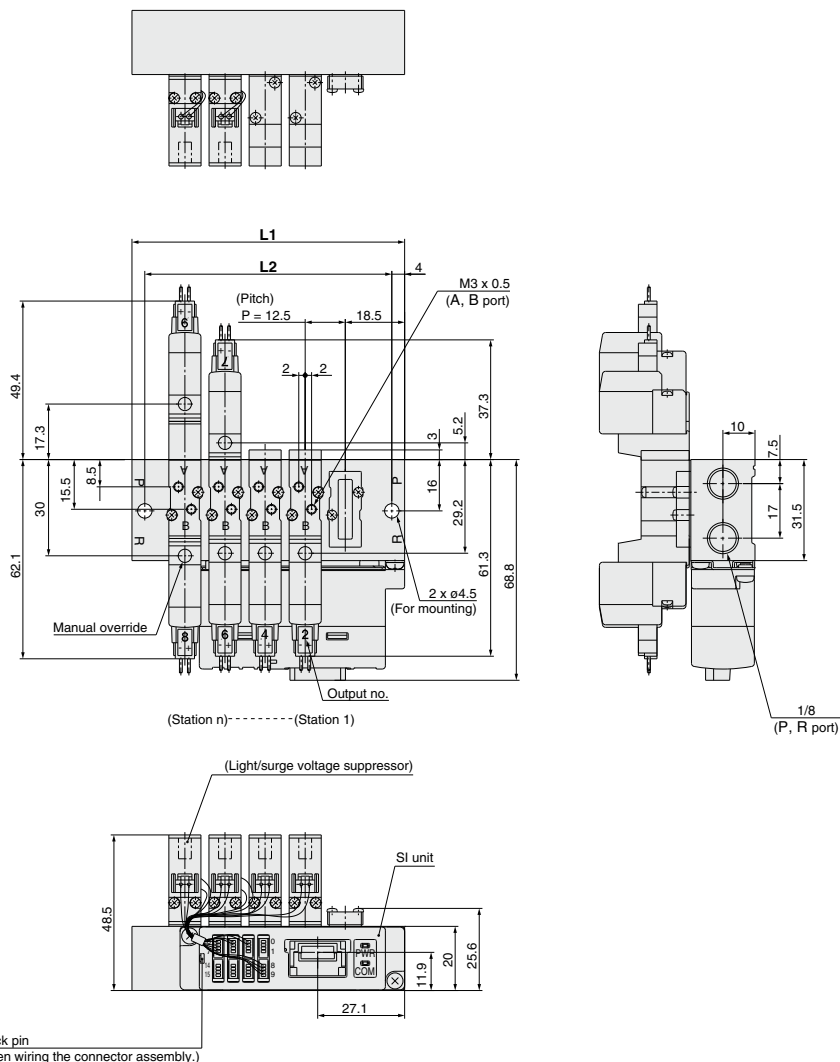

Station	Station 4	5	6	7	8	9	10	11	12	13	14	15	Station 16
<b>L1</b>	72.5	85	97.5	110	122.5	135	147.5	160	172.5	185	197.5	210	222.5
<b>L2</b>	64.5	77	89.5	102	114.5	127	139.5	152	164.5	177	189.5	202	214.5

**EX510 Gateway-type Serial Transmission System**

**10-SYJ3000: 10-SS5YJ3-32SA□-Stations-M5, C4, N3□ For C4, N3□ (Built-in One-touch fitting)**

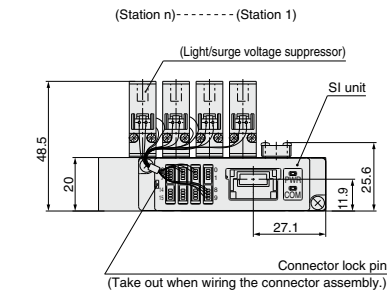
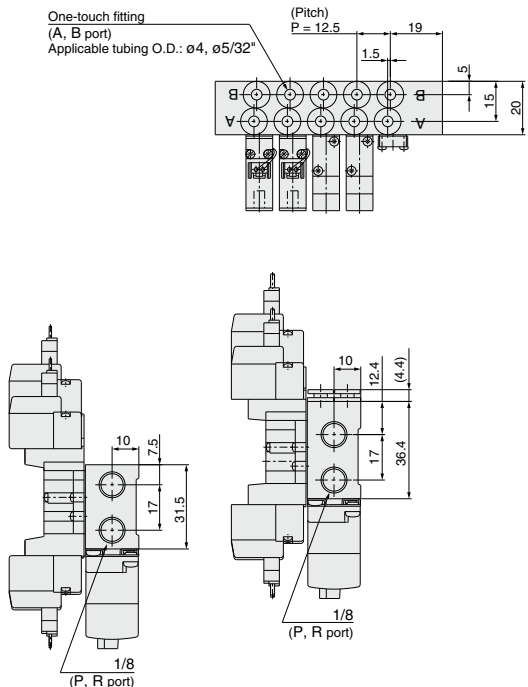
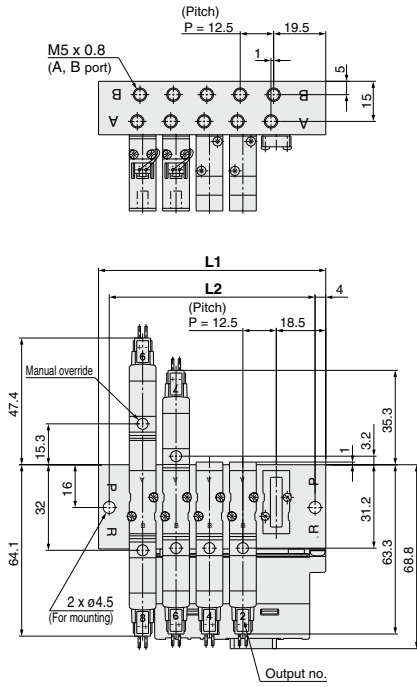

Station	Station 4	5	6	7	8	9	10	11	12	13	14	15	Station 16
L1	72.5	85	97.5	110	122.5	135	147.5	160	172.5	185	197.5	210	222.5
L2	64.5	77	89.5	102	114.5	127	139.5	152	164.5	177	189.5	202	214.5

- Directional Control Valves
- Air Cylinders
- Rotary Actuators
- Air Grippers
- Air Preparation Equipment
- Modular F. R.
- Pressure Control Equipment
- Fittings & Tubing
- Flow Control Equipment
- Pressure Switches/Pressure Sensors





**Flow Rate Characteristics/Weight**

Valve model	Actuation type	Port size		Flow rate characteristics <small>Note 1)</small>						Weight (g) <small>Note 2, 3)</small>					
		1, 5, 3 (P, EA, EB)	4, 2 (A, B)	1 → 4/2 (P → A/B)			4/2 → 5/3 (A/B → EA/EB)			Grommet	L/M plug connector	DIN terminal	M8 connector		
		C [dm <sup>3</sup> /(s·bar)]	b	Cv	C [dm <sup>3</sup> /(s·bar)]	b	Cv								
Body ported	10-SYJ5□23-□-M5	2 position	Single	M5 x 0.8	M5 x 0.8	0.47	0.41	0.13	0.47	0.41	0.13	46	47	68	51
			Double			0.49	0.44	0.13	0.44	0.40	0.12	64	66	108	74
		3 position	Closed center			0.46	0.37	0.12	0.47 [0.39]	0.43 [0.35]	0.13 [0.10]	75	77	119	85
			Exhaust center Pressure center			0.49 [0.39]	0.51 [0.38]	0.14 [0.10]	0.45	0.42	0.12				
	10-SYJ5□23-□-C4	2 position	Single	M5 x 0.8	C4 (ø4 One-touch fitting)	0.69	0.39	0.18	0.44	0.39	0.12	53	54	75	58
			Double			0.69	0.40	0.19	0.43	0.40	0.12	71	73	115	81
		3 position	Closed center			0.56	0.40	0.15	0.41 [0.41]	0.37 [0.37]	0.10 [0.11]	82	84	126	72
			Exhaust center Pressure center			0.57 [0.41]	0.4 [0.37]	0.15 [0.10]	0.41	0.37	0.10				
	10-SYJ5□23-□-C6	2 position	Single	M5 x 0.8	C6 (ø6 One-touch fitting)	0.70	0.36	0.19	0.47	0.40	0.12	53	54	75	58
			Double			0.72	0.37	0.19	0.44	0.34	0.12	71	73	115	81
		3 position	Closed center			0.67	0.54	0.19	0.41 [0.41]	0.38 [0.38]	0.11 [0.11]	82	84	126	92
			Exhaust center Pressure center			0.82 [0.44]	0.41 [0.39]	0.23 [0.12]	0.41	0.36	0.11				
Base mounted	10-SYJ5□43-□-01	2 position	Single	1/8	1/8	0.79	0.21	0.19	0.83	0.32	0.21	80 (49)	81 (47)	102 (68)	51
			Double			0.80	0.28	0.18	0.86	0.34	0.20	98 (64)	100 (66)	142 (108)	74
		3 position	Exhaust center			0.71	0.26	0.18	1.1 [0.60]	0.24 [0.44]	0.26 [0.18]	109 (75)	111 (77)	153 (119)	85
	Pressure center		0.99 [0.47]			0.29 [0.38]	0.24 [0.12]	0.72	0.38	0.18					

Note 1) [ ]: denotes normal position. Exhaust center: 4/2 → 5/3, Pressure center: 1 → 4/2

Note 2) ( ): Without sub-plate.

Note 3) For DC voltages. For AC voltages, add 3 g to the weight of the single solenoid and 6 g to the weight of the double solenoid and 3 position types.

Directional Control Valves

Air Cylinders

Rotary Actuators

Air Grippers

Air Preparation Equipment

Modular F. R.

Pressure Control Equipment

Fittings & Tubing

Flow Control Equipment

Pressure Switches/ Pressure Sensors



**How to Order**

Note) AC-type models that are CE-compliant have DIN terminals only.

[Option]

**Actuation type**

1	2 position single solenoid
2	2 position double solenoid
3	3 position closed center
4	3 position exhaust center
5	3 position pressure center

**Light/Surge voltage suppressor**

**Electrical entry for G, H, L, M, W**

<b>Nil</b>	Without light/surge voltage suppressor
<b>S</b>	With surge voltage suppressor
<b>Z</b>	With light/surge voltage suppressor
<b>R</b>	With surge voltage suppressor (Non-polar type)
<b>U</b>	With light/surge voltage suppressor (Non-polar type)

\* For AC voltage valves there is no "S" option. It is already built into the rectifier circuit.  
 \* For type "R" and "U", only DC voltage is available.  
 \* Power saving circuit is only available for the "Z" type.

**Electrical entry for D, Y**

<b>Nil</b>	Without light/surge voltage suppressor
<b>S</b>	With surge voltage suppressor (Non-polar type)
<b>Z</b>	With light/surge voltage suppressor (Non-polar type)

\* DOZ and YOZ are not available.  
 \* For AC voltage valves there is no "S" option. It is already built into the rectifier circuit.

**Rated voltage**

DC	AC (50/60 Hz)
5	1 100 VAC
6	2 200 VAC
V	3 110 VAC [115 VAC]
S	4 220 VAC [230 VAC]
R	3 VDC

\* DC specifications of type D, Y, DO and YO are only available with 12 and 24 VDC.  
 \* For type W□, only DC voltage is available. Note) AC-type models that are CE-compliant have DIN terminals only.

**A, B port size**

<b>M5</b>	M5 x 0.8
<b>C4</b>	ø4 One-touch fitting
<b>C6</b>	ø6 One-touch fitting
<b>N3</b>	ø5/32" One-touch fitting
<b>N7</b>	ø1/4" One-touch fitting

**Bracket**

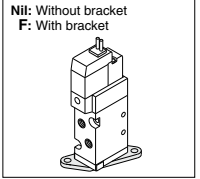

Note) The mounting bracket is supplied unattached.  
 \* 2 position single type only.

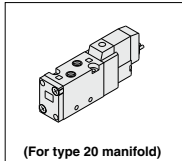

**Body ported**

**Base mounted**

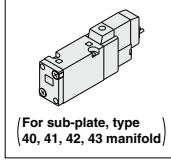

**Clean series**

**Body option**

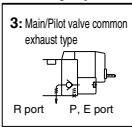

**Coil type**

<b>Nil</b>	Standard
<b>T</b>	With power saving circuit <24, 12 VDC only>

\* Power saving circuit is not available for D, Y, DO, YO or W□ types.

**CE-compliant**

<b>Nil</b>	—
<b>Q</b>	CE-compliant

Note) AC-type models that are CE-compliant have DIN terminals only.

**Thread type**

<b>Nil</b>	Rc
<b>F</b>	G
<b>N</b>	NPT
<b>T</b>	NPTF

**Manual override**

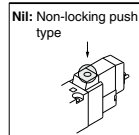

**D:** Push-turn locking slotted type

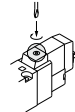

**E:** Push-turn locking lever type

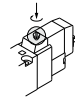

Note) When placing an order for body ported solenoid valves as a single unit, the mounting screws for the manifold and gasket are not attached. Order them separately, if necessary. (For details, refer to page 329.)

**Electrical entry**

24, 12, 6, 5, 3 VDC 100, 110, 200, 220 VAC				24, 12 VDC 100, 110, 200, 220 VAC		24, 12, 6, 5, 3 VDC	
Grommet		M plug connector		DIN terminal		M8 connector	
<b>G:</b> Lead wire length 300 mm	<b>L:</b> With lead wire (Length 300 mm)	<b>M:</b> With lead wire (Length 300 mm)	<b>MN:</b> Without lead wire	<b>D, Y:</b> With connector	<b>WO:</b> Without connector cable		
<b>H:</b> Lead wire length 600 mm	<b>LN:</b> Without lead wire	<b>LO:</b> Without connector	<b>MO:</b> Without connector	<b>DO, YO:</b> Without connector	<b>W□:</b> With connector cable (Note 1)		
CE compliant	DC	AC					

\* LN, MN type: With 2 sockets.  
 \* Refer to page 371 for the lead wire length of L and M plug connectors.  
 \* Refer to page 374 for the connector assembly with cover for L and M plug connectors.  
 \* DIN terminal type "Y" which conforms to EN-175301-803C (former DIN4365C) is also available. For details, refer to page 373.  
 \* For connector cable of M8 connector, refer to page 374.  
 \* M8 connector conforming to IEC60947-5-2 standard is also available. Refer to page 369 for details.

Note 1) Enter the cable length symbols in □. Please be sure to fill in the blank referring to page 374.



Construction

2 position single

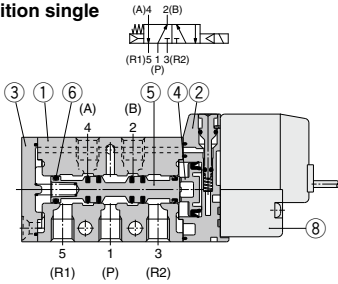

2 position double

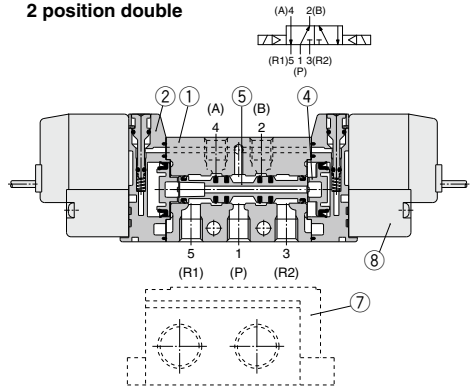

3 position closed center/exhaust center/pressure center

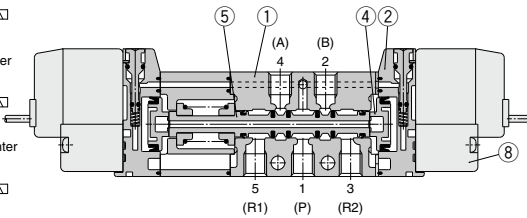
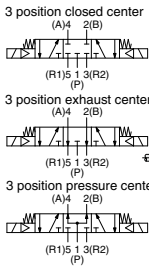

(This figure shows a closed center type.)

Component Parts

No.	Description	Material	Note
1	Body	Aluminum die-casted	White
2	Piston plate	Resin	White
3	End cover	Resin	White
4	Piston	Resin	—
5	Spool valve assembly	Aluminum, H-NBR	—
6	Spool spring	Stainless steel	—

Replacement Parts

No.	Description	Part no.	Note
7	Sub-plate <sup>(Note)</sup>	SYJ5000-22-1(-Q)	Aluminum die-casted
8	Pilot valve	V111(T)-□□□	—
—	Bracket assembly	SYJ5000-13-3A	—

\* Add suffix "-Q" for the CE-compliant product.

Directional Control Valves

Air Cylinders

Rotary Actuators

Air Grippers

Air Preparation Equipment

Modular F. R.

Pressure Control Equipment

Fittings & Tubing

Flow Control Equipment

Pressure Switches/ Pressure Sensors

### How to Order Pilot Valve Assembly

V111  -  5  G

● **Coil type**

<b>NII</b>	Standard
<b>T</b>	With power saving circuit (24, 12 VDC only)

\* Power saving circuit is not available for W  type.

● **Rated voltage**

<b>5</b>	24 VDC
<b>6</b>	12 VDC
<b>V</b>	6 VDC
<b>S</b>	5 VDC
<b>R</b>	3 VDC
<b>1</b>	100 VAC 50/60 Hz
<b>2</b>	200 VAC 50/60 Hz
<b>3</b>	110 VAC 50/60 Hz [115 VAC 50/60 Hz]
<b>4</b>	220 VAC 50/60 Hz [230 VAC 50/60 Hz]

\* For type W , only DC voltage is available.  
\* CE-compliant: For DC only.

● **Light/Surge voltage suppressor**

<b>NII</b>	Without light/surge voltage suppressor
<b>S</b>	With surge voltage suppressor
<b>Z</b>	With light/surge voltage suppressor
<b>R</b>	With surge voltage suppressor (Non-polar type)
<b>U</b>	With light/surge voltage suppressor (Non-polar type)

\* For AC voltage valves there is no "S" option. It is already built into the rectifier circuit.  
\* For type "R" and "U", only DC voltage is available.  
\* Power saving circuit is only available for the "Z" type.

● **Electrical entry**

<b>G</b>	Grommet, 300 mm lead wire
<b>H</b>	Grommet, 600 mm lead wire
<b>L</b>	With lead wire
<b>LN</b>	L plug connector Without lead wire
<b>LO</b>	Without connector
<b>M</b>	With lead wire
<b>MN</b>	M plug connector Without lead wire
<b>MO</b>	Without connector
<b>WO</b>	M8 Without connector cable
<b>W <input type="checkbox"/></b>	connector With connector cable <sup>Note 1)</sup>

\* For connector cable of M8 connector, refer to page 374.  
Note 1) Enter the cable length symbols in . Please be sure to fill in the blank referring to page 374.

V115 -  5  D

● **Rated voltage**

<b>5</b>	24 VDC
<b>6</b>	12 VDC
<b>1</b>	100 VAC 50/60 Hz
<b>2</b>	200 VAC 50/60 Hz
<b>3</b>	110 VAC 50/60 Hz [115 VAC 50/60 Hz]
<b>4</b>	220 VAC 50/60 Hz [230 VAC 50/60 Hz]

\* DC specifications of type D and DO are only available with 12 and 24 VDC.

\* Power saving circuit is not available for D or DO types.

● **Light/Surge voltage suppressor**

<b>NII</b>	Without light/surge voltage suppressor
<b>S</b>	With surge voltage suppressor (Non-polar type)
<b>Z</b>	With light/surge voltage suppressor (Non-polar type)

\* DOZ and YOZ are not available.  
\* For AC voltage valves there is no "S" option. It is already built into the rectifier circuit.

● **Electrical entry**

<b>D</b>	DIN terminal	With connector
<b>DO</b>	(Type D)	Without connector
<b>Y</b>	DIN terminal	With connector
<b>YO</b>	(Type Y)	Without connector

Note) Do not replace V111 (G, H, L, M, W) with V115 (DIN terminal) and vice versa when replacing pilot valve assembly only.

Note) Since V111 and V115 are CE-compliant as standard, the suffix "-Q" is not necessary.

**2 Position Single**

\* [ ] : AC

**Grommet (G), (H): 10-SYJ5123-□<sup>G</sup>□□-M5**

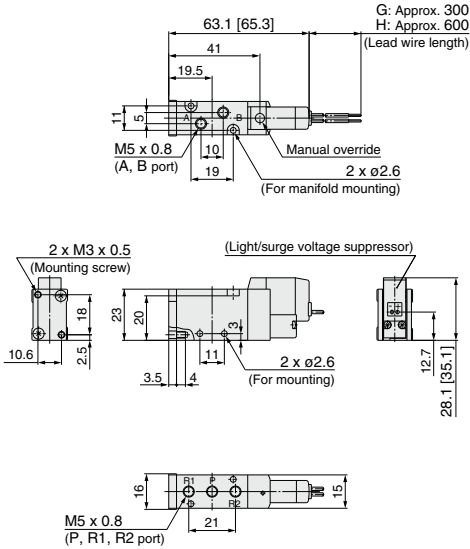

**With bracket:  
10-SYJ5123-□<sup>G</sup>□□-M5-F**

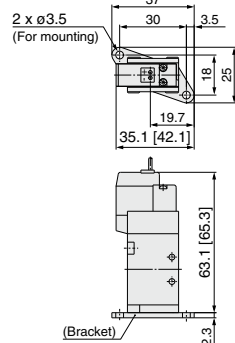

**Built-in One-touch fitting:  
10-SYJ5123-□<sup>G</sup>□□-C4, N3  
C6, N7 (-F)**

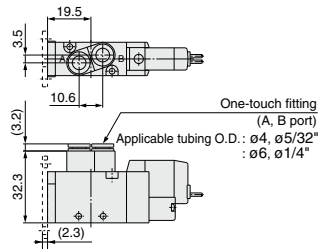

**L plug connector (L):  
10-SYJ5123-□L□□-M5(-F)**

**M plug connector (M):  
10-SYJ5123-□M□□-M5(-F)**

**DIN terminal (D, Y):  
10-SYJ5123-□□□-M5(-F)**

**M8 connector (WO):  
10-SYJ5123-□WO□□-M5(-F)**

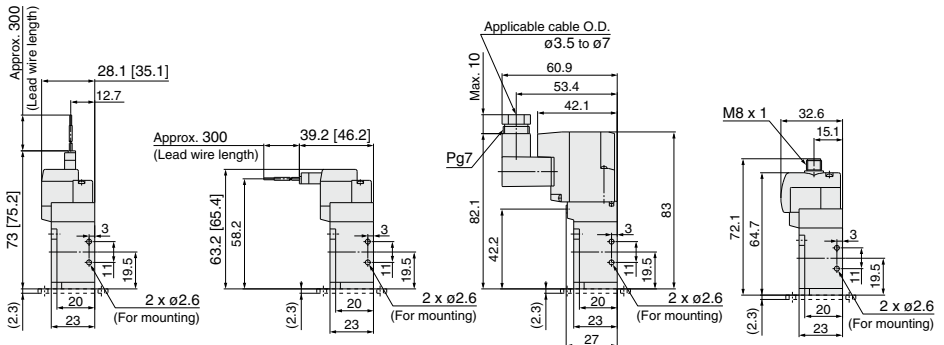

\* Refer to page 375 for dimensions with connector cable.

**2 Position Double**

\* [ ]: AC

Grommet (G), (H): 10-SYJ5223-□<sup>G</sup>□□-M5

**Built-in One-touch fitting:**  
10-SYJ5223-□<sup>G</sup>□□-C4, N3  
□□-C6, N7

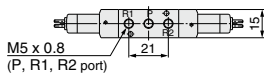
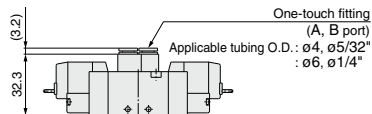
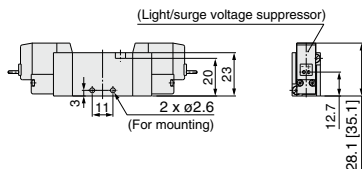
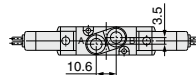
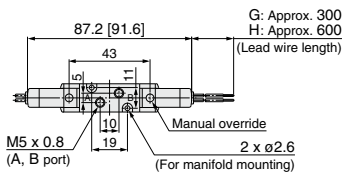

**L plug connector (L):** 10-SYJ5223-□L□□-M5

**M plug connector (M):** 10-SYJ5223-□M□□-M5

**DIN terminal (D, Y):** 10-SYJ5223-□<sup>D</sup>□□-M5

**M8 connector (WO):** 10-SYJ5223-□WO□□-M5

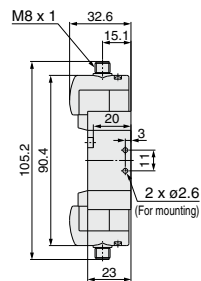
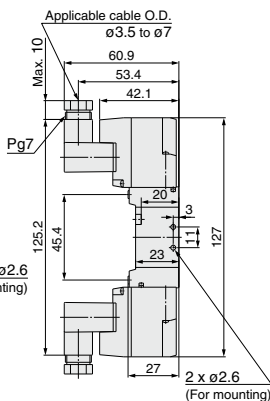
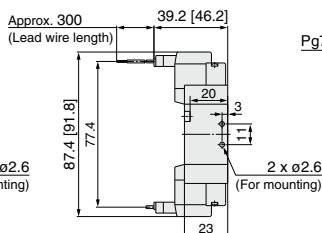
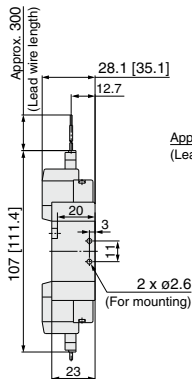

\* Refer to page 375 for dimensions with connector cable.

**3 Position Closed Center/Exhaust Center/Pressure Center**

\* [ ] : AC

**Grommet (G), (H): 10-SYJ5<sup>3</sup>/<sub>5</sub>23-□<sup>G</sup>□□-M5**

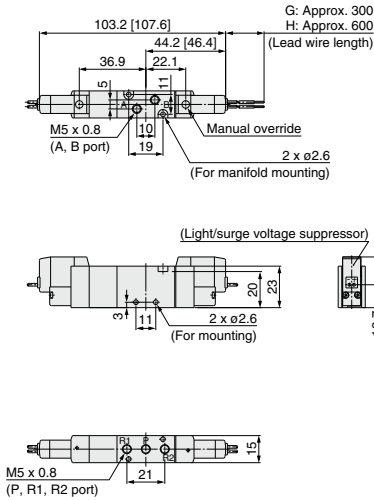

**Built-in One-touch fitting:**  
10-SYJ5<sup>3</sup>/<sub>5</sub>23-□<sup>C4, N3</sup>□□□□-C6, N7

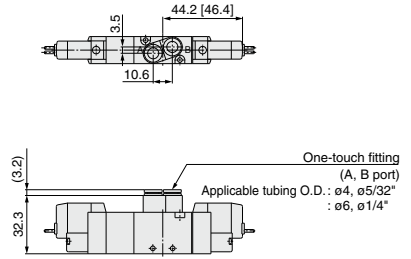

**L plug connector (L):**  
10-SYJ5<sup>3</sup>/<sub>5</sub>23-□L□□-M5

**M plug connector (M):**  
10-SYJ5<sup>3</sup>/<sub>5</sub>23-□M□□-M5

**DIN terminal (D, Y):**  
10-SYJ5<sup>3</sup>/<sub>5</sub>23-□Y□□-M5

**M8 connector (WO):**  
10-SYJ5<sup>3</sup>/<sub>5</sub>23-□WO□□-M5

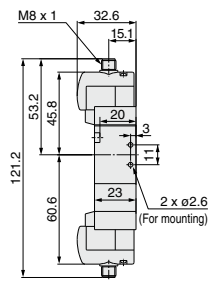
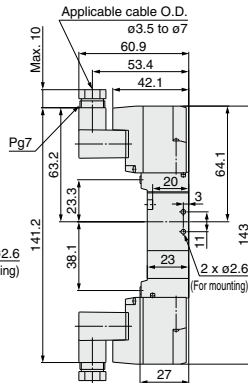
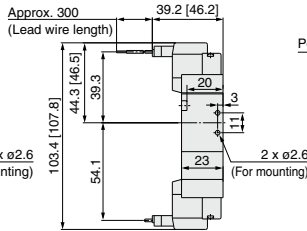
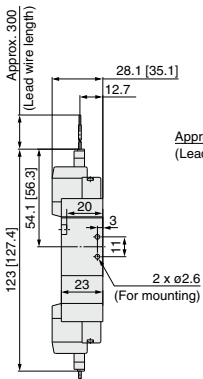

\* Refer to page 375 for dimensions with connector cable.



**2 Position Single**

\* [ ]: AC

Grommet (G), (H): 10-SYJ5143-□<sup>G</sup>□□-01□

**Built-in throttle valve:**  
10-SYJ5153-□<sup>G</sup>□□-01□

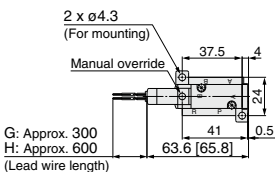
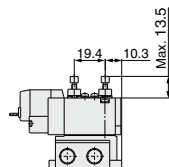
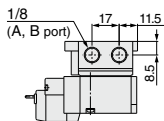

(Light/surge voltage suppressor)

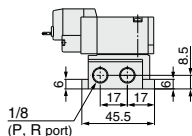
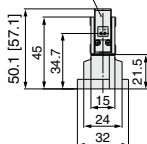

**L plug connector (L):**  
10-SYJ5143-□L□□-01□

**M plug connector (M):**  
10-SYJ5143-□M□□-01□

**DIN terminal (D, Y):**  
10-SYJ5143-□<sup>D</sup>□□-01□

**M8 connector (WO):**  
10-SYJ5143-□WO□□-01□

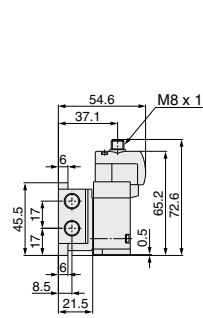
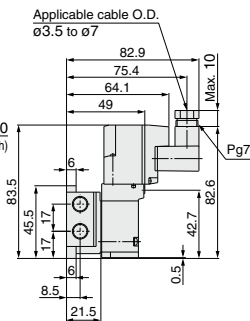
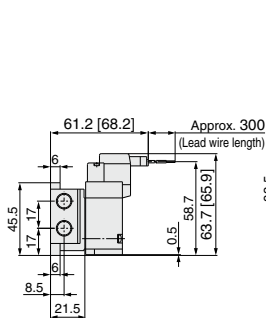
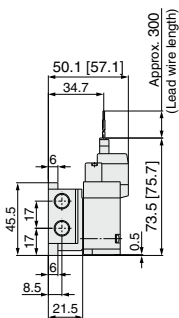

\* Refer to page 375 for dimensions with connector cable.

**2 Position Double**

\* [ ] : AC

Grommet (G), (H): 10-SYJ5243-□<sub>G</sub>□□-01□

Built-in throttle valve:  
10-SYJ5253-□<sub>H</sub>□□-01□

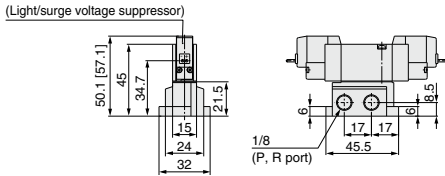
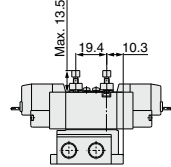
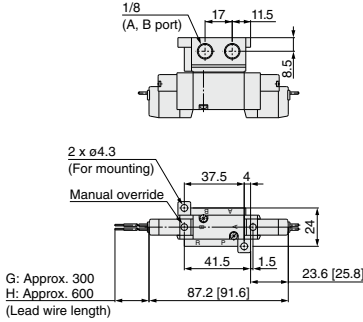

**L plug connector (L):**  
10-SYJ5243-□L□□-01□

**M plug connector (M):**  
10-SYJ5243-□M□□-01□

**DIN terminal (D, Y):**  
10-SYJ5243-□<sub>D</sub>□□-01□

**M8 connector (WO):**  
10-SYJ5243-□WO□□-01□

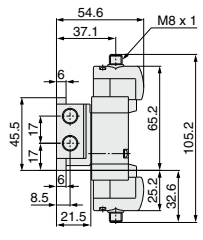
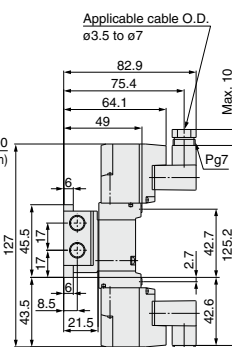
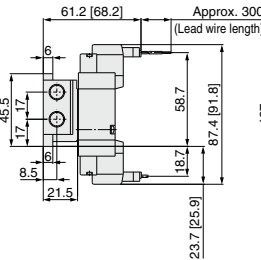
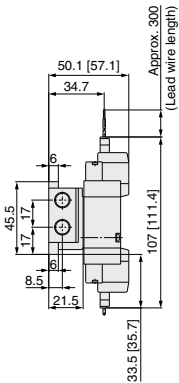

\* Refer to page 375 for dimensions with connector cable.

Directional Control Valves

Air Cylinders

Rotary Actuators

Air Grippers

Air Preparation Equipment

Modular F. R.

Pressure Control Equipment

Fittings & Tubing

Flow Control Equipment

Pressure Switches/ Pressure Sensors

**3 Position Closed Center/Exhaust Center/Pressure Center**

\* [ ] : AC

Grommet (G), (H): 10-SYJ5<sup>3/4</sup><sub>5</sub>-□<sup>G</sup><sub>H</sub>□□-01□

**Built-in throttle valve:**  
10-SYJ5<sup>3/4</sup><sub>5</sub>-□<sup>G</sup><sub>H</sub>□□-01□

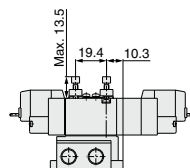
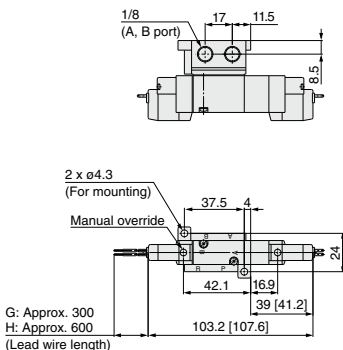

(Light/surge voltage suppressor)

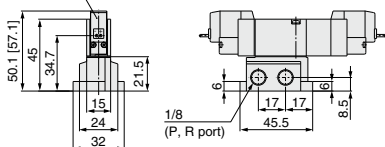

**L plug connector (L):**

10-SYJ5<sup>3/4</sup><sub>5</sub>-□43-□L□□-01□

**M plug connector (M):**

10-SYJ5<sup>3/4</sup><sub>5</sub>-□43-□M□□-01□

**DIN terminal (D, Y):**

10-SYJ5<sup>3/4</sup><sub>5</sub>-□43-□<sup>D</sup><sub>Y</sub>□□-01□

**M8 connector (WO):**

10-SYJ5<sup>3/4</sup><sub>5</sub>-□43-□WO□□-01□

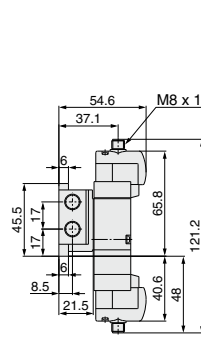
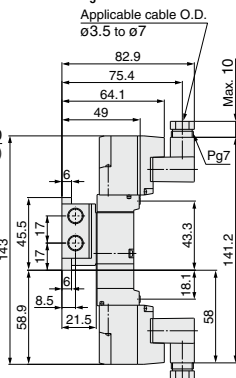
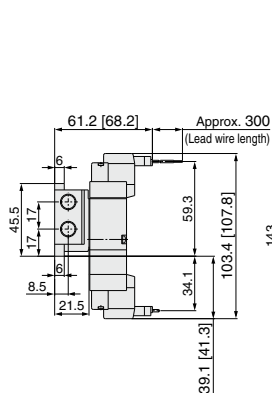
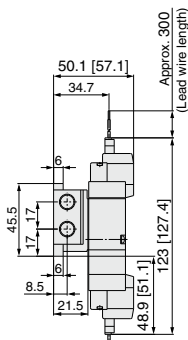

\* Refer to page 375 for dimensions with connector cable.

# Manifold Specifications



## Standard Manifold



### Manifold Specifications

Model		Type 20	Type 40	Type 41	Type 42	Type 43
<b>Manifold type</b>		Single base/B mount				
<b>P (SUP), R (EXH)</b>		Common SUP, Common EXH				
<b>Valve stations</b>		2 to 20 stations				
<b>A, B port Porting specifications</b>	<b>Location</b>	Valve	Base	Base		
	<b>Direction</b>	Top	Bottom	Side		
<b>Port size</b>	<b>P, R port</b>	1/8			1/4	1/8
	<b>A, B port</b>	M5 x 0.8, C4 (ø4 One-touch fitting) C6 (ø6 One-touch fitting)	M5 x 0.8		1/8, C6 (ø6 One-touch fitting)	C4 (ø4 One-touch fitting)

### Flow Rate Characteristics

Manifold		Port size	Flow rate characteristics						
			1 → 4/2 (P → A/B)			4/2 → 5/3 (A/B → R)			
			1(P), 5/3(R) port	2(B), 4(A) port	C [dm <sup>3</sup> /(s·bar)]	b	Cv	C [dm <sup>3</sup> /(s·bar)]	b
Body ported for internal pilot	Type 10-SS5YJ5-20 10-SYJ5-23	1/8	M5 x 0.8	0.46	0.39	0.12	0.75	0.32	0.19
		1/8	C4	0.62	0.33	0.16	0.83	0.27	0.20
		1/8	C6	0.79	0.36	0.21	0.91	0.36	0.24
Base mounted for internal pilot	Type 10-SS5YJ5-40 Type 10-SS5YJ5-41 Type 10-SS5YJ5-42-C6 10-SYJ5-43 Type 10-SS5YJ5-43	1/8	M5 x 0.8	0.55	0.35	0.15	0.64	0.26	0.16
		1/8	M5 x 0.8	0.59	0.35	0.16	0.68	0.23	0.17
		1/4	1/8	0.74	0.22	0.18	0.82	0.31	0.21
		1/4	C6	0.71	0.24	0.17	0.8	0.29	0.20
		1/8	C4	0.55	0.29	0.14	0.74	0.32	0.19

Note) The values are for individually operated 2 position type manifold bases.

### How to Order Manifold (Example)

Instruct by specifying the valves and blanking plate assembly to be mounted on the manifold along with the manifold base model no.

- Example: **10-SS5YJ5-20-03** ..... 1 pc. (Manifold base)  
 \* **10-SYJ5123-5G-M5** ..... 2 pcs. (Valve)  
 \* **SYJ5000-21-5A** ..... 1 pc. (Blanking plate assembly)
- 10-SS5YJ5-43-03-C4** ..... 1 pc. (Manifold base)  
 \* **10-SYJ5143-5LZ** ..... 1 pc. (Valve)  
 \* **10-SYJ5243-5LZ** ..... 1 pc. (Valve)  
 \* **SYJ5000-21-6A** ..... 1 pc. (Blanking plate assembly)

↳ The asterisk denotes the symbol for assembly. Prefix it to the part no. of the solenoid valve, etc.

\* Use manifold specification sheet.

Directional Control Valves

Air Cylinders

Rotary Actuators

Air Grippers

Air Preparation Equipment

Modular F. R.

Pressure Control Equipment

Fittings & Tubing

Flow Control Equipment

Pressure Switches/ Pressure Sensors



**Flat Ribbon Cable Manifold**

Note) CE-compliant:  
For DC only. [Option]

• **Multiple valve wiring is simplified through the use of the flat ribbon cable connector.**

• **Clean appearance**  
For flat ribbon cables, each valve is wired on the print board of the manifold base to allow the external wiring to be piped all together with the 26 pin MIL connector.

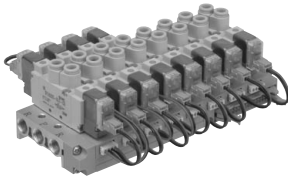

**Flat Ribbon Cable Manifold Specifications**

Model		Type 20	Type 41P	Type 43P
<b>Manifold type</b>		Single base/B mount		
<b>P (SUP), R (EXH)</b>		Common SUP, Common EXH		
<b>Valve stations</b>		3 to 12 stations		
<b>A, B port</b>	<b>Location</b>	Valve	Base	
<b>Porting specifications</b>	<b>Direction</b>	Top		Side
	<b>P, R port</b>	1/8		1/8
<b>Port size</b>	<b>A, B port</b>	M5 x 0.8, C4 (ø4 One-touch fitting) C6 (ø6 One-touch fitting)	M5 x 0.8	C4 (ø4 One-touch fitting)
<b>Applicable flat ribbon cable connector</b>		Socket: 26 pin MIL type with strain relief (Conforming to MIL-C-83503)		
<b>Internal wiring</b>		Common between +COM and -COM (Z type: +COM only).		
<b>Rated voltage</b> (Note 2)		24, 12 VDC/100, 110 VAC		

Note 1) The withstand voltage specifications for the wiring unit section conforms to JIS C 0704, Grade 1 or its equivalent.  
Note 2) CE-compliant: For DC only.

**Flow Rate Characteristics**

Manifold		Port size		Flow rate characteristics					
				1 → 4/2 (P → A/B)			4/2 → 5/3 (A/B → R)		
				C	b	Cv	C	b	Cv
Body ported for internal pilot	Type 10-SS5YJ5-20P	1/8	M5 x 0.8	0.46	0.39	0.12	0.75	0.32	0.19
	10-SYJ5-23	1/8	C4	0.62	0.33	0.16	0.83	0.27	0.20
		1/8	C6	0.79	0.36	0.21	0.91	0.36	0.24
Base mounted for internal pilot	Type 10-SS5YJ5-41P	1/8	M5 x 0.8	0.59	0.35	0.16	0.68	0.23	0.17
	10-SYJ5-43	1/8	C4	0.55	0.29	0.14	0.74	0.32	0.19

Note) The values are for individually operated 2 position type manifold bases.

**How to Order Manifold (Example)**

Instruct by specifying the valves and blanking plate assembly to be mounted on the manifold along with the manifold base model no.

- Example:
- 10-SS5YJ5-41P-07-C4 (-Q) ... 1 pc. (Manifold base)
  - \* 10-SYJ5143-SLOU (-Q) ..... 3 pcs. (Valve)
  - \* 10-SYJ5243-SLOU (-Q) ..... 3 pcs. (Valve)
  - \* SYJ5000-21-8A ..... 1 pc. (Blanking plate assembly)
  - \* SY3000-37-28A ..... 3 pcs. (Connector assembly)
  - \* SY3000-37-29A ..... 3 pcs. (Connector assembly)

↳ The asterisk denotes the symbol for assembly. Prefix it to the part no. of the solenoid valve, etc.

Note) Please indicate the connector assembly part no. below that connects the valve and the manifold.

**How to Order Valve**

Note) CE-compliant:  
For DC only. [Option]

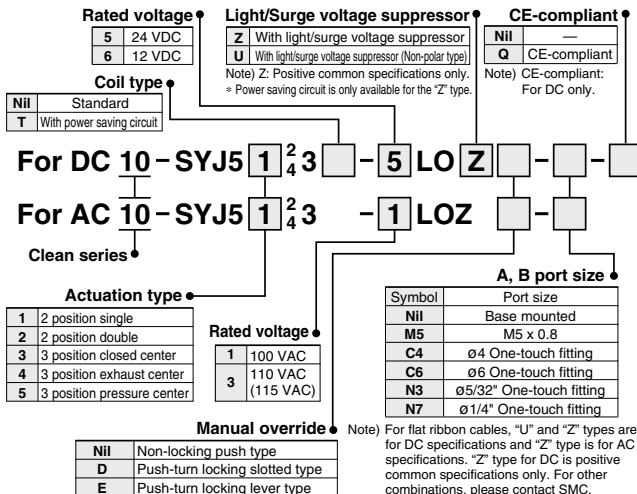

Note) For flat ribbon cables, "U" and "Z" types are for DC specifications and "Z" type is for AC specifications. "Z" type for DC is positive common specifications only. For other combinations, please contact SMC.

**Connector Assembly**

<b>20P</b>	
<b>For 12, 24 VDC</b>	
Single solenoid	SY3000-37-28A
Double solenoid, 3 position type	SY3000-37-29A
Single solenoid	SY3000-37-3A
With individual EXH spacer assembly	
Double solenoid, 3 position type	SY3000-37-4A
With individual EXH spacer assembly	
With 3 port adapter plate	SY3000-37-3A
<b>For 100 VAC</b>	
Single solenoid	SY3000-37-46A
Double solenoid, 3 position type	SY3000-37-47A
Single solenoid	SY3000-37-32A
With individual EXH spacer assembly	
Double solenoid, 3 position type	SY3000-37-33A
With individual EXH spacer assembly	
With 3 port adapter plate	SY3000-37-32A
<b>For 110 VAC</b>	
Single solenoid	SY3000-37-54A
Double solenoid, 3 position type	SY3000-37-55A
Single solenoid	SY3000-37-35A
With individual EXH spacer assembly	
Double solenoid, 3 position type	SY3000-37-36A
With individual EXH spacer assembly	
With 3 port adapter plate	SY3000-37-35A



**EX510 Gateway-type Serial Transmission System**

**Manifold for EX510 Serial Wiring Specifications**

Model		Type 20SA	Type 41SA	Type 42SA	Type 43SA
Manifold type		Single base/B mount			
P (SUP), R (EXH)		Common SUP, Common EXH			
Valve stations		3 to 16 stations			
A, B port Porting specifications	Location	Valve	Base		
	Direction	Top	Side		
Port size	P, R port	1/8			1/4
	A, B port	M5 x 0.8 C4(ø4 One-touch fitting) C6(ø6 One-touch fitting)	M5 x 0.8	1/8	C4 (ø4 One-touch fitting)
Rated voltage		24 VDC			

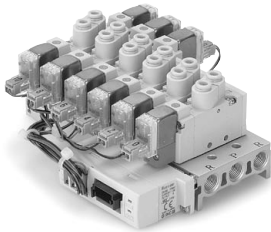

Type 20SA

**Flow Rate Characteristics**

Manifold		Port size	Flow rate characteristics							
			1 → 4/2(P → A/B)			4/2 → 5/3(A/B → R)				
			C	b	Cv	C	b	Cv		
Body ported for internal pilot	Type 10-SSSYJ5-20SA	10-SYJ5□23	1/8	M5 x 0.8	0.46	0.39	0.12	0.75	0.32	0.19
			1/8	C4	0.62	0.33	0.16	0.83	0.27	0.20
Base mounted for internal pilot	Type 10-SSSYJ5-41SA		1/8	M5 x 0.8	0.79	0.36	0.21	0.91	0.36	0.24
	Type 10-SSSYJ5-42SA-01	10-SYJ5□43	1/8	M5 x 0.8	0.59	0.35	0.16	0.68	0.23	0.17
	Type 10-SSSYJ5-43SA		1/4	1/8	0.74	0.22	0.18	0.82	0.31	0.21
			1/8	C4	0.55	0.29	0.14	0.74	0.32	0.19

Note) The values are for individually operated 2 position type manifold bases.

**How to Order Manifold (Example)**

10-SSSYJ5-20SA-05 .....	1 set (Type 20SA, 5-station manifold part no.)
* 10-SYJ5123-5LOU-M5 .....	3 sets (Single solenoid part no.)
* 10-SYJ5223-5LOU-M5 .....	2 sets (Double solenoid part no.)
↳ The asterisk denotes the symbol for assembly. Prefix it to the part no. of the solenoid valve, etc.	

Add the valve and option part number under the manifold base part number.

When entry of part numbers becomes complicated, indicate by the manifold specification sheet. For an EX510 manifold, the length of the lead wire for a connector assembly depends on the number of stations. Therefore, the manifold assembly is shipped with the valves (including blanking plates) and connector assembly mounted on it, as the standard specification. Be sure to specify the part no. of the solenoid valves to be mounted.

**Type 41P, 43P**

For 12, 24 VDC	
Single solenoid	SY3000-37-28A
Double solenoid, 3 position type	SY3000-37-29A
Single solenoid With individual SUP/EXH spacer assembly	SY3000-37-3A
Double solenoid, 3 position type With individual SUP/EXH spacer assembly	SY3000-37-4A
Single solenoid With interface regulator	SY3000-37-3A
Double solenoid, 3 position type With interface regulator	SY3000-37-6A
With 3 port adapter plate	SY3000-37-3A

**For 100 VAC**

Single solenoid	SY3000-37-46A
Double solenoid, 3 position type	SY3000-37-47A
Single solenoid With individual SUP/EXH spacer assembly	SY3000-37-32A
Double solenoid, 3 position type With individual SUP/EXH spacer assembly	SY3000-37-33A
Single solenoid With interface regulator	SY3000-37-15A
Double solenoid, 3 position type With interface regulator	SY3000-37-34A
With 3 port adapter plate	SY3000-37-32A

**For 110 VAC**

Single solenoid	SY3000-37-54A
Double solenoid, 3 position type	SY3000-37-55A
Single solenoid With individual SUP/EXH spacer assembly	SY3000-37-35A
Double solenoid, 3 position type With individual SUP/EXH spacer assembly	SY3000-37-36A
Single solenoid With interface regulator	SY3000-37-19A
Double solenoid, 3 position type With interface regulator	SY3000-37-37A
With 3 port adapter plate	SY3000-37-35A

Directional Control Valves

Air Cylinders

Rotary Actuators

Air Grippers

Air Preparation Equipment

Modular F. R.

Pressure Control Equipment

Fittings & Tubing

Flow Control Equipment

Pressure Switches/ Pressure Sensors

### How to Order Manifold

**10 - SS5YJ5 - 20SA** [ ] - **03** - [ ] - [ ]

- Clean series**
- SI unit**

<b>NII</b>	NPN output (+ COM.)
<b>N</b>	PNP output (- COM.)
- CE-compliant**

<b>NII</b>	—
<b>Q</b>	CE-compliant
- Valve stations**

Symbol	Stations	Note
<b>03</b>	3 stations	Double wiring <sup>Note 1)</sup>
⋮	⋮	
<b>08</b>	8 stations	
<b>03</b>	3 stations	Specified layout <sup>Note 2)</sup> (Up to 16 solenoids)
⋮	⋮	
<b>16</b>	16 stations	
- P, R port thread type**

<b>NII</b>	Rc
<b>00F</b>	G
<b>00N</b>	NPT
<b>00T</b>	NPTF
- SI unit part no.**

Symbol	SI unit specifications	SI unit part no.	Page
<b>NII</b>	NPN output (+ COM.)	EX510-S001	<b>WEB</b>
<b>N</b>	PNP output (- COM.)	EX510-S101	<b>catalog</b>

\* Includes the number of the blanking plate assemblies.  
Note 1) Double wiring: Use of a single solenoid will result in an unused control signal. If this is not desired, order with a specified layout.  
Note 2) Specified layout: Indicate wiring specifications on the manifold specification sheet. (Note that double and 3 position valves cannot be used where single solenoid wiring has been specified.)

### How to Order Valve

**10 - SYJ5** **1** **23** [ ] - **5LO** **Z** [ ] - **M5** - [ ]

- Clean series**
- Rated voltage: 24 VDC**
- Light/Surge voltage suppressor**

<b>Z</b>	With light/surge voltage suppressor
<b>U</b>	With light/surge voltage suppressor (Non-polar type)

\* Power saving circuit is only available for the "Z" type.
- Manual override**

<b>NII</b>	Non-locking push type
<b>D</b>	Push-turn locking slotted type
<b>E</b>	Push-turn locking lever type
- Coil type**

<b>NII</b>	Standard
<b>T</b>	With power saving circuit
- A, B port size**

<b>M5</b>	M5 x 0.8
<b>C4</b>	ø4 One-touch fitting
<b>C6</b>	ø6 One-touch fitting
<b>N3</b>	ø5/32" One-touch fitting
<b>N7</b>	ø1/4" One-touch fitting
- CE-compliant**

<b>NII</b>	—
<b>Q</b>	CE-compliant
- Actuation type**

<b>1</b>	2 position single
<b>2</b>	2 position double
<b>3</b>	3 position closed center
<b>4</b>	3 position exhaust center
<b>5</b>	3 position pressure center

### How to Order Manifold Assembly (Example)

**Example**

Double solenoid (24 VDC)  
10-SYJ5223-5LOU-M5(-Q) (2 sets)

Single solenoid (24 VDC)  
10-SYJ5123-5LOU-M5(-Q) (3 sets)

Manifold base (5 stations)  
10-SS5YJ5-20SA-05(-Q)

Stations..... 3 2 1

**10-SS5YJ5-20SA-05 (-Q) ..... 1 set (Type 20SA, 5-station manifold part no.)**  
**\* 10-SYJ5123-5LOU-M5 (-Q) ..... 3 sets (Single solenoid part no.)**  
**\* 10-SYJ5223-5LOU-M5 (-Q) ..... 2 sets (Double solenoid part no.)**

↳ The asterisk denotes the symbol for assembly. Prefix it to the part no. of the solenoid valve, etc.

Add the valve and option part number under the manifold base part number. When entry of part numbers becomes complicated, indicate by the manifold specification sheet. For a EX510 manifold, the length of the lead wire for a connector assembly depends on the number of stations. Therefore, the manifold assembly is shipped with the valves (including blanking plates) and connector assembly mounted on it, as the standard specification. Be sure to specify the part no. of the solenoid valves to be mounted.

# Series 10-SYJ5000

EX510 Gateway-type Serial Transmission System  
Base Mounted Manifold



## How to Order Manifold

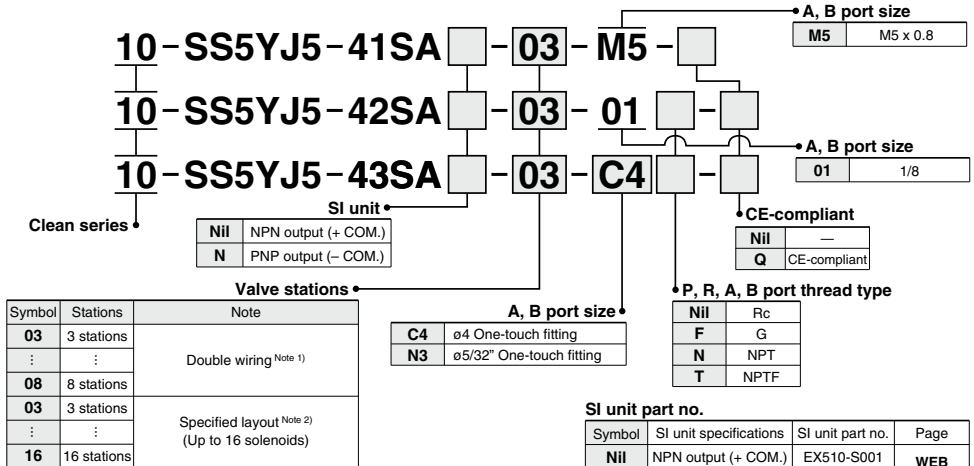

- Includes the number of the blanking plate assemblies.  
 Note 1) Double wiring: Use of a single solenoid will result in an unused control signal. If this is not desired, order with a specified layout.  
 Note 2) Specified layout: Indicate wiring specifications on the manifold specification sheet. (Note that double and 3 position valves cannot be used where single solenoid wiring has been specified.)

## How to Order Valve

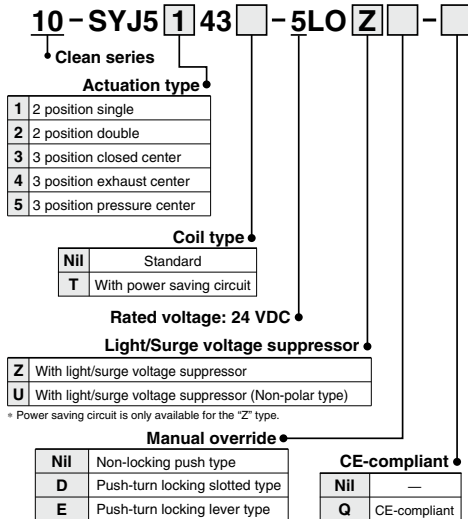

## How to Order Manifold Assembly (Example)

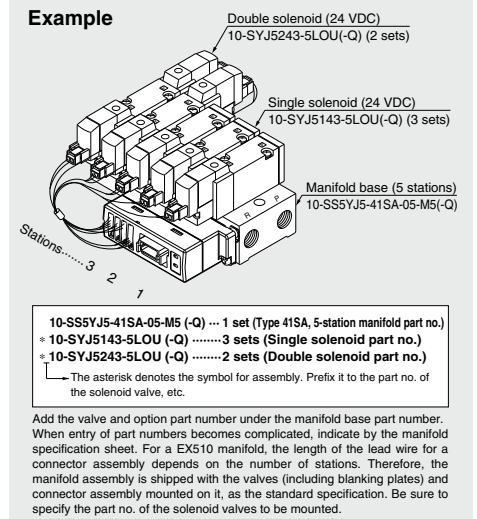

Directional Control Valves

Air Cylinders

Rotary Actuators

Air Grippers

Air Preparation Equipment

Modular F. R.

Pressure Control Equipment

Fittings & Tubing

Flow Control Equipment

Pressure Switches/ Pressure Sensors





Note) AC-type models that are CE-compliant have DIN terminals only.

[Option]

## Individual Wiring

### Common SUP/Common EXH

Note) For more than 8 stations, supply pressure to P port on both sides and exhaust from R port on both sides.

#### Type 20 (5 port/Body ported)

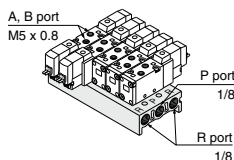

#### How to Order

**10-SS5YJ5-20-05** - [ ] - [ ]

Clean series

Number of stations

02	2 stations
:	:
20	20 stations

P, R port thread type

Nil	Rc
00F	G
00N	NPT
00T	NPTF

CE-compliant

Nil	—
Q	CE-compliant

#### Applicable solenoid valve

10-SYJ5□23-□□□□-<sup>M5</sup>N3(-Q)  
C6 N7

#### Applicable blanking plate assembly

Refer to page 329.

#### Applicable individual EXH spacer assembly

Refer to page 330.

#### Type 40 (5 port/Base mounted)

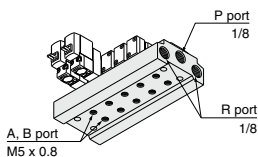

#### How to Order

**10-SS5YJ5-40-05-M5** - [ ] - [ ]

Clean series

Stations

02	2 stations
:	:
20	20 stations

A, B port size

M5	M5 x 0.8
----	----------

P, R port thread type

Nil	Rc
F	G
N	NPT
T	NPTF

CE-compliant

Nil	—
Q	CE-compliant

#### Applicable solenoid valve

10-SYJ5□43-□□□□(-Q)  
10-SYJ5□53-□□□□(-Q)

#### Applicable blanking plate assembly

Refer to page 329.

#### Applicable individual EXH spacer assembly

Refer to page 330.

#### Type 41 (5 port/Base mounted)

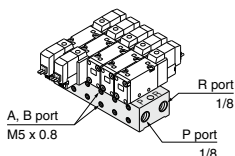

#### How to Order

**10-SS5YJ5-41-05-M5** - [ ] - [ ]

Clean series

Stations

02	2 stations
:	:
20	20 stations

A, B port size

M5	M5 x 0.8
----	----------

P, R port thread type

Nil	Rc
F	G
N	NPT
T	NPTF

CE-compliant

Nil	—
Q	CE-compliant

#### Type 42 (5 port/Base mounted)

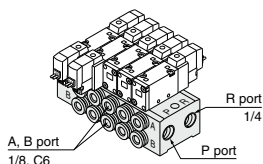

#### How to Order

**10-SS5YJ5-42-05-C6** - [ ] - [ ]

Clean series

Stations

02	2 stations
:	:
20	20 stations

A, B port size

01	1/8
C6	ø6 One-touch fitting
N7	ø1/4" One-touch fitting

Thread type

Nil	Rc
F	G
N	NPT
T	NPTF

CE-compliant

Nil	—
Q	CE-compliant

#### Applicable solenoid valve

10-SYJ5□43-□□□□(-Q)  
10-SYJ5□53-□□□□(-Q)

#### Applicable blanking plate assembly

Refer to page 329.

#### Applicable individual EXH spacer assembly

Refer to page 330.

#### Applicable individual SUP spacer assembly

Refer to page 330.

#### Type 43 (5 port/Base mounted)

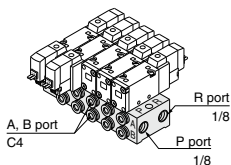

#### How to Order

**10-SS5YJ5-43-05-C4** - [ ] - [ ]

Clean series

Stations

02	2 stations
:	:
20	20 stations

A, B port size

C4	ø4 One-touch fitting
N3	ø5/32" One-touch fitting

P, R port thread type

Nil	Rc
F	G
N	NPT
T	NPTF

CE-compliant

Nil	—
Q	CE-compliant



Note) CE-compliant: For DC only. [Option]

**Flat Ribbon Cable Manifold**

**Common SUP/Common EXH**

Note) For more than 8 stations, supply pressure to P port on both sides and exhaust from R port on both sides.

**Type 20P (5 port/Body ported)**

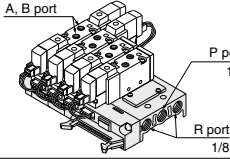

**How to Order**

**10-SS5YJ5-20P-05** - [ ] - [ ]

↓ Clean series

Number of stations

03	3 stations
:	:
12	12 stations

P, R port thread type

Nil	Rc
00F	G
00N	NPT
00T	NPTF

CE-compliant

Nil	—
Q	CE-compliant

**Applicable solenoid valve**  
Refer to page 323.

**Applicable blanking plate assembly**  
Refer to page 329.

**Applicable connector assembly**  
Refer to page 323.

**Type 41P (5 port/Base mounted)**

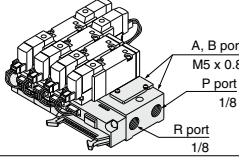

**How to Order**

**10-SS5YJ5-41P-05** - **M5** - [ ] - [ ]

↓ Clean series

Number of stations

03	3 stations
:	:
12	12 stations

P, R port thread type

Nil	Rc
F	G
N	NPT
T	NPTF

CE-compliant

Nil	—
Q	CE-compliant

**Applicable solenoid valve**  
Refer to page 323.

**Applicable blanking plate assembly**  
Refer to page 329.

**Applicable connector assembly**  
Refer to page 323.

**Type 43P (5 port/Base mounted)**

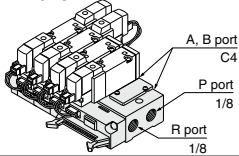

**How to Order**

**10-SS5YJ5-43P-05** - **C4** - [ ] - [ ]

↓ Clean series

Number of stations

03	3 stations
:	:
12	12 stations

A, B port size

C4	ø4 One-touch fitting
N3	ø5/32" One-touch fitting

P, R port thread type

Nil	Rc
F	G
N	NPT
T	NPTF

CE-compliant

Nil	—
Q	CE-compliant

**EX510 Gateway-type Serial Transmission System**



[Option]

**Type 20SA (5 port/Body ported)**

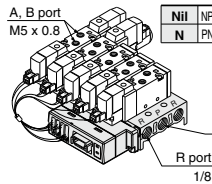

SI unit

Nil	NPN output (+COM.)
N	PNP output (-COM.)

**10-SS5YJ5-20SA** - **03** - [ ] - [ ]

↓ Clean series

Valve stations

Symbol	Stations	Note
03	3 stations	Double wiring (Note 1)
:	:	
08	8 stations	Specified layout (Note 2) (Up to 16 solenoids)
03	3 stations	
16	16 stations	

P, R port thread type

Nil	Rc
00F	G
00N	NPT
00T	NPTF

CE-compliant

Nil	—
Q	CE-compliant

**Applicable solenoid valve**  
Refer to page 325.

**Applicable blanking plate assembly**  
Refer to page 329.

Includes the number of the blanking plate assemblies.  
Note 1) Double wiring: Use of a single solenoid will result in an unused control signal. If this is not desired, order with a specified layout.  
Note 2) Specified layout: Indicate wiring specifications on the manifold specification sheet. (Note that double and 3 position valves cannot be used where single solenoid wiring has been specified.)

**Type 41SA (5 port/Base mounted)**

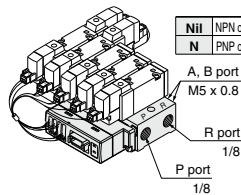

SI unit

Nil	NPN output (+COM.)
N	PNP output (-COM.)

**10-SS5YJ5-41SA** - **03** - **M5** - [ ]

↓ Clean series

Valve stations

Symbol	Stations	Note
03	3 stations	Double wiring (Note 1)
:	:	
08	8 stations	Specified layout (Note 2) (Up to 16 solenoids)
03	3 stations	
16	16 stations	

A, B port size

M5	M5 x 0.8
----	----------

CE-compliant

Nil	—
Q	CE-compliant

**Applicable solenoid valve**  
Refer to page 326.

**Applicable blanking plate assembly**  
Refer to page 329.

Includes the number of the blanking plate assemblies.  
Note 1) Double wiring: Use of a single solenoid will result in an unused control signal. If this is not desired, order with a specified layout.  
Note 2) Specified layout: Indicate wiring specifications on the manifold specification sheet. (Note that double and 3 position valves cannot be used where single solenoid wiring has been specified.)

**Type 42SA (5 port/Base mounted)**

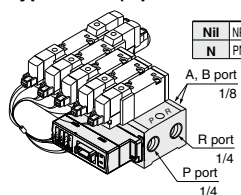

SI unit

Nil	NPN output (+COM.)
N	PNP output (-COM.)

**10-SS5YJ5-42SA** - **03** - **01** - [ ]

↓ Clean series

Valve stations

Symbol	Stations	Note
03	3 stations	Double wiring (Note 1)
:	:	
08	8 stations	Specified layout (Note 2) (Up to 16 solenoids)
03	3 stations	
16	16 stations	

P, R port thread type

Nil	Rc
F	G
N	NPT
T	NPTF

CE-compliant

Nil	—
Q	CE-compliant

**Applicable solenoid valve**  
Refer to page 326.

**Applicable blanking plate assembly**  
Refer to page 329.

Includes the number of the blanking plate assemblies.  
Note 1) Double wiring: Use of a single solenoid will result in an unused control signal. If this is not desired, order with a specified layout.  
Note 2) Specified layout: Indicate wiring specifications on the manifold specification sheet. (Note that double and 3 position valves cannot be used where single solenoid wiring has been specified.)

Directional Control Valves  
 Air Cylinders  
 Rotary Actuators  
 Air Grippers  
 Air Preparation Equipment  
 Modular F. R.  
 Pressure Control Equipment  
 Fittings & Tubing  
 Flow Control Equipment  
 Pressure Switches/Pressure Sensors

## EX510 Gateway-type Serial Transmission System

### Type 43SA (5 port/Base mounted) How to Order

**10-SS5YJ5-43SA**    - **03** - **C4**    -   

**Clean series**

A, B port  
M5 x 0.8

R port  
1/8

P port  
1/8

**SI unit**

Nil	NPN output (+ COM.)
N	PNP output (- COM.)

**Valve stations**

Symbol	Station	Note
03	3 stations	Double wiring <sup>Note 1)</sup>
:	:	
08	8 stations	
03	3 stations	Specified layout <sup>Note 2)</sup>
:	:	(Up to 16 solenoids)
16	16 stations	

**P, R, A, B port thread type**

Nil	Rc
F	G
N	NPT
T	NPTF

**A, B port size**

C4	ø4 One-touch fitting
N3	ø5/32" One-touch fitting

**Applicable solenoid valve**  
Refer to page 326.

**Applicable blanking plate assembly**  
Refer to "Blanking Plate Assembly" below.

**CE-compliant**

Nil	—
Q	CE-compliant

Note 1) Double wiring: Use of a single solenoid will result in an unused control signal. If this is not desired, order with a specified layout.  
Note 2) Specified layout: Indicate wiring specifications on the manifold specification sheet. (Note that double and 3 position valves cannot be used where single solenoid wiring has been specified.)

## Combinations of Solenoid Valve, Manifold Gasket and Manifold Base

### <Standard>

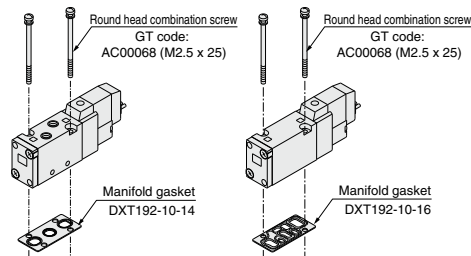

#### Applicable manifold base

- Type 10-SS5YJ5-20
- Type 10-SS5YJ5-20P
- Type 10-SS5YJ5-20SA

#### Applicable manifold base

- Sub-plate
- Type 10-SS5YJ5-41P
  - Type 10-SS5YJ5-40
  - Type 10-SS5YJ5-43P
  - Type 10-SS5YJ5-41
  - Type 10-SS5YJ5-41SA
  - Type 10-SS5YJ5-42
  - Type 10-SS5YJ5-42SA
  - Type 10-SS5YJ5-43
  - Type 10-SS5YJ5-43SA

### <CE-compliant>

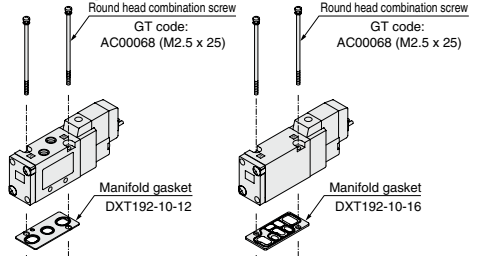

#### Applicable manifold base

- Type 10-SS5YJ5-20-Q
- Type 10-SS5YJ5-20P-Q
- Type 10-SS5YJ5-20SA-Q

#### Applicable manifold base

- Sub-plate
- Type 10-SS5YJ5-41P-Q
  - Type 10-SS5YJ5-40-Q
  - Type 10-SS5YJ5-43P-Q
  - Type 10-SS5YJ5-41-Q
  - Type 10-SS5YJ5-41SA-Q
  - Type 10-SS5YJ5-42-Q
  - Type 10-SS5YJ5-42SA-Q
  - Type 10-SS5YJ5-43-Q
  - Type 10-SS5YJ5-43SA-Q

## Blanking Plate Assembly

### SYJ5000-21-5A

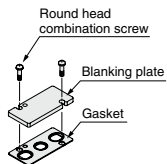

#### Applicable manifold base

- 10-SS5YJ5-20(-Q)
- 10-SS5YJ5-20SA(-Q)

### SYJ5000-21-6A

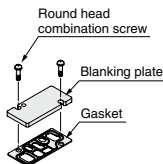

#### Applicable manifold base

- 10-SS5YJ5-40(-Q)
- 10-SS5YJ5-41(-Q)
- 10-SS5YJ5-42(-Q)
- 10-SS5YJ5-43(-Q)
- 10-SS5YJ5-41SA(-Q)
- 10-SS5YJ5-42SA(-Q)
- 10-SS5YJ5-43SA(-Q)

### SYJ5000-21-7A

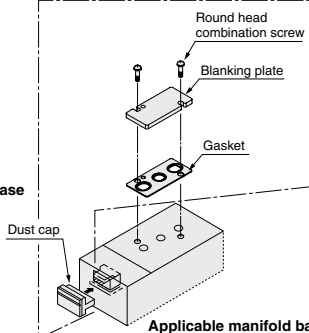

- 10-SS5YJ5-20P(-Q)

### SYJ5000-21-8A

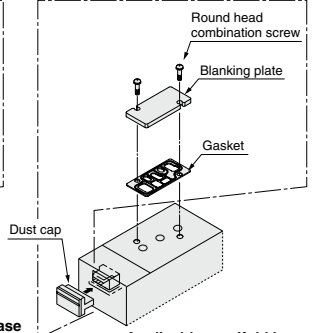

- 10-SS5YJ5-41P(-Q)
- 10-SS5YJ5-43P(-Q)

### ⚠ Caution

Mounting screw tightening torque  
M2.5: 0.45 N·m

Use caution to the assembly orientation for solenoid valves, gasket, and optional parts.

## Mix Installation of the 10-SYJ500 and the 10-SYJ5000 Valves on the Same Manifold

- Use of an adapter plate makes it possible to mount the 10-SYJ500 on the 10-SYJ5000 manifold bases.
- When mounting the SYJ500 valve on the 10-SYJ5000 manifold, the SYJ500 pilot valve must be positioned on the same side of the manifold as a SYJ5000 single solenoid. (Refer to the figure below.)
- For base mounted type, the A port of the 3 port valve flows out the B port of the manifold base.

### Adapter Plate Assembly

#### <Standard>

##### SYJ500-3-2A

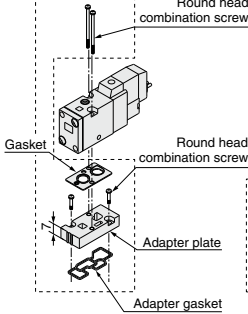

**Applicable manifold base**

- Type 10-SS5YJ5-20
- Type 10-SS5YJ5-20P

##### SYJ500-3-1A

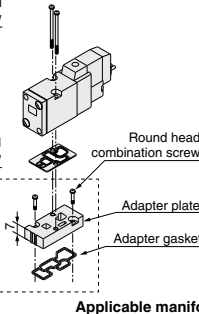

**Applicable manifold base**

- Type 10-SS5YJ5-40
- Type 10-SS5YJ5-41
- Type 10-SS5YJ5-42
- Type 10-SS5YJ5-43
- Type 10-SS5YJ5-41P
- Type 10-SS5YJ5-42P
- Type 10-SS5YJ5-43P

#### <CE-compliant>

##### SYJ500-3-1A-1-Q

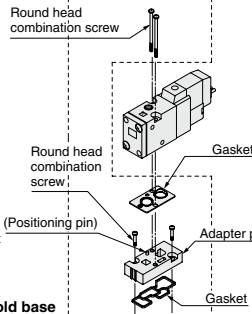

**Applicable manifold base**

- Type 10-SS5YJ5-20-Q
- Type 10-SS5YJ5-20P-Q

##### SYJ500-3-1A-2-Q

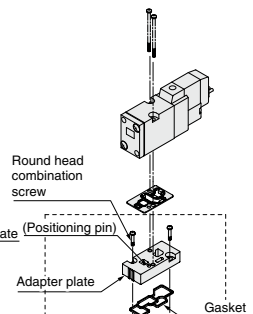

**Applicable manifold base**

- Type 10-SS5YJ5-40-Q
- Type 10-SS5YJ5-41-Q
- Type 10-SS5YJ5-42-Q
- Type 10-SS5YJ5-43-Q
- Type 10-SS5YJ5-41P-Q
- Type 10-SS5YJ5-43P-Q

### Individual EXH Spacer Assembly

#### SYJ5000-17-3 □ A

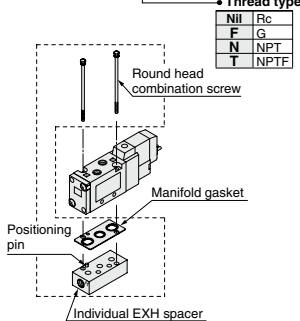

**Applicable manifold base**

- 10-SS5YJ5-20(-Q)
- 10-SS5YJ5-20P(-Q)

#### SYJ5000-17-4 □ A

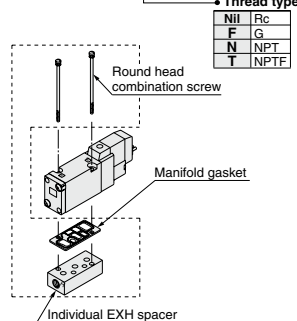

**Applicable manifold base**

- 10-SS5YJ5-40(-Q)
- 10-SS5YJ5-41(-Q)
- 10-SS5YJ5-42(-Q)
- 10-SS5YJ5-43(-Q)
- 10-SS5YJ5-41P(-Q)
- 10-SS5YJ5-43P(-Q)

### Individual SUP Spacer Assembly

#### SYJ5000-16-2 □ A(-Q)

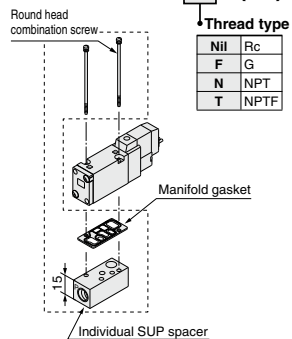

**Applicable manifold base**

- Type 10-SS5YJ5-41(-Q)
- Type 10-SS5YJ5-42(-Q)
- Type 10-SS5YJ5-43(-Q)
- Type 10-SS5YJ5-41P(-Q)
- Type 10-SS5YJ5-43P(-Q)

### ⚠ Caution

Mounting screw tightening torque

M2.5: 0.45 N·m

Use caution to the assembly orientation for solenoid valves, gasket, and optional parts.

**Type 20: Top Ported/10-SS5YJ5-20- Stations -00□**

\* [ ] : AC

**Grommet (G)**

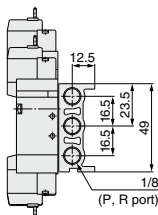
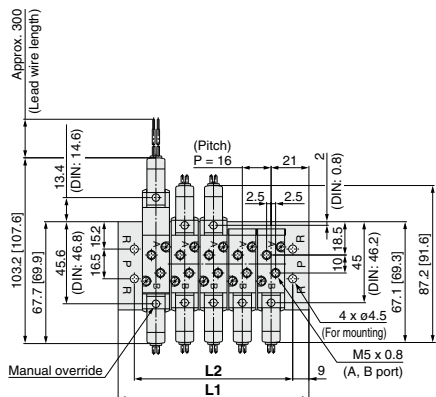

**For C4, N3, C6, N7  
(Built-in One-touch fitting)**

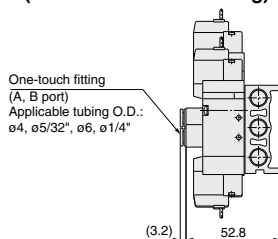
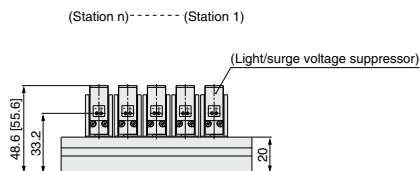

**L plug connector (L)**

**M plug connector (M)**

**DIN terminal (D, Y)**

**M8 connector (WO)**

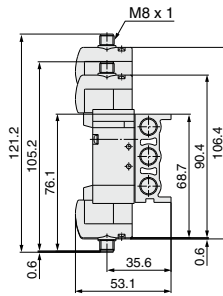
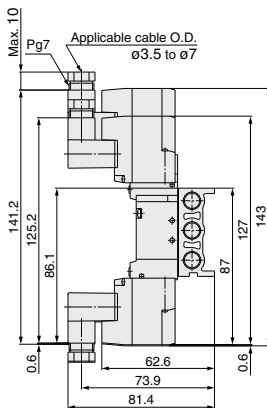
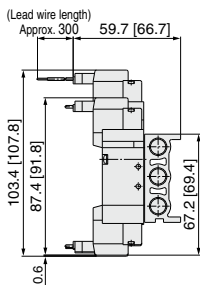
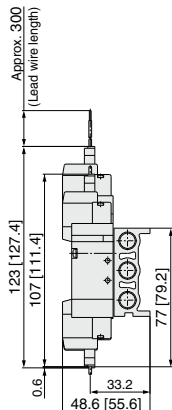

\* Refer to page 375 for dimensions with connector cable.

Station	Station 2	3	4	5	6	7	8	9	10	11	12	13	14	15	16	17	18	19	Station 20
L1	58	74	90	106	122	138	154	170	186	202	218	234	250	266	282	298	314	330	346
L2	40	56	72	88	104	120	136	152	168	184	200	216	232	248	264	280	296	312	328

**Type 40: Bottom Ported/10-SS5YJ5-40-Stations-M5**

\* [ ] : AC

**Grommet (G)**

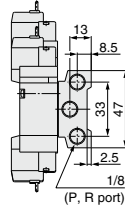
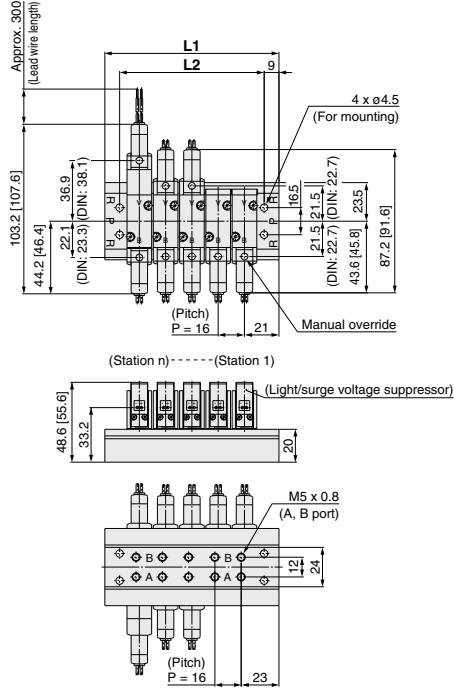

**Built-in throttle valve**

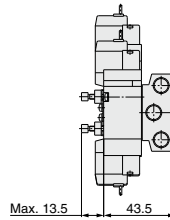

**L plug connector (L)**

**M plug connector (M)**

**DIN terminal (D, Y)**

**M8 connector (WO)**

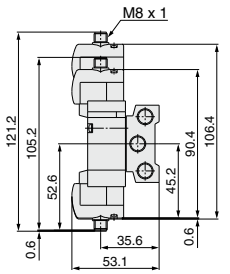
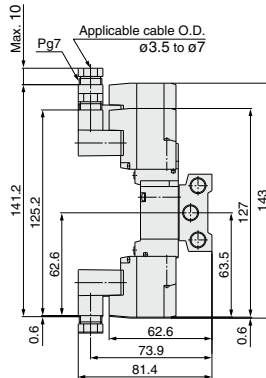
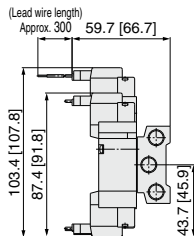
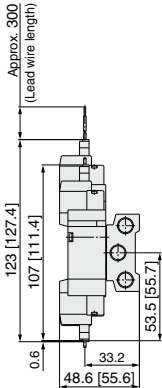

\* Refer to page 375 for dimensions with connector cable.

Station	Station 2	3	4	5	6	7	8	9	10	11	12	13	14	15	16	17	18	19	Station 20
L1	58	74	90	106	122	138	154	170	186	202	218	234	250	266	282	298	314	330	346
L2	40	56	72	88	104	120	136	152	168	184	200	216	232	248	264	280	296	312	328

Directional Control Valves

Air Cylinders

Rotary Actuators

Air Grippers

Air Preparation Equipment

Modular F. R.

Pressure Control Equipment

Fittings & Tubing

Flow Control Equipment

Pressure Switches/ Pressure Sensors

**Type 41: Side Ported/10-SS5YJ5-41- Stations -M5**

\* [ ]: AC

**Grommet (G)**

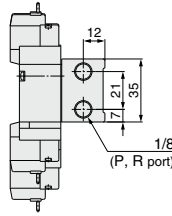
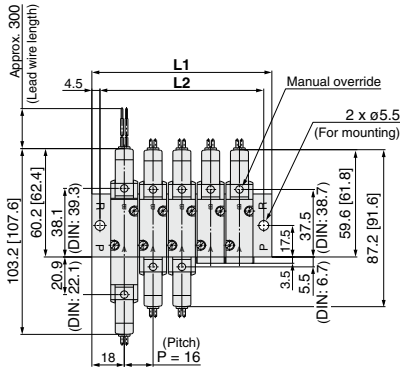

(Station 1)----- (Station n)

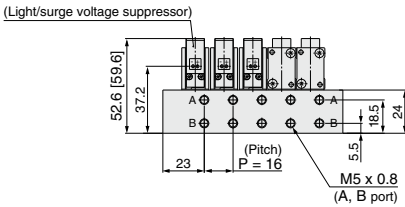

**Built-in throttle valve**

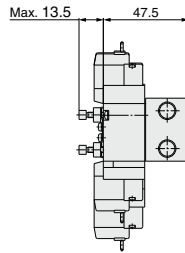

**L plug connector (L)**

**M plug connector (M)**

**DIN terminal (D, Y)**

**M8 connector (WO)**

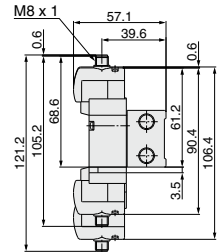
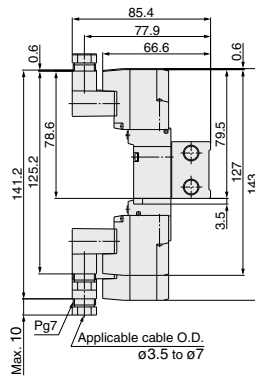
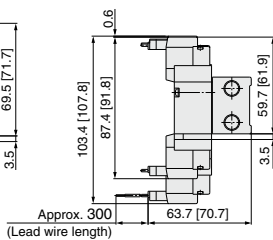
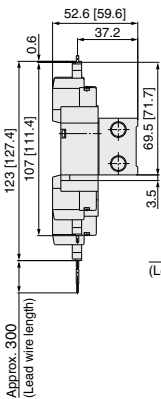

\* Refer to page 375 for dimensions with connector cable.

Station	Station 2	3	4	5	6	7	8	9	10	11	12	13	14	15	16	17	18	19	Station 20
L1	52	68	84	100	116	132	148	164	180	196	212	228	244	260	276	292	308	324	340
L2	43	59	75	91	107	123	139	155	171	187	203	219	235	251	267	283	299	315	331

**Type 42: Side Ported/10-SS5YJ5-42-Stations-01, C6  
N7 □**

\* [ ] : AC

**Grommet (G)  
For 01 □**

**For C6 □ (Built-in One-touch fitting)  
N7 □**

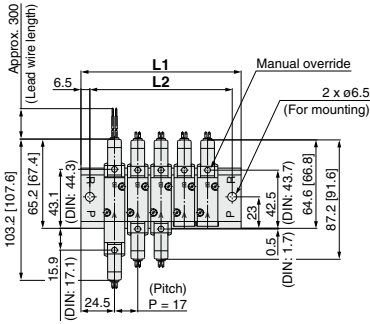

(Station 1) ---- (Station n)

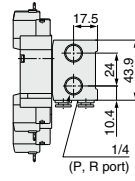
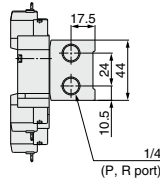

**(Light/surge voltage suppressor)**

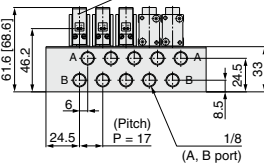

**Built-in throttle valve**

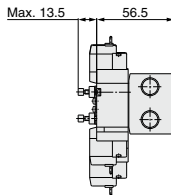

**(Station 1) ---- (Station n)  
(Light/surge voltage suppressor)**

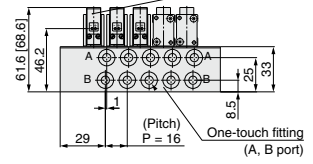

Applicable tubing O.D.: ø6, ø1/4"

\* Other dimensions are the same as the grommet type.

**L plug connector (L)**

**M plug connector (M)**

**DIN terminal (D, Y)**

**M8 connector (WO)**

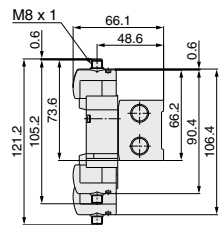
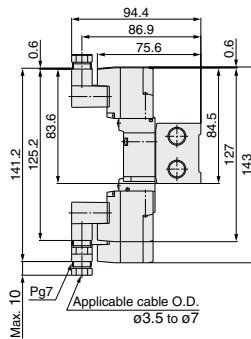
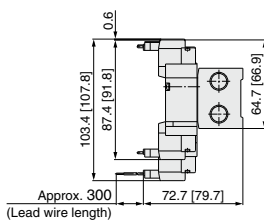
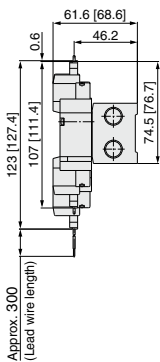

\* Refer to page 375 for dimensions with connector cable.

A, B port size	Station	Station 2	3	4	5	6	7	8	9	10	11	12	13	14	15	16	17	18	19	Station 20
For 1/8	L1	66	83	100	117	134	151	168	185	202	219	236	253	270	287	304	321	338	355	372
	L2	53	70	87	104	121	138	155	172	189	206	223	240	257	274	291	308	325	342	359
For C6/N7	L1	65	81	97	113	129	145	161	177	193	209	225	241	257	273	289	305	321	337	353
	L2	52	68	84	100	116	132	148	164	180	196	212	228	244	260	276	292	308	324	340

Directional Control Valves  
Air Cylinders  
Rotary Actuators  
Air Grippers  
Air Preparation Equipment  
Modular F. R.  
Pressure Control Equipment  
Fittings & Tubing  
Flow Control Equipment  
Pressure Switches/ Pressure Sensors



**Type 43: Side Ported/10-SS5YJ3-43-Stations** - C4  
N3

\* [ ] : AC

**Grommet (G)**

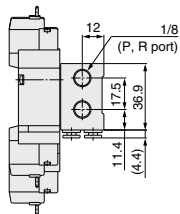
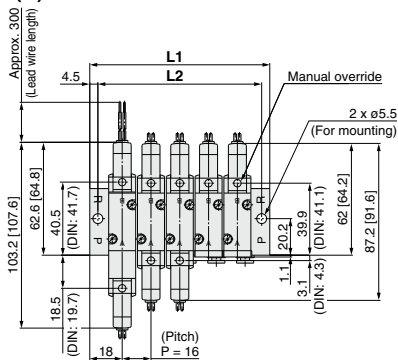

**Built-in throttle valve**

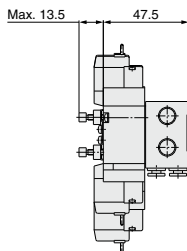
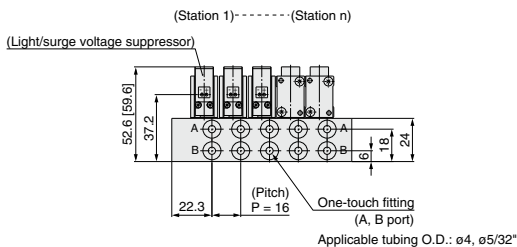

**L plug connector (L)**

**M plug connector (M)**

**DIN terminal (D, Y)**

**M8 connector (WO)**

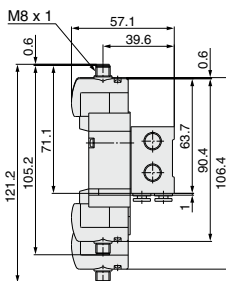
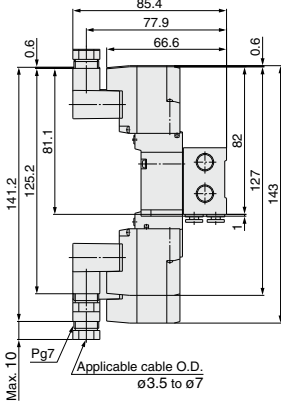
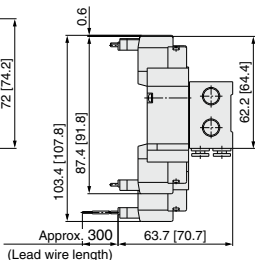
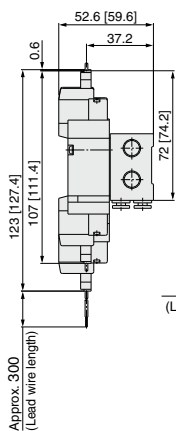

\* Refer to page 375 for dimensions with connector cable.

Station	Station 2	3	4	5	6	7	8	9	10	11	12	13	14	15	16	17	18	19	Station 20
L1	52	68	84	100	116	132	148	164	180	196	212	228	244	260	276	292	308	324	340
L2	43	59	75	91	107	123	139	155	171	187	203	219	235	251	267	283	299	315	331

**Flat Ribbon Cable Manifold**

\* [ ] : AC

**10-SS5YJ5-20P- Stations -00**

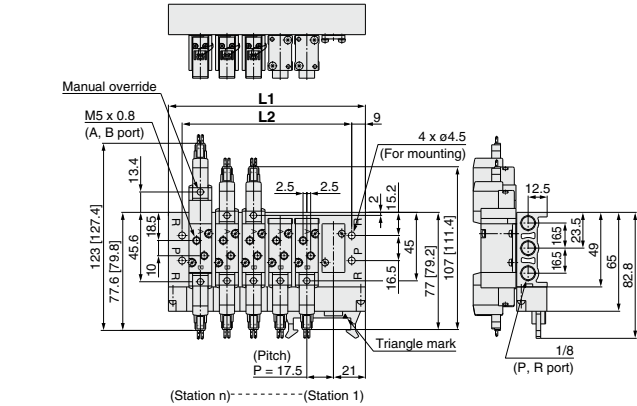

For C4, N3  
C6, N7 (Built-in One-touch fitting)

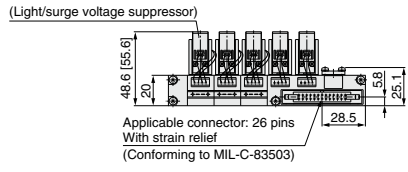
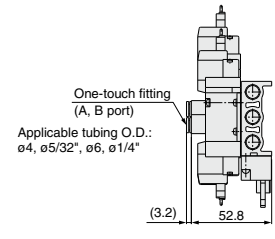

Station	Station 3	4	5	6	7	8	9	10	11	Station 12
<b>L1</b>	77	94.5	112	129.5	147	164.5	182	199.5	217	234.5
<b>L2</b>	59	76.5	94	111.5	129	146.5	164	181.5	199	216.5

**10-SS5YJ5-41P- Stations -M5**

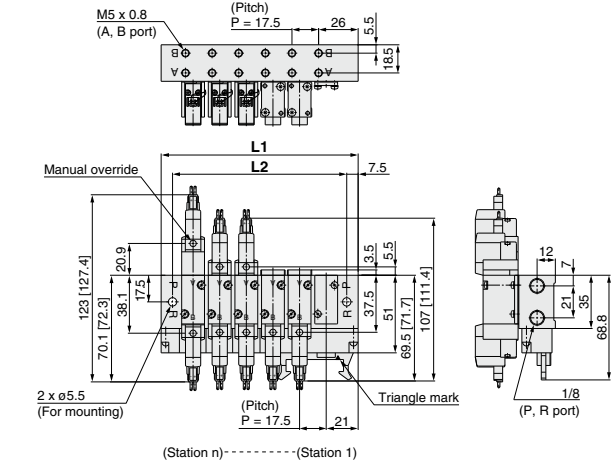

**Built-in throttle valve**

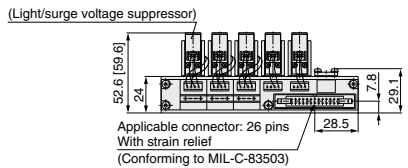
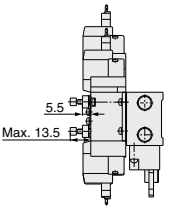

Station	Station 3	4	5	6	7	8	9	10	11	Station 12
<b>L1</b>	77	94.5	112	129.5	147	164.5	182	199.5	217	234.5
<b>L2</b>	62	79.5	97	114.5	132	149.5	167	184.5	202	219.5

Directional Control Valves  
 Air Cylinders  
 Rotary Actuators  
 Air Grippers  
 Air Preparation Equipment  
 Modular F. R.  
 Pressure Control Equipment  
 Fittings & Tubing  
 Flow Control Equipment  
 Pressure Switches/ Pressure Sensors

**Flat Ribbon Cable Manifold**

\* [ ]: AC

**10-SS5YJ5-43P- Stations - C4 N3**

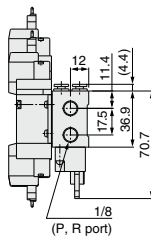
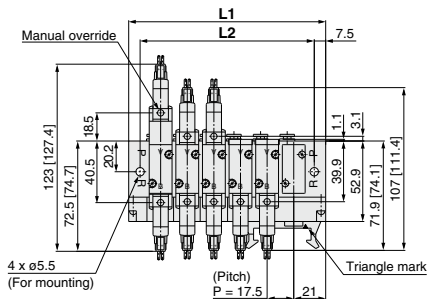
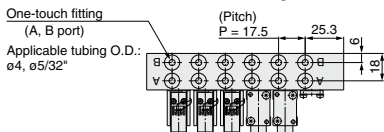

**Built-in throttle valve**

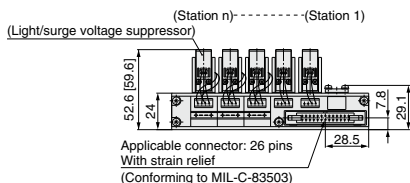
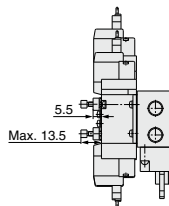

Station	Station 3	4	5	6	7	8	9	10	11	Station 12
L1	77	94.5	112	129.5	147	164.5	182	199.5	217	234.5
L2	62	79.5	97	114.5	132	149.5	167	184.5	202	219.5

**EX510 Gateway-type Serial Transmission System**

10-SS5YJ5-20SA□ - Stations □ - □

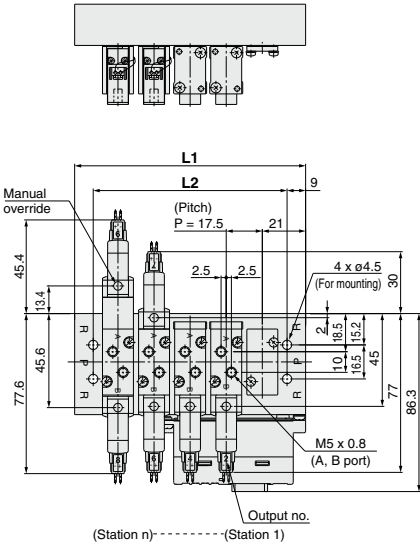

For C4, N3  
C6, N7 (Built-in One-touch fitting)

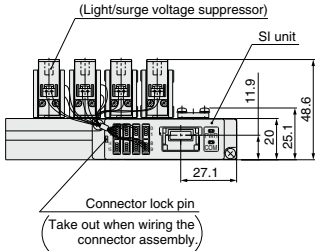
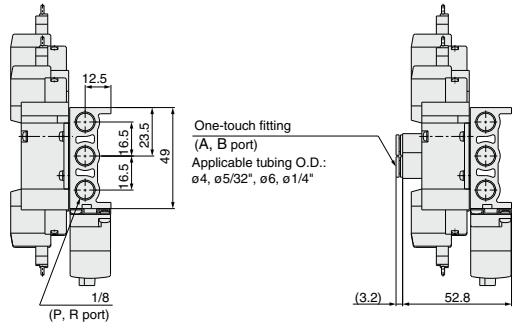

Station	Station 3	4	5	6	7	8	9	10	11	12	13	14	15	Station 16
L1	77	94.5	112	129.5	147	164.5	182	199.5	217	234.5	252	269.5	287	304.5
L2	59	76.5	94	111.5	129	146.5	164	181.5	199	216.5	234	251.5	269	286.5

Directional Control Valves

Air Cylinders

Rotary Actuators

Air Grippers

Air Preparation Equipment

Modular F. R.

Pressure Control Equipment

Fittings & Tubing

Flow Control Equipment

Pressure Switches/ Pressure Sensors

**EX510 Gateway-type Serial Transmission System**

**10-SS5YJ5-41SA□ - Stations -M5□**

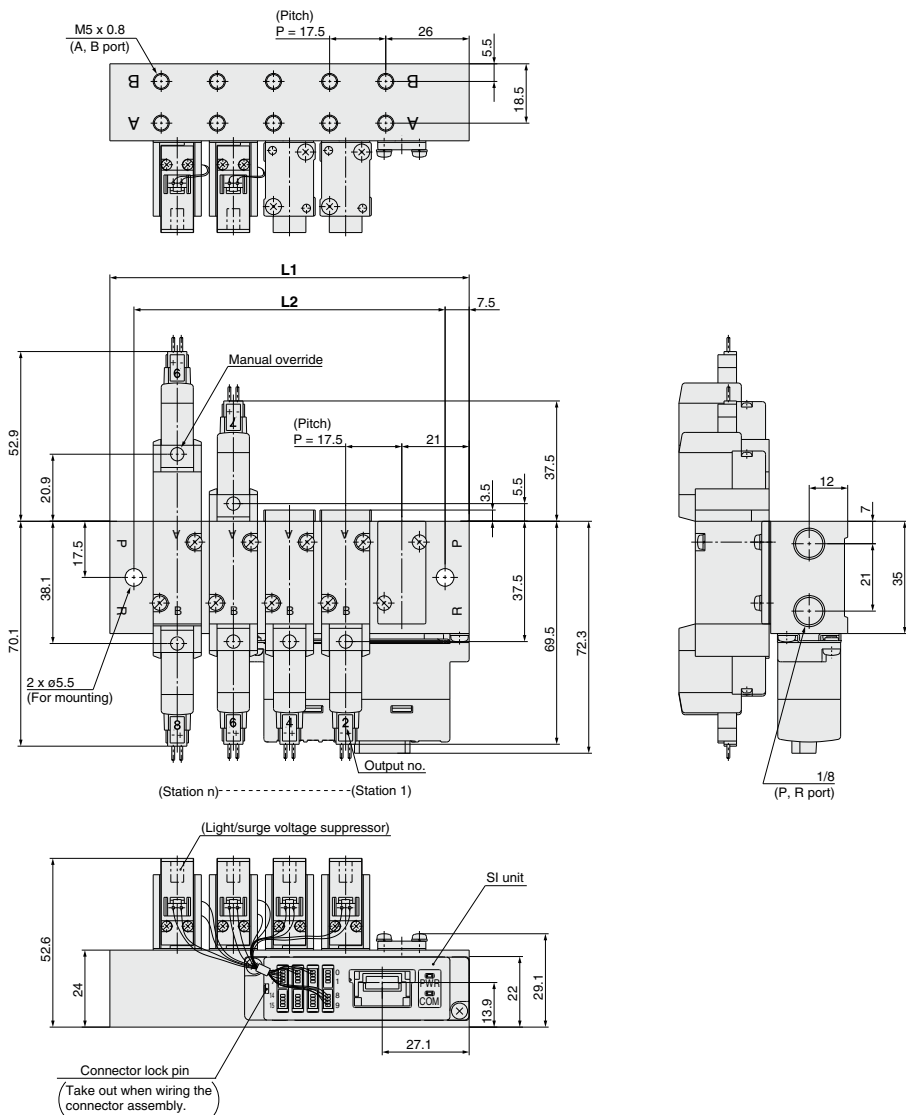

Station	Station 3	4	5	6	7	8	9	10	11	12	13	14	15	Station 16
L1	77	94.5	112	129.5	147	164.5	182	199.5	217	234.5	252	269.5	287	304.5
L2	62	79.5	97	114.5	132	149.5	167	184.5	202	219.5	237	254.5	272	289.5

EX510 Gateway-type Serial Transmission System

10-SS5YJ-42SA□-Stations-01□

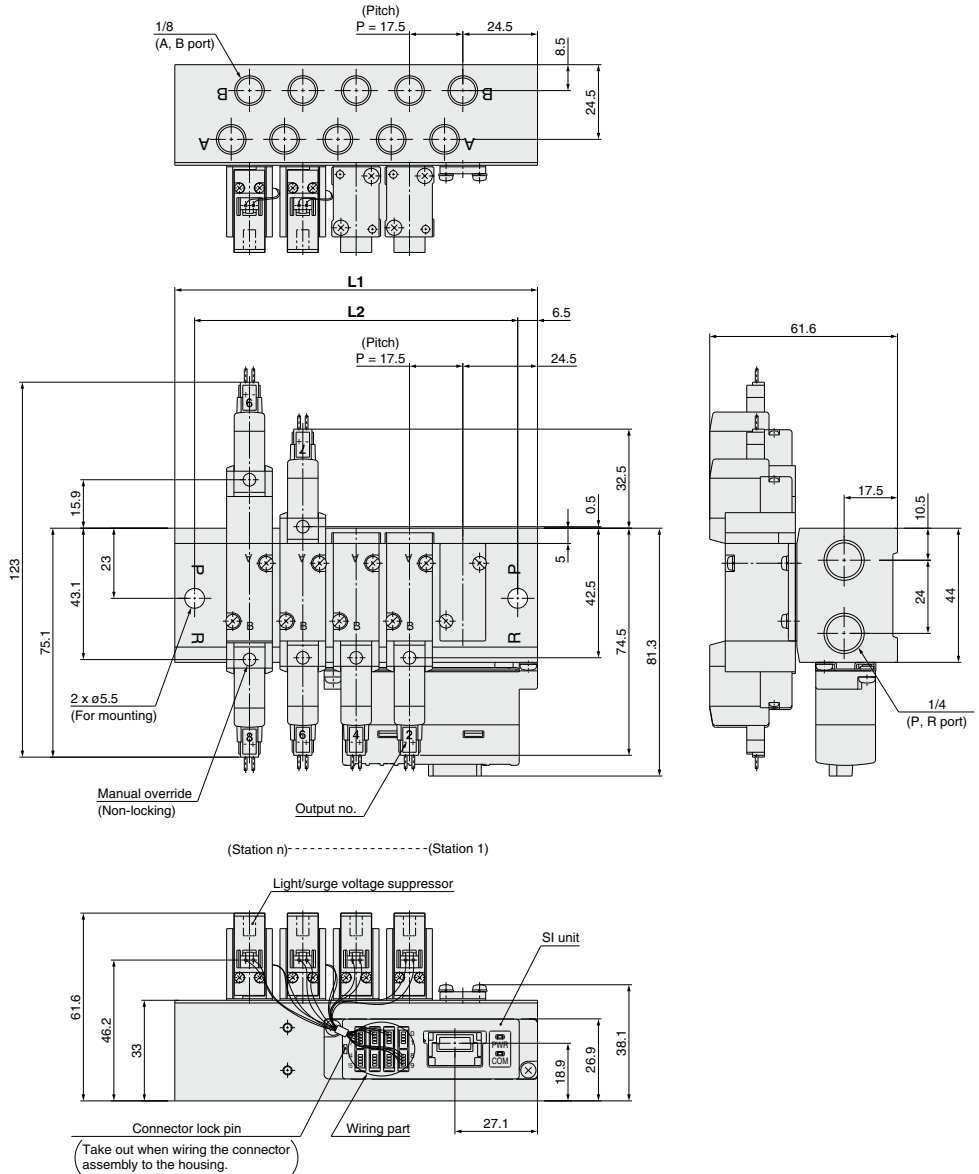

Station	Station 4	5	6	7	8	9	10	11	12	13	14	15	Station 16
L1	101.5	119	136.5	154	171.5	189	206.5	224	241.5	259	276.5	294	311.5
L2	88.5	106	123.5	141	158.5	176	193.5	211	228.5	246	263.5	281	298.5

Directional Control Valves

Air Cylinders

Rotary Actuators

Air Grippers

Air Preparation Equipment

Modular F. R.

Pressure Control Equipment

Fittings & Tubing

Flow Control Equipment

Pressure Switches/ Pressure Sensors

**EX510 Gateway-type Serial Transmission System**

**10-SS5YJ5-43SA□ - Stations - C4□  
N3□**

One-touch fitting

(A, B port)

Applicable tubing O.D.:  $\phi 4, \phi 5/32"$

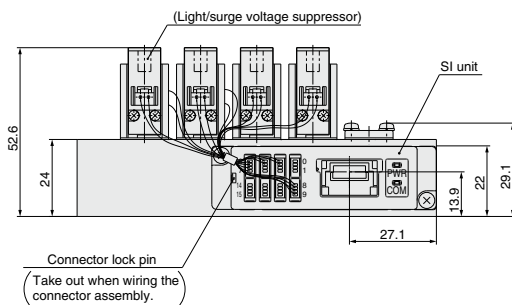
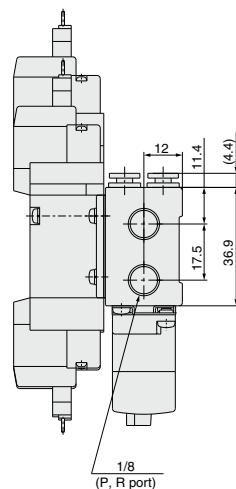
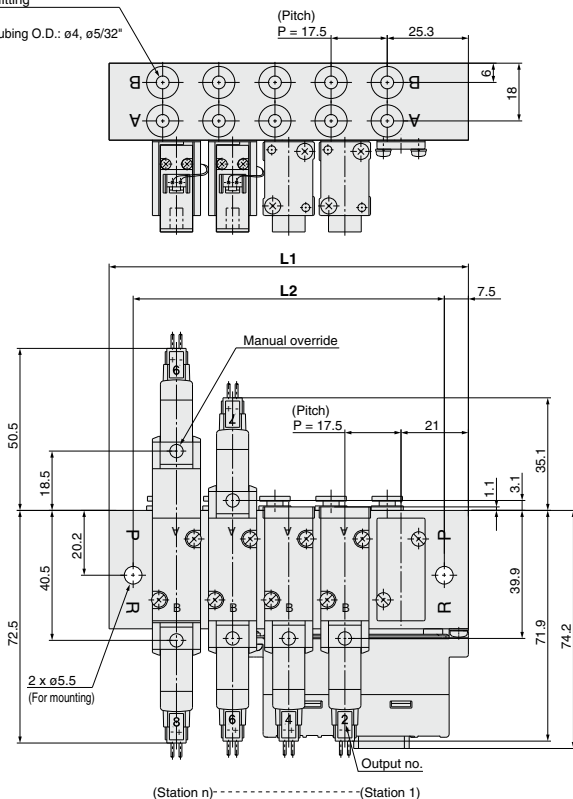

Station	Station 3	4	5	6	7	8	9	10	11	12	13	14	15	Station 16
<b>L1</b>	77	94.5	112	129.5	147	164.5	182	199.5	217	234.5	252	269.5	287	304.5
<b>L2</b>	62	79.5	97	114.5	132	149.5	167	184.5	202	219.5	237	254.5	272	289.5

# Series 10-SYJ7000 Rubber Seal 5 Port Solenoid Valve

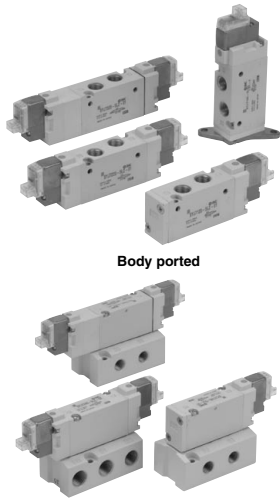

Body ported

Base mounted

## Symbol

### Body ported

2 position single

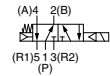

2 position double

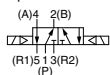

3 position closed center

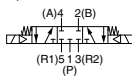

3 position exhaust center



3 position pressure center



### Base mounted

2 position single solenoid

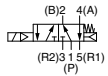

2 position double solenoid

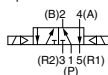

3 position closed center

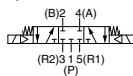

3 position exhaust center

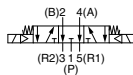

3 position pressure center

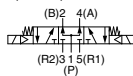

## Specifications

Fluid		Air
Operating pressure range (MPa)	2 position single	0.15 to 0.7
	2 position double	0.1 to 0.7
	3 position	0.15 to 0.7
Ambient and fluid temperature (°C)		-10 to 50 (No freezing)
Response time (ms) <sup>Note 1)</sup> (at 0.5 MPa)	2 position single, double	30 or less
	3 position	60 or less
Max. operating frequency (Hz)	2 position single, double	5
	3 position	3
Manual override (Manual operation)	Non-locking push type, Push-turn locking slotted type, Push-turn locking lever type	
Pilot exhaust method	Main/Pilot valve common exhaust	
Lubrication	Not required	
Mounting orientation	Unrestricted	
Impact/Vibration resistance (m/s <sup>2</sup> ) <sup>Note 2)</sup>	150/30	
Enclosure	Dust proof (* M8 connector conforms to IP65.)	

\* Based on IEC60529

Note 1) Based on dynamic performance test, JIS B 8375-1981. (Coil temperature: 20°C, at rated voltage, without surge suppressor)

Note 2) Impact resistance: No malfunction occurred when it was tested in the axial direction and at right angles to the main valve and armature in both energized and de-energized states once for each condition. (Default settings)

Vibration resistance: No malfunction occurred in a one-sweep test between 45 and 2000 Hz. Test was performed in both energized and de-energized states in the axial direction and at right angles to the main valve and armature. (Default settings)

## Solenoid Specifications

Electrical entry	Grommet (G), (H) L plug connector (L) M plug connector (M) DIN terminal (D), (Y) M8 connector (W)		
	G, H, L, M, W		D, Y
Coil rated voltage (V)	DC	24, 12, 6, 5, 3	
	AC 50/60 Hz	100, 110, 200, 220	
Allowable voltage fluctuation	±10% of rated voltage *		
Power consumption (W)	DC	Standard	0.35 (With light: 0.4 (DIN terminal with light: 0.45))
		With power saving circuit	0.1 (With light only) * [Starting 0.4, Holding 0.1]
Apparent power (VA) *	AC	100 V	0.78 (With light: 0.81)   0.78 (With light: 0.87)
		110 V	0.86 (With light: 0.89)   0.86 (With light: 0.97)
		[115 V]	[0.94 (With light: 0.97)]   [0.94 (With light: 1.07)]
		200 V	1.18 (With light: 1.22)   1.15 (With light: 1.30)
		220 V [230 V]	1.30 (With light: 1.34)   1.27 (With light: 1.46) [1.42 (With light: 1.46)]   [1.39 (With light: 1.60)]
Surge voltage suppressor	Diode (DIN terminal, Varistor when non-polar types)		
Indicator light	LED (Neon light when AC with DIN terminal)		

\* Common between 110 VAC and 115 VAC, and between 220 VAC and 230 VAC.

\* For 115 VAC and 230 VAC, the allowable voltage is -15% to +5% of rated voltage.

\* For details, refer to page 372.



**Made to Order**  
(For details, refer to page 369.)



### Flow Rate Characteristics/Weight

Valve model	Actuation type	Port size		Flow rate characteristics <sup>Note 1)</sup>						Weight (g) <sup>Note 2, 3)</sup>					
		1, 5, 3 (P, EA, EB)	4, 2 (A, B)	1 → 4/2 (P → A/B)			4/2 → 5/3 (A/B → EA/EB)			Grommet	L/M plug connector	DIN terminal	M8 connector		
		C [dm <sup>3</sup> /(s·bar)]	b	Cv	C [dm <sup>3</sup> /(s·bar)]	b	Cv								
Body ported	10-SYJ7□23-□-01	2 position	Single	1/8	1/8	2.2	0.36	0.58	2.4	0.34	0.63	108	110	157	118
			Double			1.8	0.37	0.45	2.0	0.35	0.49				
		3 position	Closed center			1.2	0.50	0.34	3.0 [1.3]	0.35 [0.52]	0.73 [0.39]				
			Exhaust center			3.0 [0.83]	0.37 [0.50]	0.78 [0.25]	1.8	0.37	0.45				
			Pressure center			1.6	0.33	0.4	2.2	0.32	0.53				
						1.4	0.27	0.35	1.9	0.33	0.49				
	10-SYJ7□23-□-06	2 position	Single	1/8	C6 (ø6 One-touch fitting)	1.1	0.37	0.27	2.5 [1.3]	0.32 [0.54]	0.61 [0.38]	119	121	163	129
			Double			1.8 [0.78]	0.36 [0.40]	0.45 [0.22]	1.6	0.30	0.39				
		3 position	Closed center			2.0	0.39	0.52	2.3	0.34	0.61				
			Exhaust center			1.7	0.35	0.42	2.0	0.29	0.49				
			Pressure center			1.2	0.38	0.33	2.6 [1.3]	0.35 [0.49]	0.67 [0.38]				
						1.9 [0.86]	0.57 [0.46]	0.59 [0.25]	1.7	0.39	0.42				
10-SYJ7□23-□-08	2 position	Single	1/8	C8 (ø8 One-touch fitting)	2.3	0.45	0.57	2.8	0.37	0.71	188 (108)	190 (110)	232 (152)	198 (118)	
		Double			1.9	0.36	0.48	2.1	0.46	0.57					
	3 position	Closed center			1.2	0.48	0.35	3.4 [1.3]	0.36 [0.57]	0.86 [0.41]					
		Exhaust center			3.3 [0.85]	0.43 [0.54]	0.78 [0.25]	2.1	0.45	0.56					
		Pressure center			2.3	0.41	0.61	2.9	0.35	0.74					
					1.9	0.46	0.50	2.2	0.44	0.60					
Base mounted	10-SYJ7□43-□-01	2 position	Single	1/8	1/8	2.3	0.45	0.57	2.8	0.37	0.71	165 (85) 178 (98)	166 (86) 180 (100)	187 (107) 222 (142)	170 (90) 188 (108)
			Double			1.9	0.36	0.48	2.1	0.46	0.57				
		3 position	Closed center			1.2	0.48	0.35	3.4 [1.3]	0.36 [0.57]	0.86 [0.41]				
			Exhaust center			3.3 [0.85]	0.43 [0.54]	0.78 [0.25]	2.1	0.45	0.56				
			Pressure center			2.3	0.41	0.61	2.9	0.35	0.74				
						1.9	0.46	0.50	2.2	0.44	0.60				
	10-SYJ7□43-□-02	2 position	Single	1/4	1/4	2.3	0.45	0.35	3.7 [1.4]	0.27 [0.56]	0.87 [0.43]	188 (108)	190 (110)	232 (152)	198 (118)
			Double			1.3	0.45	0.35	3.7 [1.4]	0.27 [0.56]	0.87 [0.43]				
		3 position	Closed center			3.6 [0.83]	0.23 [0.55]	0.84 [0.25]	2.1	0.47	0.58				
			Exhaust center												
			Pressure center												

Note 1 [ ]: denotes normal position. Exhaust center: 4/2 → 5/3, Pressure center: 1 → 4/2

Note 2 ( ): Without sub-plate.

Note 3) For DC voltages. For AC voltages, add 3 g to the weight of the single solenoid and 6 g to the weight of the double solenoid and 3 position types.

### Cylinder Speed Chart

Use as a guide for selection.

Please confirm the actual conditions with SMC Model Selection Software.

#### Body Ported

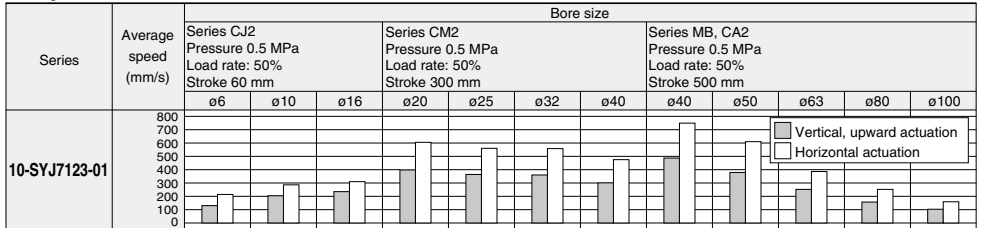

#### Base Mounted

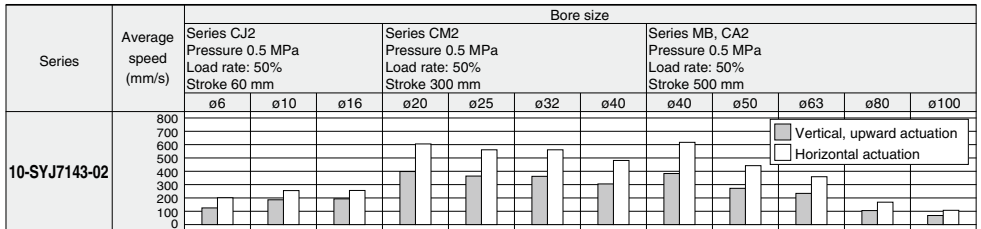

\* Cylinder is in extending. Speed controller is meter-out, which is directly connected with cylinder and its needle is fully opened.

\* Average speed of cylinder is obtained by dividing the full stroke time by the stroke.

\* Load factor: ((Load mass x 9.8)/Theoretical force) x 100%

### Conditions

	Body ported	Series CJ2	Series CM2	Series MB/CA2
Tubing diameter x Length		ø6 x 1 m		ø12 x 1 m
Speed controller		AS2302F-06	AS3302F-06	AS4002F-12
Silencer		AN110-01	AN20-02	

	Base mounted	Series CJ2	Series CM2	Series MB/CA2
Tubing diameter x Length		ø6 x 1 m		
Speed controller		AS1302F-06	AS3002F-06	
Silencer		AN110-01	AN20-02	AN3301F-06



## Construction

### 2 position single

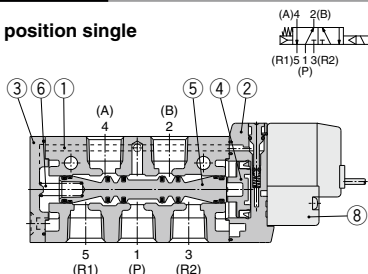

### 2 position double

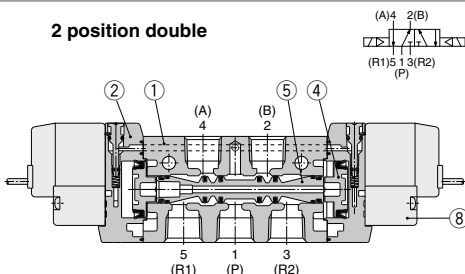

### 3 position closed center/exhaust center/pressure center

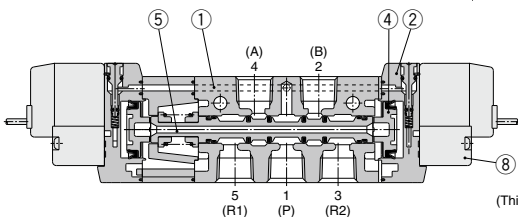
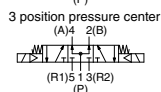
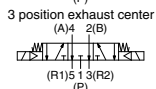
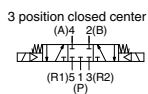

(This figure shows a closed center type.)

## Component Parts

No.	Description	Material	Note
1	<b>Body</b>	Aluminum die-casted	White
2	<b>Piston plate</b>	Resin	White
3	<b>End cover</b>	Aluminum die-casted	White
4	<b>Piston</b>	Resin	—
5	<b>Spool valve assembly</b>	Aluminum, H-NBR	—
6	<b>Spool spring</b>	Stainless steel	—

## Replacement Parts

No.	Description	Part no.	Note
7	<b>Sub-plate</b> <sup>(Note)</sup>	SYJ7000-22-1(-Q) SYJ7000-22-2(-Q)	1/8 1/4 Aluminum die-casted
8	<b>Pilot valve</b>	V111(T)-□□□	—

Note) Add suffix "-Q" for the CE-compliant product.

## How to Order Pilot Valve Assembly

V111 - 5 G

### Coil type

<b>Nii</b>	Standard
<b>T</b>	With power saving circuit (24, 12 VDC only)

\* Power saving circuit is not available for W□ type.

### Rated voltage

<b>5</b>	24 VDC
<b>6</b>	12 VDC
<b>V</b>	6 VDC
<b>S</b>	5 VDC
<b>R</b>	3 VDC
<b>1</b>	100 VAC 50/60 Hz
<b>2</b>	200 VAC 50/60 Hz
<b>3</b>	110 VAC 50/60 Hz [115 VAC 50/60 Hz]
<b>4</b>	220 VAC 50/60 Hz [230 VAC 50/60 Hz]

\* For type W□, only DC voltage is available.  
\* CE-compliant: For DC only.

### Light/Surge voltage suppressor

<b>Nii</b>	Without light/surge voltage suppressor
<b>S</b>	With surge voltage suppressor
<b>Z</b>	With light/surge voltage suppressor
<b>R</b>	With surge voltage suppressor (Non-polar type)
<b>U</b>	With light/surge voltage suppressor (Non-polar type)

\* For AC voltage valves there is no "S" option. It is already built into the rectifier circuit.  
\* For type R and U, only DC voltage is available.  
\* Power saving circuit is only available for the "Z" type.

### Electrical entry

<b>G</b>	Grommet, 300 mm lead wire
<b>H</b>	Grommet, 600 mm lead wire
<b>L</b>	L plug
<b>LN</b>	connector
<b>LO</b>	connector
<b>L</b>	With lead wire
<b>LN</b>	Without lead wire
<b>LO</b>	Without connector
<b>M</b>	M plug
<b>MN</b>	connector
<b>MO</b>	connector
<b>WO</b>	M8
<b>W□</b>	connector
	With connector cable <sup>(Note 1)</sup>

\* For connector cable of M8 connector, refer to page 374.

V115 - 5 D

### Rated voltage

<b>5</b>	24 VDC
<b>6</b>	12 VDC
<b>1</b>	100 VAC 50/60 Hz
<b>2</b>	200 VAC 50/60 Hz
<b>3</b>	110 VAC 50/60 Hz [115 VAC 50/60 Hz]
<b>4</b>	220 VAC 50/60 Hz [230 VAC 50/60 Hz]

### Light/Surge voltage suppressor

<b>Nii</b>	Without light/surge voltage suppressor
<b>S</b>	With surge voltage suppressor (Non-polar type)
<b>Z</b>	With light/surge voltage suppressor (Non-polar type)

\* DOZ is not available.  
\* For AC voltage valves there is no "S" option. It is already built into the rectifier circuit.

### Electrical entry

<b>D</b>	DIN terminal	With connector
<b>DO</b>	(Type D)	Without connector
<b>Y</b>	DIN terminal	With connector
<b>YO</b>	(Type Y)	Without connector

Note) Do not replace V111 (G, H, L, M, W) with V115 (DIN terminal) and vice versa when replacing pilot valve assembly only.

Note 1) Enter the cable length symbols in □. Please be sure to fill in the blank referring to page 374.

Note) Since V111 and V115 are CE-compliant as standard, the suffix "-Q" is not necessary.

**2 Position Single**

**Grommet (G), (H): 10-SYJ7123-□□□□-01□**

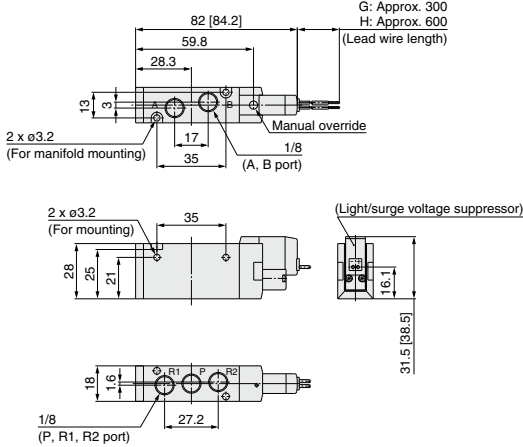

**With bracket:  
10-SYJ7123-□□□□-01□-F**

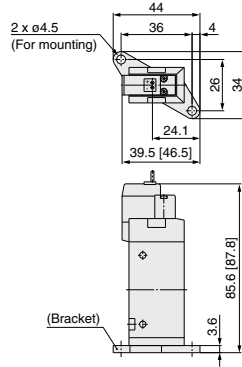

**Built-in One-touch fitting:  
10-SYJ7123-□□□□-C6, N7 □□ (-F)**

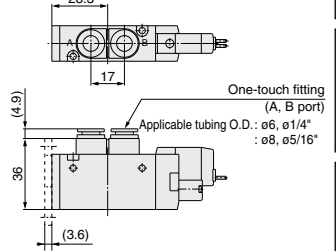

**L plug connector (L):  
10-SYJ7123-□□□□-01□ (-F)**

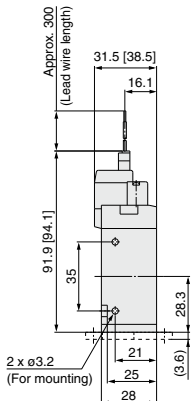

**M plug connector (M):  
10-SYJ7123-□□□□-01□ (-F)**

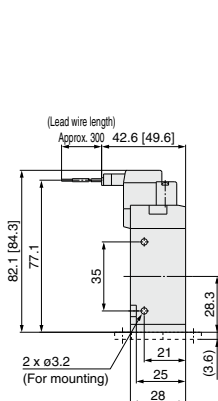

**DIN terminal (D, Y):  
10-SYJ7123-□□□□-01□ (-F)**

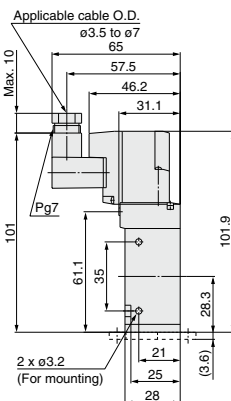

**M8 connector (WO):  
10-SYJ7123-□□□□-01□ (-F)**

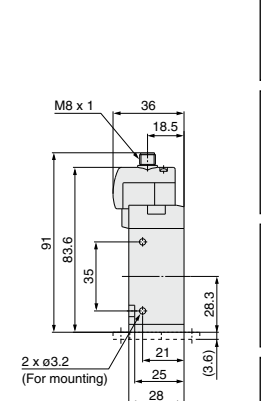

\* Refer to page 375 for dimensions with connector cable.

Directional Control Valves

Air Cylinders

Rotary Actuators

Air Grippers

Air Preparation Equipment

Modular F. R.

Pressure Control Equipment

Fittings & Tubing

Flow Control Equipment

Pressure Switches/ Pressure Sensors

**2 Position Double**

\* [ ]: AC

**Grommet (G), (H): 10-SYJ7223-□□□□-01□**

**Built-in One-touch fitting:**  
 C8, N7  
 10-SYJ7223-□□□□-01□

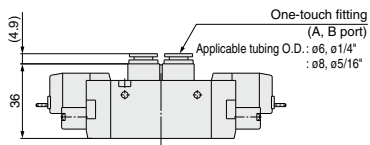
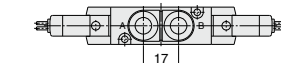
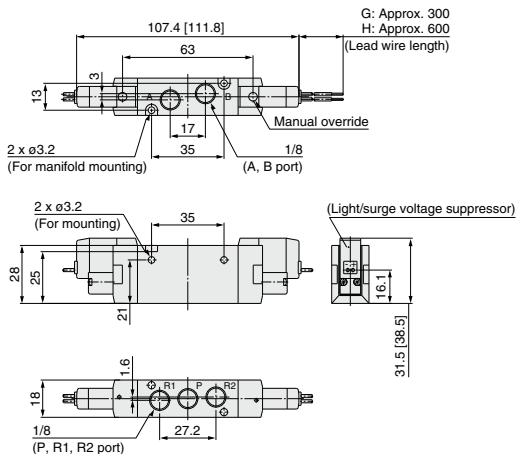

**L plug connector (L):**  
 10-SYJ7223-□□□□-01□

**M plug connector (M):**  
 10-SYJ7223-□□□□-01□

**DIN terminal (D, Y):**  
 10-SYJ7223-□□□□-01□

**M8 connector (WO):**  
 10-SYJ7223-□□□□-01□

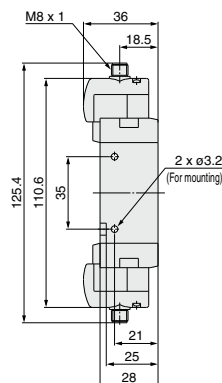
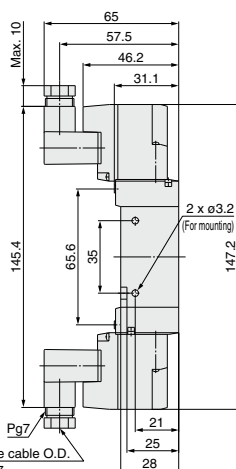
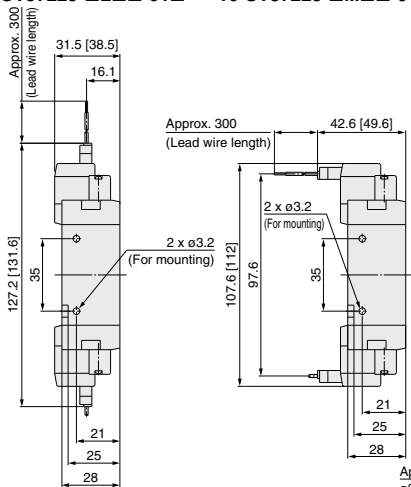

\* Refer to page 375 for dimensions with connector cable.

**3 Position Closed Center/Exhaust Center/Pressure Center**

\* [ ]: AC

**Grommet (G), (H):** 10-SYJ7<sup>3</sup>/<sub>5</sub>23-□<sup>G</sup>/<sub>H</sub>□□-01□

**Built-in One-touch fitting:**  
10-SYJ7<sup>3</sup>/<sub>5</sub>23-□<sup>G</sup>□□-□<sup>C6, N7</sup>/<sub>C8, N9</sub>□

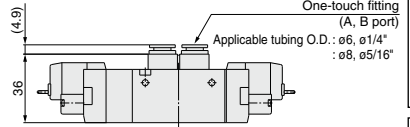
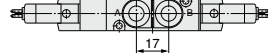
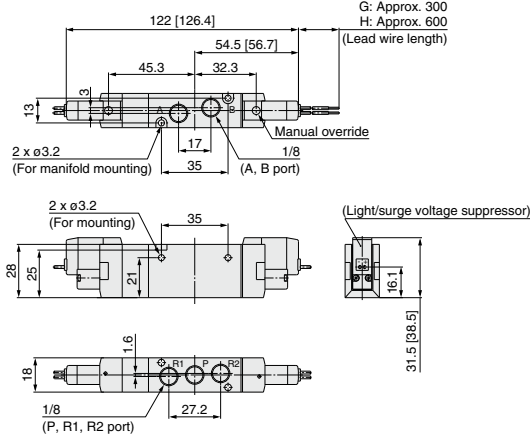

**L plug connector (L):**  
10-SYJ7<sup>3</sup>/<sub>5</sub>23-□<sup>L</sup>□□-01□

**M plug connector (M):**  
10-SYJ7<sup>3</sup>/<sub>5</sub>23-□<sup>M</sup>□□-01□

**DIN terminal (D, Y):**  
10-SYJ7<sup>3</sup>/<sub>5</sub>23-□<sup>D</sup>/<sub>Y</sub>□□-01□

**M8 connector (WO):**  
10-SYJ7<sup>3</sup>/<sub>5</sub>23-□<sup>WO</sup>□□-01□

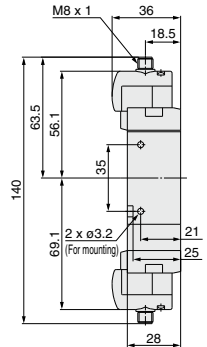
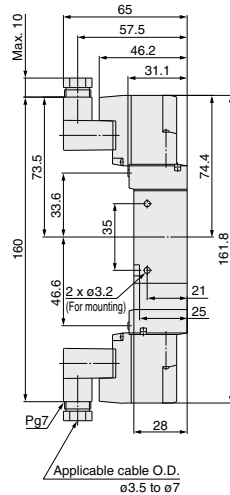
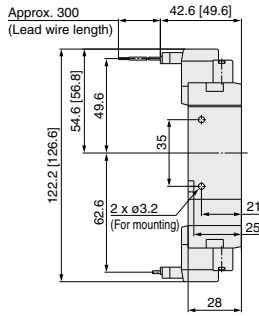
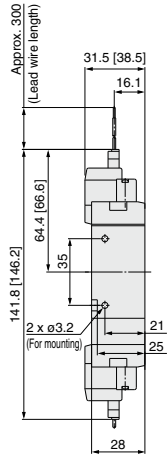

\* Refer to page 375 for dimensions with connector cable.

## 2 Position Single

\* [ ]: AC

Grommet (G), (H): 10-SYJ7143-□□□□-01□□

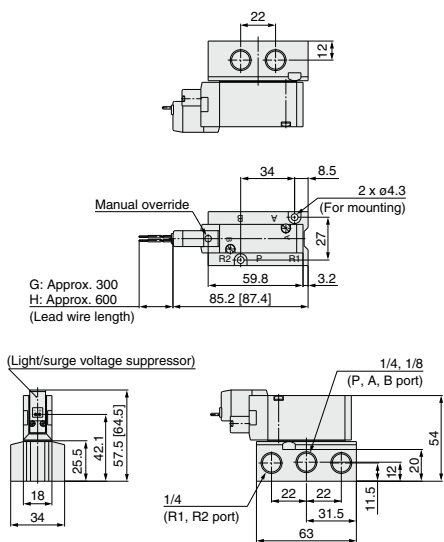

**L plug connector (L):**  
10-SYJ7143-□□□□-01□□

**M plug connector (M):**  
10-SYJ7143-□□□□-01□□

**DIN terminal (D, Y):**  
10-SYJ7143-□□□□-01□□

**M8 connector (WO):**  
10-SYJ7143-□□□□-01□□

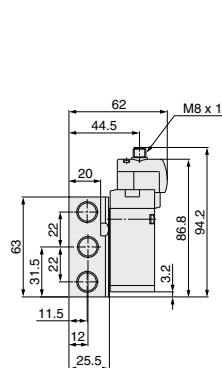
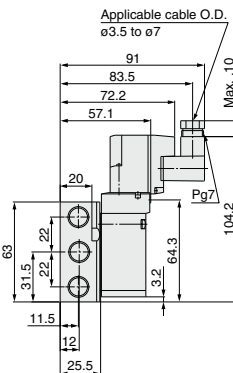
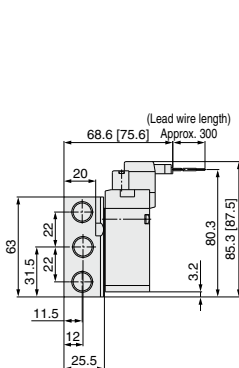
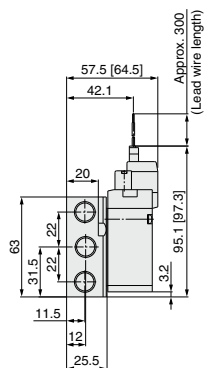

\* Refer to page 375 for dimensions with connector cable.

**2 Position Double**

\* [ ]: AC

Grommet (G), (H): 10-SYJ7243-□□□□-01□□

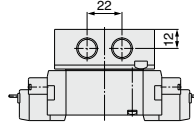

G: Approx. 300  
H: Approx. 600  
(Lead wire length)

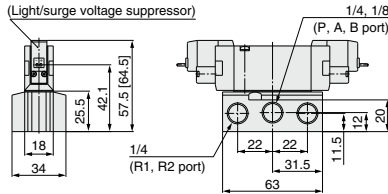
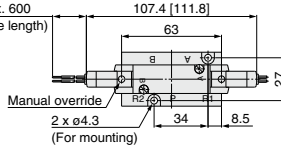

**L plug connector (L):**  
10-SYJ7243-□□□□-01□□

**M plug connector (M):**  
10-SYJ7243-□□□□-01□□

**DIN terminal (D, Y):**  
10-SYJ7243-□□□□-01□□

**M8 connector (WO):**  
10-SYJ7243-□□□□-01□□

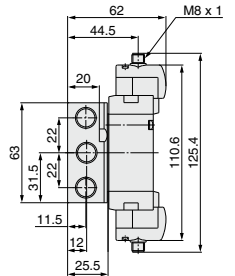
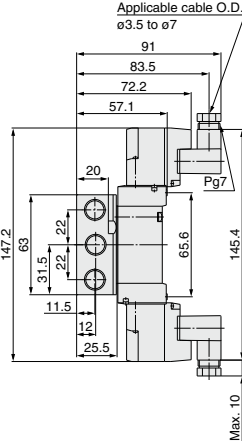
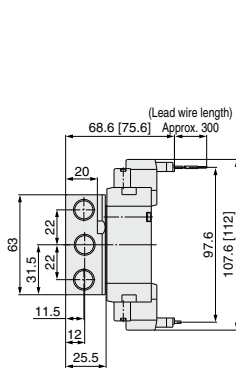
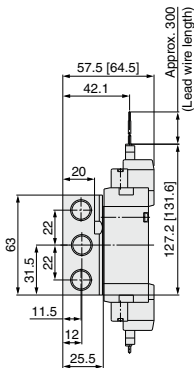

\* Refer to page 375 for dimensions with connector cable.



**3 Position Closed Center/Exhaust Center/Pressure Center**

\* [ ]: AC

Grommet (G), (H): 10-SYJ7<sup>3/4</sup>43-□□□□-01□□

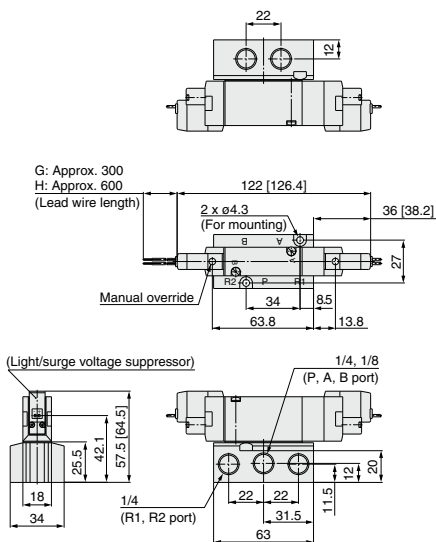

**L plug connector (L):**  
10-SYJ7<sup>3/4</sup>43-□□□□-01□□

**M plug connector (M):**  
10-SYJ7<sup>3/4</sup>43-□□□□-01□□

**DIN terminal (D, Y):**  
10-SYJ7<sup>3/4</sup>43-□□□□-01□□

**M8 connector (WO):**  
10-SYJ7<sup>3/4</sup>43-□□□□-01□□

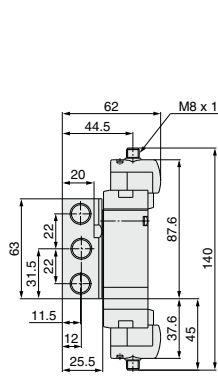
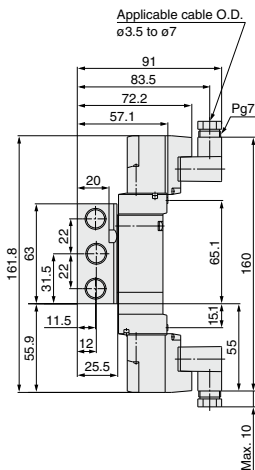
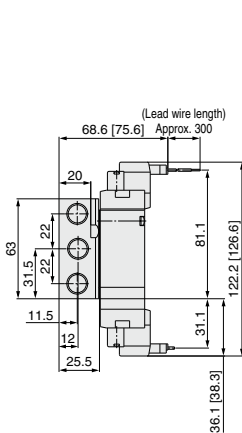
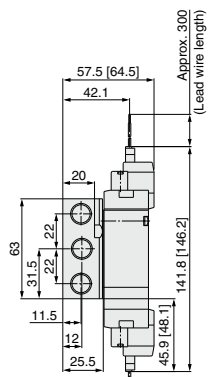

\* Refer to page 375 for dimensions with connector cable.

# Manifold Specifications



## Standard Manifold



### Manifold Specifications

Model		Type 20	Type 21	Type 40	Type 41	Type 42
<b>Manifold type</b>		Single base/B mount				
<b>P (SUP), R (EXH)</b>		Common SUP, Common EXH				
<b>Valve stations</b>		2 to 15 stations		2 to 20 stations		
<b>A, B port</b>	<b>Location</b>	Valve		Base	Base	
	<b>Direction</b>	Top		Bottom	Side	
<b>Porting specifications</b>	<b>P, R port</b>	1/8		1/4		
	<b>A, B port</b>	1/8 C6 (ø6 One-touch fitting) C8 (ø8 One-touch fitting)		1/8		C6 (ø6 One-touch fitting) C8 (ø8 One-touch fitting)

### Flow Rate Characteristics

Manifold		Port size		Flow rate characteristics						
				1 → 4/2 (P → A/B)			4/2 → 5/3 (A/B → R)			
		1(P), 5/3(R)	2(B), 4(A) port	C (dm <sup>3</sup> /(s·bar))	b	Cv	C (dm <sup>3</sup> /(s·bar))	b	Cv	
Body ported for internal pilot	Type 10-SS5YJ7-20	10-SYJ7□23	1/8	1/8	2.2	0.35	0.57	2.3	0.26	0.55
			1/8	C6	1.4	0.32	0.37	2.0	0.25	0.49
			1/8	C8	1.7	0.38	0.45	2.1	0.25	0.51
			1/4	1/8	2.1	0.36	0.55	2.3	0.26	0.54
			1/4	C6	1.4	0.32	0.36	2.1	0.24	0.50
			1/4	C8	1.8	0.37	0.50	2.1	0.20	0.50
Base mounted for internal pilot	Type 10-SS5YJ7-40 Type 10-SS5YJ7-41 Type 10-SS5YJ7-42-C6 Type 10-SS5YJ7-42-C8	10-SYJ7□43	1/4	1/8	2.1	0.28	0.51	2.5	0.23	0.59
			1/4	1/8	2.0	0.30	0.50	2.2	0.30	0.55
			1/4	C6	1.5	0.32	0.38	2.2	0.23	0.52
			1/4	C8	1.9	0.24	0.46	2.2	0.26	0.53

Note) The values are for individually operated 2 position type manifold bases.

### How to Order Manifold (Example)

Instruct by specifying the valves and blanking plate assembly to be mounted on the manifold along with the manifold base model no.

- Example: ● 10-SS5YJ7-20-03 ..... 1 pc. (Manifold base)  
 \* 10-SYJ7123-5G-01 ..... 2 pcs. (Valve)  
 \* SYJ7000-21-1A ..... 1 pc. (Blanking plate assembly)
- 10-SS5YJ7-41-03-01 ..... 1 pc. (Manifold base)  
 \* 10-SYJ7143-5LZ ..... 1 pc. (Valve)  
 \* 10-SYJ7243-5LZ ..... 1 pc. (Valve)  
 \* SYJ7000-21-1A ..... 1 pc. (Blanking plate assembly)

↳The asterisk denotes the symbol for assembly. Prefix it to the part no. of the solenoid valve, etc.

Directional Control Valves

Air Cylinders

Rotary Actuators

Air Grippers

Air Preparation Equipment

Modular F. R.

Pressure Control Equipment

Fittings & Tubing

Flow Control Equipment

Pressure Switches/ Pressure Sensors

Note) CE-compliant:  
For DC only.



## Flat Ribbon Cable Manifold

- Multiple valve wiring is simplified through the use of the flat ribbon cable connector.
- Clean appearance

For flat ribbon cables, each valve is wired on the print board of the manifold base to allow the external wiring to be piped all together with the 26 pin MIL connector.



## Flat Ribbon Cable Manifold Specifications

Model		Type 21P
Manifold type		Single base/B mount
P (SUP), R (EXH)		Common SUP, Common EXH
Valve stations		3 to 12 stations
A, B port location		Valve
Port size	P, R port	1/4
	A, B port	1/8, C6, C8
Applicable flat ribbon cable connector		Socket: 26 pin MIL type with strain relief (Conforming to MIL-C-83503)
Internal wiring		Common between +COM and -COM (Z type: +COM only).
Rated voltage <sup>Note 3)</sup>		24, 12 VDC, 100, 110 VAC

Note 1) The values are for individually operated 2 position type manifold bases.  
 Note 2) The withstand voltage specifications for the wiring unit section is JIS C 0704, Grade 1 or its equivalent.  
 Note 3) CE-compliant: For DC only.

## Flow Rate Characteristics

Manifold	Port size	Flow rate characteristics									
		1 → 4/2 (P → A/B)			4/2 → 5/3 (A/B → R)						
		C	b	Cv	C	b	Cv				
Body ported for internal pilot	Type 10-SS5YJ7-21P-01 Type 10-SS5YJ7-21P-C6 Type 10-SS5YJ7-21P-C8	1(P), 5/3(R) port	2(B), 4(A) port	1/4	1/8	2.1	0.36	0.55	2.3	0.26	0.54
				1/4	C6	1.4	0.32	0.36	2.1	0.24	0.50
				1/4	C8	1.8	0.37	0.50	2.1	0.20	0.50

Note) The values are for individually operated 2 position type manifold bases.

## How to Order Manifold (Example)

Instruct by specifying the valves, blanking plate assembly and connector assembly to be mounted on the manifold along with the manifold base model no.

Example:

- 10-SS5YJ7-21P-07 (-Q) ..... 1 pc. (Manifold base)
- \* 10-SYJ7123-5LOU-C8 (-Q) ... 3 pcs. (Valve)
- \* 10-SYJ7223-5LOU-C8 (-Q) ... 3 pcs. (Valve)
- \* SYJ7000-21-3A (-Q) ..... 1 pc. (Blanking plate assembly)
- \* SY3000-37-3A ..... 3 pcs. (Connector assembly)
- \* SY3000-37-4A ..... 3 pcs. (Connector assembly)

↳The asterisk denotes the symbol for assembly. Prefix it to the part no. of the solenoid valve, etc.

Note) Please indicate the connector assembly part no. below that connects the valve and the manifold.

## How to Order Valve

Note) CE-compliant:  
For DC only.

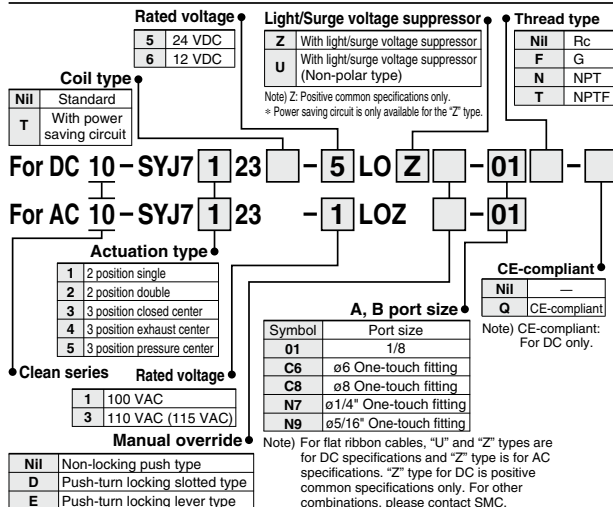

## Connector Assembly

### For 12, 24 VDC

Single solenoid	SY3000-37-3A
Double solenoid, 3 position type	SY3000-37-4A
Single solenoid	SY3000-37-3A
With individual EXH spacer assembly	
Double solenoid, 3 position type	SY3000-37-6A
With individual EXH spacer assembly	
With 3 port adapter plate	SY3000-37-3A

### For 100 VAC

Single solenoid	SY3000-37-32A
Double solenoid, 3 position type	SY3000-37-33A
Single solenoid	SY3000-37-15A
With individual EXH spacer assembly	
Double solenoid, 3 position type	SY3000-37-34A
With individual EXH spacer assembly	
With 3 port adapter plate	SY3000-37-32A

### For 110 VAC

Single solenoid	SY3000-37-35A
Double solenoid, 3 position type	SY3000-37-36A
Single solenoid	SY3000-37-19A
With individual EXH spacer assembly	
Double solenoid, 3 position type	SY3000-37-37A
With individual EXH spacer assembly	
With 3 port adapter plate	SY3000-37-35A

**EX510 Gateway-type Serial Transmission System**

**Manifold for EX510 Serial Wiring Specifications**

Model		Type 21SA	Type 41SA
Manifold type		Single base/B mount	
P (SUP), R (EXH)		Common SUP, Common EXH	
Valve stations		3 to 16 stations	
A, B port Porting specifications	Location	Valve	Base
	Direction	Top	Side
Port size	P, R port	1/4	
	A, B port	1/8, C6, C8 (ø6, ø8 One-touch fitting)	1/8
Rated voltage		24 VDC	

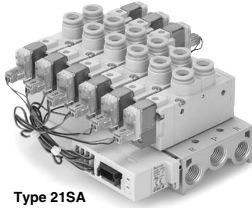

Type 21SA

**Flow Rate Characteristics**

Manifold			Port size		Flow rate characteristics					
					1 → 4/2 (P → A/B)			4/2 → 5/3 (A/B → R)		
			1(P), 5/3(R) port	2(B), 4(A) port	C (dm <sup>3</sup> /(s·bar))	b	Cv	C (dm <sup>3</sup> /(s·bar))	b	Cv
Body ported for internal pilot	Type 10-SS5YJ7-21SA	10-SYJ7□20	1/4	1/8	2.1	0.36	0.55	2.3	0.26	0.54
			1/4	C6	1.4	0.32	0.36	2.1	0.24	0.50
Base mounted for internal pilot	Type 10-SS5YJ7-41SA	10-SYJ7□40	1/4	C8	1.8	0.37	0.50	2.1	0.20	0.50
			1/4	1/8	2.0	0.30	0.50	2.2	0.30	0.55

**How to Order Manifold (Example)**

- 10-SS5YJ7-21SA-05 ..... 1 set (Type 21SA, 5-station manifold part no.)
- \* 10-SYJ7123-5LOU-01 ..... 3 sets (Single solenoid part no.)
- \* 10-SYJ7223-5LOU-01 ..... 2 sets (Double solenoid part no.)

↳ The asterisk denotes the symbol for assembly. Prefix it to the part no. of the solenoid valve, etc.

Add the valve and option part number under the manifold base part number.

When entry of part numbers becomes complicated, indicate by the manifold specification sheet. For a EX510 manifold, the length of the lead wire for a connector assembly depends on the number of stations. Therefore, the manifold assembly is shipped with the valves (including blanking plates) and connector assembly mounted on it, as the standard specification. Be sure to specify the part no. of the solenoid valves to be mounted.

Directional  
Control Valves

Air Cylinders

Rotary Actuators

Air Grippers

Air Preparation  
Equipment

Modular F. R.

Pressure Control  
Equipment

Fittings & Tubing

Flow Control  
Equipment

Pressure Switches/  
Pressure Sensors

# Series 10-SYJ7000

EX510 Gateway-type Serial Transmission System  
Body Ported Manifold



## How to Order Manifold

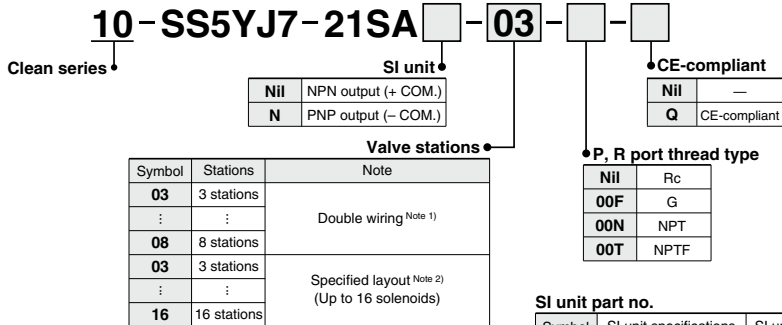

Includes the number of the blanking plate assemblies.  
 Note 1) Double wiring: Use of a single solenoid will result in an unused control signal. If this is not desired, order with a specified layout.  
 Note 2) Specified layout: Indicate wiring specifications on the manifold specification sheet. (Note that double and 3 position valves cannot be used where single solenoid wiring has been specified.)

### SI unit part no.

Symbol	SI unit specifications	SI unit part no.	Page
Nil	NPN output (+ COM.)	EX510-S001	WEB catalog
N	PNP output (- COM.)	EX510-S101	WEB catalog

Refer to the **WEB catalog** and the Operation Manual for the details of the EX510 Gateway-type Serial Transmission System. Please download the Operation Manual via our website, <http://www.smcworld.com>

## How to Order Valve

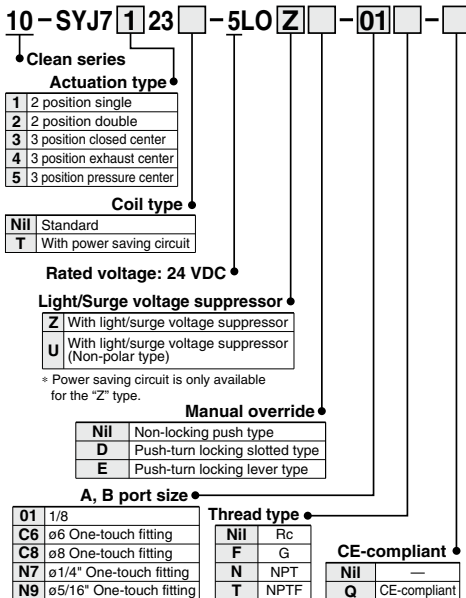

## How to Order Manifold Assembly (Example)

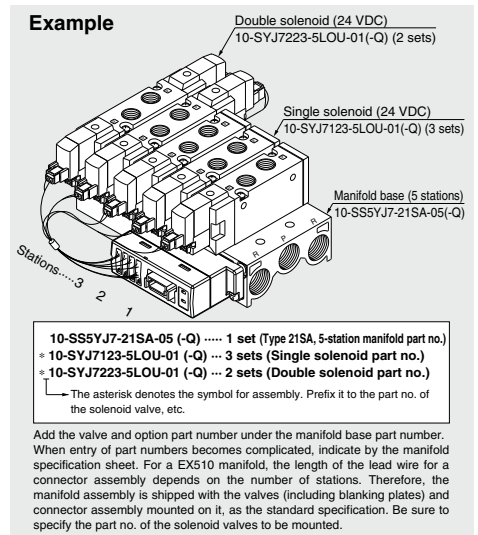

# Series 10-SYJ7000

EX510 Gateway-type Serial Transmission System  
Base Mounted Manifold



## How to Order Manifold

10-SS5YJ7-41SA [ ] - 03 - 01 [ ] - [ ]

Clean series

SI unit

Nil	NPN output (+ COM.)
N	PNP output (- COM.)

CE-compliant

Nil	—
Q	CE-compliant

Valve stations

Symbol	Stations	Note
03	3 stations	Double wiring <sup>Note 1)</sup>
08	8 stations	
03	3 stations	Specified layout <sup>Note 2)</sup> (Up to 16 solenoids)
16	16 stations	

<sup>1)</sup> Includes the number of the blanking plate assemblies.  
Note 1) Double wiring: Use of a single solenoid will result in an unused control signal. If this is not desired, order with a specified layout.

Note 2) Specified layout: Indicate wiring specifications on the manifold specification sheet. (Note that double and 3 position valves cannot be used where single solenoid wiring has been specified.)

P, R, A, B port thread type

Nil	Rc
F	G
N	NPT
T	NPTF

A, B port size

01	1/8
----	-----

SI unit part no.

Symbol	SI unit specifications	SI unit part no.	Page
Nil	NPN output (+ COM.)	EX510-S001	WEB catalog
N	PNP output (- COM.)	EX510-S101	WEB catalog

Refer to the **WEB catalog** and the Operation Manual for the details of the EX510 Gateway-type Serial Transmission System. Please download the Operation Manual via our website, <http://www.smcworld.com>

## How to Order Valve

10-SYJ7 [ ] 1 43 [ ] - 5LO [ ] Z [ ] - [ ]

Clean series

Actuation type

1	2 position single
2	2 position double
3	3 position closed center
4	3 position exhaust center
5	3 position pressure center

Coil type

Nil	Standard
T	With power saving circuit

Rated voltage: 24 VDC

Light/Surge voltage suppressor

Z	With light/surge voltage suppressor
U	With light/surge voltage suppressor (Non-polar type)

\* Power saving circuit is only available for the "Z" type.

Manual override

Nil	Non-locking push type
D	Push-turn locking slotted type
E	Push-turn locking lever type

CE-compliant

Nil	—
Q	CE-compliant

## How to Order Manifold Assembly (Example)

### Example

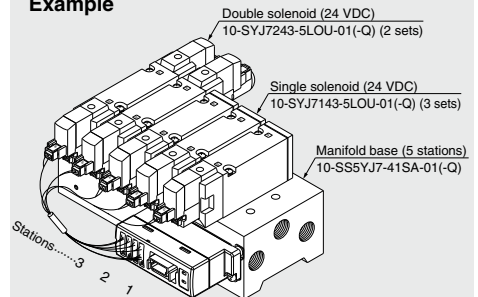

10-SS5YJ7-41SA-05 (-Q) ..... 1 set (Type 41SA, 5-station manifold part no.)  
 \* 10-SYJ7143-5LOU-01 (-Q) ... 3 sets (Single solenoid part no.)  
 \* 10-SYJ7243-5LOU-01 (-Q) ... 2 sets (Double solenoid part no.)  
 The asterisk denotes the symbol for assembly. Prefix it to the part no. of the solenoid valve, etc.

Add the valve and option part number under the manifold base part number. When entry of part numbers becomes complicated, indicate by the manifold specification sheet. For a EX510 manifold, the length of the lead wire for a connector assembly depends on the number of stations. Therefore, the manifold assembly is shipped with the valves (including blanking plates) and connector assembly mounted on it, as the standard specification. Be sure to specify the part no. of the solenoid valves to be mounted.

Directional Control Valves  
 Air Cylinders  
 Rotary Actuators  
 Air Grippers  
 Air Preparation Equipment  
 Modular F. R.  
 Pressure Control Equipment  
 Fittings & Tubing  
 Flow Control Equipment  
 Pressure Switches/ Pressure Sensors

Note) AC-type models that are CE-compliant have DIN terminals only.



**Individual Wiring**

**Common SUP/Common EXH**

**Type 20 (5 port/Body ported)**

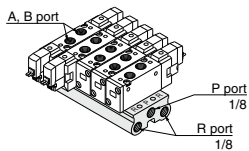

How to Order

**10-SS5YJ7-20-05** - [ ] - [ ]

Clean series

Stations

02	2 stations
:	:
15	15 stations

P, R port thread type

Nll	Rc
00F	G
00N	NPT
00T	NPTF

CE-compliant

Nll	—
Q	CE-compliant

Applicable solenoid valve

10-SYJ□23-□□□□-01 C6 N7(-Q) C8 N9

Applicable blanking plate assembly

Refer to page 360.

Applicable individual EXH spacer assembly

Refer to page 359.

Note) For more than 6 stations, supply pressure to P port on both sides and exhaust from R port on both sides.

**Type 21 (5 port/Body ported)**

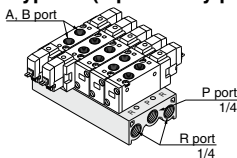

How to Order

**10-SS5YJ7-21-05** - [ ] - [ ]

Clean series

Stations

02	2 stations
:	:
20	15 stations

P, R port thread type

Nll	Rc
00F	G
00N	NPT
00T	NPTF

CE-compliant

Nll	—
Q	CE-compliant

Applicable individual EXH spacer assembly

Refer to page 359.

Note) For more than 10 stations, supply pressure to P port on both sides and exhaust from R port on both sides.

**Type 40 (5 port/Base mounted)**

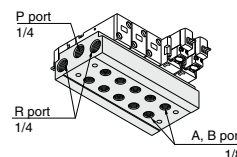

How to Order

**10-SS5YJ7-40-05-01** - [ ] - [ ]

Clean series

Stations

02	2 stations
:	:
20	20 stations

A, B port size

01	1/8
----	-----

Thread type

Nll	Rc
F	G
N	NPT
T	NPTF

CE-compliant

Nll	—
Q	CE-compliant

Applicable solenoid valve

10-SYJ□43-□□□□(-Q)

Applicable blanking plate assembly

Refer to page 360.

Applicable individual EXH spacer assembly

Refer to page 359.

Note) For more than 10 stations, supply pressure to P port on both sides and exhaust from R port on both sides.

**Type 41 (5 port/Base mounted)**

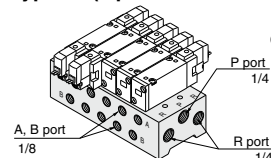

How to Order

**10-SS5YJ7-41-05-01** - [ ] - [ ]

Clean series

Stations

02	2 stations
:	:
20	20 stations

Thread type

Nll	Rc
F	G
N	NPT
T	NPTF

CE-compliant

Nll	—
Q	CE-compliant

Applicable individual EXH spacer assembly

Refer to page 359.

Applicable individual SUP spacer assembly

Refer to page 359.

Note) For more than 8 stations, supply pressure to P port on both sides and exhaust from R port on both sides.

**Type 42 (5 port/Base mounted)**

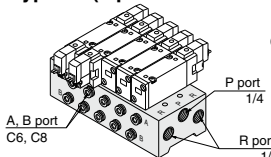

How to Order

**10-SS5YJ7-42-05-C6** - [ ] - [ ]

Clean series

Stations

02	2 stations
:	:
20	20 stations

A, B port size

C6	ø6 One-touch fitting
C8	ø8 One-touch fitting
N7	ø1/4" One-touch fitting
N9	ø5/16" One-touch fitting

Thread type

Nll	Rc
F	G
N	NPT
T	NPTF

CE-compliant

Nll	—
Q	CE-compliant

Note) For more than 8 stations, supply pressure to P port on both sides and exhaust from R port on both sides.



Note) CE-compliant:  
For DC only. [Option]

## Flat Ribbon Cable Manifold

### Common SUP/Common EXH

#### Type 21P (5 port/Body ported)

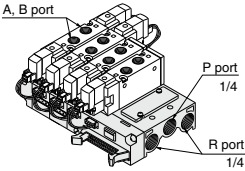

How to Order

**10-SS5YJ7-21P-05** - [ ] - [ ]

Clean series

Stations

03	3 stations
:	:
12	12 stations

P, R port thread type

Nil	Rc
00F	G
00N	NPT
00T	NPTF

CE compliant

Nil	—
Q	CE compliant

**Applicable solenoid valve**  
Refer to page 353.

**Applicable blanking plate assembly**  
Refer to page 360.

**Applicable connector assembly**  
Refer to page 353.

Note) For more than 10 stations, supply pressure to P port on both sides and exhaust from R port on both sides.

## EX510 Gateway-type Serial Transmission System

#### Type 21SA (5 port/Body ported)

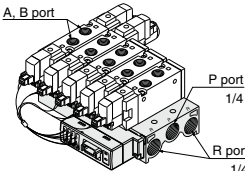

How to Order

**10-SS5YJ7-21SA** [ ] - **03** - [ ] - [ ]

Clean series

Valve stations

Nil	Stations	Note
03	3 stations	
:	:	Double wiring (Note 1)
08	8 stations	
03	3 stations	Specified layout (Note 2) (Up to 16 solenoids)
:	:	
16	16 stations	

P, R port thread type

Nil	Rc
00F	G
00N	NPT
00T	NPTF

CE-compliant

Nil	—
Q	CE-compliant

**Applicable solenoid valve**  
Refer to page 355.

**Applicable blanking plate assembly**  
Refer to page 360.

SI unit\*

Nil	NPN output (+ COM.)
N	PNP output (- COM.)

\* Includes the number of the blanking plate assemblies.

Note 1) Double wiring: Use of a single solenoid will result in an unused control signal. If this is not desired, order with a specified layout.

Note 2) Specified layout: Indicate wiring specifications on the manifold specification sheet. (Note that double and 3 position valves cannot be used where single solenoid wiring has been specified.)

#### Type 41SA (5 port/Base mounted)

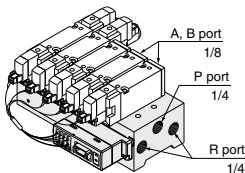

How to Order

**10-SS5YJ7-41SA** [ ] - **03** - **01** - [ ] - [ ]

Clean series

Valve stations

Nil	Stations	Note
03	3 stations	
:	:	Double wiring (Note 1)
08	8 stations	
03	3 stations	Specified layout (Note 2) (Up to 16 solenoids)
:	:	
16	16 stations	

A, B port size

01	1/8
----	-----

P, R, A, B port thread type

Nil	Rc
F	G
N	NPT
T	NPTF

CE-compliant

Nil	—
Q	CE-compliant

**Applicable solenoid valve**  
Refer to page 356.

**Applicable blanking plate assembly**  
Refer to page 360.

SI unit\*

Nil	NPN output (+ COM.)
N	PNP output (- COM.)

\* Includes the number of the blanking plate assemblies.

Note 1) Double wiring: Use of a single solenoid will result in an unused control signal. If this is not desired, order with a specified layout.

Note 2) Specified layout: Indicate wiring specifications on the manifold specification sheet. (Note that double and 3 position valves cannot be used where single solenoid wiring has been specified.)

Directional Control Valves  
Air Cylinders  
Rotary Actuators  
Air Grippers  
Air Preparation Equipment  
Modular F. R.  
Pressure Control Equipment  
Fittings & Tubing  
Flow Control Equipment  
Pressure Switches/ Pressure Sensors



## Combinations of Solenoid Valve, Manifold Gasket and Manifold Base

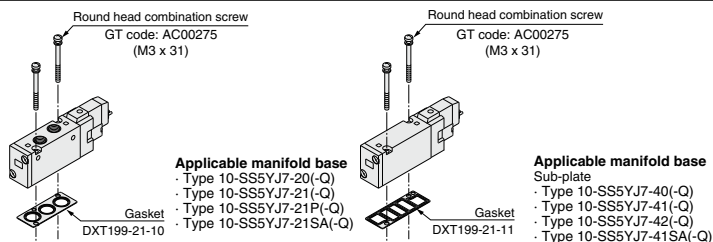

## Individual EXH Spacer Assembly

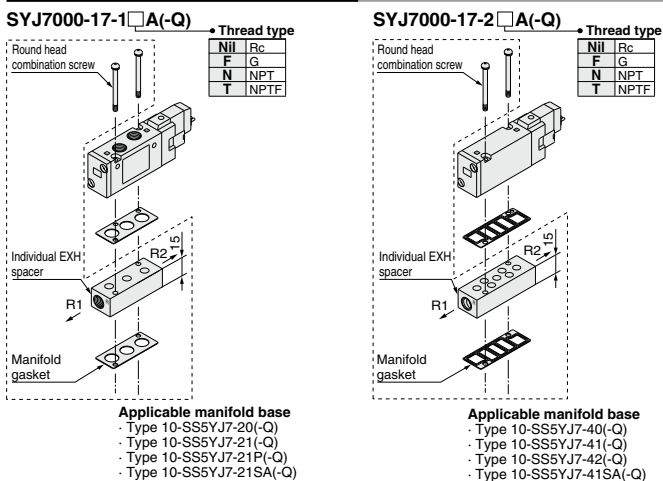

## Individual SUP Spacer Assembly

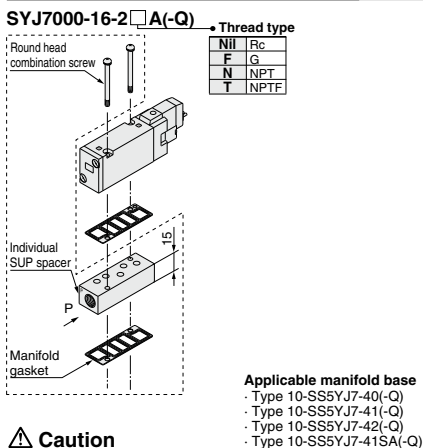

### ⚠ Caution

Mounting screw tightening torque

M3: 0.8 N·m

Use caution to the assembly orientation for solenoid valves, gasket, and optional parts.

## Mix Installation of the 10-SYJ700 and the 10-SYJ7000 Valves on the Same Manifold

- Use of an adapter plate makes it possible to mount the 10-SYJ700 on the 10-SYJ7000 manifold bases.
- When mounting the SYJ700 valve on the 10-SYJ7000 manifold, the SYJ700 pilot valve must be positioned on the same side of the manifold as a SYJ7000 single solenoid. (Refer to the figure below.)
- For base mounted type, the A port of the 3 port valve flows out the B port of the manifold base.

### Adapter plate assembly SYJ700-3-1A(-Q)

SYJ700 series  
Body ported

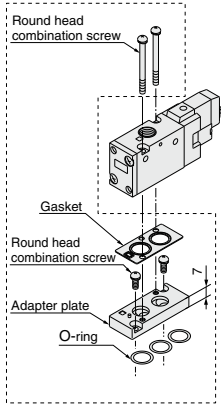

**Applicable manifold base**  
 · Type 10-SS5YJ7-20(-Q)  
 · Type 10-SS5YJ7-21(-Q)  
 · Type 10-SS5YJ7-21P(-Q)  
 · Type 10-SS5YJ7-21SA(-Q)

### Adapter plate assembly SYJ700-3-2A(-Q)

SYJ700 series  
Base mounted

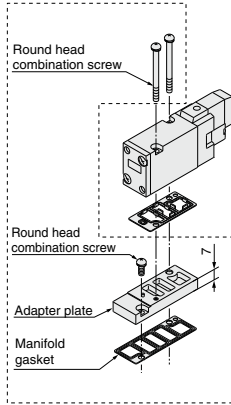

**Applicable manifold base**  
 · Type 10-SS5YJ7-40(-Q)  
 · Type 10-SS5YJ7-41(-Q)  
 · Type 10-SS5YJ7-42(-Q)  
 · Type 10-SS5YJ7-41SA(-Q)

## Blanking Plate Assembly

### <Standard> SYJ7000-21-1A

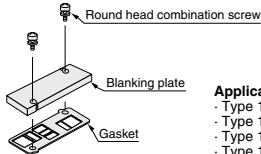

**Applicable manifold base**  
 · Type 10-SS5YJ7-20  
 · Type 10-SS5YJ7-21  
 · Type 10-SS5YJ7-40  
 · Type 10-SS5YJ7-41  
 · Type 10-SS5YJ7-42  
 · Type 10-SS5YJ7-41SA

### SYJ7000-21-3A

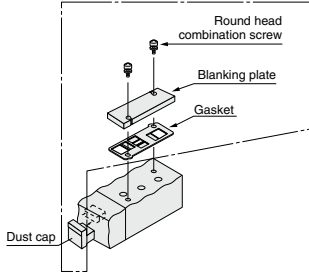

**Applicable manifold base**  
 · Type 10-SS5YJ7-21P

### <CE-compliant> SYJ7000-21-1A-1-Q

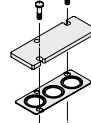

**Applicable manifold base**  
 · Type 10-SS5YJ7-20-Q  
 · Type 10-SS5YJ7-21-Q  
 · Type 10-SS5YJ7-21SA-Q

### SYJ7000-21-1A-2-Q

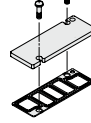

**Applicable manifold base**  
 · Type 10-SS5YJ7-40-Q  
 · Type 10-SS5YJ7-41-Q  
 · Type 10-SS5YJ7-42-Q  
 · Type 10-SS5YJ7-41SA-Q

### SYJ7000-21-3A-Q

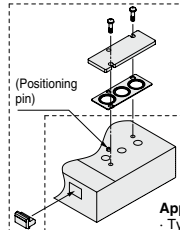

**Applicable manifold base**  
 · Type 10-SS5YJ7-21P-Q

**Grommet (G)**

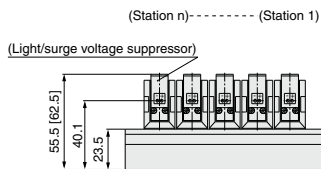
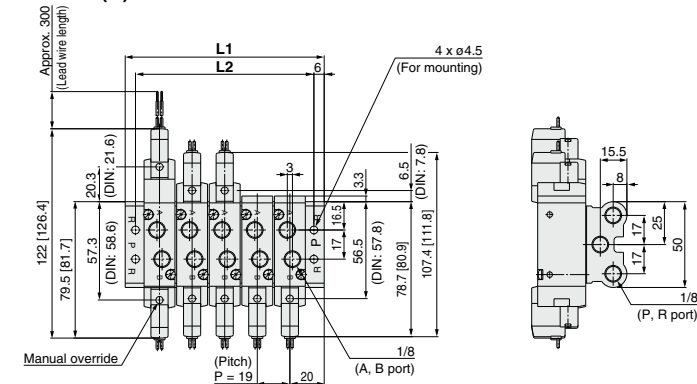

**Built-in One-touch fitting**

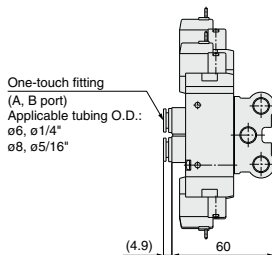

**L plug connector (L)**

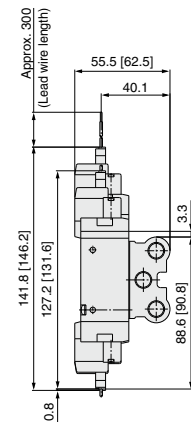

**M plug connector (M)**

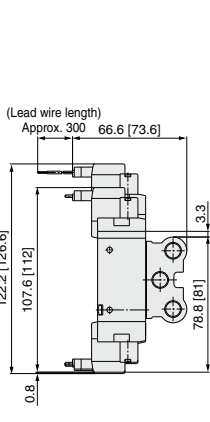

**DIN terminal (D, Y)**

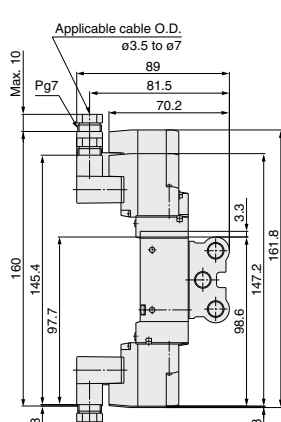

**M8 connector (WO)**

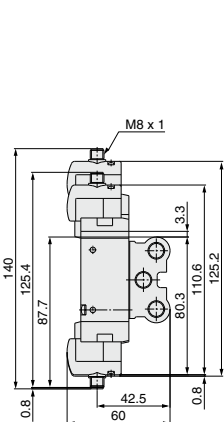

\* Refer to page 375 for dimensions with connector cable.

Station	Station 2	3	4	5	6	7	8	9	10	11	12	13	14	Station 15
L1	59	78	97	116	135	154	173	192	211	230	249	268	287	306
L2	47	66	85	104	123	142	161	180	199	218	237	256	275	294

**Type 21: Top Ported/10-SS5YJ7-21- Stations (-00□)**

\* [ ] : AC

**Grommet (G)**

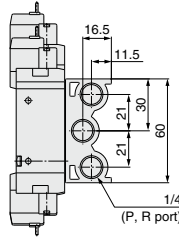
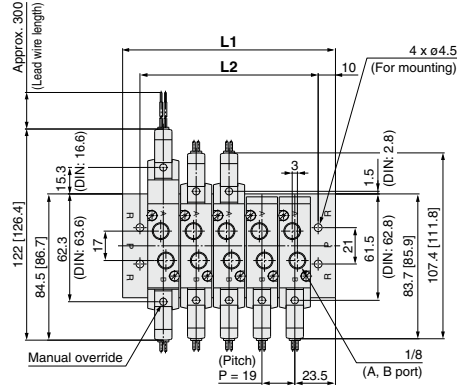

**Built-in One-touch fitting**

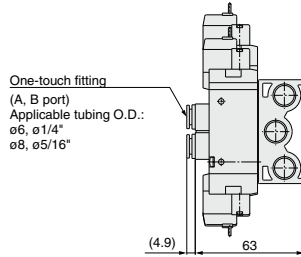
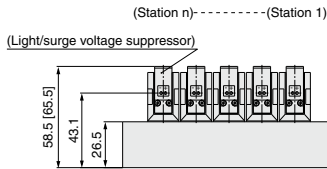

**L plug connector (L)**

**M plug connector (M)**

**DIN terminal (D, Y)**

**M8 connector (WO)**

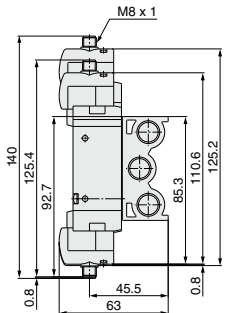
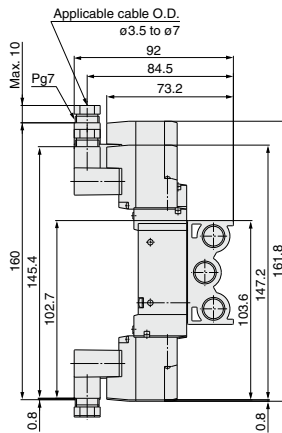
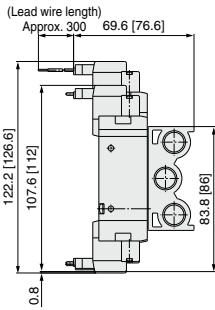
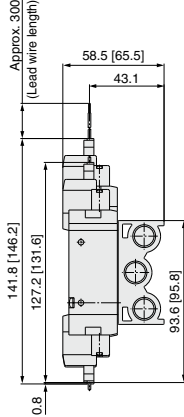

\* Refer to page 375 for dimensions with connector cable.

Station	Station 2	3	4	5	6	7	8	9	10	11	12	13	14	15	16	17	18	19	Station 20
L1	66	85	104	123	142	161	180	199	218	237	256	275	294	313	332	351	370	389	408
L2	46	65	84	103	122	141	160	179	198	217	236	255	274	293	312	331	350	369	388

Directional Control Valves  
 Air Cylinders  
 Rotary Actuators  
 Air Grippers  
 Air Preparation Equipment  
 Modular F. R.  
 Pressure Control Equipment  
 Fittings & Tubing  
 Flow Control Equipment  
 Pressure Switches/ Pressure Sensors

**Type 40: Bottom Ported/10-SS5YJ7-40- Stations -01** □

\* [ ] : AC

**Grommet (G)**

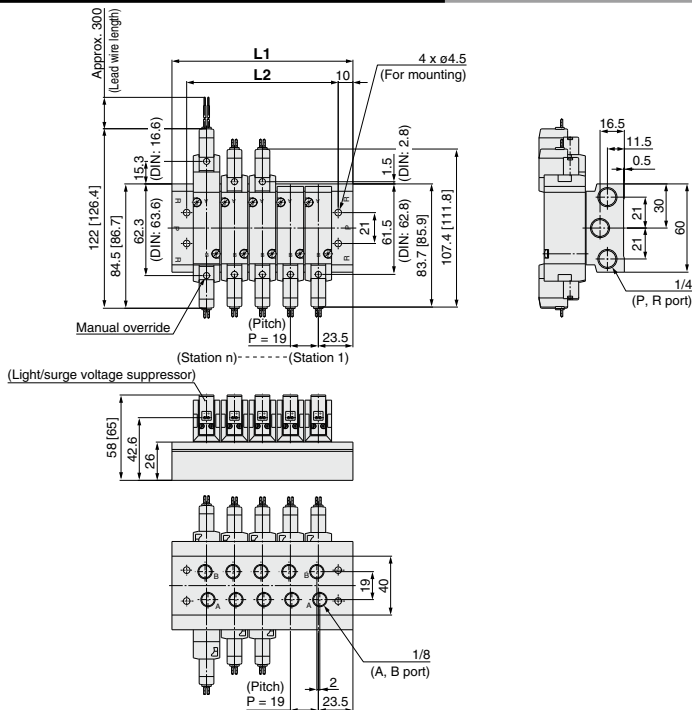

**L plug connector (L)**

**M plug connector (M)**

**DIN terminal (D, Y)**

**M8 connector (WO)**

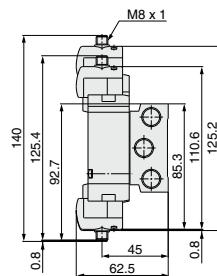
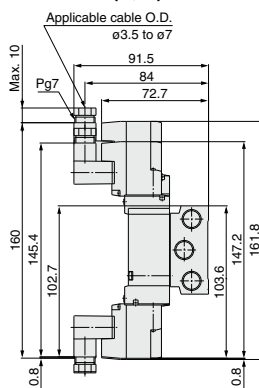
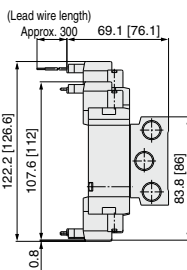
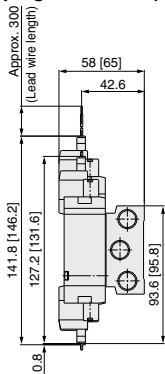

\* Refer to page 375 for dimensions with connector cable.

Station	Station 2	3	4	5	6	7	8	9	10	11	12	13	14	15	16	17	18	19	Station 20
L1	66	85	104	123	142	161	180	199	218	237	256	275	294	313	332	351	370	389	408
L2	46	65	84	103	122	141	160	179	198	217	236	255	274	293	312	331	350	369	388

**Type 41: Side Ported/10-SS5YJ7-41- Stations -01** □

\* [ ]: AC

**Grommet (G)**

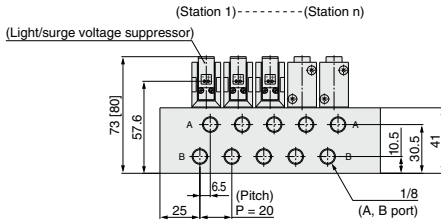
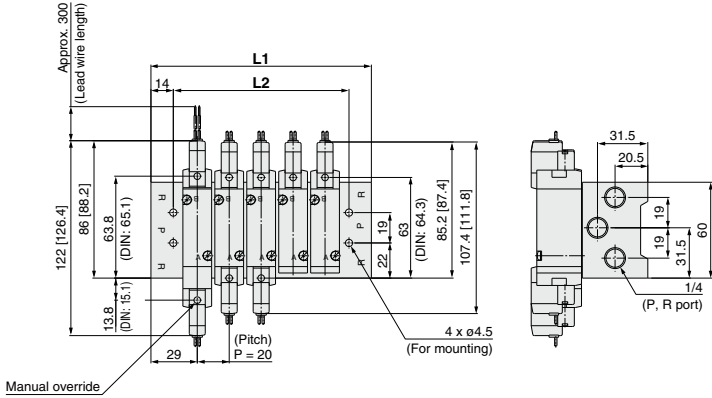

**L plug connector (L)**

**M plug connector (M)**

**DIN terminal (D, Y)**

**M8 connector (WO)**

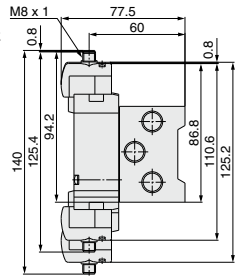
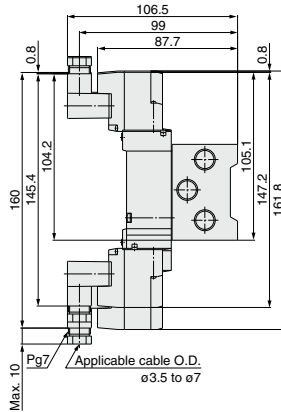
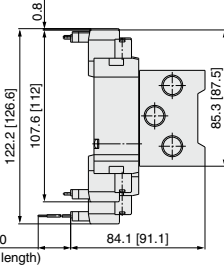
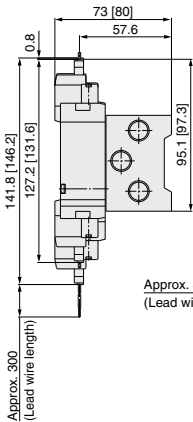

\* Refer to 375 for dimensions with connector cable.

Station	Station 2	3	4	5	6	7	8	9	10	11	12	13	14	15	16	17	18	19	Station 20
L1	78	98	118	138	158	178	198	218	238	258	278	298	318	338	358	378	398	418	438
L2	50	70	90	110	130	150	170	190	210	230	250	270	290	310	330	350	370	390	410

Directional Control Valves

Air Cylinders

Rotary Actuators

Air Grippers

Air Preparation Equipment

Modular F. R.

Pressure Control Equipment

Fittings & Tubing

Flow Control Equipment

Pressure Switches/ Pressure Sensors

Type 42: Side Ported/10-SS5YJ7-42-**Stations**-**C6, N7**  
**C8, N9** □

\* [ ]: AC

**Grommet (G)**

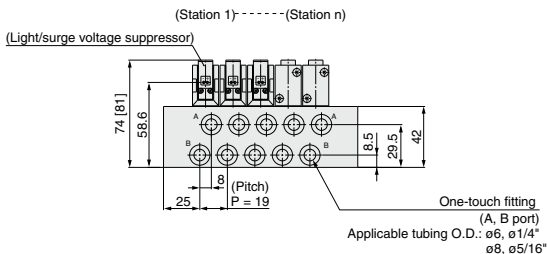
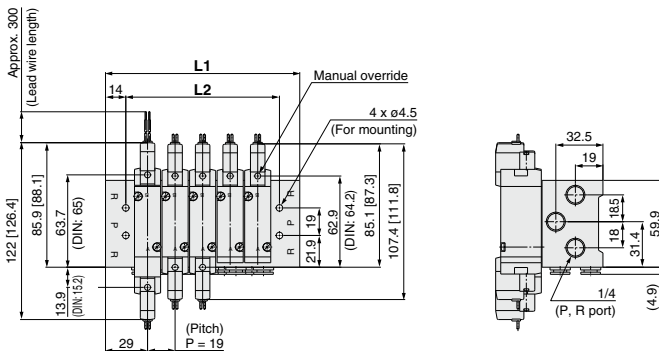

**L plug connector (L)**

**M plug connector (M)**

**DIN terminal (D, Y)**

**M8 connector (WO)**

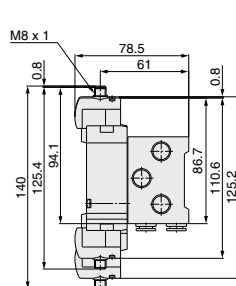
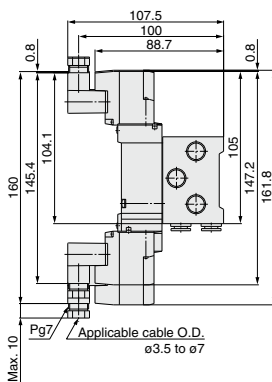
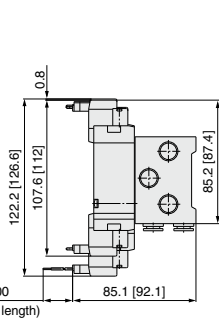
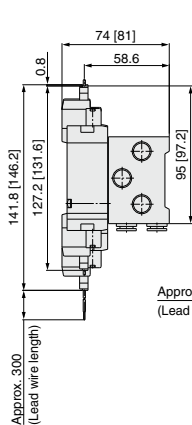

\* Refer to page 375 for dimensions with connector cable.

Station	Station 2	3	4	5	6	7	8	9	10	11	12	13	14	15	16	17	18	19	Station 20
L1	77	96	115	134	153	172	191	210	229	248	267	286	305	324	343	362	381	400	419
L2	49	68	87	106	125	144	163	182	201	220	239	258	277	296	315	334	353	372	391

**Flat Ribbon Cable Manifold**

\* [ ] : AC

**10-SS5YJ7-21P- Stations (□)**

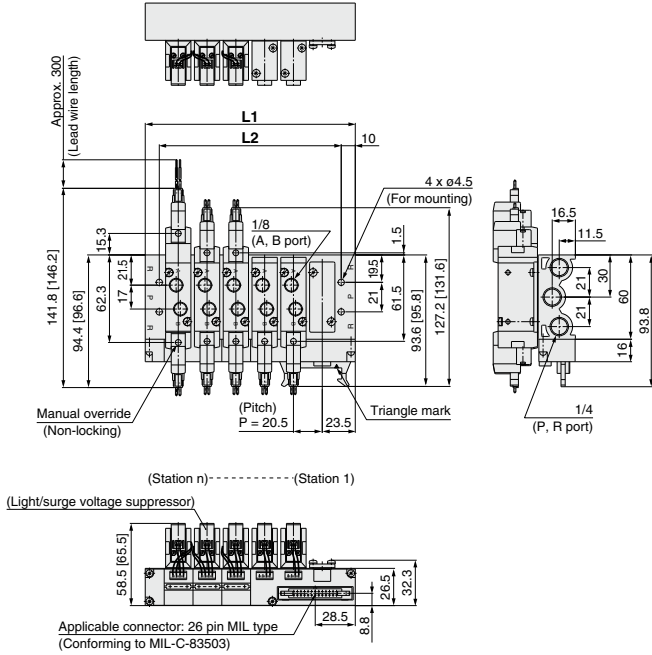

**Built-in One-touch fitting**

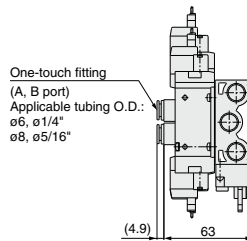

Station	Station 3	4	5	6	7	8	9	10	11	Station 12
L1	88	108.5	129	149.5	170	190.5	211	231.5	252	272.5
L2	68	88.5	109	129.5	150	170.5	191	211.5	232	252.5

Directional  
Control Valves

Air Cylinders

Rotary Actuators

Air Grippers

Air Preparation  
Equipment

Modular F. R.

Pressure Control  
Equipment

Fittings & Tubing

Flow Control  
Equipment

Pressure Switches/  
Pressure Sensors





**EX510 Gateway-type Serial Transmission System**

**10-SS5YJ7-41SA□ - Stations -01□**

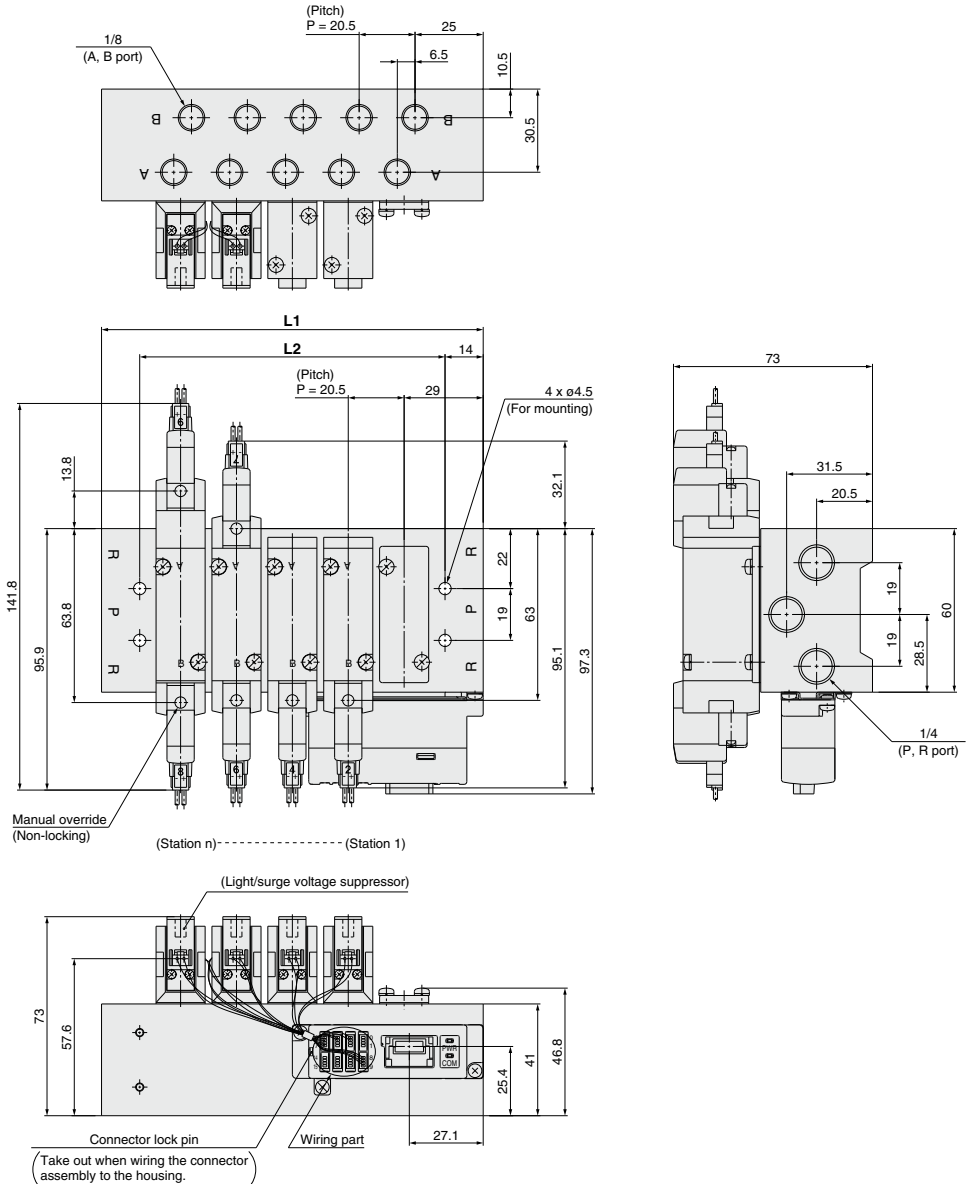

Station	Station 3	4	5	6	7	8	9	10	11	12	13	14	15	Station 16
<b>L1</b>	99	119.5	140	160.5	181	201.5	222	242.5	263	283.5	304	324.5	345	365.5
<b>L2</b>	71	91.5	112	132.5	153	173.5	194	214.5	235	255.5	276	296.5	317	337.5

Directional Control Valves

Air Cylinders

Rotary Actuators

Air Grippers

Air Preparation Equipment

Modular F. R.

Pressure Control Equipment

Fittings & Tubing

Flow Control Equipment

Pressure Switches/ Pressure Sensors



### How to Order Valve

**Light/Surge voltage suppressor**

<b>Nil</b>	Without light/surge voltage suppressor
<b>S</b>	With surge voltage suppressor
<b>Z</b>	With light/surge voltage suppressor
<b>R</b>	With surge voltage suppressor (Non-polar type)
<b>U</b>	With light/surge voltage suppressor (Non-polar type)

**Rated voltage**

<b>5</b>	24 VDC
<b>6</b>	12 VDC
<b>V</b>	6 VDC
<b>S</b>	5 VDC
<b>R</b>	3 VDC

**A, B port size**

Thread piping		
Symbol	Port size	Applicable series
<b>M3</b>	M3 x 0.5	10-SYJ3000
<b>M5</b>	M5 x 0.8	10-SYJ5000
<b>01</b>	1/8	10-SYJ7000

**Actuation type**

<b>1</b>	2 position single solenoid
<b>2</b>	2 position double solenoid
<b>3</b>	3 position closed center
<b>4</b>	3 position exhaust center
<b>5</b>	3 position pressure center

**One-touch fitting piping (Metric size)**

Symbol	Port size	Applicable series
<b>C4</b>	ø4 One-touch fitting	10-SYJ5000
<b>C6</b>	ø6 One-touch fitting	
<b>C6</b>	ø6 One-touch fitting	10-SYJ7000
<b>C8</b>	ø8 One-touch fitting	

**Bracket**

<b>Nil</b>	Without bracket
<b>F</b>	With bracket

Note) Do not remove the factory installed bracket from the 10-SYJ7000 series with the bracket option. Removal of the bracket will cause the valve to leak.

**One-touch fitting piping (Inch size)**

Symbol	Port size	Applicable series
<b>N3</b>	ø5/32" One-touch fitting	10-SYJ5000
<b>N7</b>	ø1/4" One-touch fitting	
<b>N7</b>	ø1/4" One-touch fitting	10-SYJ7000
<b>N9</b>	ø5/16" One-touch fitting	

**Body option**

**3:** Main/Pilot valve common exhaust type

**Electrical entry**

**WAO:** Without connector cable

**WA□:** With connector cable Note)

**Body ported**  
10-SYJ 3 1 2 3 - 5 WAO □ □ - M3 - □ - □

**Base mounted (4 port)**  
10-SYJ3 2 3 3 - 5 WAO □ □ - □ (For manifold use only)

**Base mounted (5 port)**  
10-SYJ 3 2 4 3 - 5 WAO □ □ - □ - □

**CE-compliant**

<b>Nil</b>	—
<b>Q</b>	CE-compliant

**Clean series**

Series	
<b>3</b>	10-SYJ3000
<b>5</b>	10-SYJ5000
<b>7</b>	10-SYJ7000

**Port size**

Symbol	Without sub-plate	Applicable series
<b>Nil</b>	Without sub-plate	10-SYJ3000
<b>M5</b>	M5 x 0.8	
<b>01</b>	1/8	10-SYJ5000
<b>02</b>	1/4	
		10-SYJ7000

**Manual override**

<b>Nil</b>	Non-locking push type
<b>D</b>	Push-turn locking slotted type
<b>E</b>	Push-turn locking lever type

Note) Enter the cable length symbol in □.  
Please be sure to fill in the blank referring to page 374.

### How to Order Pilot Valve Assembly

V111-5 WAO □

**Rated voltage**

DC	
<b>5</b>	24 VDC
<b>6</b>	12 VDC
<b>V</b>	6 VDC
<b>S</b>	5 VDC
<b>R</b>	3 VDC

**Light/Surge voltage suppressor**

<b>Nil</b>	Without light/surge voltage suppressor
<b>S</b>	With surge voltage suppressor
<b>Z</b>	With light/surge voltage suppressor
<b>R</b>	With surge voltage suppressor (Non-polar type)
<b>U</b>	With light/surge voltage suppressor (Non-polar type)

**Electrical entry**

<b>WAO</b>	Without connector cable
<b>WA□</b>	M8 connector With connector cable <small>Note)</small>

Note) Enter the cable length symbol in □.  
Please be sure to fill in the blank referring to page 374.

Note) Since V111 is CE-compliant as standard, the suffix "-Q" is not necessary.



# Series 10-SYJ3000/5000/7000 Specific Product Precautions 1

Be sure to read this before handling.

Refer to page 1382 for Safety Instructions and pages 677 to 683 for 3/4/5 Port Solenoid Valve Precautions.

## Manual Override Operation

### Warning

When the manual override is operated, connected equipment will be actuated. Confirm safety before operating.

#### ■ Non-locking push type [Standard]

Press in the direction of the arrow.



#### ■ Push-turn locking slotted type [Type D]

While pressing the lock down, turn it in the direction of the arrow.

If it does not turn, it can be operated the same way as the non-locking type.

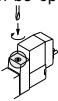

Locked position



### Caution

When operating the locking type D with a screw driver, turn it gently using a watchmakers screw driver.

[Torque: Less than 0.1 N·m]

#### ■ Push-turn locking lever type [Type E]

While pressing the lever down, turn it in the direction of the arrow.

If it does not turn, it can be operated the same way as the non-locking type.



Locked position



### Caution

When locking the manual override on the push-turn locking types (D, E), be sure to push the lock down before turning it. Turning without first pushing it down can cause damage to the manual override and trouble such as air leakage, etc.

## Solenoid Valve for 200, 220 VAC Specifications

### Warning

Solenoid valves with grommet and L/M type plug connector AC specifications have a built-in rectifier circuit in the pilot section to operate the DC coil.

With 200, 220 VAC specification pilot valves, this built-in rectifier generates heat when energized. The surface may become hot depending on the energization state; therefore, do not touch the solenoid valves.

## 10-SYJ3000/5000/7000 Series Mixed Installation of 3 Port and 5 Port Valves on Same Manifold

### Caution

The 10-SYJ3000/5000/7000 and 10-SYJ300/500/700 series can be mounted on the same manifold. How to mount on the same manifold is shown on the following pages.

10-SYJ3000, 10-SYJ300	.....	P. 301
10-SYJ5000, 10-SYJ500	.....	P. 330
10-SYJ7000, 10-SYJ700	.....	P. 360

When using 4/5 port valves as a 3 port valve

The 10-SYJ3000/5000/7000/9000 series can be used as normally closed (N.C.) or normally open (N.O.) 3 port valves by closing one of the cylinder ports (A or B) with a plug. However, they should be used with the exhaust ports kept open. Can be used when a double solenoid, 3 port valve is required.

Plug position		B port	A port
Actuation type		N.C.	N.O.
Number of solenoids	Single		
	Double		

(Symbols above: Series 10-SYJ5000)

Directional Control Valves

Air Cylinders

Rotary Actuators

Air Grippers

Air Preparation Equipment

Modular F. R.

Pressure Control Equipment

Fittings & Tubing

Flow Control Equipment

Pressure Switches/ Pressure Sensors



# Series 10-SYJ3000/5000/7000 Specific Product Precautions 2

Be sure to read this before handling.

Refer to page 1382 for Safety Instructions and pages 677 to 683 for 3/4/5 Port Solenoid Valve Precautions.

## How to Use Plug Connector

### ⚠ Caution

#### 1. Attaching and detaching connectors

- To attach a connector, hold the lever and connector unit between your fingers and insert straight onto the pins of the solenoid valve so that the lever's pawl is pushed into the groove and locks.
- To detach a connector, remove the pawl from the groove by pushing the lever downward with your thumb, and pull the connector straight out.

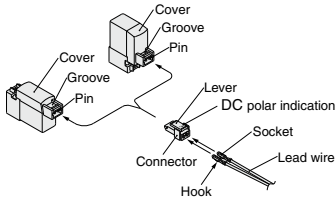

#### 2. Crimping connection of lead wire and socket

Strip 3.2 to 3.7 mm at the end of the lead wires, insert the end of the core wires evenly into the sockets, and then crimp it with a crimping tool. When this is done, take care that the coverings of the lead wires do not enter the core wire crimping area.

Use an exclusive crimping tool for crimping.  
(Please contact SMC for the dedicated crimping tools.)

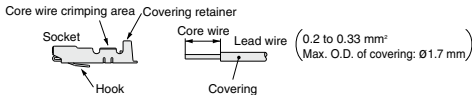

#### 3. Attaching and detaching sockets with lead wires

##### • Attaching

Insert the sockets into the square holes of the connector (+, - indication), and continue to push the sockets all the way in until they lock by hooking into the seats in the connector. (When they are pushed in, the hooks open and they are locked automatically.) Then confirm that they are locked by pulling lightly on the lead wires.

##### • Detaching

To detach a socket from a connector, pull out the lead wire while pressing the socket's hook with a thin tipped stick (approx. 1 mm). If the socket is to be used again, first spread the hook outward.

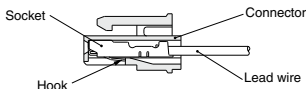

## Plug Connector Lead Wire Length

### ⚠ Caution

Standard length is 300 mm, but the following lengths are also available.

#### How to Order Connector Assembly

For DC: **SY100-30-4A**

For 100 VAC: **SY100-30-1A**

For 200 VAC: **SY100-30-2A**

For other voltages of AC: **SY100-30-3A**

Without lead wire: **SY100-30-A**  
(with connector and 2 of sockets only)

• Lead wire length

Nil	300 mm
6	600 mm
10	1000 mm
15	1500 mm
20	2000 mm
25	2500 mm
30	3000 mm
50	5000 mm

#### How to Order

Specify the part numbers of the solenoid valve without connector and the connector assembly with protective cover separately.

Example) Lead wire length 2000 mm

**For DC**                      **For AC**  
10-SYJ3120-5LO-M3      10-SYJ3120-1LO-M3  
SY100-30-4A-20          SY100-30-1A-20





# Series 10-SYJ3000/5000/7000 Specific Product Precautions 4

Be sure to read this before handling.  
Refer to page 1382 for Safety Instructions and pages 677 to 683 for 3/4/5 Port Solenoid Valve Precautions.

## Surge Voltage Suppressor

<For AC>

(There is no "S" option, because the generation of surge voltage is prevented by a rectifier.)

### Grommet, L/M Plug Connector

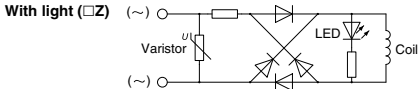

### DIN Terminal

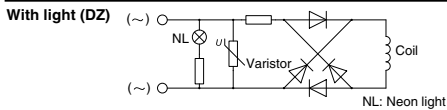

Note) The surge voltage suppressor of the varistor has residual voltage corresponding to the protective element and rated voltage. Therefore, protect the controller side from the surge voltage. The residual voltage of the diode is approximately 1 V.

## How to Use DIN Terminal

### ⚠ Caution Connection

- Loosen the holding screw and pull the connector out of the solenoid valve terminal block.
- After removing the holding screw, insert a flat head screwdriver, etc. into the notch on the bottom of the terminal block and pry it open, separating the terminal block and the housing.
- Loosen the terminal screws (slotted screws) on the terminal block, insert the cores of the lead wires into the terminals according to the connection method, and fasten them securely with the terminal screws.
- Secure the cord by fastening the gland nut.

### ⚠ Caution

When making connections, take note that using other than the supported size ( $\phi 3.5$  to  $\phi 7$ ) heavy duty cord will not satisfy IP65 (enclosure) standards. Also, be sure to tighten the gland nut and holding screw within their specified torque ranges.

### Changing the entry direction

After separating the terminal block and housing, the cord entry can be changed by attaching the housing in the desired direction (4 directions at 90° intervals).

\* When equipped with a light, be careful not to damage the light with the cord's lead wires.

### Precautions

Plug in and pull out the connector vertically without tilting to one side.

### Compatible cable

Cord O.D.:  $\phi 3.5$  to  $\phi 7$   
(Reference) 0.5mm<sup>2</sup>, 2-core or 3-core, equivalent to JIS C 3306

## How to Use DIN Terminal

### ⚠ Caution

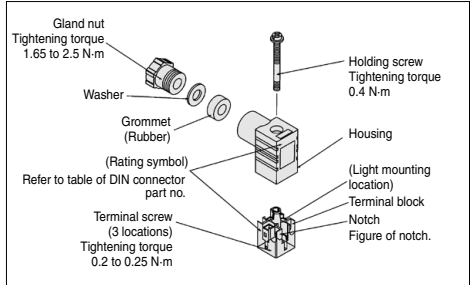

Type "Y"

DIN connector type Y is a DIN connector that conforms to the DIN pitch 8-mm standard.

- D type DIN connector with 9.4 mm pitch between terminals is not interchangeable.
- To distinguish from the D type DIN connector, "N" is listed at the end of voltage symbol. (For connector parts without lights, "N" is not indicated. Please refer to the name plate to distinguish.)
- Dimensions are completely the same as D type DIN connector.
- When exchanging the pilot valve assembly only, "V115-□D" is interchangeable with "V115-□Y". Do not replace V111 (G, L, M) to V115-□D/□Y (DIN terminal), and vice versa.

## DIN Connector Part No.

### ⚠ Caution

<Type D>

Without light		SY100-61-1
<b>With light</b>		
Rated voltage	Voltage symbol	Part no.
24 VDC	24V	SY100-61-3-05
12 VDC	12V	SY100-61-3-06
100 VAC	100V	SY100-61-2-01
200 VAC	200V	SY100-61-2-02
110 VAC	110V	SY100-61-2-03
220 VAC	220V	SY100-61-2-04

<Type Y>

Without light		SY100-82-1
<b>With light</b>		
Rated voltage	Voltage symbol	Part no.
24 VDC	24VN	SY100-82-3-05
12 VDC	12VN	SY100-82-3-06
100 VAC	100VN	SY100-82-2-01
200 VAC	200VN	SY100-82-2-02
110 VAC (115 VAC)	110VN	SY100-82-2-03
220 VAC (230 VAC)	220VN	SY100-82-2-04

### Circuit Diagram with Light

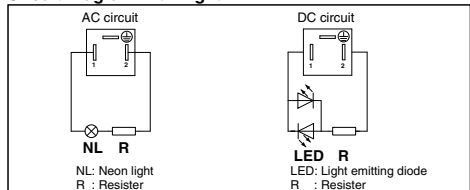







# Series 10-SYJ3000/5000/7000 Specific Product Precautions 6

Be sure to read this before handling.  
Refer to page 1382 for Safety Instructions and pages 677 to 683 for 3/4/5 Port Solenoid Valve Precautions.

## M8 Connector

### 2. To order connector cable only

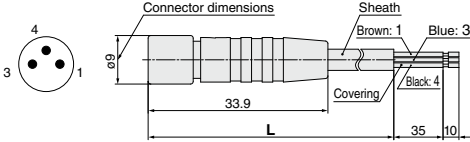

Cable length (L)	Part no.	Sheath O.D.	ø3.4 mm
300 mm	V100-49-1-1	Cover diameter	ø1.16 mm
500 mm	V100-49-1-2	Conductor area	0.16 mm <sup>2</sup>
1000 mm	V100-49-1-3		
2000 mm	V100-49-1-4		
5000 mm	V100-49-1-7		

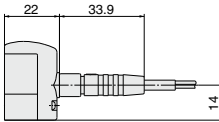

## Flat Ribbon Cable Manifold

### Caution

Type 21P

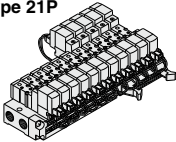

Type 32P

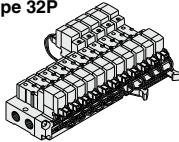

- In the manifold valves, the wiring to the individual valves is provided on a printed circuit board, and the connection to the external wires is consolidated through the use of a flat ribbon cable.
- A single MIL type flat ribbon cable connects the entire manifold to your power source. This greatly reduces installation time.

## Flat Ribbon Cable Manifold

### Manifold Internal Wiring

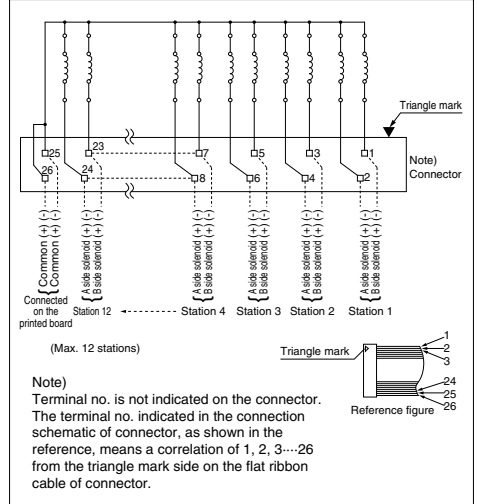

- For more than 10 stations, both poles of the common should be wired.
- For single solenoid, connect to the B side solenoid.
- The maximum number of stations that can be accommodated is 12. For more stations, contact SMC.
- Only non-polar valves are available for the DC flat ribbon cable manifold, therefore negative COM or positive COM wiring of the manifold is possible. The valve does not switch with negative COM if a Z type is used. Be sure to use a positive COM.

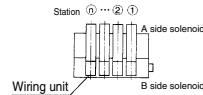



# Series 10-SYJ3000/5000/7000 Specific Product Precautions 7

Be sure to read this before handling.

Refer to page 1382 for Safety Instructions and pages 677 to 683 for 3/4/5 Port Solenoid Valve Precautions.

## EX510 Gateway-type Serial Transmission System

When ordering the connector assembly only

For single solenoid (SY3000-37-81A-□-N)

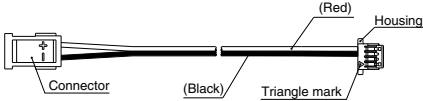

For double solenoid (SY3000-37-81A-□-□)

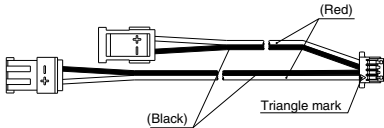

Connector Assembly Order No.

(Can be used for the manifold without a specified layout (8 stations or less))

Model	Part no.	Connector mounting position
10-SS5YJ3- <sup>20</sup> / <sub>41</sub> SA	SY3000-37-81A-2-N	Single : For 1 to 4 stations
	SY3000-37-81A-2-5	Double/3 position: For 1 to 4 stations
	SY3000-37-81A-1-N	Single : For 5 to 8 stations
10-SS5YJ5- <sup>20</sup> / <sub>41</sub> SA	SY3000-37-81A-1-4	Double/3 position: For 5 to 8 stations
	SY3000-37-81A-2-N	Single : For 1 to 8 stations
	SY3000-37-81A-2-5	Double/3 position: For 1 to 8 stations
10-SS5YJ7- <sup>20</sup> / <sub>41</sub> SA	SY3000-37-81A-3-N	Single : For 1 to 8 stations
	SY3000-37-81A-3-6	Double/3 position: For 1 to 4 stations
	SY3000-37-81A-3-7	Double/3 position: For 5 to 8 stations

Note) The above is for the station addition or maintenance. When ordering a connector assembly separately, the number is not printed on the connector.

When ordering connector assembly (except housing)

SY3000-37-80A-□

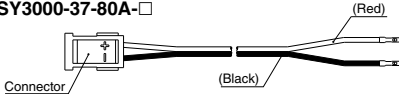

Connector Assembly Order No.

(Can be used for the manifold with a specified layout)

Model	Part no.	Connector mounting position
10-SS5YJ3- <sup>21</sup> / <sub>32</sub> SA	SY3000-37-80A-5	For A side
	SY3000-37-80A-2	For B side
	SY3000-37-80A-7	For A side
	SY3000-37-80A-4	For B side
10-SS5YJ5- <sup>20</sup> / <sub>41</sub> SA	SY3000-37-80A-5	For A side
	SY3000-37-80A-2	For B side
	SY3000-37-80A-7	For A side
	SY3000-37-80A-4	For B side
10-SS5Y7- <sup>21</sup> / <sub>32</sub> SA	SY3000-37-80A-9	For A side
	SY3000-37-80A-7	For B side
	SY3000-37-80A-3	For A side
	SY3000-37-80A-10	For B side
	SY3000-37-80A-6	For A side
	SY3000-37-80A-12	For B side

Note 1) The above is for station addition or maintenance. When ordering a connector assembly separately, the number is not printed on the connector.

Note 2) After inserting the connector assembly into the housing, be sure to confirm that the lead wire will not come off by tightly pulling the wire. Furthermore, do not reuse the lead wire after it has been inserted and removed.

Note 3) Wiring is set longer than the actual wiring distance.

When ordering the housing only

SY3000-44-3A (8 pcs/set)

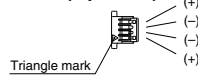

Bracket

**Caution**

For bracket attached types of 10-SYJ3000 (Single) and 10-SYJ7000, do not use it without bracket.

Solenoid Valve Mounting

**Caution**

Mount so that there is no slippage or deformation in gaskets, and tighten with the tightening torque as shown below.

Series	Thread size	Tightening torque
10-SYJ3000	M1.7	0.12 N·m
10-SYJ5000	M2.5	0.45 N·m
10-SYJ7000	M3	0.8 N·m

Replacement of Pilot Valve

**Caution**

Pilot valves in this series are improved to provide excellent energy saving results. However following this improvement, these new valves are no longer compatible with the existing pilot valve used at the interface. Consult with SMC if you need to exchange these pilot valves, for manual override (marked in orange) of the adapter plate.

New valve

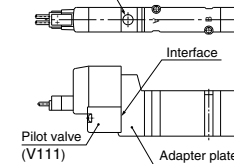
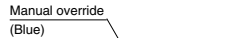

Existing valve

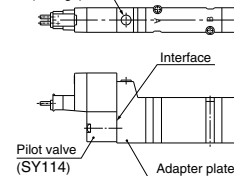
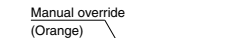

Directional Control Valves

Air Cylinders

Rotary Actuators

Air Grippers

Air Preparation Equipment

Modular F. R.

Pressure Control Equipment

Fittings & Tubing

Flow Control Equipment

Pressure Switches/ Pressure Sensors