



Operation Manual

Solenoid Valve

PRODUCT NAME

VQ4000/5000
(Pilot Valve V100)

MODEL/ Series

SMC Corporation

Contents

Safety Instructions	2,3
Precautions on Design	4,5,6
Selection	4,5,6
Mounting	6
Piping	6
Wiring	6
Lubrication	7
Air Supply	7
Operating Environment	7
Maintenance	7,8
Specific Product Precautions	9 ~11
Construction and optional parts	12~15
Trouble shooting	16,17



Safety Instructions

These safety instructions are intended to prevent hazardous situations and/or equipment damage. These instructions indicate the level of potential hazard with the labels of “Caution,” “Warning” or “Danger.” They are all important notes for safety and must be followed in addition to International Standards (ISO/IEC)*1), and other safety regulations.

- *1) ISO 4414: Pneumatic fluid power -- General rules relating to systems
- ISO 4413: Hydraulic fluid power -- General rules relating to systems
- IEC 60204-1: Safety of machinery -- Electrical equipment of machines (Part 1: General requirements)
- ISO 10218-1992: Manipulating industrial robots -- Safety



Caution

Caution indicates a hazard with a low level of risk which, if not avoided, could result in minor or moderate injury.



Warning

Warning indicates a hazard with a medium level of risk which, if not avoided, could result in death or serious injury.



Danger

Danger indicates a hazard with a high level of risk which, if not avoided, will result in death or serious injury.

Warning

1. The compatibility of the product is the responsibility of the person who designs the equipment or decides its specifications.

Since the product specified here is used under various operating conditions, its compatibility with specific equipment must be decided by the person who designs the equipment or decides its specifications based on necessary analysis and test results.

The expected performance and safety assurance of the equipment will be the responsibility of the person who has determined its compatibility with the product.

This person should also continuously review all specifications of the product referring to its latest catalog information, with a view to giving due consideration to any possibility of equipment failure when configuring the equipment.

2. Only personnel with appropriate training should operate machinery and equipment.

The product specified here may become unsafe if handled incorrectly.

The assembly, operation and maintenance of machines or equipment including our products must be performed by an operator who is appropriately trained and experienced.

3. Do not service or attempt to remove product and machinery/equipment until safety is confirmed.

1. The inspection and maintenance of machinery/equipment should only be performed after measures to prevent falling or runaway of the driven objects have been confirmed.

2. When the product is to be removed, confirm that the safety measures as mentioned above are implemented and the power from any appropriate source is cut, and read and understand the specific product precautions of all relevant products carefully.

3. Before machinery/equipment is restarted, take measures to prevent unexpected operation and malfunction.

4. Contact SMC beforehand and take special consideration of safety measures if the product is to be used in any of the following conditions.

1. Conditions and environments outside of the given specifications, or use outdoors or in a place exposed to direct sunlight.

2. Installation on equipment in conjunction with atomic energy, railways, air navigation, space, shipping, vehicles, military, medical treatment, combustion and recreation, or equipment in contact with food and beverages, emergency stop circuits, clutch and brake circuits in press applications, safety equipment or other applications unsuitable for the standard specifications described in the product catalog.

3. An application which could have negative effects on people, property, or animals requiring special safety analysis.

4. Use in an interlock circuit, which requires the provision of double interlock for possible failure by using a mechanical protective function, and periodical checks to confirm proper operation.



Safety Instructions

Caution

The product is provided for use in manufacturing industries.

The product herein described is basically provided for peaceful use in manufacturing industries.

If considering using the product in other industries, consult SMC beforehand and exchange specifications or a contract if necessary.

If anything is unclear, contact your nearest sales branch.

Limited warranty and Disclaimer/Compliance Requirements

The product used is subject to the following "Limited warranty and Disclaimer" and "Compliance Requirements".

Read and accept them before using the product.

Limited warranty and Disclaimer

1. The warranty period of the product is 1 year in service or 1.5 years after the product is delivered.*2)

Also, the product may have specified durability, running distance or replacement parts. Please consult your nearest sales branch.

2. For any failure or damage reported within the warranty period which is clearly our responsibility, a replacement product or necessary parts will be provided.

This limited warranty applies only to our product independently, and not to any other damage incurred due to the failure of the product.

3. Prior to using SMC products, please read and understand the warranty terms and disclaimers noted in the specified catalog for the particular products.

*2) Vacuum pads are excluded from this 1 year warranty.

A vacuum pad is a consumable part, so it is warranted for a year after it is delivered.

Also, even within the warranty period, the wear of a product due to the use of the vacuum pad or failure due to the deterioration of rubber material are not covered by the limited warranty.

Compliance Requirements

1. The use of SMC products with production equipment for the manufacture of weapons of mass destruction (WMD) or any other weapon is strictly prohibited.

2. The exports of SMC products or technology from one country to another are governed by the relevant security laws and regulation of the countries involved in the transaction. Prior to the shipment of a SMC product to another country, assure that all local rules governing that export are known and followed.



5-Port Solenoid Valves Precautions 1

Be sure to read this before handling products.

Design/Selection

Warning

- 1. Confirm the specifications.**

Products represented in this catalog are designed only for use in compressed air systems (including vacuum). Do not operate at pressures, temperatures, etc., beyond the range of specifications, as this can cause damage or malfunction. (Refer to the specifications.) Please contact SMC when using a fluid other than compressed air (including vacuum). We do not guarantee against any damage if the product is used outside of the specification range.
- 2. Actuator drive**

When an actuator, such as a cylinder, is to be driven using a valve, take appropriate measures (such as the installation of a cover or the restricting of access to the product) to prevent potential danger caused by actuator operation.
- 3. Intermediate stops**

For the 3-position closed center or double check valve types, it is difficult to make the piston stop at the required position accurately due to the compressibility of air. Furthermore, since valves and cylinders are not guaranteed for zero air leakage, it may not be possible to hold a stopped position for an extended period of time. Please contact SMC if it is necessary to hold a stopped position for an extended period of time.
- 4. Effects of back pressure when using a manifold**

Use caution when valves are used on a manifold because actuators may malfunction due to back pressure. For the 3-position exhaust center valve or single acting cylinder, take appropriate measures to prevent malfunction by using it with an individual EXH spacer assembly, a back pressure check valve, or an individual exhaust manifold.
- 5. Holding pressure (including vacuum)**

Since valves are subject to air leakage, they cannot be used for applications such as holding pressure (including vacuum) in a pressure vessel.
- 6. Not suitable for use as an emergency shutoff valve, etc.**

The valves listed in this catalog are not designed for safety applications such as an emergency shutoff valve. If the valves are used in such applications, additional safety measures should be adopted.
- 7. Release of residual pressure**

For maintenance and inspection purposes install a system for releasing residual pressure. Especially in the case of the 3-position closed center valve or double check valve types, ensure that the residual pressure between the valve and the cylinder is released.
- 8. Operation in a vacuum condition**

When a valve is used for switching a vacuum, take measures to install a suction filter or similar to prevent external dust or other foreign matter from entering inside the valve. In addition, at the time of vacuum adsorption, be sure to supply a constant supply of vacuum. Failure to do so may result in foreign matter sticking to the adsorption pad or air leakage, causing the workpiece to drop.
- 9. Regarding vacuum switch valves and vacuum release valves**

If a non-vacuum valve is installed in the middle of a piping system that contains a vacuum, the vacuum condition will not be maintained. Use a valve designed for use under vacuum conditions.
- 10. Double solenoid type**

When using the double solenoid type for the first time, actuators may travel in an unexpected direction depending on the switching position of the valve. Implement measures to prevent any danger from occurring when operating the actuator.

11. Ventilation

Provide ventilation when using a valve in a confined area, such as in a closed control panel. For example, install a ventilation opening, etc., in order to prevent pressure from increasing inside of the confined area and to release the heat generated by the valve.

12. Extended periods of continuous energization

• If a valve will be continuously energized for an extended period of time, the temperature of the valve will increase due to the heat generated by the coil assembly. This will likely adversely affect the performance of the valve and any nearby peripheral equipment. Therefore, when it is continuously energized or the energized period per day is longer than the de-energized period use the valve with a power saving circuit. As a valve not mentioned above can also be used depending on the operating conditions (in particular, DC specification valves), please contact SMC for further information.

• For applications such as mounting a valve on a control panel, incorporate measure to limit the heat radiation so that the temperature will be high when a 3 station manifold.

13. Do not disassemble the product or make any modifications, including additional machining.

Doing so may cause human injury and/or an accident.

14. Pilot exhaust

Mount the silencer to both D and U side of the pilot exhaust port (PE) or exhaust the air to the atmosphere. If the pilot exhaust is common with the main exhaust, the main valve may malfunction due to back pressure.

Caution

1. Precautions for 2-position double solenoid valves

If a double solenoid valve is operated with momentary energization, it should be energized for at least 0.1 seconds. However, depending on the piping conditions, the cylinder may malfunction even when the double solenoid valve is energized for 0.1 seconds or longer. In this case, energize the double solenoid valve until the cylinder is exhausted completely.

2. Leakage voltage

Take note that the leakage voltage will increase when a resistor is used in parallel with a switching element or when a C-R circuit (surge voltage suppressor) is used for protecting a switching device because of the leakage voltage passing through the C-R circuit. The suppressor residual leakage voltage should be as follows.

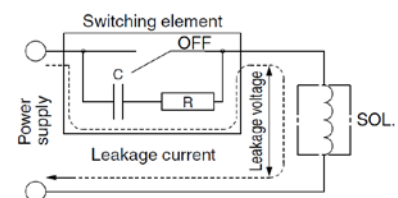

DC coil: 3% or less of the rated voltage

AC coil: 8% or less of the rated voltage



5-Port Solenoid Valves Precautions 2

Be sure to read this before handling products.

Design/Selection

Caution

3. Solenoid valve drive for AC with a solid state output (SSR, TRIAC output, etc.)

1) Current leakage

When using a snubber circuit (C-R element) for surge protection of the output, a very small amount of electrical current will continue to flow even during the OFF state.

This results in the valve not returning. In a situation where the tolerance is exceeded, as in the above case, take measures to install a bleeder resistor.

2) Minimum allowable load amount (Min. load current)

When the consumption current of a valve is less than the output's minimum allowable load volume or the margin is small, the output may not switch normally. Please contact SMC.

3) Solenoid valve with full wave rectifier circuit

When the solenoid valve built-in full wave rectifier circuit with AC specifications is used, a return failure of the solenoid valve may occur depending on the kind of triac output circuit. Carefully check this point when selecting a SSR or sequencer.

For details, contact the SSR or sequencer manufacturer.

4. Surge voltage suppressor

1) The surge voltage suppressor built into the valve is intended to protect the output contacts so that the surge generated inside valve does not adversely affect the output contacts. Therefore, if an overvoltage or overcurrent is received from an external peripheral device, the surge voltage protection element inside the valve is overloaded, causing the element to break. In the worst case, the breakage causes the electric circuit to enter short-circuit status. If energizing continues while in this state, a large current flows. This may cause secondary damage to the output circuit, external peripheral device, or valve, and may also cause a fire. So, take appropriate protective measures, such as the installation of an overcurrent protection circuit in the power supply or a drive circuit to maintain a sufficient level of safety.

2) If a surge protection circuit contains nonstandard diodes, such as Zener diodes or varistor, a residual voltage that is in proportion to the protective circuit and the rated voltage will remain. Therefore, take into consideration the surge voltage protection of the controller. In the case of diodes, the residual voltage is approximately 1 V.

5. Surge voltage intrusion

With non-polar type solenoid valves, at times of sudden interruption of the loading power supply, such as emergency shutdown, surge voltage intrusion may be generated from loading equipment with a large capacity (power consumption), and a solenoid valve in a de-energized state may switch over (see Figure 1).

When installing a breaker circuit for the loading power supply, consider using a solenoid valve with polarity (with polarity protection diode), or install a surge absorption diode between the loading equipment COM line and the output equipment COM line (see Figure 2).

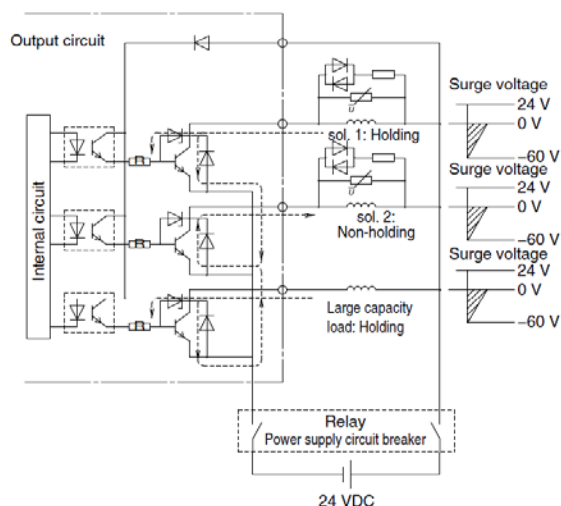

Figure 1. Surge intrusion circuit example (NPN outlet example)

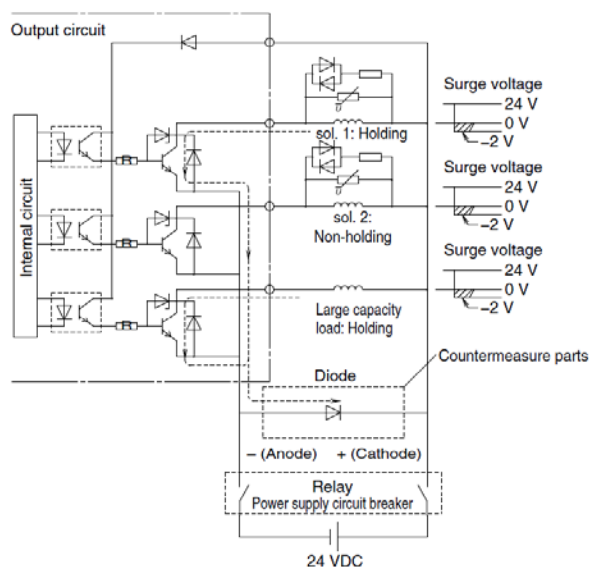

Figure 2. Surge intrusion countermeasure example (NPN outlet example)



5-Port Solenoid Valves Precautions 3

Be sure to read this before handling products.

Design/Selection

⚠ Caution

- 6. Operation in low temperature conditions**
It is possible to operate a valve in extreme temperatures, as low as -10°C. Take appropriate measures to avoid the freezing of drainage, moisture, etc., in low temperatures.
- 7. Operation for air blowing**
When using a solenoid valve for air blowing, use an external pilot type. Use caution because the pressure drop caused by the air blowing can have an effect on the internal pilot type valve when internal pilot type valves and external pilot type valves are used on the same manifold.
Additionally, when compressed air within the pressure range of the established specifications is supplied to the external pilot type valve's port, and a double solenoid valve is used for air blowing, the solenoids should be energized when air is being blown.
- 8. Mounting orientation**
Rubber seal: The mounting orientation is universal.
Metal seal: The mounting orientation of a single solenoid is universal. No specific orientation is necessary. When installing a double solenoid or a 3-position configuration, mount the valve so that the spool valve is horizontal.

Mounting

⚠ Warning

- 1. Operation manual**
Install the products and operate them only after reading the operation manual carefully and understanding its contents. Also, keep the manual where it can be referred to as necessary.
- 2. Ensure sufficient space for maintenance activities.**
When installing the products, allow access for maintenance and inspection.
- 3. Tighten threads with the proper tightening torque.**
When installing the products, follow the listed torque specifications.
- 4. If air leakage increases or equipment does not operate properly, stop operation.**
Check mounting conditions when air and power supplies are connected. Initial function and leakage tests should be performed after installation.
- 5. Painting and coating**
Warnings or specifications printed on or affixed to the product should not be erased, removed, or covered up. Please consult with SMC before applying paint to resinous parts, as this may have an adverse effect due to the solvent in the paint.

Piping

⚠ Caution

- 1. Refer to the Fittings and Tubing Precautions for handling One-touch fittings.**

2. Preparation before piping

Before piping is connected, it should be thoroughly blown out with air (flushing) or washed to remove chips, cutting oil, and other debris from inside the pipe

3. Winding of sealant tape

When screwing piping or fittings into ports, ensure that chips from the pipe threads or sealing material do not enter the piping. Also, if sealant tape is used, leave 1 thread ridge exposed at the end of the threads.

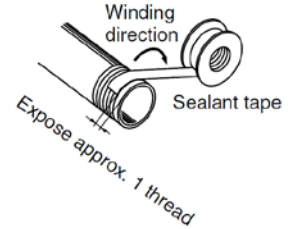

4. Closed center and double check valve types

For the closed center or double check valve types, check the piping to prevent air leakage from the piping between the valve and the cylinder.

5. Connection of piping and fittings

When screwing piping or fittings into the valve, tighten them as follows.

- 1) For a fitting with sealant R or NPT, first, tighten it by hand, then use a suitable wrench to tighten the hexagonal portion of the body an additional two or three turns. For the tightening torque, refer to the table below.

Connection thread size (R, NPT)	Proper tightening torque (N·m)
1/8	3 to 5
1/4	8 to 12
3/8	15 to 20
1/2	20 to 25

- 2) If the fitting is tightened with excessive torque, a large amount of sealant will seep out. Remove the excess sealant.
- 3) Insufficient tightening may cause seal failure or loosen the threads.
- 4) For reuse
 - (1) Normally, fittings with a sealant can be reused up to 2 to 3 times.
 - (2) To prevent air leakage through the sealant, remove any loose sealant stuck to the fitting by blowing air over the threaded portion.
 - (3) If the sealant no longer provides effective sealing, wind sealing tape over the sealant before reusing. Do not use any form of sealant other than the tape type of sealant.
 - (4) Once the fitting has been tightened, backing it out to its original position often causes the sealant to become defective. Air leakage will occur.

6. Piping to products

When piping to a product, refer to the operation manual to avoid mistakes regarding the supply port, etc

Wiring

⚠ Warning

- 1. The solenoid valve is an electrical product. For safety, install an appropriate fuse and circuit breaker before use.**

⚠ Caution

- 1. Polarity**
There is no polarity.



5-Port Solenoid Valves Precautions 4

Be sure to read this before handling products.

Wiring

Caution

2. Applied voltage

When electric power is connected to a solenoid valve, be careful to apply the proper voltage. Improper voltage may cause malfunction or coil damage.

3. Check the connections.

Check if the connections are correct after completing all wiring.

4. External force applied to the lead wire

If an excessive force is applied to the lead wire, this may cause faulty wiring. Take appropriate measures so that a force of 30 N or more is not applied to the lead wire.

Lubrication

Warning

1. Lubrication

[Rubber seal]

1) The valve has been lubricated for life by the factory and does not require any further.

2) If a lubricant is used in the system, use class 1 turbine oil (no additives), ISO VG32. For details about lubricant manufacturers' brands, refer to the SMC website. Additionally, please contact SMC for details about class 2 turbine oil (with additives) ISO VG32. Once lubricant is utilized within the system, since the original lubricant applied within the product during manufacturing will be washed away, please continue to supply lubrication to the system. Without continued lubrication, malfunctions could occur. If turbine oil is used, refer to the Safety Data Sheet (MSDS) of the oil.

[Metal seal]

1) These valves can be used without lubrication.

2) If a lubricant is used in the system, use class 1 turbine oil (no additives), ISO VG32. For details about lubricant manufacturers' brands, refer to the SMC website. Additionally, please contact SMC for details about class 2 turbine oil (with additives) ISO VG32.

2. Lubrication amount

If the lubrication amount is excessive, the oil may accumulate inside the pilot valve, causing malfunction or response delay.

So, do not apply a large amount of oil. When a large amount of oil needs to be applied, use an external pilot type to put the supply air on the pilot valve side in the non-lube state. This prevents the accumulation of oil inside the pilot valve.

Air Supply

Warning

1. Type of fluids

Please consult with SMC when using the product in applications other than compressed air.

2. When there is a large amount of drainage

Compressed air containing a large amount of drainage can cause the malfunction of pneumatic equipment. An air dryer or

water separator should be installed upstream from filters.

3. Drain flushing

If condensation in the drain bowl is not emptied on a regular basis, the bowl will overflow. This may cause the malfunction of pneumatic equipment. If the drain bowl is difficult to check and remove, the installation of a drain bowl with an auto drain option is recommended.

For compressed air quality, refer to the SMC Best Pneumatics No. 6 catalog.

4. Use clean air.

Do not use compressed air that contains chemicals, synthetic oils that include organic solvents, salt, corrosive gases, etc., as it can cause damage or malfunction.

Caution

1. **When extremely dry air is used as the fluid, degradation of the lubrication properties inside the equipment may occur, resulting in reduced reliability (or reduced service life) of the equipment. Please consult with SMC.**

2. Install an air filter.

Install an air filter upstream near the valve. Select an air filter with a filtration size of 5 µm or smaller.

3. **Take measures to ensure air quality, such as by installing an aftercooler, air dryer, or water separator.**

Compressed air that contains a large amount of drainage can cause the malfunction of pneumatic equipment, such as valves. Therefore, take appropriate measures to ensure air quality, such as by providing an aftercooler, air dryer, or water separator.

4. **If an excessive amount of carbon powder is present, install a mist separator on the upstream side of the valve.**

If excessive carbon dust is generated by the compressor, it may adhere to the inside of a valve and cause it to malfunction.

For compressed air quality, refer to the SMC Best Pneumatics No. 6 catalog.

Operating Environment

Warning

1. **Do not use in an atmosphere containing corrosive gases, chemicals, sea water, water, water steam, or where there is direct contact with any of these.**

2. **Products with IP65 and IP67 enclosures (based on IEC60529) are protected against dust and water. However, these products cannot be used in water.**

3. **Products compliant with IP65 and IP67 satisfy the product specifications when mounted properly. Be sure to read the precautions for each product.**

4. **Do not use in an environment where flammable gas or explosive gas exists. Usage may cause a fire or explosion. The products do not have an explosion proof construction.**



5-Port Solenoid Valves Precautions 5

Be sure to read this before handling products.

Operating Environment

Warning

5. Do not use in a place subject to heavy vibration and/or shock.
6. The valve should not be exposed to prolonged sunlight. Use a protective cover. Note that the valve is not for outdoor use.
7. Remove any sources of excessive heat.
8. If it is used in an environment where there is possible contact with oil, weld spatter, etc., exercise preventive measures.
9. When the solenoid valve is mounted in a control panel or it's energized for a long period of time, make sure the ambient temperature is within the specifications of the valve.

Caution

1. **Temperature of ambient environment**
Use the valve within the range of the ambient temperature specification of each valve. In addition, pay attention when using the valve in environments where the temperature changes drastically.
2. **Humidity of ambient environment**
 - When using the valve in environments with low humidity, take measures to prevent static.
 - If the humidity rises, take measures to prevent the adhesion of water droplets on the valve.

Maintenance

Warning

1. **Perform maintenance and inspection according to the procedures indicated in the operation manual.**
If handled improperly, human injury and/or malfunction or damage of machinery and equipment may occur.
2. **Removal of equipment, and supply/exhaust of compressed air**
Before components are removed, first confirm that measures are in place to prevent workpieces from dropping, run-away equipment, etc. Then, cut off the supply air and electric power, and exhaust all air pressure from the system using the residual pressure release function.
For the 3-position closed center or double check valve types, exhaust the residual pressure between the valve and the cylinder.
When the equipment is operated after remounting or replacement, first confirm that measures are in place to prevent the lurching of actuators, etc. Then, confirm that the equipment is operating normally.
In particular, when a 2-position double solenoid valve is used, releasing residual pressure rapidly may cause the spool valve to malfunction, depending on the piping conditions, or the connected actuator to operate.

3. **Low-frequency operation**

Valves should be operated at least once every 30 days to prevent malfunction. (Use caution regarding the air supply.)

4. **Manual override**

When a manual override is operated, connected equipment will be actuated.

Operate only after safety is confirmed.

5. **If the volume of air leakage increases or the valve does not operate normally, do not use the valve.**

Perform periodic maintenance on the valve to confirm the operating condition and check for any air leakage.

Caution

1. **Drain flushing**

Remove drainage from the air filters regularly.

2. **Lubrication**

In the case of rubber seals, once lubrication has been started, it must be continued.

Use class 1 turbine oil (with no additives), VG32. If other lubricant oil is used, it may cause a malfunction. Please contact SMC for information on the suggested class 2 turbine oil (with additives), VG32.

3. **Manual override operation**

When switching a double solenoid valve via the manual override operation, instantaneous operation may cause the malfunction of the cylinder. It is recommended that the manual override be held until the cylinder reaches the stroke end position.



VQ4000/5000 series

Specific Product Precautions 1

Be sure to read this before handling the products.

Continuous Duty

Warning

When the product is continuously energized for a long period of time (10 minutes or longer), select the low wattage type (DC specification). The AC type cannot be continuously energized for 10 minutes or longer. If anything is unclear, please contact SMC.

Manual Override

Warning

Since connected equipment will operate when the manual override is activated, confirm that conditions are safe prior to activation.

Push type (Tool required)

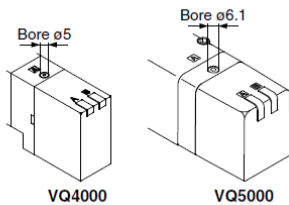

Push down the manual override button with a small screwdriver, etc., until it stops. The manual override will return when released.

Locking type (Tool required)

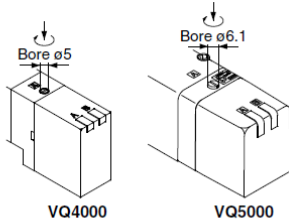

Push down the manual override button with a small flat head screwdriver until it stops, and turn it clockwise 90° to lock it. Turn it counterclockwise to release it.

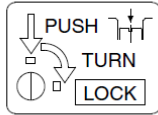

Locking type (Manual)

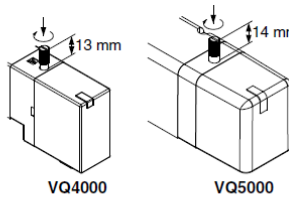

Push down the manual override button with a small flat head screwdriver or with your fingers until it stops. Turn it clockwise by 90° to lock it. Turn it counterclockwise to release it.

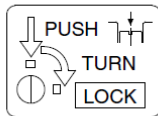

Caution

Do not apply excessive torque when turning the locking type manual override. (0.1 N·m or less)

Valve Mounting

Caution

After confirming that the gasket is installed correctly, securely tighten the mounting screws according to the tightening torque shown below.

VQ4000

Proper tightening torque [N·m]
0.8 to 1.2

VQ5000

Proper tightening torque [N·m]
1 to 1.8

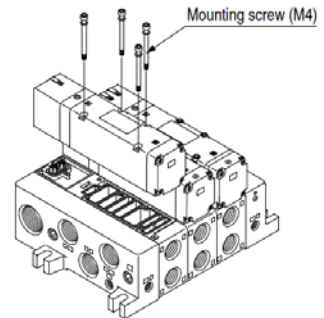
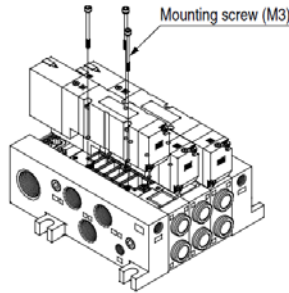

Replacement of One-touch Fittings/VQ4000

Caution

Cylinder port fittings are available in cassette type and can be replaced easily. Fittings are secured with a retaining clip that is inserted from the top side of the valve. After removing the valve, remove the clip with a flat head screwdriver to replace the fittings. To mount a fitting, insert the fitting assembly until it stops and reinsert the retaining clip to its designated position.

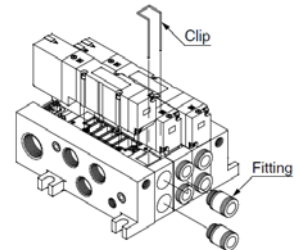

Lead Wire Connection

Caution

Plug-in sub-plate (With terminal block)

• If the junction cover ① of the sub-plate is removed, you can see the plug-in type terminal block ② mounted inside the sub-plate.

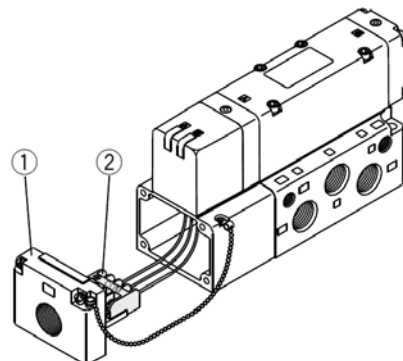



VQ4000/5000 series

Specific Product Precautions 2

Be sure to read this before handling the products.

Lead Wire Connection

Caution

- The terminal block is marked as follows. Connect wiring to each of the power supply terminals.

Model	Terminal block marking	A	COM	B	⎓
VQ ₄ ₅ ⁰ ₁ 10		A side	COM	—	—
VQ ₄ ₅ ⁰ ₁ 20		A side	COM	B side	—
VQ ₄ ₅ ⁰ ₁ 30		A side	COM	B side	—

Note 1) There is no polarity. It can also be used as –COM.

Note 2) The sub-plate is double wired even for the VQ(4,5)10(0,1)

- Applicable terminal: 1.25-3s, 1.25Y-3, 1.25Y-3N, 1.25Y-3.5

Lead Wire Connection

Caution

Plug lead: Grommet type

Make connections to each corresponding wire.

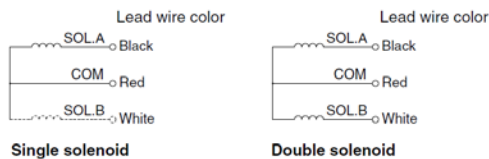

	Single solenoid	Double solenoid
Standard	Black: A side solenoid Red: COM	Black: A side solenoid Red: COM White: B side solenoid
IP65 enclosure	Black: A side solenoid Red: COM White: B side solenoid (Not used for single solenoid) Green: (Not used for single or double.)	

Note) There is no polarity. It can also be used as –COM.

Installation and Removal of Light Cover

Caution

Installation/Removal of light cover (VQ4000)

●Removal

Open the cover by inserting a small flat head screwdriver into the slot on the side of the pilot assembly (see drawing below), lift the cover out about 1 mm and then pull off. If it is pulled off at an angle, the pilot valve may be damaged or the protective O-ring may be scratched.

●Installation

Place the cover straight over the pilot assembly so that the pilot valve is not touched, and push it until the cover hook locks without twisting the protective O-ring. (When pushed in, the hook opens and locks automatically.)

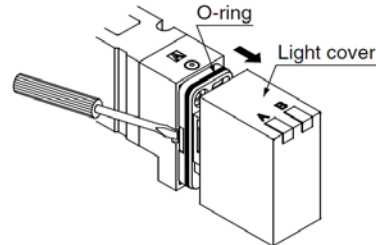

Installation and Removal of Light Cover

Caution

Installation/Removal of light cover (VQ5000)

●Removal

To remove the pilot cover pull it straight off. If it is pulled off at an angle, the pilot valve may be damaged or the protective O-ring may be scratched.

● Installation

Place the cover straight over the pilot assembly so that the pilot valve is not touched, and push it until the cover hook locks without twisting the protective O-ring. (When pushed in, the hook opens and locks automatically.)

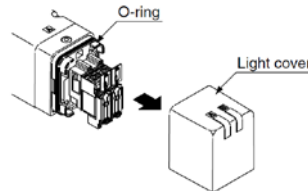

Replacement of Pilot Valve

Caution

● Removal

Remove the mounting screw that holds the pilot valve using a small screwdriver.

● Installation

After confirming the gasket is correctly placed under the valve, securely tighten the bolts with the proper torque shown in the table below.

Proper tightening torque [N·m]
0.1 to 0.13

Note) The light circuit boards: A side is orange and the B side is green. It must be mounted on the pilot valve in accordance with the mounting indicators.

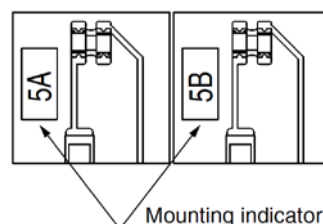



VQ4000/5000 series

Specific Product Precautions 3

Be sure to read this before handling the products.

Plug Lead Type

Attaching and detaching connectors

- To attach a connector, hold the lever and connector unit between your fingers and insert straight onto the pins of the solenoid valve so that the lever's pawl is pushed into the groove and locks.
- To detach a connector, remove the pawl from the groove by pushing the lever downward with your thumb, and pull the connector straight out.

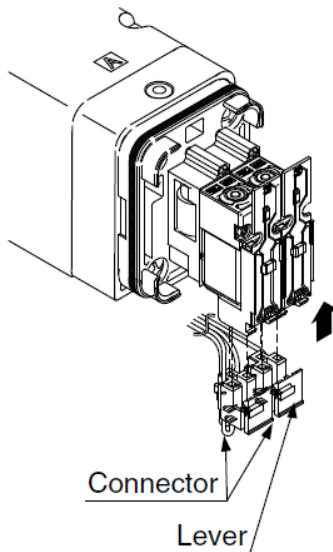

Note) Do not pull on the lead wires with excessive force. This can cause faulty and/or broken contacts.

Internal Wiring Specifications

⚠ Caution

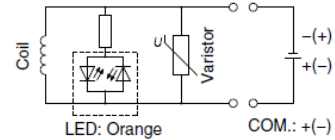

DC: Single

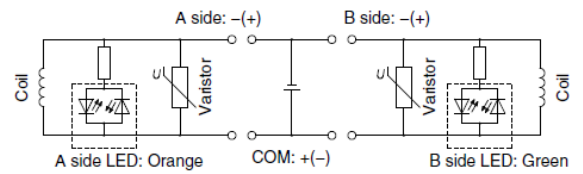

DC: Double

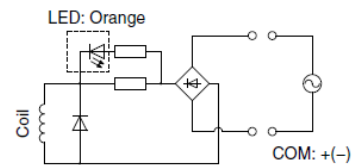

AC: Single

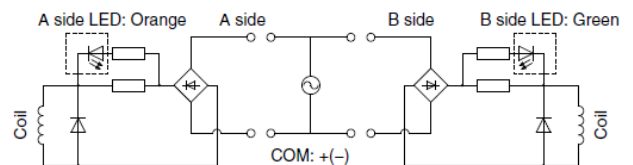

AC: Double

Note) For DC, coil surge voltage generated when OFF is about -60 V. Please contact SMC separately for further suppression of the coil surge voltage.

Enclosure IP65

⚠ Caution

Wires, cables, connectors, etc. used for models conforming to IP65 should also have enclosures equivalent to or stricter rating than IP65.

VQ4000 Series Construction

Plug-in Unit

Metal seal type

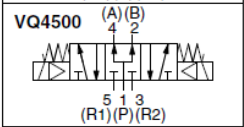
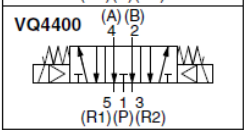
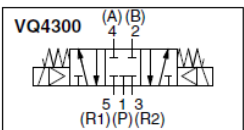
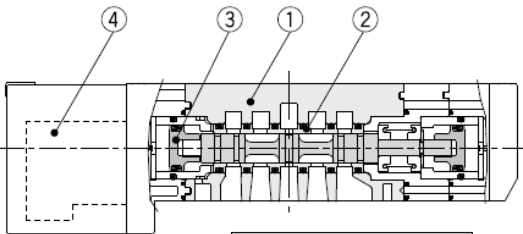
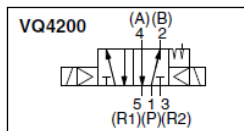
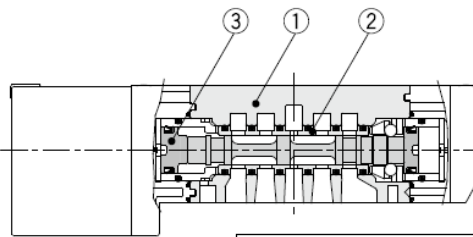
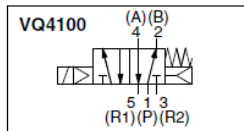
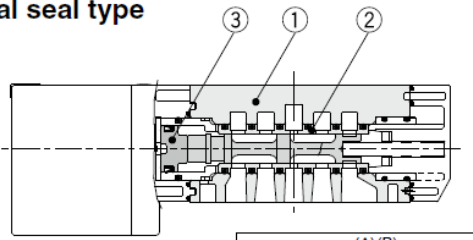

Rubber seal type

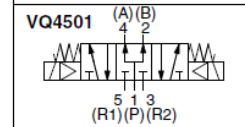
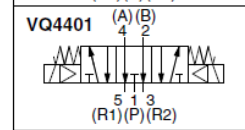
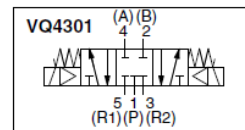
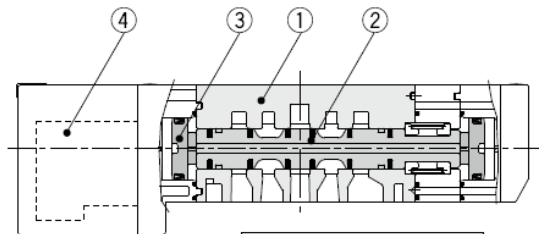
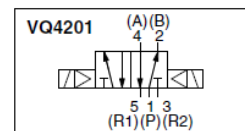
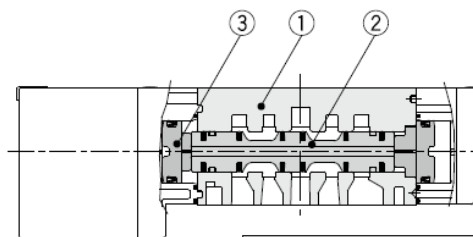
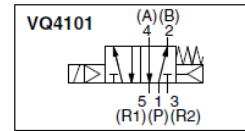
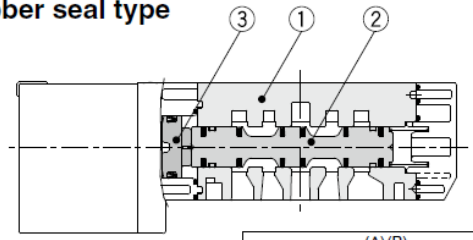

Component Parts

Number	Description	Material	Note
1	Body	Aluminum die-casted	
2	Spool/Sleeve	Stainless steel	
3	Piston	Resin	

Replacement Parts

Number	Description	Part Number	Notes
4	Pilot valve assembly	V118□-□-□-□-□-□ A B E	□: Coil rated voltage Example) 24 VDC: 5 A: Single/With light (For A side) B: Double, 3-position/With light (For B side) E: Single, Double, 3-position/ Without light (A/B side common)
		●Coil type	
		Nil	Standard (0.95 W)
		Y	Low wattage type (0.4 W)

Component Parts

Number	Description	Material	Note
1	Body	Aluminum die-casted	
2	Spool valve	Aluminum, HNBR	
3	Piston	Resin	

Replacement Parts

Number	Description	Part Number	Notes
4	Pilot valve assembly	V118□-□-□-□-□-□ A B E	□: Coil rated voltage Example) 24 VDC: 5 A: Single/With light (For A side) B: Double, 3-position/With light (For B side) E: Single, Double, 3-position/ Without light (A/B side common)
		●Coil type	
		Nil	Standard (0.95 W)
		Y	Low wattage type (0.4 W)

VQ4000 Series Construction

Plug Lead Unit

Metal seal type

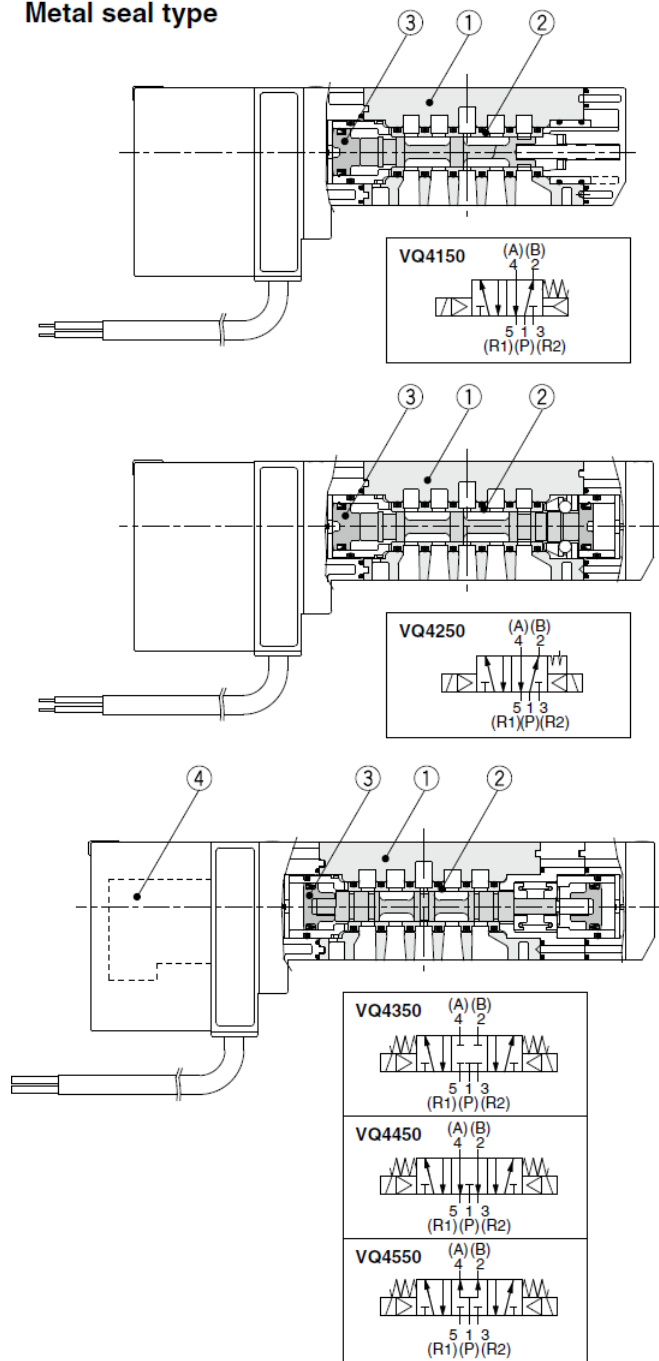

Component Parts

Number	Description	Material	Note
1	Body	Aluminum die-casted	
2	Spool/Sleeve	Stainless steel	
3	Piston	Resin	

Replacement Parts

Number	Description	Coil type		<input type="checkbox"/> Coil rated voltage Example) 24 VDC: 5 A: Single/With light (For A side) B: Double, 3-position/With light (For B side) E: Single, Double, 3-position/ Without light (A/B side common)
		Nil	Standard (0.95W) Low wattage type (0.4W)	
4	Pilot valve assembly	V118 <input type="checkbox"/> A <input type="checkbox"/> B <input type="checkbox"/> E		

Rubber seal type

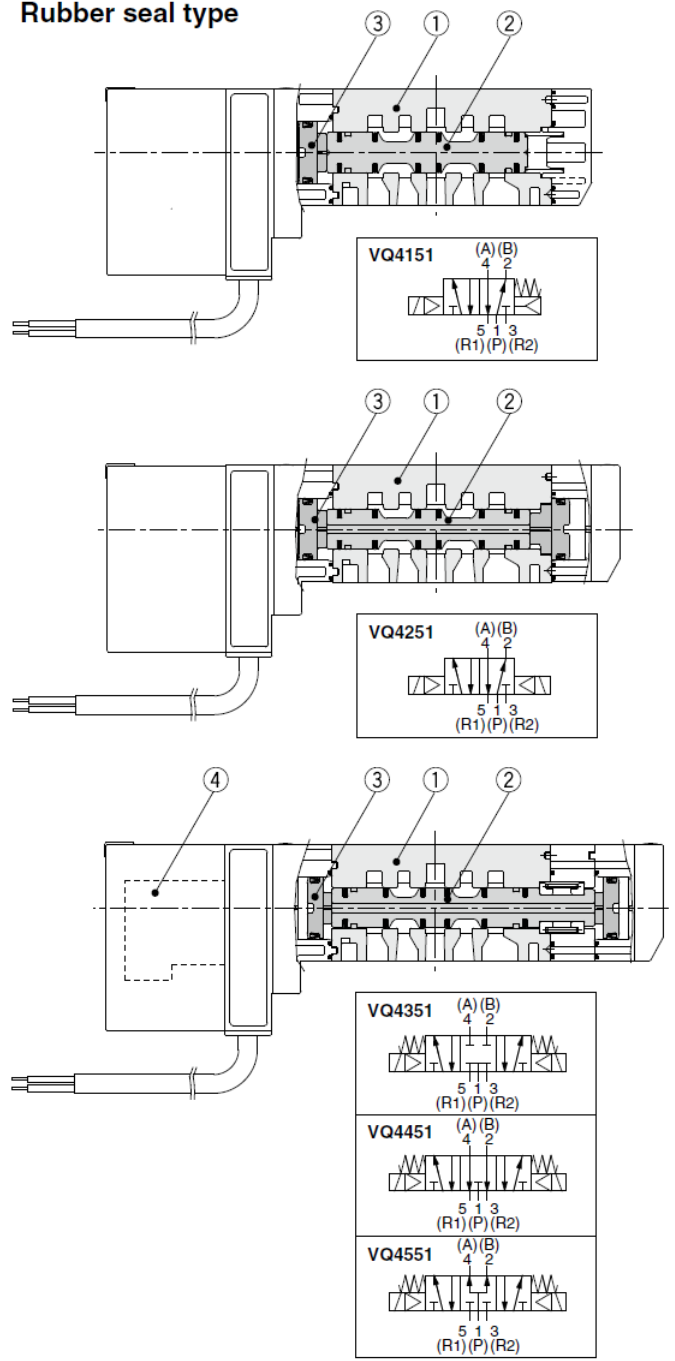

Component Parts

Number	Description	Material	Note
1	Body	Aluminum die-casted	
2	Spool valve	Aluminum, HNBR	
3	Piston	Resin	

Replacement Parts

Number	Description	Coil type		<input type="checkbox"/> Coil rated voltage Example) 24 VDC: 5 A: Single/With light (For A side) B: Double, 3-position/With light (For B side) E: Single, Double, 3-position/ Without light (A/B side common)
		Nil	Standard (0.95W) Low wattage type (0.4W)	
4	Pilot valve assembly	V118 <input type="checkbox"/> A <input type="checkbox"/> B <input type="checkbox"/> E		

VQ5000 Series Construction

Plug-in Unit

Metal seal type

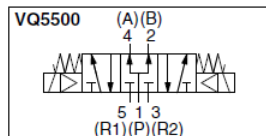
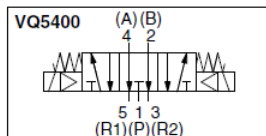
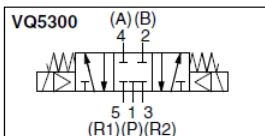
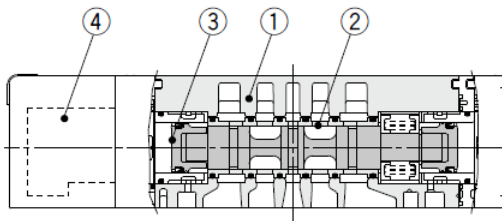
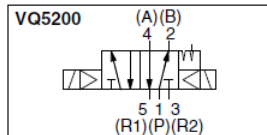
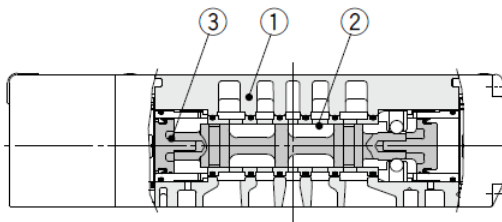
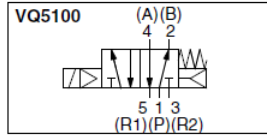
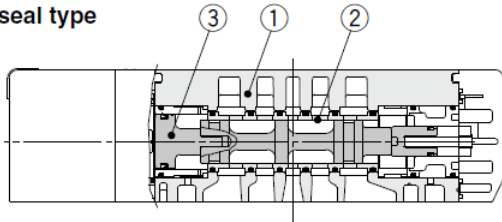

Rubber seal type

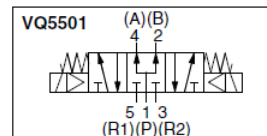
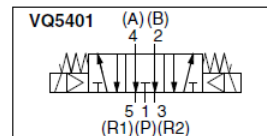
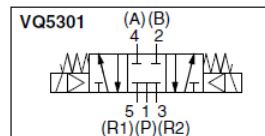
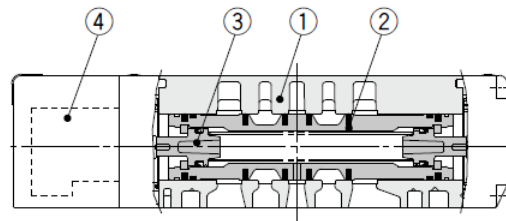
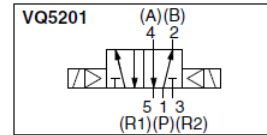
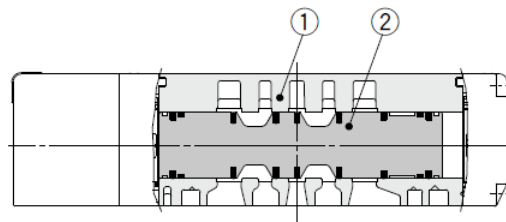
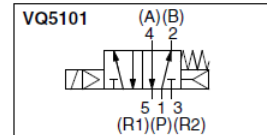
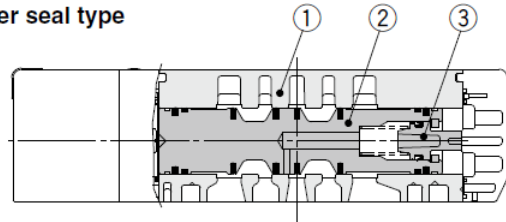

Component Parts

No.	Description	Material	Note
1	Body	Aluminum die-casted	
2	Spool/Sleeve	Stainless steel	
3	Piston	Resin	

Replacement Parts

4	Pilot valve assembly	V118□-□-□-□ A E	<input type="checkbox"/> Coil rated voltage Example) 24 VDC: 5 A: Single/With light (For A side) B: Double, 3-position/With light (For B side) E: Single, Double, 3-position/ Without light (A/B side common)	
		•Coil type <table border="1"> <tr> <td>NH</td> <td>Standard (0.95 W)</td> </tr> <tr> <td>Y</td> <td>Low wattage type (0.4 W)</td> </tr> </table>		NH
NH	Standard (0.95 W)			
Y	Low wattage type (0.4 W)			

Component Parts

No.	Description	Material	Note
1	Body	Aluminum die-casted	
2	Spool valve	Aluminum, HNBR	
3	Piston	Resin	

Replacement Parts

4	Pilot valve assembly	V118□-□-□-□ A E	<input type="checkbox"/> Coil rated voltage Example) 24 VDC: 5 A: Single/With light (For A side) B: Double, 3-position/With light (For B side) E: Single, Double, 3-position/ Without light (A/B side common)	
		•Coil type <table border="1"> <tr> <td>NH</td> <td>Standard (0.95 W)</td> </tr> <tr> <td>Y</td> <td>Low wattage type (0.4 W)</td> </tr> </table>		NH
NH	Standard (0.95 W)			
Y	Low wattage type (0.4 W)			

VQ5000 Series Construction

Plug Lead Unit

Metal seal type

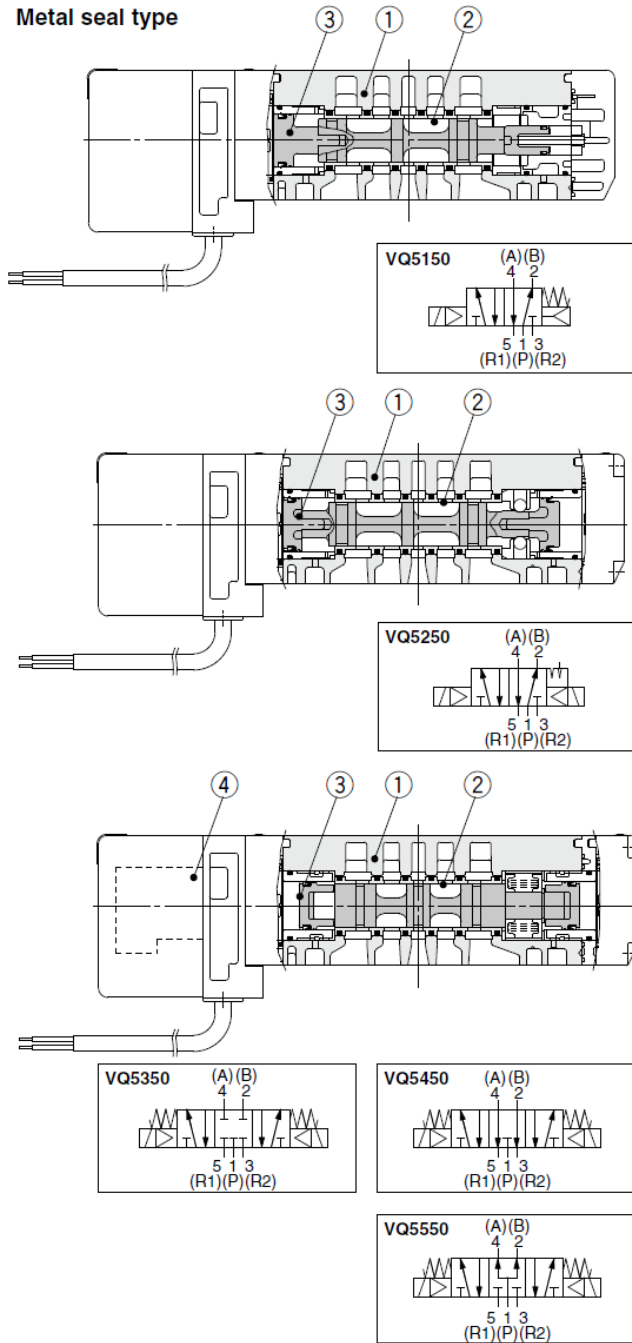

Rubber seal type

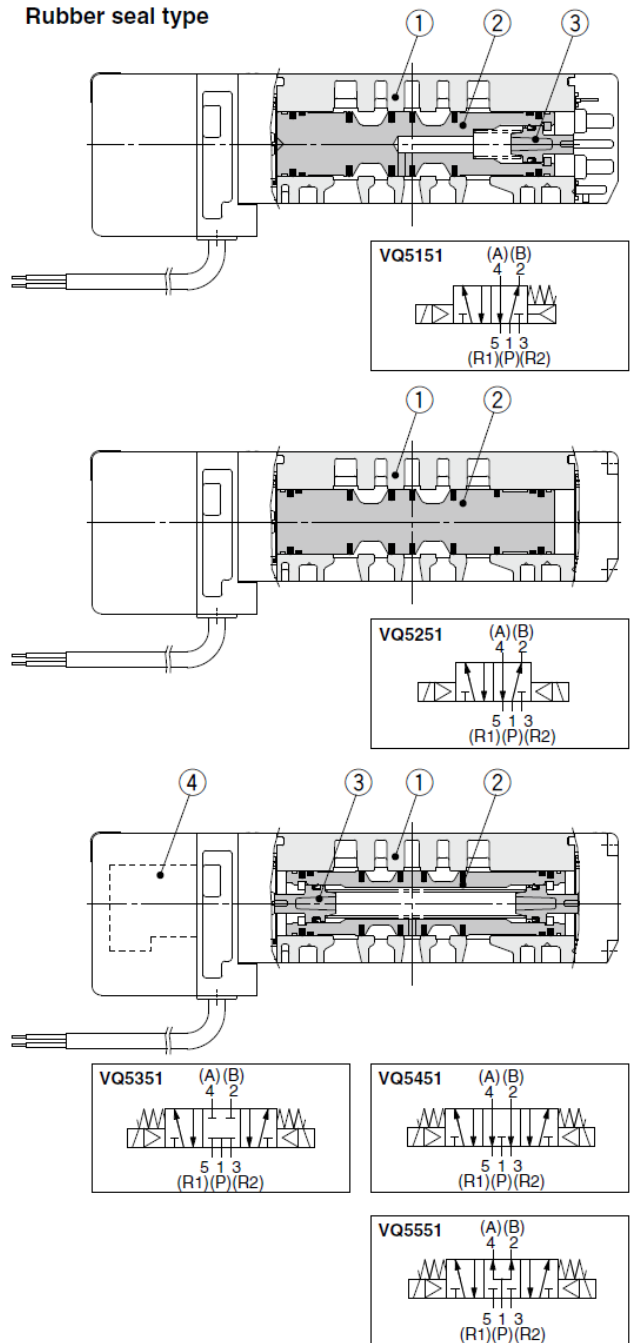

Component Parts

No.	Description	Material	Note
1	Body	Aluminum die-casted	
2	Spool/Sleeve	Stainless steel	
3	Piston	Resin	

Replacement Parts

4	Pilot valve assembly	V118□-□-□-□ A B E	<input type="checkbox"/> : Coil rated voltage Example) 24 VDC: 5 A: Single/With light (For A side) B: Double, 3-position/With light (For B side) E: Single, Double, 3-position/ Without light (A/B side common)	
		•Coil type <table border="1"> <tr> <td>Nil</td> <td>Standard (0.95 W)</td> </tr> <tr> <td>Y</td> <td>Low wattage type (0.4 W)</td> </tr> </table>		Nil
Nil	Standard (0.95 W)			
Y	Low wattage type (0.4 W)			

Component Parts

No.	Description	Material	Note
1	Body	Aluminum die-casted	
2	Spool valve	Aluminum, NBR	
3	Piston	Resin	

Replacement Parts

4	Pilot valve assembly	V118□-□-□-□ A B E	<input type="checkbox"/> : Coil rated voltage Example) 24 VDC: 5 A: Single/With light (For A side) B: Double, 3-position/With light (For B side) E: Single, Double, 3-position/ Without light (A/B side common)	
		•Coil type <table border="1"> <tr> <td>Nil</td> <td>Standard (0.95 W)</td> </tr> <tr> <td>Y</td> <td>Low wattage type (0.4 W)</td> </tr> </table>		Nil
Nil	Standard (0.95 W)			
Y	Low wattage type (0.4 W)			

Problem	For valve failure, take following countermeasure referring to Problem.	Possible causes	Countermeasures
Operation failure Air is not switched.	<pre> graph TD Q1{The valve operate when the manual override button is pushed?} Q2{Indicator LED turns on when the valve is energized?} Q3{YES} Q4{NO} Q5{NO} Q6{YES} Q7{YES} Q8{NO} Q1 -- NO --> C1_1 Q1 -- YES --> Q2 Q2 -- NO --> C1_2 Q2 -- YES --> Q3 Q3 --> C1_3 Q3 --> C1_4 Q3 --> C1_5 Q3 --> C1_6 Q3 --> C1_7 Q3 --> C1_8 Q3 --> C1_9 Q3 --> C1_10 Q3 --> C1_11 Q3 --> C1_12 Q3 --> C1_13 Q3 --> C1_14 Q3 --> C1_15 Q3 --> C1_16 Q3 --> C1_17 Q3 --> C1_18 Q3 --> C1_19 Q3 --> C1_20 Q3 --> C1_21 Q3 --> C1_22 Q3 --> C1_23 Q3 --> C1_24 Q3 --> C1_25 Q3 --> C1_26 Q3 --> C1_27 Q3 --> C1_28 Q3 --> C1_29 Q3 --> C1_30 Q3 --> C1_31 Q3 --> C1_32 Q3 --> C1_33 Q3 --> C1_34 Q3 --> C1_35 Q3 --> C1_36 Q3 --> C1_37 Q3 --> C1_38 Q3 --> C1_39 Q3 --> C1_40 Q3 --> C1_41 Q3 --> C1_42 Q3 --> C1_43 Q3 --> C1_44 Q3 --> C1_45 Q3 --> C1_46 Q3 --> C1_47 Q3 --> C1_48 Q3 --> C1_49 Q3 --> C1_50 Q3 --> C1_51 Q3 --> C1_52 Q3 --> C1_53 Q3 --> C1_54 Q3 --> C1_55 Q3 --> C1_56 Q3 --> C1_57 Q3 --> C1_58 Q3 --> C1_59 Q3 --> C1_60 Q3 --> C1_61 Q3 --> C1_62 Q3 --> C1_63 Q3 --> C1_64 Q3 --> C1_65 Q3 --> C1_66 Q3 --> C1_67 Q3 --> C1_68 Q3 --> C1_69 Q3 --> C1_70 Q3 --> C1_71 Q3 --> C1_72 Q3 --> C1_73 Q3 --> C1_74 Q3 --> C1_75 Q3 --> C1_76 Q3 --> C1_77 Q3 --> C1_78 Q3 --> C1_79 Q3 --> C1_80 Q3 --> C1_81 Q3 --> C1_82 Q3 --> C1_83 Q3 --> C1_84 Q3 --> C1_85 Q3 --> C1_86 Q3 --> C1_87 Q3 --> C1_88 Q3 --> C1_89 Q3 --> C1_90 Q3 --> C1_91 Q3 --> C1_92 Q3 --> C1_93 Q3 --> C1_94 Q3 --> C1_95 Q3 --> C1_96 Q3 --> C1_97 Q3 --> C1_98 Q3 --> C1_99 Q3 --> C1_100 </pre>	1) Sliding failure or sticking of the main valve Foreign matter coming from the air source is caught in the main valve, causing sliding failure or sticking.	<ul style="list-style-type: none"> Replace the valve. Purify the air source.
		2) Decreased pressure Air source pressure is reduced and minimum operating pressure of the valve was not reached.	<ul style="list-style-type: none"> Adjust the pressure within the specification range for the valve.
		1) Non-conformance of electric system <ul style="list-style-type: none"> Incorrect wiring Fuse blown out, breakage of lead wire Incorrect contact at the contact and connection Sequencer non-conformance Supply voltage insufficient 	Check all possible causes and make sure the wiring is correct. Replace the part, if necessary.
		1) Drop of supply voltage Even if the indicator LED turns on, the valve may not operate due to voltage drop.	<ul style="list-style-type: none"> Check the supply voltage. Take corrective action if voltage drop is confirmed.
		2) Leakage current The valve does not switch due to the residual voltage when OFF.	Check the residual voltage. Keep the residual voltage. DC coil : 3% or less of the rated voltage. AC coil : 8% or less of the rated voltage.
3) Failure of the installed pilot valve <ul style="list-style-type: none"> Pilot valve coil breakage Foreign matter is caught in the pilot valve armature. Swelling of the pilot valve poppet Pilot valve coil burnt (High voltage, difference of the coil specifications, entry of water) 	<ul style="list-style-type: none"> Replace the pilot valve assembly. Clean the air supply Check the voltage, and replace the pilot valve assembly. Protect the valve, especially the coil to prevent being exposed to water. 		
Response failure Slow response		1) Leakage current Response delayed due to the residual voltage when the valve is off.	Check the residual voltage. Keep the residual voltage. DC coil : 3% or less of the rated voltage. AC coil : 8% or less of the rated voltage.
		2) Sliding failure or sticking of the main valve. Foreign matter coming from the air source is caught in the main valve, causing sliding failure or sticking.	<ul style="list-style-type: none"> Replace the valve. Clean the air supply
Air leakage	Check the air leakage point 1. Leakage between the valve and base	1-1) Valve mounting screw is loose	Make sure that the gasket of the valve mounting surface is not displaced or deformed before tightening. Appropriate tightening torque <ul style="list-style-type: none"> VQ4000 : 0.8 to 1.2N · m VQ5000 : 1.0 to 1.8N · m If gasket is scratched, replace the gasket.
		1-2) Gasket is caught	Replace the gasket.

Problem	For valve failure, take following countermeasure referring to Problem.	Possible causes	Countermeasures
Air leakage	2. Air leaks from the One-touch fitting.	2-1) Tube is not inserted all the way into the fitting. 2-2) Tube has a gouge 2-3) The cut surface of the tube is slanted.	Check all possible causes and make sure the piping is correct. Replace the part, if necessary.
		2-4) One-touch fitting seal is damaged	Replace One-touch fitting assembly
	3. Air leakage from the exhaust (R) port. Note) Metal seal type has approximately 250cc of leakage per valve set. This is within specification value. (Supply pressure: 0.5 MPa)	3-1) Internal leakage increased because foreign matter coming from the air source is caught in the main valve.	<ul style="list-style-type: none"> • Replace the valve. • Purify the air source.
	4. Air leaks from the manifold	4-1) Loose DIN rail clamp screw	Hold manifolds tightly for tightening so that there is no gap between the valves. Appropriate tightening torque <ul style="list-style-type: none"> • VQ4000 : 0.8 to 1.2N · m • VQ5000 : 1.0 to 1.8N · m

Revision history

1st Printing :Wo

SMC Corporation

4-14-1, Sotokanda, Chiyoda-ku, Tokyo 101-0021 JAPAN
Tel: + 81 3 5207 8249 Fax: +81 3 5298 5362
URL <http://www.smcworld.com>

Note: Specifications are subject to change without prior notice and any obligation on the part of the manufacturer.
© 2017 SMC Corporation All Rights Reserved