



Operation Manual

PRODUCT NAME

3 Position Valve with 3 Ports

MODEL/ Series/ Product Number

VEX3 series
(Mounted pilot valve: V100 / VO307)

SMC Corporation

Contents

Safety Instructions -----	2, 3
Design/Selection -----	4 to 6
Mounting -----	6
Piping -----	6
Wiring -----	7
Lubrication -----	7
Air Supply -----	7
Operating Environment -----	8
Maintenance -----	8
Specific Product Precautions -----	9 to 11
Replacement Parts List -----	12
Troubleshooting -----	13
Countermeasures -----	14



Safety Instructions

These safety instructions are intended to prevent hazardous situations and/or equipment damage. These instructions indicate the level of potential hazard with the labels of “Caution,” “Warning” or “Danger.” They are all important notes for safety and must be followed in addition to International Standards (ISO/IEC)*1), and other safety regulations.

*1) ISO 4414: Pneumatic fluid power -- General rules relating to systems.

ISO 4413: Hydraulic fluid power -- General rules relating to systems.

IEC 60204-1: Safety of machinery -- Electrical equipment of machines .(Part 1: General requirements)

ISO 10218-1992: Manipulating industrial robots -Safety.

etc.



Caution

Caution indicates a hazard with a low level of risk which, if not avoided, could result in minor or moderate injury.



Warning

Warning indicates a hazard with a medium level of risk which, if not avoided, could result in death or serious injury.



Danger

Danger indicates a hazard with a high level of risk which, if not avoided, will result in death or serious injury.

Warning

1. The compatibility of the product is the responsibility of the person who designs the equipment or decides its specifications.

Since the product specified here is used under various operating conditions, its compatibility with specific equipment must be decided by the person who designs the equipment or decides its specifications based on necessary analysis and test results.

The expected performance and safety assurance of the equipment will be the responsibility of the person who has determined its compatibility with the product.

This person should also continuously review all specifications of the product referring to its latest catalog information, with a view to giving due consideration to any possibility of equipment failure when configuring the equipment.

2. Only personnel with appropriate training should operate machinery and equipment.

The product specified here may become unsafe if handled incorrectly.

The assembly, operation and maintenance of machines or equipment including our products must be performed by an operator who is appropriately trained and experienced.

3. Do not service or attempt to remove product and machinery/equipment until safety is confirmed.

1. The inspection and maintenance of machinery/equipment should only be performed after measures to prevent falling or runaway of the driven objects have been confirmed.

2. When the product is to be removed, confirm that the safety measures as mentioned above are implemented and the power from any appropriate source is cut, and read and understand the specific product precautions of all relevant products carefully.

3. Before machinery/equipment is restarted, take measures to prevent unexpected operation and malfunction.

4. Contact SMC beforehand and take special consideration of safety measures if the product is to be used in any of the following conditions.

1. Conditions and environments outside of the given specifications, or use outdoors or in a place exposed to direct sunlight.

2. Installation on equipment in conjunction with atomic energy, railways, air navigation, space, shipping, vehicles, military, medical treatment, combustion and recreation, or equipment in contact with food and beverages, emergency stop circuits, clutch and brake circuits in press applications, safety equipment or other applications unsuitable for the standard specifications described in the product catalog.

3. An application which could have negative effects on people, property, or animals requiring special safety analysis.

4. Use in an interlock circuit, which requires the provision of double interlock for possible failure by using a mechanical protective function, and periodical checks to confirm proper operation.



Safety Instructions

Caution

1. The product is provided for use in manufacturing industries.

The product herein described is basically provided for peaceful use in manufacturing industries.

If considering using the product in other industries, consult SMC beforehand and exchange specifications or a contract if necessary.

If anything is unclear, contact your nearest sales branch.

Limited warranty and Disclaimer/Compliance Requirements

The product used is subject to the following “Limited warranty and Disclaimer” and “Compliance Requirements”.

Read and accept them before using the product.

Limited warranty and Disclaimer

1. The warranty period of the product is 1 year in service or 1.5 years after the product is delivered, whichever is first.*2)

Also, the product may have specified durability, running distance or replacement parts. Please consult your nearest sales branch.

2. For any failure or damage reported within the warranty period which is clearly our responsibility, a replacement product or necessary parts will be provided.

This limited warranty applies only to our product independently, and not to any other damage incurred due to the failure of the product.

3. Prior to using SMC products, please read and understand the warranty terms and disclaimers noted in the specified catalog for the particular products.

***2) Vacuum pads are excluded from this 1 year warranty.**

A vacuum pad is a consumable part, so it is warranted for a year after it is delivered.

Also, even within the warranty period, the wear of a product due to the use of the vacuum pad or failure due to the deterioration of rubber material are not covered by the limited warranty.

Compliance Requirements

1. The use of SMC products with production equipment for the manufacture of weapons of mass destruction (WMD) or any other weapon is strictly prohibited.

2. The exports of SMC products or technology from one country to another are governed by the relevant security laws and regulation of the countries involved in the transaction. Prior to the shipment of a SMC product to another country, assure that all local rules governing that export are known and followed.



VEX3 Series

3 position valve with 3 ports / Precautions (1)

Be sure to read before handling.

Design/Selection

Warning

1. Confirm the specifications.

This product is designed only for use in compressed air systems including vacuum.

Do not operate at pressures or temperatures, etc., beyond the range of specifications, as this can cause damage or malfunction. (Refer to the specifications.)

Please contact SMC when using a fluid other than compressed air (including vacuum).

We do not guarantee against any damage if the product is used outside of the specification range.

2. Actuator drive

When an actuator, such as a cylinder, is to be driven using a valve, take appropriate measures (cover installation or approach prohibition) to prevent potential danger caused by actuator operation.

3. Intermediate stops

Due to the compressibility of air, it is difficult for this product to make a piston stop at the required intermediate position accurately and precisely.

Furthermore, since valves and cylinders are not guaranteed for zero air leakage, it may not be possible to hold a stopped position for an extended period of time.

Please contact SMC if it is necessary to hold a stopped position for an extended period of time.

4. Effect of back pressure when using a manifold

Use caution when valves are used on a manifold, because an actuator may malfunction due to back-pressure.

5. Holding pressure (including vacuum)

Since the valves are subject to air leakage, they cannot be used for applications such as holding pressure (including vacuum) in a pressure vessel.

6. Not suitable for use as an emergency shutoff valve, etc.

This product is not designed for safety applications such as an emergency shutoff valve. If the valves are used for the mentioned applications, additional safety measures should be adopted.

7. Release of residual pressure

For maintenance purposes install a system for releasing residual pressure.

Ensure that the residual pressure between the valve and the cylinder is released.

8. Operation in a vacuum condition

When a valve is used for switching a vacuum, take measures to install a suction filter or similar to prevent external dust or other foreign matter from entering inside the valve.

In addition, at the time of vacuum adsorption, be sure to vacuum at all times. Failure to do so may result in foreign matter sticking to the adsorption pad, or air leakage causing the workpiece to drop.

9. Use of the VEX3 series solenoid type product

When using the VEX3 series solenoid type for the first time, actuators may travel in an unexpected direction depending on the switching position of the valve. Implement measures to prevent any danger from occurring when operating the actuator.

10. Ventilation

Provide ventilation when using a valve in a confined area, such as in a closed control panel. For example, install a ventilation opening, etc. in order to prevent pressure from increasing inside of the confined area and to release the heat generated by the valve.

11. Extended periods of continuous energization

- If a valve will be continuously energized for an extended period of time, the temperature of the valve will increase due to the heat generated by the coil. This will likely adversely affect the performance of the solenoid valve and any nearby peripheral equipment. Therefore, when it is continuously energized for an extended period of time or when the energized period per day is longer than the de-energized period, use VEX3 air operated type product. For pilot air operation, use a low-wattage type or continuous duty type valve.

As a valve not mentioned above can also be used depending on the operating conditions (in particular, DC specification valves), please contact SMC for further information.

- For applications such as mounting a valve on a control panel, incorporate measure to limit the heat radiation so that it is within the operating temperature range. Do not touch the valves by bare hand during or after energization.

In particular, note that the temperature rise will be greater if the product is energized for extended periods of time.

12. Do not disassemble the product or make any modifications, including additional machining.

It may cause human injury and/or an accident.



VEX3 Series

3 position valve with 3 ports / Precautions (2)

Be sure to read before handling.

Design/Selection

Caution

1. Leakage voltage

Take note that the leakage voltage will increase when a resistor is used in parallel with switching element or a C-R circuit (surge voltage suppressor) is used for protecting a switching device because of the passing leakage voltage through the C-R circuit. The suppressor residual leakage voltage should be as follows.

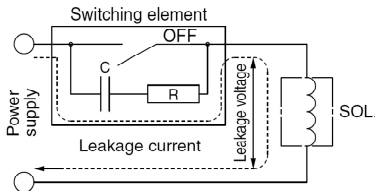

DC coil

3% or less of rated voltage

AC coil

- VEX3121, VEX3122, VEX3221, VEX3222 } 8% or less of rated voltage
- VEX3321, VEX3322, VEX3421, VEX3422 }
- VEX3501, VEX3701, VEX3901 } 15% or less of rated voltage

2. Solenoid valve drive for AC with a solid state output (SSR, TRIAC output, etc.)

1) Current leakage

When using a snubber circuit (C-R element) for surge protection of the output, a very small amount of electrical current will continue to flow even during the OFF state. This results in the valve not returning. In a situation where the tolerance is exceeded, as in the above case, take measures to install a bleeder resistor.

2) Minimum allowable load amount (Min. load current)

When the consumption current of a valve is less than the output's minimum allowable load volume or the margin is small, the output may not switch normally. Please contact SMC.

3) Solenoid valve with full wave rectifier circuit

When the solenoid valve built-in full wave rectifier circuit with the AC specifications is used, the solenoid valve return failure may occur depending on the kind of the triac output circuit. Carefully check this point when selecting a SSR or sequencer. For details, contact the SSR or sequencer manufacturer.

3. Surge voltage suppressor

- 1) A surge voltage suppressor built into the valve is intended to protect the output contacts so that the surge generated inside valve does not adversely affect the output contacts. Therefore, if an overvoltage or overcurrent is received from an external peripheral device, the surge voltage protection element inside the valve is overloaded, causing the element to break. In the worst case, the electric circuit enters the short-circuit status by the breakage. If the energizing continues in this status, a large current flows. This may cause secondary damage to the output circuit, external peripheral device, or valve, and may also cause fire accident. So, take appropriate protective measures, such as installation of an overcurrent protection circuit in the power supply or drive circuit to maintain the sufficient safety.

- 2) If a surge protection circuit contains nonstandard diodes, such as Zener diodes or varistor, a residual voltage that is in proportion to the protective circuit and the rated voltage will remain. Therefore, take into consideration the surge voltage protection of the controller.

In the case of diodes, the residual voltage is approximately 1V.

4. Surge voltage intrusion

(For VEX3121, VEX3221, VEX3321, and VEX3421)

With non-polar type solenoid valves, at times of sudden interruption of the loading power supply, such as emergency shutdown, surge voltage intrusion may be generated from loading equipment with a large capacity (power consumption), and the solenoid valve in a deenergized state may switch over (see Figure 1).

When installing a breaker circuit for the loading power supply, consider using a solenoid valve with polarity (with polarity protection diode), or install a surge absorption diode between the loading equipment COM line and the output equipment COM line (see Figure 2).

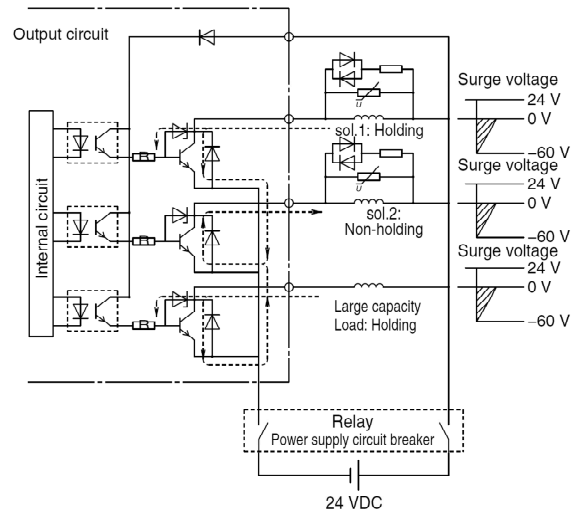

Figure 1. Surge intrusion circuit example (NPN outlet example)

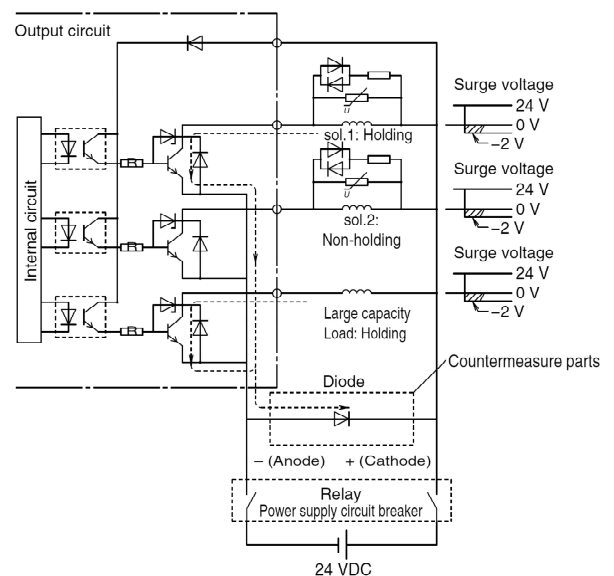

Figure 2. Surge intrusion circuit example (NPN outlet example)



VEX3 Series

3 position valve with 3 ports / Precautions (3)

Be sure to read before handling.

Design/Selection

⚠ Caution

5. Operation in a low temperature condition

Take appropriate measures to avoid freezing of drainage, moisture etc. in low temperature.

The minimum operating temperature for this product is 0°C.

6. Operation for air blowing

When using a solenoid valve for air blowing, use an external pilot type.

Use caution because the pressure drop caused by the air blowing can have an affect on the internal pilot type valve when the internal pilot type valves and external pilot type valves are used on the same manifold.

7. Mounting orientation

Mounting orientation is not specified.

8. Initial lubrication of main valve

Grease has been applied to the main valve as initial lubricant.

Mounting

⚠ Warning

1. Operation Manual (this copy)

Install the products and operate them only after reading the operation manual carefully and understanding its contents. Also, keep the manual where it can be referred to as necessary.

2. Ensure sufficient space for maintenance activities.

When installing the products, allow access for maintenance.

3. Tighten threads with the proper tightening torque.

When installing the products, follow the listed torque specifications.

4. If air leakage increases or equipment does not operate properly, stop operation.

Check mounting conditions when air and power supplies are connected. Initial function and leakage tests should be performed after installation.

5. Painting and coating

Warnings or specifications printed or affixed to the product should not be erased, removed or covered up.

Please consult with SMC before applying paint to resinous parts, as this may have an adverse effect due to the solvent in the paint.

Piping

⚠ Caution

1. Preparation before piping

Before piping is connected, it should be thoroughly blown out with air (flushing) or washed to remove chips, cutting oil and other debris from inside the pipe.

2. Wrapping of pipe tape

When screwing piping or fittings into ports, ensure that chips from the pipe threads or sealing material do not enter the piping.

Also, if pipe tape is used, leave 1 thread ridge exposed at the end of the threads.

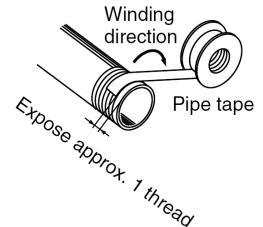

3. After piping

Check the piping to prevent air leakage from the piping between the valve and the cylinder.

4. Connection of pipings and fittings

When screwing the piping or fitting into the valve, tighten it as follows.

1) When using SMC fitting, follow the procedures below to tighten it.

•M5

First, tighten by hand, then use a wrench appropriate for the hexagon flats of the body to tighten an additional 1/6 to 1/4 turn. A reference value for the tightening torque is 1 to 1.5 N·m.

Note) Excessive tightening may damage the thread portion or deform the gasket and cause air leakage.

Insufficient tightening may loosen the threads, or cause air leakage.

•When using a fitting other than SMC fitting, follow the instructions given by relevant fitting manufacturer.

2) For the fitting with sealant R or NPT, first, tighten it by hand, then use a wrench appropriate for the hexagon flats of the body to tighten it a further two or three turns. For a tightening torque guide, refer to the table below.

Connection thread size (R, NPT)	Proper tightening torque (N·m)
1/8	3~5
1/4	8~12
3/8	15~20
1/2	20~25
3/4	28~30
1	36~38
1 1/4	40~42
1 1/2	48~50
2	48~50

3) If the fitting is tightened with excessive torque, a large amount of sealant will seep out. Remove the excess sealant.

4) Insufficient tightening may cause seal failure, or loosen the threads.

5. Piping to products

When piping to a product, refer to its instruction manual to avoid connection of the air lines to the incorrect ports.



VEX3 Series

3 position valve with 3 ports / Precautions (4)

Be sure to read before handling.

Wiring

Warning

The solenoid valve is an electrical product. For safety, install an appropriate fuse and circuit breaker before use.

Caution

1. Polarity

When connecting power to a solenoid valve with a DC specification and equipped with a light or surge voltage suppressor, check for polarity.

If a mistake is made regarding the polarity, damage may occur to the diode in the valve, the switching element in a control device or power supply equipment, etc.

2. Applied voltage

When electric power is connected to a solenoid valve, be careful to apply the proper voltage. Improper voltage may cause malfunction or coil damage.

3. Check the connections.

Check if the connections are correct after completing all wiring.

4. External force applied to lead wire

If an excessive force is applied to the lead wire, this may cause faulty wiring. Take appropriate measures so that a force of 20 N or more is not applied to the lead wire.

Lubrication

Warning

1. Lubrication

1) The product has been lubricated by the manufacturer, and does not require lubrication maintenance.

2) If a lubricant is used in the system, use class 1 turbine oil (no additive), ISO VG32. For details about lubricant manufacturers' brands, refer to SMC website. Additionally, please contact SMC for details about class 2 turbine oil (with additives) ISO VG32.

Once lubricant is utilized within the system, since the original lubricant applied within the product during manufacturing will be washed away, please continue to supply lubrication to the system. Without continued lubrication, malfunctions could occur.

2. Lubrication amount

If the lubrication amount is excessive, the oil may accumulate inside the pilot valve, causing malfunction or response delay. So, do not apply a large amount of oil. When a large amount of oil needs to be applied, use an external pilot type to put the supply air on the pilot valve side in the non-lube state. This prevents accumulation of oil inside the pilot valve.

Air Supply

Warning

1. Type of fluids

Please consult with SMC when using the product in applications other than compressed air.

2. When there is a large amount of drainage.

Compressed air containing a large amount of drainage can cause malfunction of pneumatic equipment. An air dryer or water separator should be installed upstream from filters.

3. Drain flushing

If condensation in the drain bowl is not emptied on a regular basis, the bowl will overflow and This may cause malfunction of pneumatic equipment.

If the drain bowl is difficult to check and remove, installation of a drain bowl with an auto drain option is recommended.

For compressed air quality, refer to SMC Best Pneumatics catalog.

4. Use clean air.

Do not use compressed air that contains chemicals, synthetic oils including organic solvents, salt or corrosive gases, etc., as it can cause damage or malfunction.

Caution

1. When extremely dry air is used as the fluid, degradation of the lubrication properties inside the equipment may occur, resulting in reduced reliability (or reduced service life) of the equipment. Please consult with SMC.

2. Take measures to ensure air quality, such as by installing an aftercooler, air dryer, or water separator.

Compressed air that contains a large amount of drainage can cause malfunction of pneumatic equipment such as valves.

Therefore, take appropriate measures to ensure air quality, such as by providing an aftercooler, air dryer, or water separator.

3. As a countermeasure, install an air filter and a mist separator on the upstream side of the valve.

If the supply side pressure line contains drain or foreign matter, the sliding resistance of the moving part will increase, resulting in a malfunction. In addition, if excessive carbon dust is generated by the compressor, it may adhere to the inside of the valve and cause it to malfunction. To avoid the malfunction shown above, install an air filter and a mist separator on the upstream side of the valve.

For compressed air quality, refer to SMC Best Pneumatics catalog.



VEX3 Series

3 position valve with 3 ports / Precautions (5)

Be sure to read before handling.

Operating Environment

Warning

1. Do not use in an atmosphere having corrosive gases, chemicals, sea water, water, water steam, or where there is direct contact with any of these.
2. Do not use in an environment where flammable gas or explosive gas exists. Usage may cause a fire or explosion. The products do not have an explosion proof construction.
3. Do not use in a place subject to heavy vibration and/or shock.
4. The valve should not be exposed to prolonged sunlight. Use a protective cover. Note that the valve is not for outdoor use.
5. Remove any sources of excessive heat.
6. If it is used in an environment where there is possible contact with oil, weld spatter, etc., exercise preventive measures.
7. When the solenoid valve is mounted in a control panel or its energized for a long time, make sure ambient temperature is within the specification of the valve.

Caution

1. Temperature of ambient environment

Use the valve within the range of the ambient temperature specification of each valve. In addition, pay attention when using the valve in environments where the temperature changes drastically.

2. Humidity of ambient environment

- When using the valve in environments with low humidity, take measures to prevent static.
- If the humidity rises, take measures to prevent the adhesion of water droplets on the valve.

Maintenance

Warning

1. Maintenance should be performed according to the procedure indicated in the Operation Manual (this copy).

If handled improperly, malfunction and damage of machinery or equipment may occur.

2. Removal of equipment, and supply/exhaust of compressed air

When equipment is removed, first confirm that measures are in place to prevent workpieces from dropping, run-away equipment, etc. Then, cut off the supply air and electric power, and exhaust all compressed air from the system using its residual pressure release function.

For this product, exhaust the residual pressure between the valve and the cylinder.

When the equipment is operated after remounting or replacement, first confirm that measures are in place to prevent lurching of actuators, etc. Then, confirm that the equipment is operating normally.

3. Low frequency operation

Valves should be operated at least once every 30 days to prevent malfunction. (Use caution regarding the air supply.)

4. Manual override

When the manual override is operated, connected equipment will be actuated.

Operate after safety is confirmed.

5. If the volume of air leakage increases or the valve does not operate normally, do not use the valve. Perform periodic maintenance of the valve to confirm the operating condition, and if there is any air leakage.

Caution

1. Drain flushing

Remove drainage from the air filters regularly. (Refer to the specifications.)

2. Lubrication

Once lubrication has been started, it must be continued.

Use class 1 turbine oil (with no additive), VG32. If other lubricant oil is used, it may cause malfunction. Please contact SMC for suggested class 2 turbine oil (with additive), VG32.



VEX3 Series

Specific Product Precautions (1)

Be sure to read before handling.

Connectors for Series VEX3 Body Sizes 12, 22, 32, 42

How to Use Plug Connector

Caution

1. Attaching and detaching connectors

- To attach a connector, hold the lever and connector unit between your fingers and insert straight onto the pins of the solenoid valve so that the lever's pawl is pushed into the groove and locks.
- To detach a connector, remove the pawl from the groove by pushing the lever downward with your thumb, and pull the connector straight out.

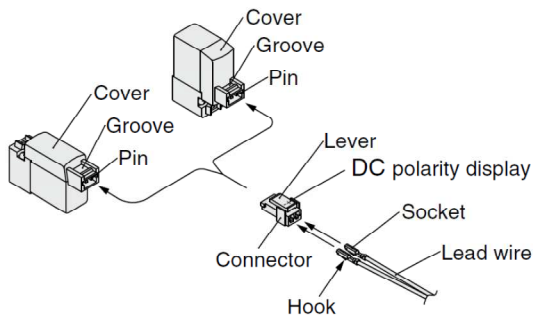

2. Crimping of lead wires and sockets

Strip 3.2 to 3.7 mm at the end of the lead wires, insert the ends of the core wires evenly into the sockets, and then crimp with a crimping tool. When this is done, take care that the coverings of the lead wires do not enter the core wire crimping area.

Use an exclusive crimping tool for crimping.
(Contact SMC for special crimping tools.)

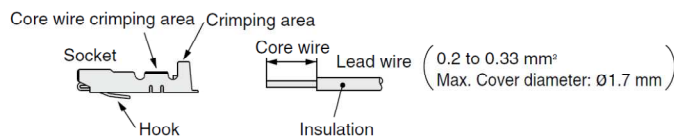

3. Attaching and detaching sockets with lead wires

• Attaching

Insert the sockets into the square holes of the connector (+, - indication), and continue to push the sockets all the way in until they lock by hooking into the seats in the connector.

(When they are pushed in, their hooks open and they are locked automatically.) Then confirm that they are locked by pulling lightly on the lead wires.

• Detaching

To detach a socket from a connector, pull out the lead wire while pressing the socket's hook with a stick having a thin tip (approx. 1 mm). If the socket will be used again, first spread the hook outward.

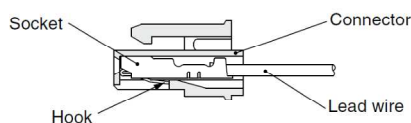

Plug Connector Lead Wire Length

Standard length is 300 mm, but the following lengths are also available.

How to Order Connector Assembly

For DC : SY100-30-4A-□
 For 100 VAC : SY100-30-1A-□
 For 200 VAC : SY100-30-2A-□
 For other voltages of AC : SY100-30-3A-□
 Without lead wire : SY100-30-A
 (with connector and 2 of sockets only)

Lead wire length	
Nil	300 mm
6	600 mm
10	1000 mm
15	1500 mm
20	2000 mm
25	2500 mm
30	3000 mm
50	5000 mm

How to Order

Include the connector assembly part number together with the part number for the plug connector's solenoid valve without connector.

Ex.) In case of 2000 mm of lead wire

For DC	For AC
VEX3122-015LO1	VEX3122-011LO1
SY100-30-4A-20	SY100-30-1A-20

Connector Assembly with Cover

Connector assembly with dust proof protective cover.

- Effective to prevention of short circuit failure due to the entry of foreign matter into the connector.
- Chloroprene rubber for electrical use, which provides outstanding weather resistance and electrical insulation, is used for the cover material. However, do not allow contact with cutting oil, etc.
- Simple and unencumbered appearance by adopting roundshaped cord.

How to Order

SY100-68-A-□

Lead wire length

Nil	300 mm
6	600 mm
10	1000 mm
15	1500 mm
20	2000 mm
25	2500 mm
30	3000 mm
50	5000 mm

Connector Assembly with Cover: Dimensions

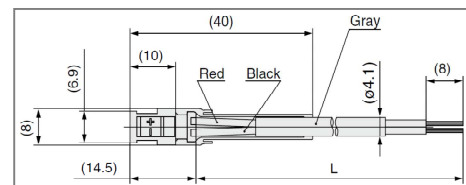

How to Order

Enter the part number for a plug connector solenoid valve without connector together with the part number for a connector assembly with cover.

Ex.) Lead wire length of 2000 mm

VEX3122-015LO1
SY100-68-A-20



VEX3 Series

Specific Product Precautions (2)

Be sure to read before handling.

Connectors for Series VEX3 Body Sizes 12, 22, 32, 42

Surge Voltage Suppressor

Caution

For DC

Polarity (positive and negative) does not matter.

Grommet, L/M Plug Connector

With surge voltage suppressor (□R)

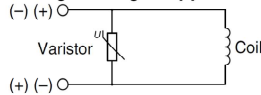

With light/surge voltage suppressor (□U)

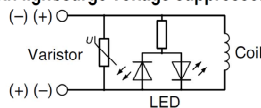

DIN Terminal

With surge voltage suppressor (DS)

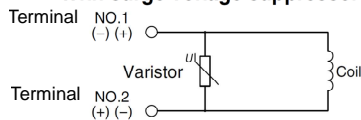

With light/surge voltage suppressor (DZ)

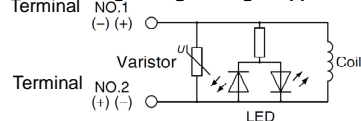

For AC

- There is no "S" type because the generation of surge voltage is prevented by a rectifier.
- Surge voltage suppressor of varistor has residual voltage corresponding to the protective element and rated voltage; therefore, protect the controller side from the surge. The residual voltage of the diode is approximately 1 V.

Grommet, L/M Plug Connector

With light/surge voltage suppressor (□Z)

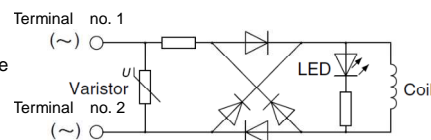

DIN Terminal

With light/surge voltage suppressor (□Z)

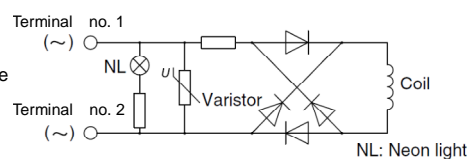

How to Use DIN Terminal

Caution

• Connection

1. Loosen the holding screw (1) and pull the connector out of the solenoid valve terminal block.
2. After removing the holding screw (1), insert a flat head screwdriver, etc. into the notch (2) on the bottom of the terminal block and pry it open, separating the terminal block (2) and the housing.
3. Loosen the terminal screws (slotted screws) (4) on the terminal block (2), insert the cores of the lead wires into the terminals according to the connection method, and fasten them securely with the terminal screws (4).
4. Secure the cord by fastening the ground nut (5).

*When making connections, take note that using other than the supported size ($\varnothing 3.5$ to $\varnothing 7$) heavy duty cord will not satisfy IP65 (enclosure) standards.

Also, be sure to tighten the ground nut (5) and holding screw (1) within their specified torque ranges.

• Changing the entry direction

After separating the terminal block (2) and housing (3), the cord entry can be changed by attaching the housing (3) in the desired direction (4 directions at 90° intervals).

*When equipped with a light, be careful not to damage the light with the cord's lead wires.

• Precautions

Plug in and pull out the connector vertically without tilting to one side.

• Compatible cable

Cord O.D.: $\varnothing 3.5$ to $\varnothing 7$

(Reference) 0.5 mm², 2-core or 3-core, equivalent to JIS C 3306

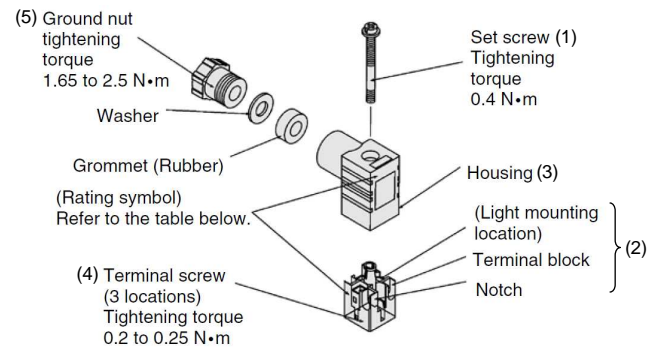

• DIN Connector Part No.

- Without light : SY100-61-1
- With light

Rated voltage	Voltage symbol	Part no.
24 VDC	24V	SY100-61-3-05
12 VDC	12V	SY100-61-3-06
100 VAC	100V	SY100-61-2-01
200 VAC	200V	SY100-61-2-02
110 VAC	110V	SY100-61-2-03
220 VAC	220V	SY100-61-2-04

• Circuit Diagram with Light

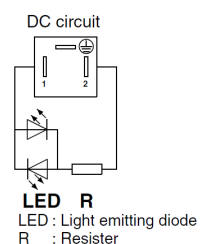
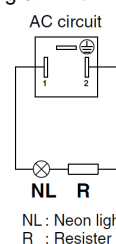



VEX3 Series

Specific Product Precautions (3)

Be sure to read before handling.

Connectors for Series VEX3 Body Sizes 50, 70, 90

How to Use DIN Terminal

⚠ Caution

Disassembly

- 1) After loosening the screw (1), then if the housing (2) is pulled in the direction of the screw (1), the connector will be removed from the body of equipment (solenoid, etc.).
- 2) Pull the screw (1) out of the housing (2).
- 3) On the bottom part of the terminal block (3), there's a cut-off part (9). If a small flat head screwdriver is inserted between the opening in the bottom, terminal block (3) will be removed from the housing (2).
- 4) Remove the cable gland (4), plain washer (5) and rubber seal (6).

Wiring

- 1) Pass the cable (7) through the cable gland (4), plain washer (5) and rubber seal (6) in this order, and then insert them into the housing (2).
- 2) Loosen the screw (11) attached to the terminal block (3). Then, pass the lead wire (10) through the terminal block (3) and tighten the screw (11) again.
 Note 1) Tighten within the tightening torque of $0.5 \text{ Nm} \pm 15\%$.
 Note 2) Cable (7) outside diameter: $\phi 6$ to $\phi 8$ mm
 Note 3) Crimped terminal like round-shape or Y-shape cannot be used.

Assembly

- 1) Pass the cable (7) through the cable gland (4), plain washer (5) and rubber seal (6) in this order and connect to the terminal block (3). Then, mount the terminal block (3) on the housing (2). (Push it down until you hear the click sound.)
- 2) Put the rubber seal (6) and plain washer (5) in this order into the cable entry of the housing (2), and then tighten the cable gland (4) securely.
- 3) Insert the gasket (8) between the bottom part of terminal block (3) and the plug attached to the equipment. Then, screw in (1) from the top of the housing (2) to tighten it.
 Note 1) Tighten within the tightening torque of $0.5 \text{ Nm} \pm 20\%$.

Changing the entry direction

The orientation of a connector can be changed 180° , depending on the combination of a housing (2) and a terminal block (3).

Connector for DIN Terminal

Description	Part no.
DIN connector	B1B09-2A (Standard)
	GM209NJ-B17 (CE-compliant)

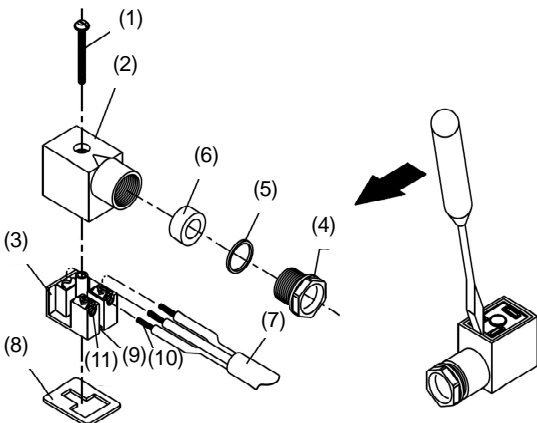

Electrical Connection(DIN Terminal)

⚠ Caution

DIN terminal is connected inside as in the figure below. Connect to the corresponding power supply.

DIN terminal block

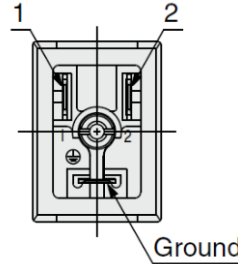

Terminal no.	1	2
DIN terminal	+	-

- Applicable cable O.D.
 $\phi 6$ to $\phi 8$

Lead Wire Color (Grommet)

⚠ Caution

Voltage	Color
100 VAC	Blue
200 VAC	Red
DC	Red (+), Black (-)
Others	Gray

Light/Surge Voltage Suppressor

⚠ Caution

AC

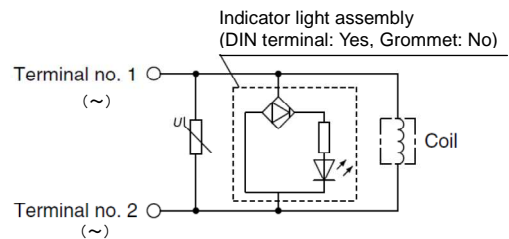

DC

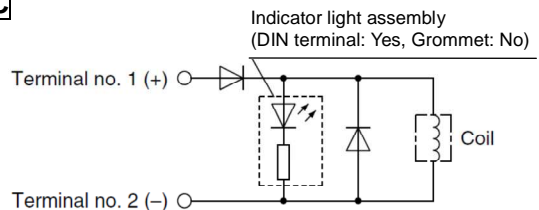

Replacement Parts List

Description	VEX312□- ⁰¹ ₀₂	VEX322□- ⁰¹ ₀₂	VEX332□- ⁰² ₀₃ ⁰⁴	VEX342□- ⁰² ₀₃ ⁰⁴	VEX350□- ⁰⁴ ₀₆ ¹⁰	VEX370□- ¹⁰ ₁₂	VEX390□- ¹⁴ ₂₀
Bracket (with bolt and washer)	VEX1-18-1A	-	-	-	VEX5-32A	VEX7-32A	VEX9-32A
Foot bracket (with bolt and washer)	VEX1-18-2A	-	VEX3-32-2A	-	-	-	-
Silencer for pilot exhaust port (PE) <small>Note 1)</small>	AN120-M5		AN103-01		AN210-02		
Sub plate	-	VEX1-9-2 (1) (2)	-	VEX4-2A-1 (1) (2)	-	-	-
Base gasket	-	VEX1-11-2	-	VEX4-4	-	-	-
Function plate between pilot valve and cover (with gasket)	-	-	-	-	DXT152-14-1A		
Pilot valve <small>Note 2)</small>	Grommet L-connector M-connector	V114□-□□□□			VO307K-□□□1		
	DIN terminal	V115□-□□□					

Note 1) For solenoid valve only.

Note 2) Refer to SMC catalog for pilot valve part numbers.

* Refer to page 9 to 11 for the connector part numbers.

* Screw tightening torque VO307K: 1.35 to 1.45 Nm

V11⁴₅ □: 0.14 to 0.17 Nm

Parts for manifold

Description	VVEX2	VVEX4
Blanking plate assembly (with bracket and mounting screws)	VEX1-17-3A	VEX4-5-3A

Select the symbols from the table below for (1) and (2).

Symbol	(1) Port size		(2) Thread type	
	Port size		Symbol	Thread type
	VEX322□	VEX342□	Nil	Rc
A	1/8	1/4	F	G
B	1/4	3/8	N	NPT
C	-	1/2	T	NPTF

Troubleshooting

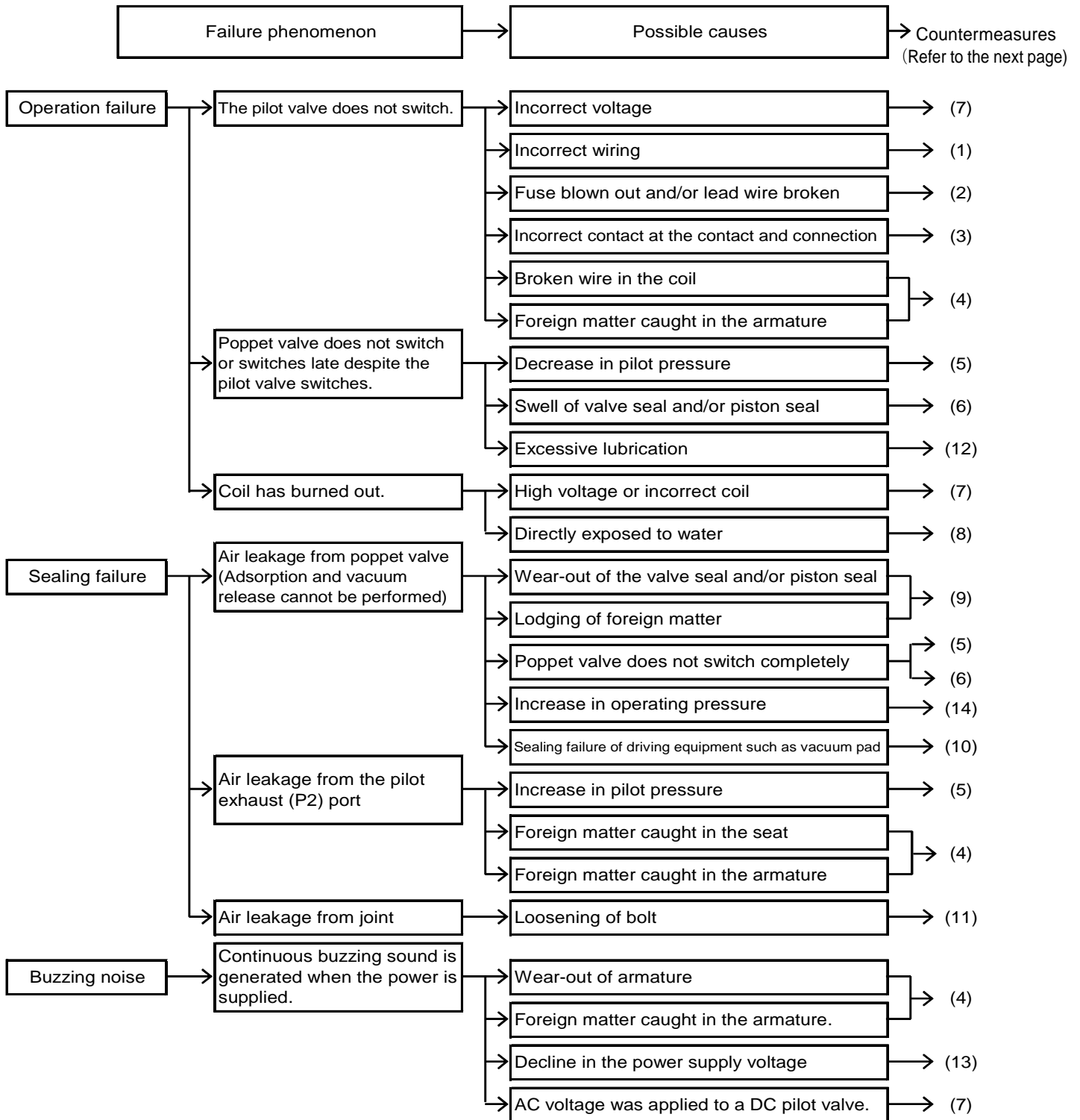

Countermeasures

No.	Countermeasures
(1)	Connect wires correctly.
(2)	Replace the parts.
(3)	Replace the parts or connect wires correctly.
(4)	Replace the valve.
(5)	Adjust the pressure so that pilot pressure is within the specified range during operation.
(6)	If incorrect oil has been used for lubrication, remove the oil with air blow and replace the valve with a new one. If a lubricant is used in the system after the replacing the valve, use turbine oil Class 1 (ISO VG32). If there is a large amount of condensate or condensate cannot be removed completely, mount an auto drain or install a dryer and replace the valve.
(7)	Check the voltage and replace the valve.
(8)	Protect the valve especially the coil to prevent it from being exposed to water.
(9)	If air leakage is caused by foreign matter, remove foreign matter in the piping by air blow and replace the valve.
(10)	Repair or replace the actuators.
(11)	Stop the air and additionally tighten the bolt. Check whether there is vibration or impact which has caused the loosening of the bolt. Install damping rubber so that the product is not affected by the vibration and impact.
(12)	Reduce the amount of lubrication to the amount at which the oil does not splash from the (pilot) exhaust port.
(13)	Adjust the voltage so that voltage during operation is within the specified range.
(14)	Adjust the voltage so that the upstream pressure (vacuum pressure) becomes the required (vacuum) pressure.

If the countermeasures above are not effective, there may be a problem with the valve.
Stop using the valve immediately.

If any of the examples below are applicable, there may be an internal problem with the valve.
Stop using the valve immediately.

1. Voltage was outside of the rated voltage.
2. Oils other than specified were supplied.
3. Lubrication was stopped in the middle of lubrication. Or, lubrication was interrupted temporarily.
4. Directly exposed to water
5. Severe impact was applied.
6. Foreign matter such as condensate or dust entered.
7. Other than the cases mentioned above, any usage which falls outside the precautions given in this Operation Manual.

*If the product has failed, then please return the valve as it is.

Revision history

1st printing : TW

SMC Corporation

4-14-1, Sotokanda, Chiyoda-ku, Tokyo 101-0021 JAPAN
Tel: + 81 3 5207 8249 Fax: +81 3 5298 5362
URL <http://www.smcworld.com>

Note: Specifications are subject to change without prior notice and any obligation on the part of the manufacturer.
© 2015 SMC Corporation All Rights Reserved