



# Operation Manual

PRODUCT NAME

Digital Pressure Switch  
( IO-Link compatible)

MODEL / Series / Product Number

*ZSE20C(F)-L*  
*ISE20C(H)-L*

**SMC Corporation**

## Table of Contents

Safety Instructions	2
Model Indication and How to Order	9
Summary of Product parts	11
Definition and terminology	13
Mounting and Installation	17
Installation	17
Piping	20
Wiring	22
Outline of Settings [Measurement mode]	24
Pressure Setting	25
3 Step Setting Mode	26
Simple Setting Mode	28
Function Selection Mode	30
Function selection mode	30
Default setting	30
F 0 Display units, switch output specifications and diagnostic information selection function	32
F 1 Setting of OUT1	34
F 2 Setting of OUT2	37
F 3 Digital filter setting	39
F 4 Auto-preset function	40
F 6 Fine adjustment of display value	42
F10 Sub display setting	43
F11 Display resolution setting	49
F14 Zero cut-off setting	50
F80 Power saving mode	51
F81 Security code	52
F90 Setting of all functions	54
F96 Number of pressurizing errors	56
F98 Output check	57
F99 Reset to default settings	59
Other Settings	60
IO-Link Specifications	64
Outline of IO-Link function	64
Communication specifications	64
Process data	65
IO-Link parameter setting	68
Maintenance	81
Forgotten the security code	81
Troubleshooting	82
Specification	92
Specifications	92
Dimensions	95



# Safety Instructions

These safety instructions are intended to prevent hazardous situations and/or equipment damage. These instructions indicate the level of potential hazard with the labels of "Caution", "Warning" or "Danger". They are all important notes for safety and must be followed in addition to International Standards (ISO/IEC)\*1), and other safety regulations.

\*1) ISO 4414: Pneumatic fluid power -- General rules relating to systems.  
ISO 4413: Hydraulic fluid power -- General rules relating to systems.  
IEC 60204-1: Safety of machinery -- Electrical equipment of machines .(Part 1: General requirements)  
ISO 10218: Manipulating industrial robots -Safety.  
etc.



## Caution

**Caution** indicates a hazard with a low level of risk which, if not avoided, could result in minor or moderate injury.



## Warning

**Warning** indicates a hazard with a medium level of risk which, if not avoided, could result in death or serious injury.



## Danger

**Danger** indicates a hazard with a high level of risk which, if not avoided, will result in death or serious injury.

## Warning

### 1. The compatibility of the product is the responsibility of the person who designs the equipment or decides its specifications.

Since the product specified here is used under various operating conditions, its compatibility with specific equipment must be decided by the person who designs the equipment or decides its specifications based on necessary analysis and test results.

The expected performance and safety assurance of the equipment will be the responsibility of the person who has determined its compatibility with the product.

This person should also continuously review all specifications of the product referring to its latest catalog information, with a view to giving due consideration to any possibility of equipment failure when configuring the equipment.

### 2. Only personnel with appropriate training should operate machinery and equipment.

The product specified here may become unsafe if handled incorrectly.

The assembly, operation and maintenance of machines or equipment including our products must be performed by an operator who is appropriately trained and experienced.

### 3. Do not service or attempt to remove product and machinery/equipment until safety is confirmed.

1. The inspection and maintenance of machinery/equipment should only be performed after measures to prevent falling or runaway of the driven objects have been confirmed.

2. When the product is to be removed, confirm that the safety measures as mentioned above are implemented and the power from any appropriate source is cut, and read and understand the specific product precautions of all relevant products carefully.

3. Before machinery/equipment is restarted, take measures to prevent unexpected operation and malfunction.

### 4. Contact SMC beforehand and take special consideration of safety measures if the product is to be used in any of the following conditions.

1. Conditions and environments outside of the given specifications, or use outdoors or in a place exposed to direct sunlight.

2. Installation on equipment in conjunction with atomic energy, railways, air navigation, space, shipping, vehicles, military, medical treatment, combustion and recreation, or equipment in contact with food and beverages, emergency stop circuits, clutch and brake circuits in press applications, safety equipment or other applications unsuitable for the standard specifications described in the product catalog.

3. An application which could have negative effects on people, property, or animals requiring special safety analysis.

4. Use in an interlock circuit, which requires the provision of double interlock for possible failure by using a mechanical protective function, and periodical checks to confirm proper operation.



# Safety Instructions

## Caution

### **1. The product is provided for use in manufacturing industries.**

The product herein described is basically provided for peaceful use in manufacturing industries. If considering using the product in other industries, consult SMC beforehand and exchange specifications or a contract if necessary.  
If anything is unclear, contact your nearest sales branch.

## **Limited warranty and Disclaimer/Compliance Requirements**

The product used is subject to the following "Limited warranty and Disclaimer" and "Compliance Requirements".

Read and accept them before using the product.

### **Limited warranty and Disclaimer**

#### **1. The warranty period of the product is 1 year in service or 1.5 years after the product is delivered, whichever is first.\*2)**

Also, the product may have specified durability, running distance or replacement parts. Please consult your nearest sales branch.

#### **2. For any failure or damage reported within the warranty period which is clearly our responsibility, a replacement product or necessary parts will be provided.**

This limited warranty applies only to our product independently, and not to any other damage incurred due to the failure of the product.

#### **3. Prior to using SMC products, please read and understand the warranty terms and disclaimers noted in the specified catalog for the particular products.**

\*2) Vacuum pads are excluded from this 1 year warranty.

A vacuum pad is a consumable part, so it is warranted for a year after it is delivered.

Also, even within the warranty period, the wear of a product due to the use of the vacuum pad or failure due to the deterioration of rubber material are not covered by the limited warranty.

### **Compliance Requirements**

#### **1. The use of SMC products with production equipment for the manufacture of weapons of mass destruction (WMD) or any other weapon is strictly prohibited.**

#### **2. The exports of SMC products or technology from one country to another are governed by the relevant security laws and regulation of the countries involved in the transaction. Prior to the shipment of a SMC product to another country, assure that all local rules governing that export are known and followed.**

## Caution

### **SMC products are not intended for use as instruments for legal metrology.**

Products that SMC manufactures or sells are not measurement instruments that are qualified by pattern approval tests relating to the measurement laws of each country.

Therefore, SMC products cannot be used for business or certification ordained by the measurement laws of each country.

## Operator

- ◆ This operation manual is intended for those who have knowledge of machinery using pneumatic equipment, and have sufficient knowledge of assembly, operation and maintenance of such equipment. Only those persons are allowed to perform assembly, operation and maintenance.
- ◆ Read and understand this operation manual carefully before assembling, operating or providing maintenance to the product.

### ■ Safety Instructions

#### **Warning**

- Do not disassemble, modify (including changing the printed circuit board) or repair.  
An injury or failure can result.
- Do not operate the product outside of the specifications.  
Do not use for flammable or harmful fluids.  
Fire, malfunction, or damage to the product can result.  
Verify the specifications before use.
- Do not operate in an atmosphere containing flammable or explosive gases.  
Fire or an explosion can result.  
This product is not designed to be explosion proof.
- Do not use the product in a place where static electricity is a problem.  
Otherwise it can cause failure or malfunction of the system.
- If using the product in an interlocking circuit:
  - Provide a double interlocking system, for example a mechanical system
  - Check the product regularly for proper operationOtherwise malfunction can result, causing an accident.
- The following instructions must be followed during maintenance:
  - Turn off the power supply
  - Stop the air supply, exhaust the residual pressure and verify that the air is released before performing maintenanceOtherwise an injury can result.

## ⚠ Caution

- Do not touch the terminals and connectors while the power is on.  
Otherwise electric shock, malfunction or damage to the product can result.
- After maintenance is complete, perform appropriate functional inspections and leak tests.  
Stop operation if the equipment does not function properly or there is a leakage of fluid.  
When leakage occurs from parts other than the piping, the product might be faulty.  
Disconnect the power supply and stop the fluid supply.  
Do not apply fluid under leaking conditions.  
Safety cannot be assured in the case of unexpected malfunction.

### ■ NOTE

○ Follow the instructions given below when designing, selecting and handling the product.

- The instructions on design and selection (installation, wiring, environment, adjustment, operation, maintenance, etc.) described below must also be followed.

\*Product specifications

- Use the specified voltage.  
Otherwise failure or malfunction can result.
- Do not exceed the specified maximum allowable load.  
Otherwise it can cause damage or shorten the lifetime of the Pressure switch.
- Design the product to prevent reverse current when the circuit is opened or the product is forced to operate for operational check.  
Reverse current can cause malfunction or damage to the product.
- Input data to the Pressure switch is not deleted, even if the power supply is cut off.  
(Writing time: 10,000 times, Data duration: 20 years after power off)

● A pressure sensor of stainless steel diaphragm is used for this switch. The pressure sensor of this switch can be damaged by the rush inertia of water when the drain contained in water and air collide with the pressure sensor when vacuum is broken after vacuum adsorption is confirmed, and it may cause malfunction with the pressure indication. If there is a possibility of water or drainage getting in, narrow the diameter of the piping to the pressure switch, or make an orifice in the middle of the piping shown in the Fig. right. Extra attention is needed when the rear piping type model is used.

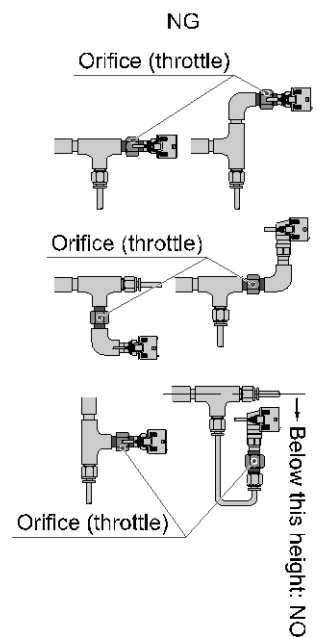
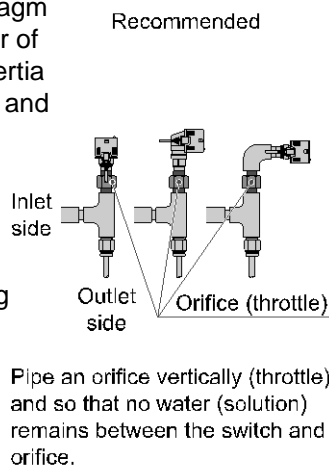

- Some fluids may generate static electricity when resin piping is used for piping. Take measures against static electricity with equipment when this switch is used in connection with resin piping. Also, the ground should be separate from that of the units that generate strong electromagnetic noise or high frequency, otherwise, the switch can be damaged by static electricity.
- Applicable fluid is a fluid that does not corrode SUS630 and SUS304.  
Do not use a fluid containing chemicals, synthetic oils including organic solvent, salt and corrosive gases. Otherwise, damage to the product and malfunction can result.  
Check the details of the specifications before using.
- Use the specified measurement flow rate and operating pressure.  
Otherwise it can cause damage to the pressure switch or inability to measure correctly.
- Reserve a space for maintenance.  
Allow sufficient space for maintenance when designing the system.

## ●Product handling

### \*Installation

- Tighten to the specified tightening torque.  
If the tightening torque is exceeded the mounting screws and brackets may be broken.  
If the tightening torque is insufficient, the product can be displaced and loosen the mounting screws.
- Do not apply excessive stress to the product when it is mounted with a panel mount.  
Otherwise damage to the product and disconnection from the panel mount can result.
- Be sure to ground terminal FG when using a commercially available switch-mode power supply.
- Do not drop, hit or apply shock to the Pressure switch.  
Otherwise damage to the internal parts can result, causing malfunction.
- Do not pull the lead wire forcefully, not lift the product by pulling the lead wire. (Tensile force 35 N or less)  
Hold the body when handling to avoid the damage of the Pressure switch which lead to cause the failure and malfunction.
- For piping of the Pressure switch, hold the piping with a spanner on the metal part of the piping (Piping attachment).  
Holding other part with spanner leads to damage the Pressure switch.
- Eliminate any dust left in the piping by air blow before connecting the piping to the product.  
Otherwise it can cause damage or malfunction.
- Do not insert metal wires or other foreign matter into the pressure measurement port.  
It can damage the pressure sensor causing failure or malfunction.
- Never mount a Pressure switch in a location that will be used as a foothold.  
The product may be damaged if excessive force is applied by stepping or climbing onto it.
- If the entering of foreign material to the fluid is possible, install and pipe the filter or the mist separator to the inlet to avoid failure and malfunction.
- Helium leakage test is conducted on the welding parts. Use a ferrule by Swagelok Company (Swagelok® fittings) as the TSJ fittings and packing, ground, etc. by Swagelok Company (VCR® fittings) as the URJ fittings. If a ferrule, packing or ground by other manufacturers are to be used, conduct helium leakage test before using those products.  
\*: Swagelok® and VCR® are trademarks of Swagelok Company.

### \*Wiring

- Do not pull the lead wires.  
In particular, never lift a Pressure switch equipped with fitting and piping by holding the lead wires.  
Otherwise damage to the internal parts can result, causing malfunction or to be off the connector.
- Avoid repeatedly bending or stretching the lead wire, or placing heavy load on them.  
Repetitive bending stress or tensile stress can cause the sheath of the wire to peel off, or breakage of the wire.  
If the lead wire can move, fix it near the body of the product.  
The recommended bend radius of the lead wire is 6 times the outside diameter of the sheath, or 33 times the outside diameter of the insulation material, whichever is larger.  
Replace the damaged lead wire with a new one.
- Wire correctly.  
Incorrect wiring can break the Pressure switch.

- Do not perform wiring while the power is on.  
Otherwise damage to the internal parts can result, causing malfunction.
- Do not route wires and cables together with power or high voltage cables.  
Otherwise the product can malfunction due to interference of noise and surge voltage from power and high voltage cables to the signal line. Route the wires (piping) of the product separately from power or high voltage cables.
- Confirm proper insulation of wiring.  
Poor insulation (interference from another circuit, poor insulation between terminals, etc.) can lead to excess voltage or current being applied to the product, causing damage.
- Design the system to prevent reverse current when the product is forced to operate for operational check.  
Depending on the circuit used, insulation may not be maintained when operation is forced, allowing reverse current to flow, which can cause malfunction and damage the product.
- Keep wiring as short as possible to prevent interference from electromagnetic noise and surge voltage.  
Do not use a cable longer than 20 m.  
Wire the DC(-) line(blue) as close as possible to the power supply.

\*Environment

- Do not use the product in area that is exposed to corrosive gases, chemicals, sea water, water or steam.  
Otherwise failure or malfunction can result.
- Do not use in a place where the product could be splashed by oil or chemicals.  
If the product is to be used in an environment containing oils or chemicals such as coolant or cleaning solvent, even for a short time, it may be adversely affected (damage, malfunction, or hardening of the lead wires).
- Do not use in an area where surges are generated.  
If there is equipment which generates a large amount of surge (solenoid type lifter, high frequency induction furnace, motor, etc.) close to the Pressure switch, this may cause deterioration or breakage of the internal circuit of the Pressure switch. Avoid sources of surge generation and crossed lines.
- Do not use a load which generates surge voltage.  
When a surge-generating load such as a relay or solenoid is driven directly, use a load with a built-in surge suppressor.
- The product is CE/UKCA marked, but not immune to lightning strikes. Take measures against lightning strikes in the system.
- Mount the product in a place that is not exposed to vibration or impact.  
Otherwise failure or malfunction can result.
- Prevent foreign matter such as remnant of wires from entering the Pressure switch.  
Take proper measures for the remnant not to enter the Pressure switch in order to prevent failure or malfunction.
- Do not use the product in an environment that is exposed to temperature cycle.  
Heat cycles other than ordinary changes in temperature can adversely affect the inside of the product.
- Do not expose the product to direct sunlight.  
If using in a location directly exposed to sunlight, shade the product from the sunlight.  
Otherwise failure or malfunction can result.
- Keep within the specified fluid and ambient temperatures range.  
The fluid and ambient temperatures should be -5 to 50 °C. Operation under low temperature (5 °C or less) leads to cause damage or operation failure due to frozen moist in the fluid or air.  
Protection against freezing is necessary. Air dryer is recommended for elimination of drain and water.  
Avoid sudden temperature change even within specified temperature.
- Do not operate close to a heat source, or in a location exposed to radiant heat.  
Otherwise malfunction can result.
- Use operating fluid which does not corrode the part in contact with fluid which is made of SUS630 (for sensing part) or SUS304 (for fitting part).  
(Compatibility between fluid and material can be checked by contact to fluid supplier.)
- When resin piping is used, depending on the fluid, static electricity may occur. When connecting the switch and sensor, please take adequate anti-static electricity measures on the equipment side, and do not use with a grounding that is shared with equipment that generates strong electromagnetic noise or high-frequency waves.  
This can result in a switch or sensor being damaged by static electricity.



#### \*Adjustment and Operation

- Turn the power on after connecting a load.  
Otherwise it can cause excess current causing instantaneous breakage of the Pressure switch.
- Do not short-circuit the load.  
Although error is displayed when the Pressure switch load is short circuit, generated excess current lead to cause the damage of the Pressure switch.
- Do not press the setting buttons with a sharp pointed object.  
It may damage the setting buttons.
- If using the product to detect very small pressure rates, warm up the product for 10 to 15 minutes first.  
There will be a drift on the display of approximate  $\pm 2$  to 3% immediately after the power supply is turned on, within 10 minutes.
- Perform settings suitable for the operating conditions.  
Incorrect setting can cause operation failure.  
For details of each setting, refer to page 24 to 63 of this manual.
- Do not touch the LCD during operation.  
The display can vary due to static electricity.

#### \*Maintenance

- Turn off the power supply, stop the supplied air, exhaust the residual pressure and verify the release of air before performing maintenance.  
There is a risk of unexpected malfunction.
- Perform regular maintenance and inspections.  
There is a risk of unexpected malfunction.
- Perform drainage regularly.  
If condensate enters the secondary side, it can cause operating failure of pneumatic equipment.
- Do not use solvents such as benzene, thinner etc. to clean the Pressure switch.  
They could damage the surface of the body and erase the markings on the body.  
Use a soft cloth to remove stains. For heavy stains, use a cloth soaked with diluted neutral detergent and fully squeezed, then wipe up the stains again with a dry cloth.

# Model Indication and How to Order

**ISE20C** - L - **M** - **02** □ - □ □ □

Pressure range

	Symbol	Content
Positive pressure	ISE20C	-0.100 to 1.000 MPa
Vacuum pressure	ZSE20C	0.0 to -101.0 kPa
Compound pressure	ZSE20CF	-100.0 to 100.0 kPa
Positive pressure	ISE20CH	-0.100 to 2.000 MPa

Output specification

Symbol	Content
L	IO-Link/Switch 1 output (Switch output can be selected, NPN or PNP)

Unit specification

Symbol	Content
Nil	With units selection function *1
M	Fixed SI unit *2
P	With units selection function (psi initial value) *1

\*1: The new Measurement Law prohibits the use of pressure switch with the units selection function in Japan. A unit label is attached.

\*2: Fixed unit kPa, MPa

Piping specification

Symbol	Content	Symbol	Content
02	R1/4	C01	Rc1/8
N02	NPT1/4	A2	URJ1/4 (Face seal fitting)
F02	G1/4	B2	TSJ1/4 (Compression fitting)

Option 3

Symbol	Content
Nil	With operation manual
Y	None
K	With operation manual + calibration certificate
T	With calibration certificate

Option 2 \*3

Symbol	Content
Nil	No option
A1	Bracket A (rear piping)
A3	Bracket C (bottom piping)
B	Panel mount adapter (rear piping)
E	Panel mount adapter (bottom piping)
D	Panel mount adapter + Front protective cover (rear piping)
F	Panel mount adapter + Front protective cover (bottom piping)

\*3: Selection differs depending on the piping direction. Refer to Option 2 correspondence table below.

Option 1

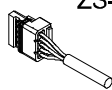
Symbol	Content
Nil	Without lead wire
W	Lead wire with connector (lead wire length 2 m, waterproof)  ZS-46-5F

Piping direction

Symbol	Content
Nil	Rear piping
L	Bottom piping

○ Option 2 correspondence table

Option2			Piping direction	
Items	Symbol	Part No.	Nil (Rear piping)	L (Bottom piping)
Bracket A	A1	ZS-46-A1	○	×
Bracket C	A3	ZS-46-E	×	○
Panel mount adapter	B	ZS-46-B	○	×
	E	ZS-35-B	×	○
Panel mount adapter + Front protective cover	D	ZS-46-D	○	×
	F	ZS-35-E	×	○

○Accessories/Part numbers

If an option is required independently, order with the following part numbers.

Items	Part No.	Remarks
Bracket A	ZS-46-A1	Rear piping Self tapping screws: Nominal size 3 x 8L (2 pcs.)
Bracket C	ZS-46-E	Bottom piping Self tapping screws: Nominal size 3 x 10L (2 pcs.)
Panel mount adapter	ZS-46-B	Rear piping
	ZS-35-B	Bottom piping
Panel mount adapter + Front protective cover	ZS-46-D	Rear piping
	ZS-35-E	Bottom piping
Lead wire with connector	ZS-46-5F	5 cores, 2 m, waterproof
Front protective cover	ZS-27-01	Rear piping
	ZS-35-01	Bottom piping

## Summary of Product parts

### Names of individual parts

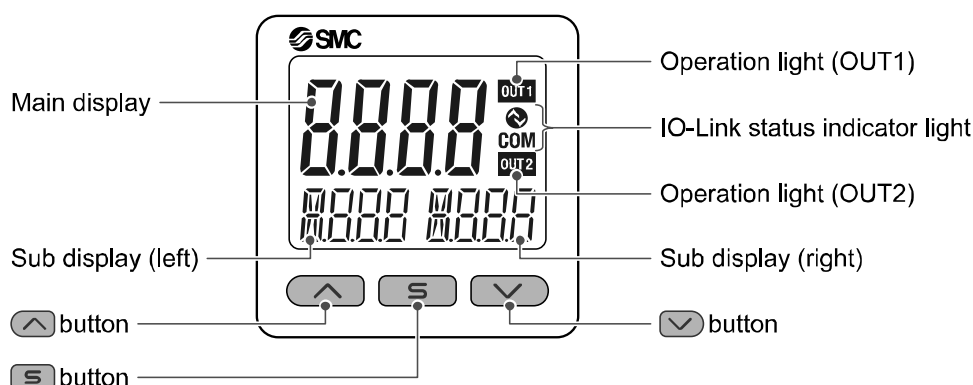

Operation light: Displays the switch operating condition.

Main display: Displays pressure measurement values and error codes. (2-color display)

Sub display (left): Displays items. (Orange)

Sub display (right): Displays set values, peak and bottom values. (Orange)



▲ button: Increases mode and ON/OFF set values.

▼ button: Decreases mode and ON/OFF set values.

⏏ button: Press this button to change mode and to confirm settings.

IO-Link status indicator light: Displays OUT1 output communication status (SIO mode, start-up mode, Pre-operation mode, operation mode) and presence of communication data.

•IO-Link indicator light operation and display

Communication with master	IO-Link indicator light		Status		Sub screen display *1	Content	
	COM						
Yes			IO-Link mode	Correct	Operate	ModE oPE	Normal communication status (Reading of measurement value)
				Abnormal	Start up	ModE StErE	When communication starts up.
					Preoperate	ModE PrE	
	No	○	○	SIO mode	Version does not match	Er 15 V 1.0	Version of master and IO-Link does not match *2
Lock					ModE LoE	Back-up and re-store required due to data storage lock	
No	○	○	SIO mode	Communication shut-off	ModE StErE ModE PrE ModE oPE	Correct communication was not received for 1 second or more.	
				General switch output	ModE S iO	General switch output	

LCD display: "○" OFF, "◐" Flashing, "◑" ON

\*1: "ModE - -" is displayed when selecting the modes on the sub screen.

\*2: When the product is connected to the master with version "V1.0", error Er15 is generated.

## ■ Definition and terminology

	Term	Definition
A	Auto-preset	Performs pressure setting automatically by detecting the increase and decrease in pressure. For example, if this function is used for a suction test, the pressure setting will be completed by performing suction and release of the workpiece.
B	Bottom value display (mode)	Shows the minimum pressure from when the power was supplied to the current time.
C	Chattering	The problem of the switch output turning ON and OFF repeatedly around the set value at high frequency due to the effect of pulsation.
	Chattering prevention function	A function to delay the response time of switch output in order to prevent chattering.
D	Delay time	The setting time from when the pressure applied to the pressure switch reaches the set value, to when the ON-OFF output actually begins working. Delay time setting can prevent the output from chattering.
	digit (Min. setting unit)	Shows how precisely the pressure can be displayed or set by the digital pressure switch. When 1 digit = 1 kPa, the pressure is displayed in increments of 1 kPa, e.g., 1, 2, 3, ..., 99, 100.
	Digital filter	Function to add digital filtering to the fluctuation of pressure value. Smooth the fluctuation of displayed value for sharp start up or fall of the pressure. When the function is valid, digital filtering is reflected to the ON/OFF of the switch output. Output chattering or flicker in the measurement mode display can be reduced by setting the digital filter. The response time indicates when the set value is 90% in relation to the step input.
	Display accuracy	Shows The maximum deviation between the displayed pressure value and the true pressure.
	Display color	Indicates the color of the number of digital display. Always green, always red, green (switch OFF) → red (switch ON), red (switch OFF) → green (switch ON) are available.
	Display resolving power	Indicate in how many the rated pressure range can be divided to display. (Example: When the value can be displayed down to 0.001 MPa for the product for 0 to 1 Mpa, the resolution is 1/1000)
	Display value fine adjustment (function)	Displayed pressure value can be adjusted within the range of $\pm 5\%$ R.D. ( $\pm 5\%$ of displayed value). It is used if the true pressure value is known, or to eliminate differences between the displayed values of different instruments that are measuring the same pressure.
E	Error displayed	The code number displayed, identifying the error detected by the self-diagnostic function of the pressure switch. Refer to "Error indication function" on page 91 for details of the errors.
	Error output	Switches the switch output to ON/OFF when an error is displayed. Refer to "List of output modes" on page 36 for operating conditions. Refer to "Error indication function" on page 91 for details of the errors.

	Term	Definition
F	F.S. (full span/full scale)	Abbreviation of full span and full scale; difference between the minimum and maximum rated pressure values. means the maximum fluctuation range of the pressure switch rated value. For example, when the rated pressure range is 0.000 to 1.000 [MPa]: F.S. = 1.000 - (0.000) = 1.000 [MPa] (Reference: 1%F.S. = 1.000 x 0.01 = 0.010 [MPa])
	Fine adjustment mode	Refer to "Display value fine adjustment (function)".
	Fluid contact part (or wetted part)	Part of the pressure switch which contacts detected fluid. Pressure sensor, seal and fitting are included.
	Function selection mode	A mode in which setting of functions is performed. It is a separate menu from the pressure setting. If any function settings need to be changed from the factory default, each setting can be selected with "F*". The setting items are: operation mode, output type, display color, digital filter, use of auto preset, display value fine adjustment, sub screen display, display resolution, use of power saving mode and use of security code.
H	Hysteresis	Difference between the points at which the pressure switch is turned ON and OFF.
	Hysteresis mode	Refer to the "List of output modes" on page 36.
I	Insulation resistance	Insulation resistance of the product. The resistance between the electrical circuit and the case.
K	Key-lock function	Function that prevents changes to the settings of the Pressure switch (disables button operation).
M	Manual setting	Manual pressure setup without using auto preset. This term is used to distinguish between manual and auto preset pressure setup.
	Maximum applied voltage	The maximum voltage that can be connected to the output of an NPN device.
	Maximum load current	The maximum current that can flow to the output (output line) of the switch output.
	Measurement mode	Operating condition in which pressure is being detected and displayed, and the switch function is working.
	Min. setting unit	Refer to "digit".
N	Normal output	One of the switch output types. In hysteresis mode the switch output is turned ON when pressure equal to or greater than the switch output set value is detected. In window comparator mode, the switch output is turned ON when pressure between the switch output set values (P1L to P1H) is detected. (Refer to the "List of output modes" on page 36.)
O	Operation light	A light that turns on when the switch output is ON.
	Operation mode	Hysteresis mode, window comparator mode, Error output or Output off can be selected.
	Output style	The operation principle of the switch output. Normal output and reverse output can be selected. Please refer to the "List of output modes" on page 36 operating conditions.

	Term	Definition
P	Peak value display (mode)	Shows the maximum pressure from when the power was supplied to the current time.
	Port size	The diameter of the connecting part of the switch for connecting with the object to be measured.
	Power saving mode	Operating mode in which the digital display turns off and power consumption is reduced.
	Pressure setting	The set pressure value that determines the point at which the pressure switch turns ON and OFF.
	Proof pressure	Pressure limit that if exceeded will result in mechanical and/or electrical damage to the product.
R	R.D.	Current read value For example, when the display value is 1.000[MPa], $\pm 5\%$ R.D. is $\pm 5\%$ of 1.000[MPa], which becomes $\pm 0.05$ [MPa]. When the display value is 0.800[MPa], $\pm 5\%$ R.D. is $\pm 5\%$ of 0.800[MPa], which becomes $\pm 0.04$ [MPa].
	Rated pressure range	The pressure range within which the product will meet all published specifications. Values outside of this range can be set as long as they are within the set pressure range, but the specifications cannot be guaranteed.
	Repeatability	Variation in repeated measurement of pressure display or ON-OFF output point when the pressure changes at 25 centigrade.
	Residual voltage	The difference between the ideal ON voltage and the actual voltage when the switch output is on. Varies with load current. Ideally should be 0 V.
	Resolution	Refer to "Display resolution".
	Reversed output	One of the switch output types. In hysteresis mode the switch output is turned ON when pressure less than or equal to the switch output set value is detected. In window comparator mode, the switch output is turned ON when pressure is outside the switch output set values (n1L to n1H) is detected. (Refer to the "List of output modes" on page 36.)
	Ripple	A type of chattering.
S	Set pressure range	The pressure range that can be set for switch output.
	Switch output	Sometimes referred to as "ON-OFF output".
U	Units selection function	A function to change the units in which the measured pressure value is displayed. The display units can only be changed if the product is equipped this function. It is not possible to purchase the product with this function if the product is used in Japan. The product for Japan is displayed in SI only.



	Term	Definition
W	Window comparator mode	An operating mode in which the switch output is turned on and off depending on whether the flow is inside or outside the range of two set values. (Refer to the "List of output modes" on page 36.)
	Withstand voltage	A measure of the product's resistance to a voltage applied between the electrical circuit and case. Durability in withstanding voltage. The product may be damaged if a voltage over this value is applied. (The withstand voltage is not the supply voltage used to power the product.)
Z	Zero-clear function	This function to adjust the displayed pressure to zero.

# Mounting and Installation

## ■ Installation

### ○ Mounting

- Mount the optional bracket and panel mount adapter to the pressure switch.
- When the pressure switch is to be mounted in a place where water and dust splashes occur, insert a tube into the atmospheric vent port of the pressure switch.  
(Refer to “Tube attachment” on page 21.)

### ○ Mounting with bracket

- Mount the bracket to the body with mounting screws (Self tapping screws: Nominal size 3 x 8L (2 pcs.)), then set the body to the specified position.

\*: Tighten the bracket mounting screws to a torque of  $0.5 \pm 0.05$  N·m.

Self tapping screws are used, and should not be re-used several times.

#### <Rear piping>

- Bracket A (Part No.: ZS-46-A1)

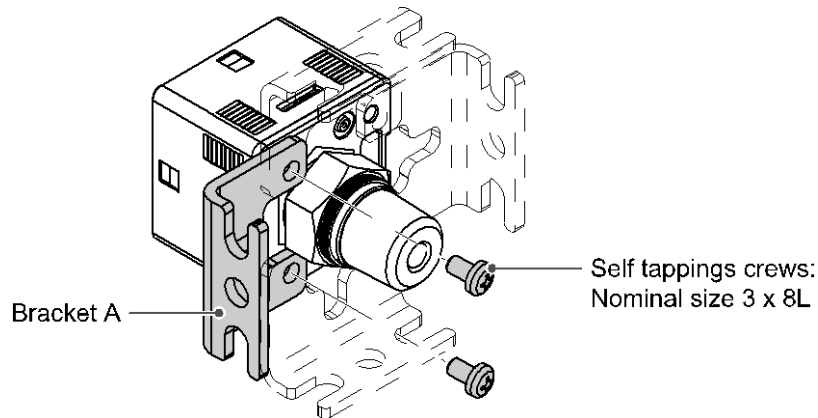

#### <Bottom piping>

- Bracket C (Part No.: ZS-46-E)

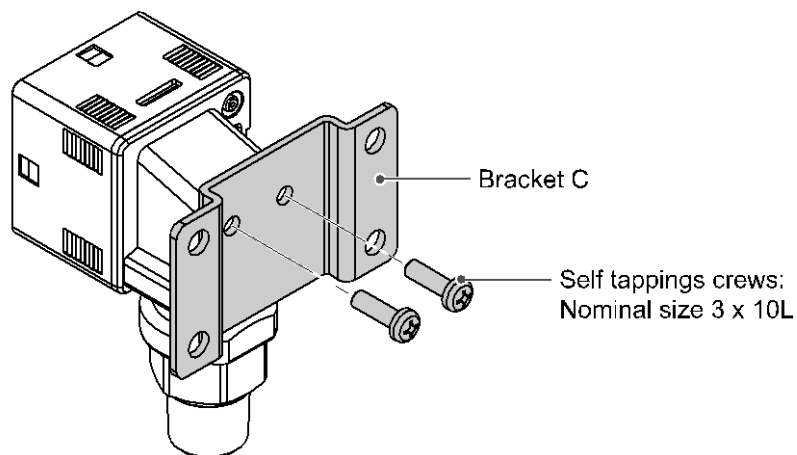

○ Mounting with panel mount adapter

<Rear piping>

- Mount part (a) to the front of the body and fix it. Then insert the body with (a) into the panel until (a) comes into contact with the panel front surface. Next, mount part (b) to the body from the rear and insert it until (b) comes into contact with the panel for fixing.

- Panel mount adapter (Part No.: ZS-46-B)

Panel mount adapter + Front protective cover (Part No.: ZS-46-D)

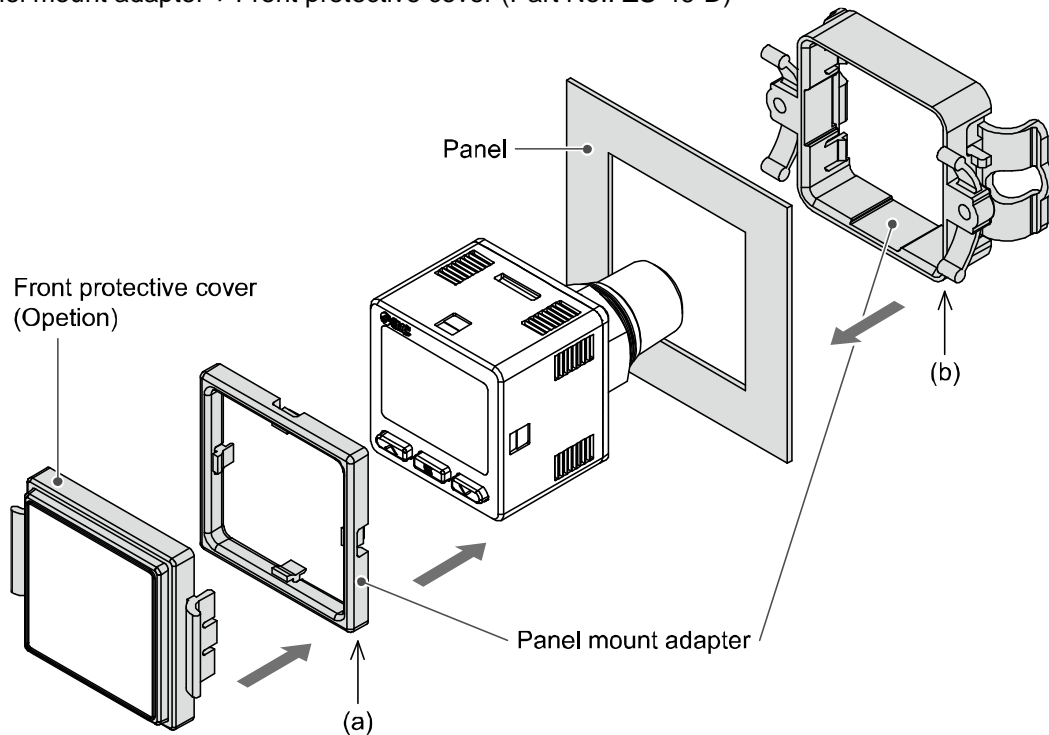

\*: The panel mount adapter can be rotated through 90 degrees for mounting.

**How to remove the panel mount adapter**

- When removing the digital pressure switch with panel mount adapter from the installation, pull it forward while expanding the hooks on each side as shown below. If the panel mount adapter is pulled forward with the hook caught, the product and the adapter may be damaged.

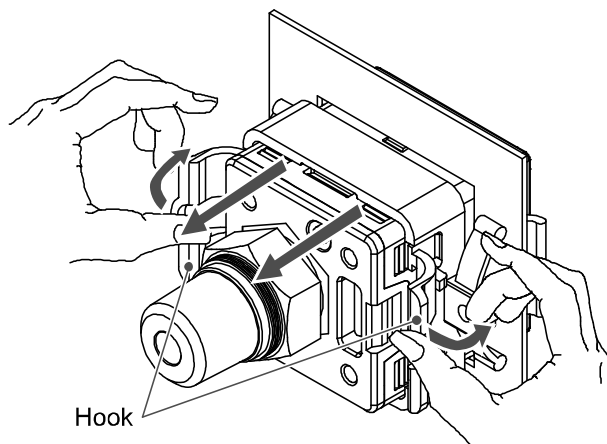

<Bottom piping>

- Holding a panel between panel mount adapter A and B.  
Then insert pressure switch and mounting bracket into the panel in that order.

- Panel mount adapter (Part No.: ZS-35-B)

- Panel mount adapter + Front protective cover (Part No.: ZS-35-E)

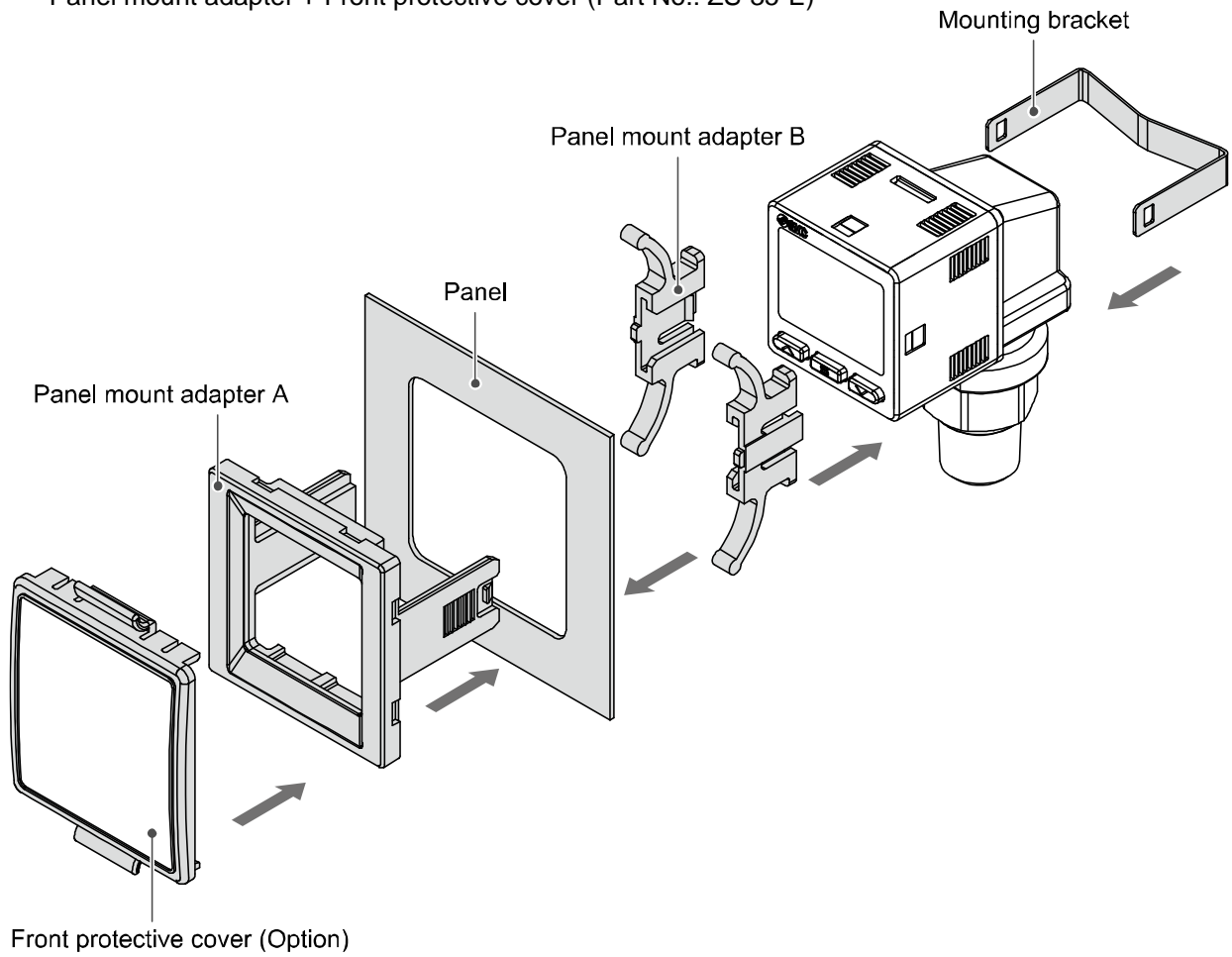

## ■Piping

### ○Connection using screw type fitting

- Connect suitable piping to the port.
- To connect the hexagon socket head plug or fitting to the pressure port, hold the hexagon part of the pressure port with a suitable spanner. Apply a tightening torque of 8 to 12 N•m.

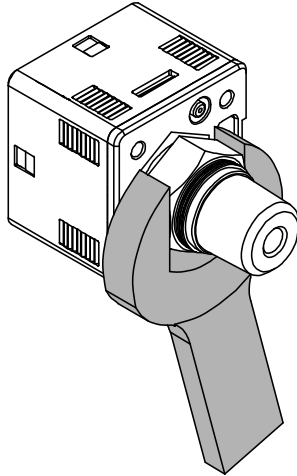

When tightening, do not hold the pressure switch body with a spanner.

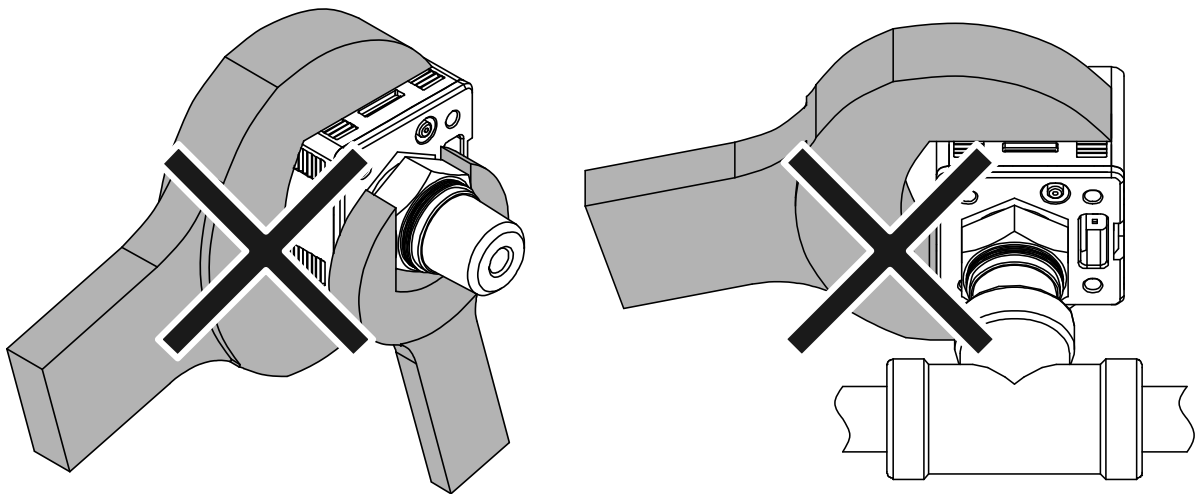

### ○Tube attachment

- When the pressure switch is used in a place where water and dust splashes may occur, insert a tube in the atmospheric vent port, and position the other end of the tube at safe position to protect the vent port from water and dust (see the figure bottom).

\*: The tube should be inserted to the end of the atmospheric vent port.

\*: SMC TU0425 (polyurethane, O.D  $\phi$ 4, I.D  $\phi$ 2.5) is a suitable tubing.

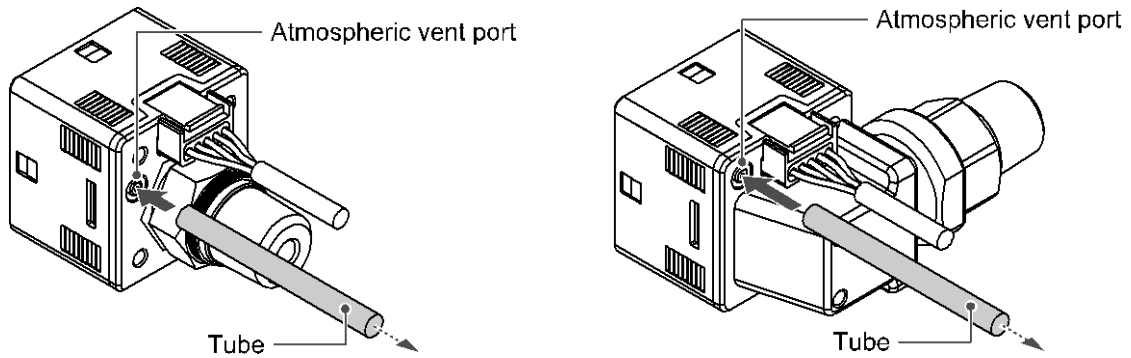

To a safe position to protect from water and dust.

## ■Wiring

### ○Wiring connections

- Connections should be made with the power supply turned off.
- Use a separate route for the product wiring and any power or high voltage wiring. Otherwise, malfunction may result due to noise.
- If a commercially available switching power supply is used, be sure to ground the frame ground (FG) terminal. If the switching power supply is connected for use, switching noise will be superimposed and it will not be able to meet the product specifications. In that case, insert a noise filter such as a line noise filter/ferrite between the switching power supplies or change the switching power supply to the series power supply.

### ○How to use connector

#### Connector attachment/detachment

- When connecting the connector, insert it straight onto the pins, holding the lever and connector body, and lock the connector by pushing the lever hook into the concave groove on the housing.
- To detach the connector, remove the hook from the groove by pressing the lever downward, and pull the connector straight out.

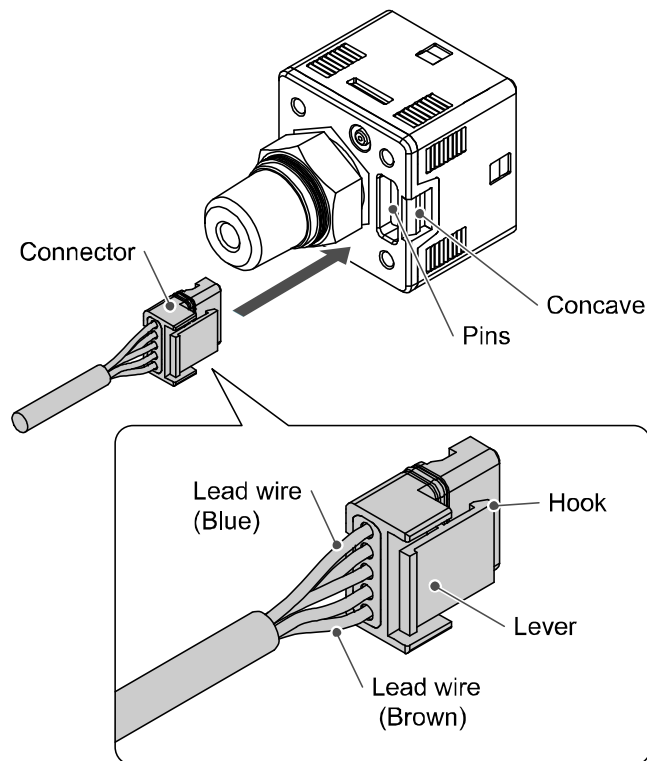

#### Connector pin numbers

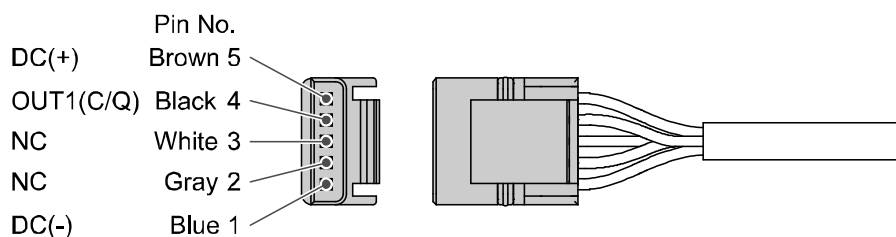

○ Internal circuit and wiring examples

- Used as switch output device

Setting of PNP open collector 1 output

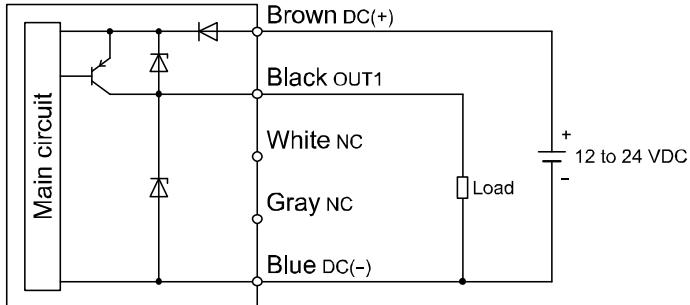

Setting of NPN open collector 1 output

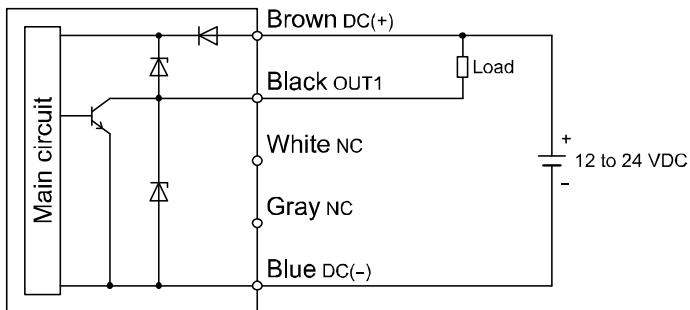

- Used as IO-Link device

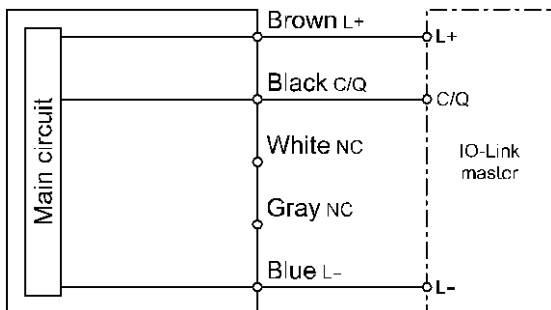



# Outline of Settings [Measurement mode]

Power is supplied.



The product code is displayed for approximately 3 sec. after supplying power.

\*: Within approximately 0.2 second after power-on, the switch starts.



## [Measurement mode]

Detects the pressure after power is supplied, and indicates the display and switch operating status. This is the basic mode; other modes should be selected for set-point changes and other function settings.

### Measurement mode screen

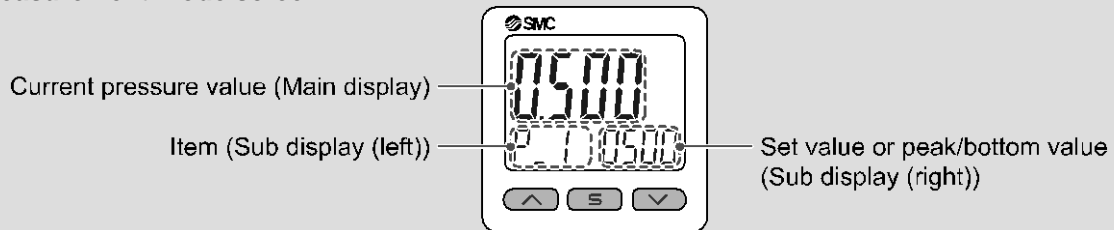

### Sub display

In measurement mode, the display of the sub display can be temporarily changed by pressing the or buttons.

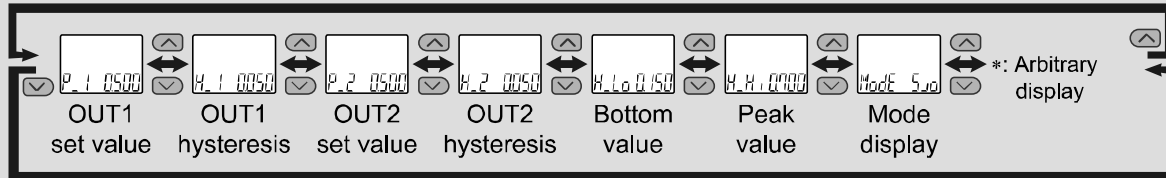

\*: One arbitrary display mode can be added to the sub display by setting the [F10] sub display setting.

If the sub display is switched during the arbitrary display setting, the display will be returned to the arbitrary display 30 seconds later. (The default setting does not include arbitrary display.)

Press the button once.

Press the button between 1 and 3 sec.

Press the button between 3 and 5 sec.



**Set either of set value or hysteresis.**  
(3 step setting mode)  
(Refer to page 26.)

**Select the set value, hysteresis and delay time.**  
(Simple setting mode)  
(Refer to page 28.)

**Change the function settings.**  
(Function selection mode)  
(Refer to page 30.)

**Other Settings**  
•Zero-clear function  
•Key-lock function  
(Refer to page 60.)

\*: The outputs will continue to operate during setting.

\*: If a button operation is not performed for 3 seconds during the setting, the display will flash.

(This is to prevent the setting from remaining incomplete if, for instance, an operator were to leave during setting.)

\*: 3 step setting mode, simple setting mode and function selection mode settings are reflected each other.

# Pressure Setting

## Default settings

When the pressure exceeds the set value, the switch will be turned on. When the pressure falls below the set value by the amount of hysteresis or more, the switch will be turned off. The default setting is to turn on the pressure switch when the pressure reaches the center of the atmospheric pressure and upper limit of the rated pressure range. If this condition, shown to the below, is acceptable, then keep these settings.

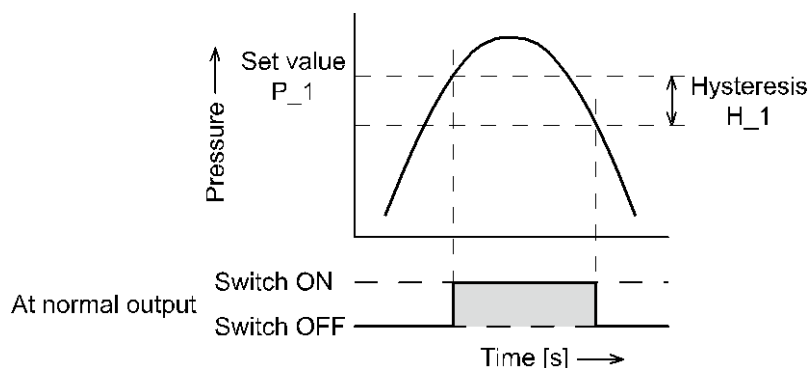

### ●ISE20C

Item	Default setting
[P_1] Set value of OUT1	0.500 MPa
[H_1] Hysteresis of OUT1	0.050 MPa

Item	Default setting
[P_2] Set value of OUT2	0.500 MPa
[H_2] Hysteresis of OUT2	0.050 MPa

### ●ZSE20C

Item	Default setting
[P_1] Set value of OUT1	-50.5 kPa
[H_1] Hysteresis of OUT1	5.1 kPa

Item	Default setting
[P_2] Set value of OUT2	-50.5 kPa
[H_2] Hysteresis of OUT2	5.1 kPa

### ●ZSE20CF

Item	Default setting
[P_1] Set value of OUT1	50.0 kPa
[H_1] Hysteresis of OUT1	5.0 kPa



Item	Default setting
[P_2] Set value of OUT2	50.0 kPa
[H_2] Hysteresis of OUT2	5.0 kPa

### ●ISE20CH

Item	Default setting
[P_1] Set value of OUT1	1.000 MPa
[H_1] Hysteresis of OUT1	0.100 MPa

Item	Default setting
[P_2] Set value of OUT2	1.000 MPa
[H_2] Hysteresis of OUT2	0.100 MPa

### Zero-clear of display

The display is reset to zero when the  and  buttons are pressed simultaneously for 1 second. For the first operation, perform a zero-clear without pressure at measurement mode.

## 3 Step Setting Mode

### 3 step setting mode



In this mode, the set values can be input in just 3 steps.

Use this mode if the product is to be used straight away, after changing only the set values.

(The current pressure value is displayed on the main display.)





#### <Operation>

[3 step setting mode (hysteresis mode)]

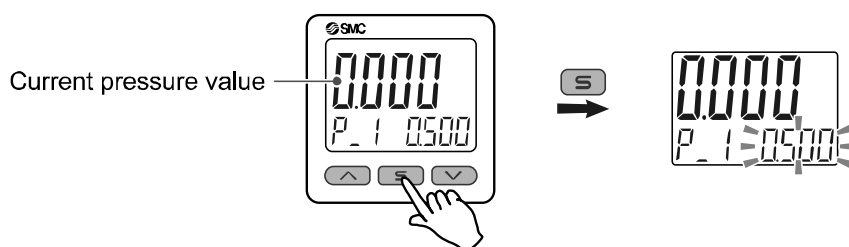
In the 3 step setting mode, the set value (P\_1 or n\_1, P\_2 or n\_2) and hysteresis (H\_1 or H\_2) can be changed. Set the items on the sub display (set value or hysteresis) with  or  button. When changing the set value, follow the operation below. The hysteresis setting can be changed in the same way.

- (1) Press the  button once when the item to be changed is displayed on the sub display. The set value on the sub display (right) will start flashing.





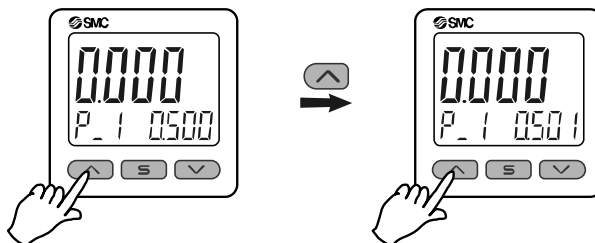

- (2) Press the  or  button to change the set value. The set value can be increased with  button and can be reduced with  button.

- Press the  button once to increase the value by one digit, press and hold to continuously increase.

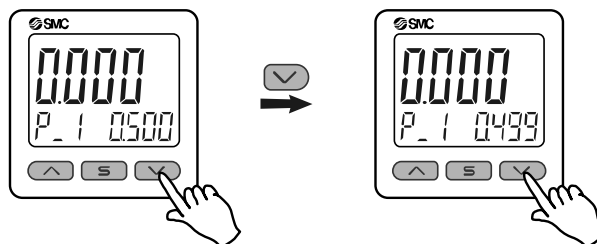

- Press the  button once to reduce the value by one digit, press and hold to continuously reduce.



- When the  and  buttons are pressed and held simultaneously for 1 second or longer, the set value is displayed as [- - -], and the set value will be the same as the current pressure value automatically (snap shot function (Refer to page 60.)). Afterwards, it is possible to adjust the value by pressing the  or  button.

- (3) Press the  button to complete the setting.

The Pressure switch turns on within a set pressure range (from P1L to P1H) during window comparator mode. Set P1L, the lower limit of the switch operation, and P1H, the upper limit of the switch operation and WH1 (hysteresis) following the instructions given on page 26.

(When reversed output is selected, the sub display (left) shows [n1L] and [n1H].)

Please refer to the "List of output modes" on page 36 for the relationship between the set values and operation.

\*: Set OUT2 in the same way. (OUT2 output available in the IO-Link communication process data)

Setting of the normal/reverse output switching and hysteresis/window comparator mode switching are performed with the function selection mode [F 1] Setting of OUT1 or [F 2] Setting of OUT2.

## Simple Setting Mode



### <Operation>

[Simple setting mode (hysteresis mode)]

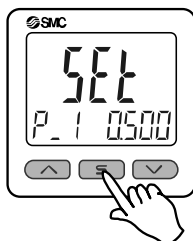

In the simple setting mode, the set value, hysteresis and delay time can be changed while checking the current pressure value (main display).

- (1) Press and hold the  button between 1 and 3 seconds in measurement mode. [SEt] is displayed on the main display. When the button is released while in the [SEt] display, the current pressure value is displayed on the main display, [P\_1] or [n\_1] is displayed on the sub display (left), and the set value is displayed on the sub display (right) (Flashing).



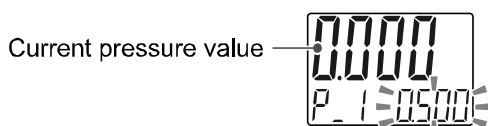

- (2) Change the set value with  or  button, and press the  button to set the value. Then, the setting moves to hysteresis setting. (The snap shot function can be used. (Refer to page 60.))





- (3) Change the set value with  or  button, and press the  button to set the value. Then, the setting moves to the delay time of the switch output. (The snap shot function can be used. (Refer to page 60.))



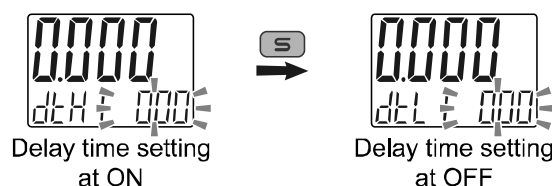

- (4) The delay time of the switch output can be selected by pressing the  or  button at the ON and OFF point of the switch output.  
Delay time setting can prevent the output from chattering.  
The delay time can be set in the range 0.00 to 60.00 sec. in 0.01 sec. increments.



- (5) Press the  button for 2 seconds or longer to complete the setting.  
(If the button is pressed for less than 2 seconds, the setting will moves to the OUT2 setting.)

\*1: Selected items (1) to (4) become valid after pressing the  button.

\*2: After enabling the setting by pressing the  button, it is possible to return to measurement mode by pressing the  button for 2 seconds or longer.

\*3: When the output mode (refer to page 34) is set to error output or output OFF, the simple setting mode cannot be used.  
(The setting changes to measurement mode by releasing the button when [SEt] is displayed.)

\*4: When OUT2 set items are displayed on the sub screen of the measurement mode, step (1) will begin with the OUT2 setting [P\_2] or [n\_2].

In the window comparator mode, set P1L, the lower limit of the switch operation, and P1H, the upper limit of the switch operation, WH1 (hysteresis) and dt1 (delay time) following the instructions given on page 28. (When reversed output is selected, the sub display (left) shows [n1L] and [n1H].) Please refer to the "List of output modes" on page 36 for the relationship between the set values and operation.

\*: Set OUT2 in the same way.

# Function Selection Mode

## ■Function selection mode

In measurement mode, press the **[S]** button between 3 and 5 seconds, to display [F 0]. Select to display the function to be changed [F□□]. Press and hold the **[S]** button for 2 seconds or longer in function selection mode to return to measurement mode.

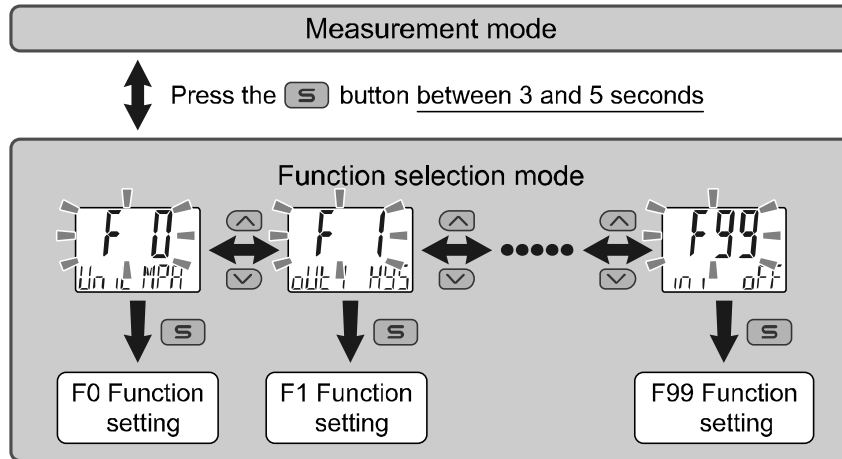

\*: Some products do not have all the functions. If no function is available or selected due to configuration of other functions, [- -] is displayed on the sub display (right).

## ■Default setting

The default setting is as follows.  
 If no problem is caused by this setting, keep these settings.  
 To change a setting, enter function selection mode.

●[F 0] Display units, switch output specifications and diagnostic information selection function ➡ [Page 32](#)

Units specification	Pressure range	Default setting
"Nil" or M	ISE20C(H)	MPa
	ZSE20C(F)	kPa
P	ISE20C(H)	psi
	ZSE20C(F)	

Item	Default setting
Switch output specifications	PNP
Diagnostic information	ALL

•[F 1] Setting of OUT1 ➡ Page 34

Item	Explanation	Default setting
Output mode	Either hysteresis mode, window comparator mode, error output or output off can be selected.	Hysteresis mode
Reversed output	Selects which type of switch output is used, normal or reversed.	Normal output
Pressure setting	Sets the ON and OFF point of the switch output.	ISE20C : 0.500 MPa ZSE20C : -50.5 kPa ZSE20CF : 50.0 kPa ISE20CH : 1.000 MPa
Hysteresis	Appropriate setting of the hysteresis will prevent the switch output from chattering.	ISE20C : 0.050 MPa ZSE20C : 5.1 kPa ZSE20CF : 5.0 kPa ISE20CH : 0.100 MPa
Delay time	Delay time of the switch output can be selected.	0.00 sec
Display color	Selects the output according to the display color.	OUT1 ON : Green OUT1 OFF: Red

•[F 2] Setting of OUT2 ➡ Page 37

Same setting as [F 1] OUT1.

•Other parameter settings

Item	Page	Default setting
[F 3] Digital filter setting	Page 39	0.00 s
[F 4] Auto-preset function	Page 40	Not used
[F 6] Fine adjustment of display value	Page 42	0%
[F10] Sub display setting	Page 43	std (Standard)
[F11] Display resolution setting	Page 49	1000-split
[F14] Zero cut-off setting	Page 50	0.0
[F80] Power saving mode	Page 51	OFF
[F81] Security code	Page 52	OFF
[F90] Setting of all functions	Page 54	OFF
[F96] Number of pressurizing errors	Page 56	-
[F98] Output check	Page 57	N/A (normal output)
[F99] Reset to default settings	Page 59	OFF



■ [F 0] Display units, switch output specifications and diagnostic information selection function

This setting is only available for models with the units selection function.

The unit that can be displayed is different depending on the pressure range.



(kPa/MPa can still be selected if the product does not have the units selection function.)

<Operation>

Press the  or  button in function selection mode to display [F 0].

Press the  button.  Move on to display unit selection.

**Display unit selection**

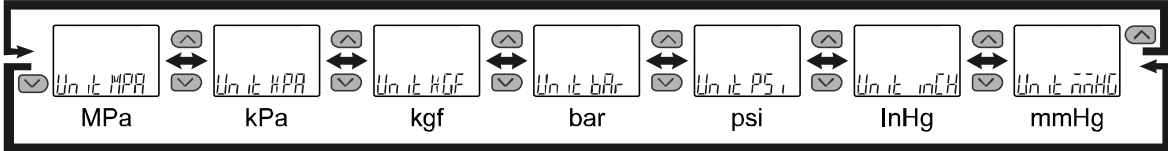

Press the  or  button to select the display unit.







Press the  button to set.  Move on to the switching setting of switch output NPN/PNP specifications.

**Switching setting of switch output NPN/PNP specifications**

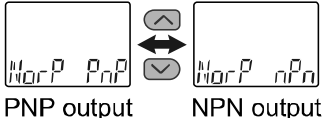
The switch output of this product can be switched to NPN or PNP output in accordance with the user device construction.

Press the  or  button to select switch output specification.



Press the  button to set.  Move to the setting of diagnostic information selection.

### Setting of diagnostic information selection

It is possible to set the condition in which the diagnostic information of the process data can be transferred to the upper devices such as a master.

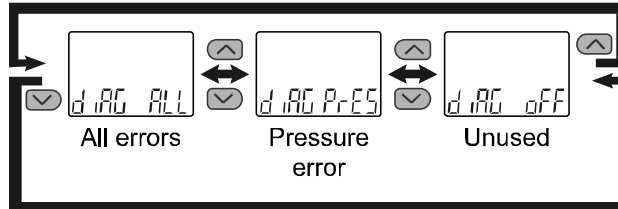

- \*: IO-Link mode can provide the communication function.
- \*: Refer to page 65 for details of the diagnostic information.

Press the  button to set.  Return to function selection mode.

[F 0] Display units, switch output specifications and diagnostic information selection function completed

#### • Available display unit and minimum set value

Unit	ZSE20CF	ZSE20C	ISE20C	ISE20CH
MPa	0.001	0.001	0.001	0.001
kPa	0.1	0.1	1	1
kgf/cm <sup>2</sup>	0.001	0.001	0.01	0.01
bar	0.001	0.001	0.01	0.01
psi	0.02	0.01	0.1	0.2
InHg	0.1	0.1	-	-
mmHg	1	1	-	-

## ■[F 1] Setting of OUT1

Set the output mode of OUT1.

Output turns on when the pressure is greater than the set value. The default setting is to turn on the pressure switch when the pressure reaches the center of the atmospheric pressure and upper limit of the rated pressure range.

The display color changes according to the OUT1 output status. It will turn Green when the output is ON and it will be Red when the output is OFF.

Please refer to the "List of output modes" on page 36 for the relationship between the set items and operation.

### <Operation>

Press the or button in function selection mode to display [F 1].

Press the button. Move on to output mode setting.

**Output mode setting**

Press the or button to select the required output mode.

OUT 1 H45

Hysteresis

OUT 1 W ind

Window comparator

OUT 1 Err

Error output

OUT 1 off

Output OFF

Press the button to set. Move on to reversed output setting.

**Reversed output setting**

Press the or button to select the reversed output.

lot 1 LP

Normal output

lot 1 Ln

Reversed output

Press the button to set. Move on to pressure setting.

**Pressure setting**

Set the pressure based on the setting method on page 26.

Hysteresis mode: [P\_1]  
 Window comparator mode: [P1L] [P1H]  
 "P" is changed to "n" as [P\_1] → [n\_1] when reversed output is selected.  
 The snap shot function can be used.  
 (Refer to page 60.)

[Err] Error output is selected

Press the button to move on to display color setting.

Press the button to set. Move on to hysteresis setting.

[OFF] Output off is selected  
 Press the button to move on to display color setting.

-34-

No.PS※※-OMX0002-A

### Hysteresis setting

Set the pressure referring to the setting method on page 26.



Hysteresis mode: [H\_1]  
Window comparator mode: [WH1]  
The snap shot function can be used. (Refer to page 60.)

Press the **S** button to set. Move on to delay time setting.

### Delay time setting

Set the delay time referring to the setting method on page 28.



Delay time setting at ON



Delay time setting at OFF

Press the **S** button to set. Move on to display color setting.

### Display color setting

Press the **▲** or **▼** button to select the display color.



<b>col 1500</b>	<b>col 150r</b>	<b>col 2500</b>	<b>col 250r</b>	<b>col red</b>	<b>col grn</b>
ON: Green OFF: Red (Linked to OUT1)	ON: Red OFF: Green (Linked to OUT1)	ON: Green OFF: Red (Linked to OUT2)	ON: Red OFF: Green (Linked to OUT2)	Normally: Red	Normally: Green

Press the **S** button to set. Return to function selection mode.

[F 1] Setting of OUT1 completed

\*1: Selected item becomes valid after pressing the **S** button.

\*2: After enabling the setting by pressing the **S** button, it is possible to return to the measurement mode by keeping pressing the **S** button for 2 seconds or longer.

•List of output modes

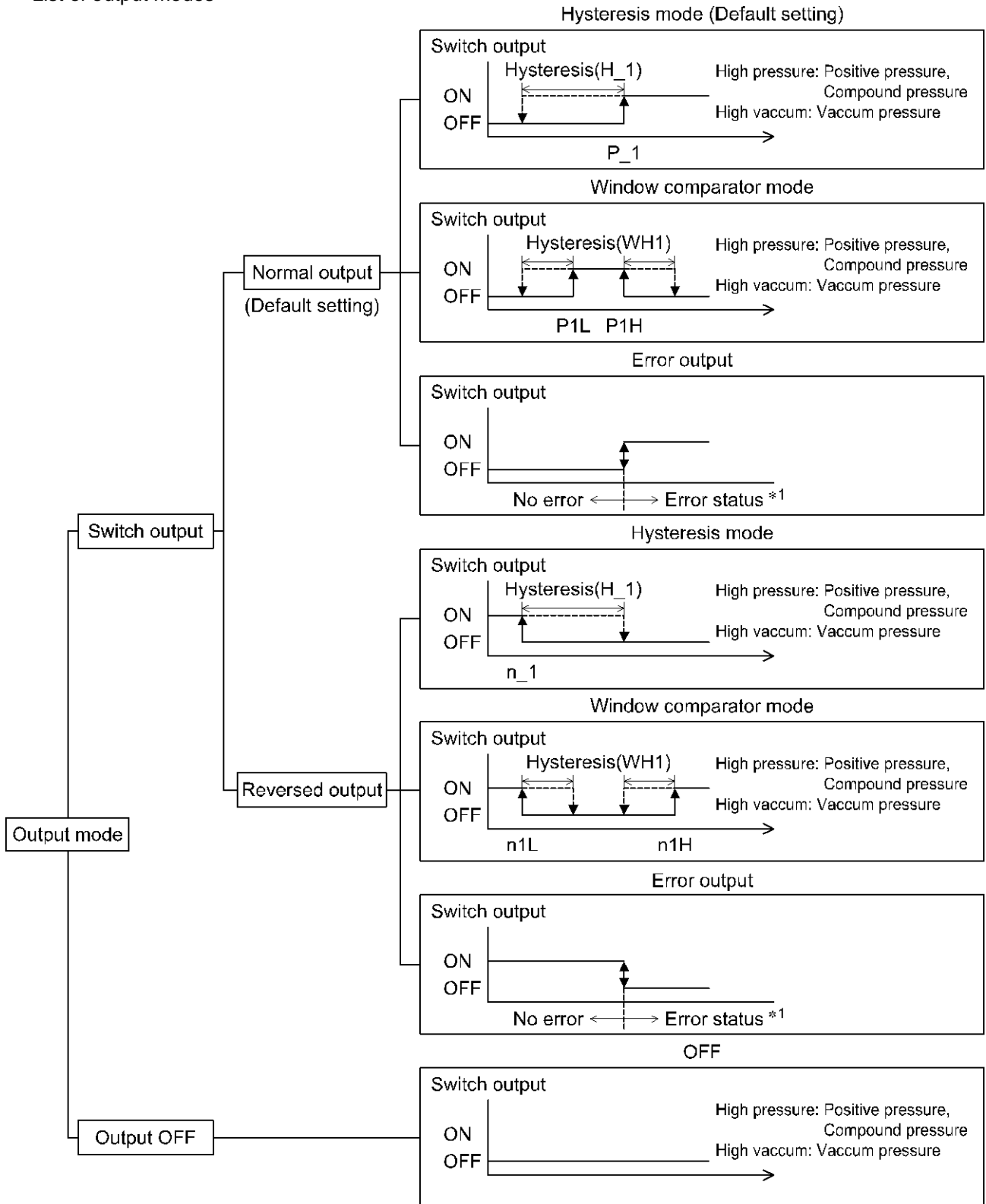

\*1: The applicable errors are Er6, 8, 9, 15 as well as Er1 (excluding the error output).

\*: The chart above shows the OUT1 operation. For OUT2, all "1" in the chart will be changed to "2". (example P<sub>1</sub>→P<sub>2</sub>)

If the point at which the switch output changes is outside of the set pressure range due to the selection of normal or reversed output, the hysteresis value is automatically adjusted.

■ [F 2] Setting of OUT2 (Setting of the OUT2 output available in the IO-Link communication process data)

Set the output mode of OUT2.

Output turns on when the pressure is greater than the set value. The default setting is to turn on the pressure switch when the pressure reaches the center of the atmospheric pressure and upper limit of the rated pressure range.

Please refer to the "List of output modes" on page 36 for the relationship between the set items and operation.

<Operation>

Press the or button in function selection mode to display [F 2].

Press the button. Move on to output mode setting.

**Output mode setting**

Press the or button to select the required output mode.

Press the button to set. Move on to reversed output setting.

**Reversed output setting**

Press the or button to select the reversed output.

Press the button to set. Move on to pressure setting.

**Pressure setting**

Set the pressure based on the setting method on page 26.

Hysteresis mode: [P\_2]  
 Window comparator mode: [P2L] [P2H]  
 "P" is changed to "n" as [P\_2] → [n\_2] when reversed output is selected.  
 The snap shot function can be used.  
 (Refer to page 60.)

Press the button to set. Move on to hysteresis setting.

[OFF] Output off is selected  
 Press the button to move on to display color setting.

[Err] Error output is selected  
 Press the button to move on to display color setting.

### Hysteresis setting

Set the pressure referring to the setting method on page 26.



Hysteresis mode: [H\_2]  
Window comparator mode: [WH2]  
The snap shot function can be used. (Refer to page 60.)

Press the **S** button to set. Move on to delay time setting.

### Delay time setting

Set the delay time referring to the setting method on page 28.



Delay time setting at ON



Delay time setting at OFF

Press the **S** button to set. Move on to display color setting.

### Display color setting

Press the **▲** or **▼** button to select the display color.



<b>Col 15or</b>	<b>Col 15or</b>	<b>Col 25or</b>	<b>Col 25or</b>	<b>Col red</b>	<b>Col grn</b>
ON: Green OFF: Red (Linked to OUT1)	ON: Red OFF: Green (Linked to OUT1)	ON: Green OFF: Red (Linked to OUT2)	ON: Red OFF: Green (Linked to OUT2)	Normally: Red	Normally: Green

Press the **S** button to set. Return to function selection mode.

[F 2] Setting of OUT2 completed



\*1: Selected item becomes valid after pressing the **S** button.



\*2: After enabling the setting by pressing the **S** button, it is possible to return to the measurement mode by keeping pressing the **S** button for 2 seconds or longer.

## ■[F 3] Digital filter setting



The Digital filter can be selected to filter the pressure measurement.  
Output chattering or flicker in the measurement mode display can be reduced by setting the digital filter.  
Digital filter can be set in 0.01[sec.] increment in the range of 0.00 to 30.00 sec.

### <Operation>

Press the  or  button in function selection mode to display [F 3].

Press the  button.  Move on to digital filter setting.

### Digital filter setting

Press the  or  button to select the digital filter.



Press the  button to set.  Return to function selection mode.

[F 3] Digital filter setting completed

\*1: Each set value is a guideline for 90% response time.

\*2: Both the switch output and pressure display are affected. When only switch output needs to be affected, select the delay time setting (page 28, 35 and 38).



## ■[F 4] Auto-preset function



This function will automatically calculate and set the optimum pressure based on the actual operating condition, when hysteresis mode has been selected.

### <Operation>

Press the  or  button in function selection mode to display [F 4].

Press the  button.  Move on to Auto-preset function.

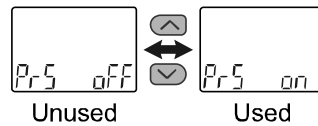

### Auto-preset function

Press the  or  button to select the auto-preset function.



Press the  button to set.  Return to function selection mode.

[F 4] Auto-preset function completed

Press the  button in measurement mode to perform the pressure setting.  
Then, press the  button again to change the pressure while the display is flashing.  
(Refer to page 41 for details.)

●Auto-preset

When auto-preset is selected in function selection mode, the set value can be calculated and memorized from the measured pressure. Repeating the suction and release of the workpiece to be set for several times will automatically optimize the set value.

(1) Selection of auto-preset OUT1 mode

Press the **S** button in measurement mode to display [AP1 REdY].  
 (If setting of OUT1 is not necessary, select [AP1 REdY], and then press the **▲** and **▼** buttons simultaneously for 1 second or longer.  
 The display will move to [AP2 REdY]).



Auto-preset is ready

(2) Preparation of equipment for OUT1

Prepare the equipment for which the pressure of OUT1 is to be set.

(3) Setting of auto-preset for OUT1

Press the **S** button, [AP1 RUn] will be displayed.  
 Measurement starts. Operate the device to change the pressure.  
 (If the **▲** and **▼** buttons are pressed simultaneously for 1 second or longer while [AP1 RUn] is displayed, measurement will be stopped and [AP2 REdY] will return).



Auto-preset is being set

(4) Selection of auto-preset OUT2 mode

Press the **S** button to set [P\_1],[H\_1] ([n\_1],[H\_1] in reverse output mode) to display [AP2 REdY].  
 (If the setting of OUT2 is not necessary, press the **▲** and **▼** buttons simultaneously for 1 second or longer after [AP2 REdY] display. The display will move to measurement mode).

(5) Preparation of equipment for OUT2

Prepare equipment for which the pressure of OUT2 is to be set, and set the value of OUT2 as in OUT1.  
 [AP2 RUn] will be displayed and measurement will start.  
 (If the **▲** and **▼** buttons are pressed simultaneously for 1 second or longer while "AP2 RUn" is displayed, measurement will be stopped and measurement mode will return).

(6) Complete setup

Press the **S** button to set the set value of [P\_2] and [H\_2] and complete the auto-preset mode. Then, measurement mode returns.  
 ([n\_2], [H\_2] in reverse output mode.)

The settings in auto-preset will be as follows in OUT1.

<p>•Normal output</p> <p><math>P_1 = A - (A - B)/4</math></p> <p><math>H_1 =  (A - B)/2 </math></p>	<p>•Reversed output</p> <p><math>n_1 = B + (A - B)/4</math></p> <p><math>H_1 =  (A - B)/2 </math></p>	<p>A = Maximum pressure</p> <p>B = Minimum pressure</p>
---	---	---

In the OUT2 setting, the above P\_1, n\_1 and H\_1 will be P\_2, n\_2 and H\_2 respectively.



If setting is not necessary press the **▲** and **▼** buttons simultaneously for 1 second or longer.

## ■[F 6] Fine adjustment of display value

This function is to manually perform a fine adjustment of the displayed pressure value.  
Pressure can be adjusted in the following range of  $\pm 5\%$ R.D.

### <Operation>

Press the  or  button in function selection mode to display [F 6].

Press the  button.  Move on to fine adjustment of display value.

#### Fine adjustment of display value

Press the  or  button to change adjustment rate.

When adjustment rate is changed, the pressure value after the adjustment will be displayed on the main screen.

Pressure after adjustment



Adjustment rate

Press the  button to set.  Return to function selection mode.

[F 6] Fine adjustment of display value completed

## ■[F10] Sub display setting

Change the display style of the sub display.  
Detailed contents are shown in the pages from 44.

### <Operation>

Press the or button in function selection mode to display [F10].

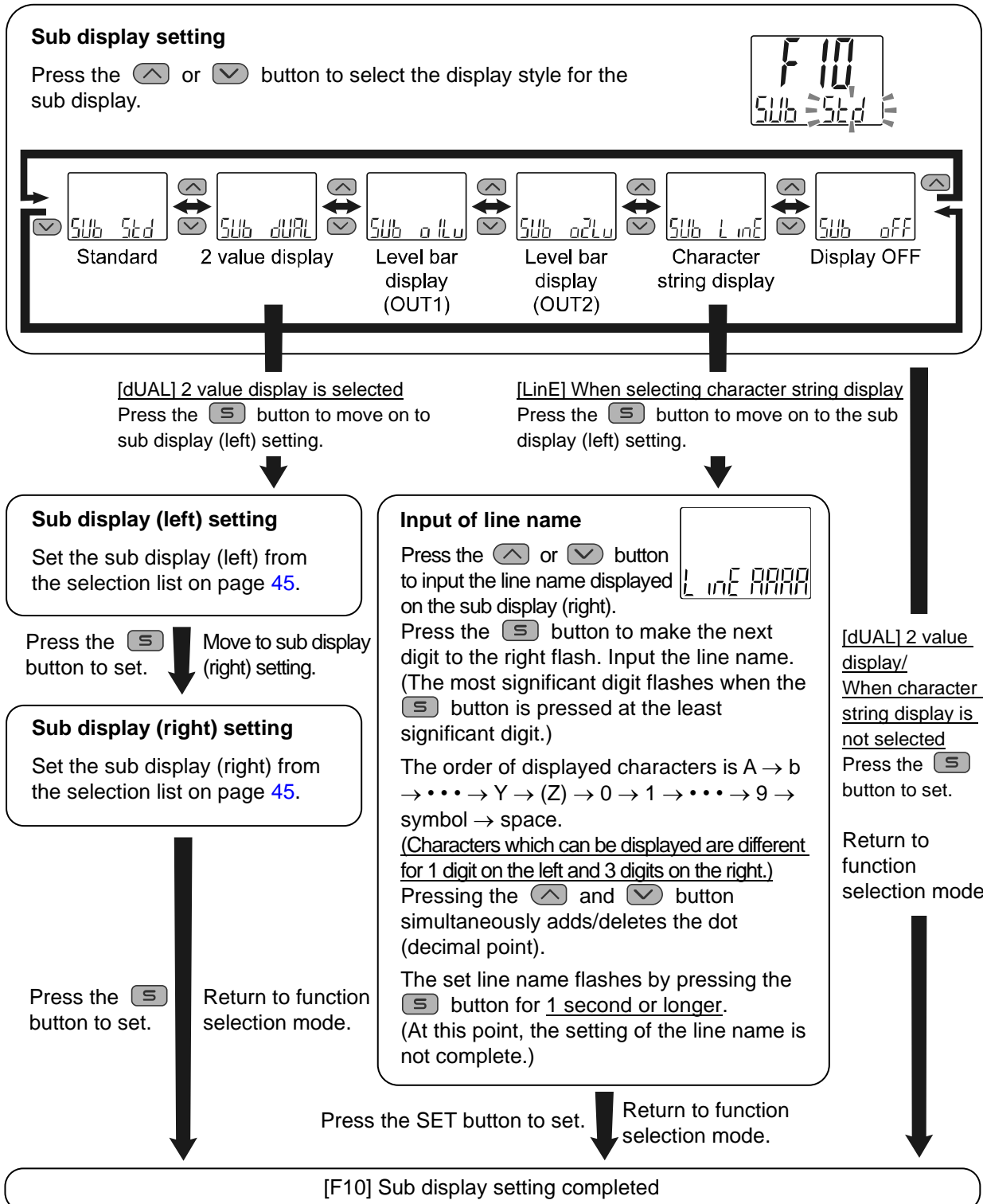

Press the button. Move on to sub display setting.



## <Sub display>

### •Standard

The Standard display function displays the items and values on the sub display.

The displayed item varies depending on the setting of the output mode. Select the displayed items by pressing the  or  button in measurement mode.

(Hysteresis mode, error output, switch output off)

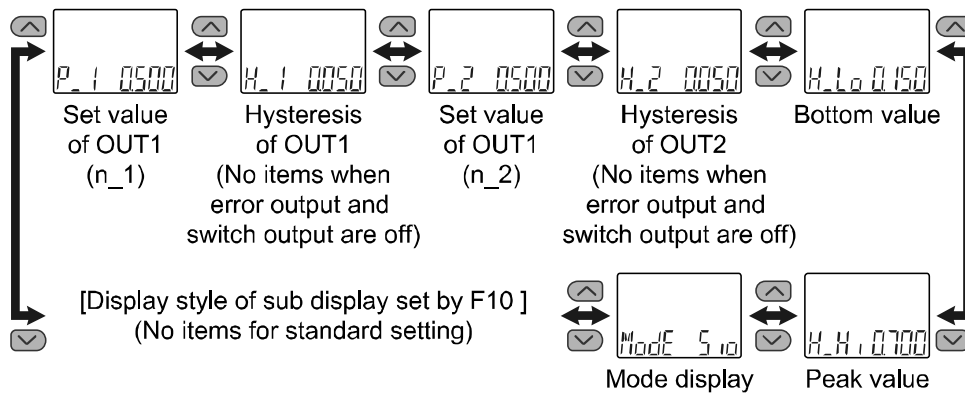

(Window comparator mode)

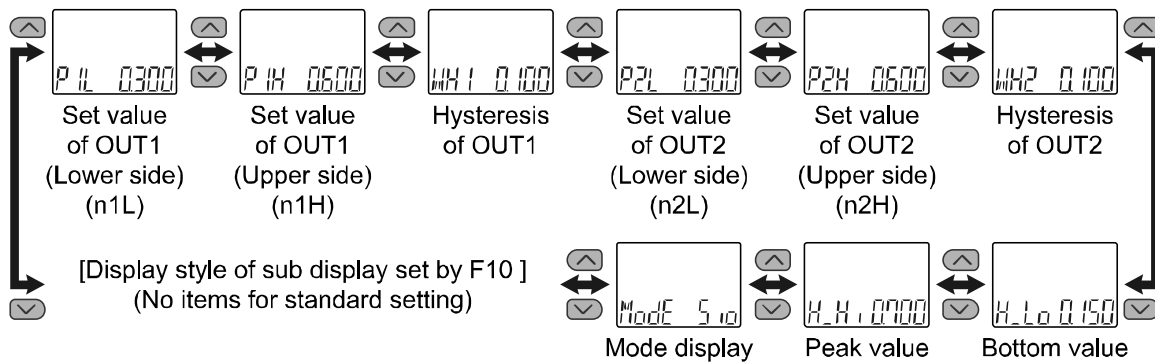

•2 value display

The 2 value display function displays the items listed below on the right and left side of the sub display.





List of items for selection

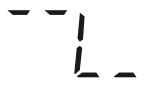

Item	Details	Sub display		Remarks
		Left side	Right side	
P <sub>1</sub> (n <sub>1</sub> )	Set value for OUT1 hysteresis mode	○	○	When hysteresis mode is selected
H <sub>1</sub>	OUT1 hysteresis mode	○	○	When hysteresis mode is selected
P <sub>1L</sub> (n <sub>1L</sub> )	OUT1 Window comparator mode set value (Lower side)	○	○	When window comparator mode is selected
P <sub>1H</sub> (n <sub>1H</sub> )	OUT1 Window comparator mode set value (Upper side)	○	○	When window comparator mode is selected
WH <sub>1</sub>	OUT1 window comparator mode	○	○	When window comparator mode is selected
P <sub>2</sub> (n <sub>2</sub> )	Set value for OUT2 hysteresis mode	○	○	When hysteresis mode is selected
H <sub>2</sub>	OUT2 hysteresis mode	○	○	When hysteresis mode is selected
P <sub>2L</sub> (n <sub>2L</sub> )	OUT2 Window comparator mode set value (Lower side)	○	○	When window comparator mode is selected
P <sub>2H</sub> (n <sub>2H</sub> )	OUT2 Window comparator mode set value (Upper side)	○	○	When window comparator mode is selected
WH <sub>2</sub>	OUT2 window comparator mode	○	○	When window comparator mode is selected
H <sub>H1</sub>	Pressure peak value	○	×	
H <sub>L0</sub>	Pressure bottom value	×	○	
Unit	Pressure display unit	○	○	
RRnG	Rated pressure range	○	○	
Mod1	OUT1 output mode/output style	○	×	
Mod2	OUT2 output mode/output style	×	○	
oUt	NPN/PNP output set value	○	○	
LinE	String of random characters	○	○	
oFF	Display OFF	○	○	

Table showing the rated pressure range when RAnG is selected.

Pressure range	Rated pressure	Characters displayed on the sub display
Vacuum pressure	-100 kPa	PACU
Compound pressure	100 kPa	Con 1
Positive pressure	1 MPa	P 10
Positive pressure	2 MPa	P 20

Table showing the output mode and output form when Md1 and Md2 are selected.

Output mode	Output style	Display style
Hysteresis mode	Normal output	
	Reversed output	
Window comparator mode	Normal output	
	Reversed output	
Error output	Normal/Reversed output	
Switch output off	-	

When using the 2 value display function, 3 step setting is not available for the display.  
 (When setting 3 step, select each set value to be displayed by pressing the  or  button.)

When output operation mode is changed after selecting the 2 value display, the selected display items will not be applicable and [- -] will be displayed. In this case, select items for the 2 value display setting again.

•Level bar display

The Level bar display is a function used to visualize the pressure and the ON area for the switch output on the sub display.

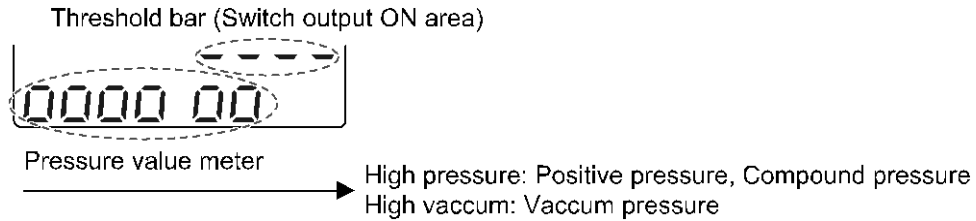

The display style varies depending on the setting of the output mode.

(In hysteresis mode or window comparator mode)

The threshold bar displaying the switch output ON area is displayed according to the table below, using the output mode.

(During error output or when the output is off)

The threshold bar will not be displayed. Only the pressure value meter is displayed.

Output mode	Output style	Threshold bar display style
Hysteresis mode	Normal output	P_1
	Reversed output	n_1
Window comparator mode	Normal output	P1L P1H
	Reversed output	n1L n1H
Error output	Normal/Reversed output	No indication
Switch output off	-	No indication

The Level bar display resolution (pressure for one "O") varies depending on the output mode.

Output mode	Display resolution
Hysteresis mode	1/10 of P_1(n_1), P_2(n_2)
Window comparator mode	1/4 of P1H-P1L(n1H-n1L), P2H-P2L(n2H-n2L)
Error output	Positive pressure, vacuum pressure: Rated maximum pressure - 1/7 of the atmospheric pressure Compound pressure: Rated maximum pressure - 1/4 of the atmospheric pressure
Switch output off	Positive pressure, vacuum pressure: Rated maximum pressure - 1/7 of the atmospheric pressure Compound pressure: Rated maximum pressure - 1/4 of the atmospheric pressure



During an error output or when the output setting is off, the pressure value meter at the atmospheric pressure is displayed according to the table below.

Rated range	Display at atmospheric pressure	
Vacuum pressure	0	or 00
Compound pressure	0000	or 0000 0
Positive pressure	0	or 00

**•Character string display**

Function to display the specified character string on the sub-screen.

When line name is input, characters which can be displayed for each digit are as follows.

(Pattern for 3 digits on the right)

Characters Q, X, Z, /, or \* cannot be displayed.

A	B	C	D	E	F	G	H	I	J	K	L	M	N	O	P	R	S	T	U	V	W	Y
A	b	C	d	E	F	G	H	I	J	K	L	M	N	O	P	r	S	t	U	v	w	y
0	1	2	3	4	5	6	7	8	9	Symbol	Space	(Dot)										
0	1	2	3	4	5	6	7	8	9	_	-	.										

(Pattern for 1 digit on the left)

Characters A to Z can be displayed (the same as the 3 digits on the right).

A	B	C	D	E	F	G	H	I	J	K	L	M	N	O	P	Q	R	S	T	U	V	W	X	Y	Y
A	b	C	d	E	F	G	H	I	J	K	L	M	N	O	P	Q	R	S	t	U	v	w	X	Y	Z
												<Pattern for 3 digits on the right>													
0	1	2	3	4	5	6	7	8	9	Symbol		K	M	N	R	V	W	Space	(Dot)						
0	1	2	3	4	5	6	7	8	9	_	-	/	#	P	N	r	w	.							



**•Display OFF**



The Sub display is not displayed.

## ■[F11] Display resolution setting



This function is to change the pressure display resolution.  
The flicker of the display can be reduced.

### <Operation>

Press the  or  button in function selection mode to display [F11].

Press the  button.  Move on to display resolution setting.

### Display resolution setting

Press the  or  button to select the display resolution.

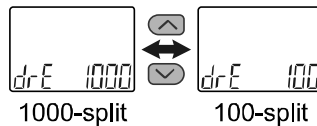

Press the  button to set.  Return to function selection mode.

[F11] Display resolution setting completed

\*: It may not be possible to change the resolution depending on the unit of pressure selected.

The units that allow display resolution to be selected are [MPa], [kPa(ZSE20C(F) only)], [kgf/cm<sup>2</sup>], [bar], [psi] and [inHg]

(The units [kgf/cm<sup>2</sup>], [bar], [psi] and [inHg] can only be set when using a product with units selection function.)

➡ Page 32 [F 0] Display units, switch output specifications and diagnostic information selection function

## ■[F14] Zero cut-off setting

When the pressure display value is close to zero, the product rounds the value and zero will be displayed. The zero cut-off range is 0.0 to 10.0% F.S., and can be set in 1.0% F.S. increments.

### <Operation>

Press the or button in function selection mode to display [F14].

Press the button. Move on to select zero cut-off setting.

### Select zero cut-off setting

Press the or button to select the value of zero cut-off.

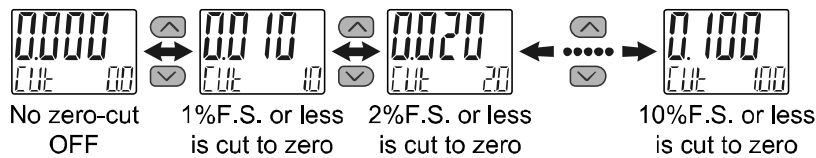

- \*: The display above is an example of when [MPa] is selected for the ISE70 (1 MPa range) with the unit switching function.
- \*: When the actual pressure is smaller than the displayed value in the upper line, zero will be displayed.

Example: 1 MPa range P<sub>1</sub> = 0.015 [MPa], H<sub>1</sub> = 0.01 [MPa], zero cut-off 1.0%

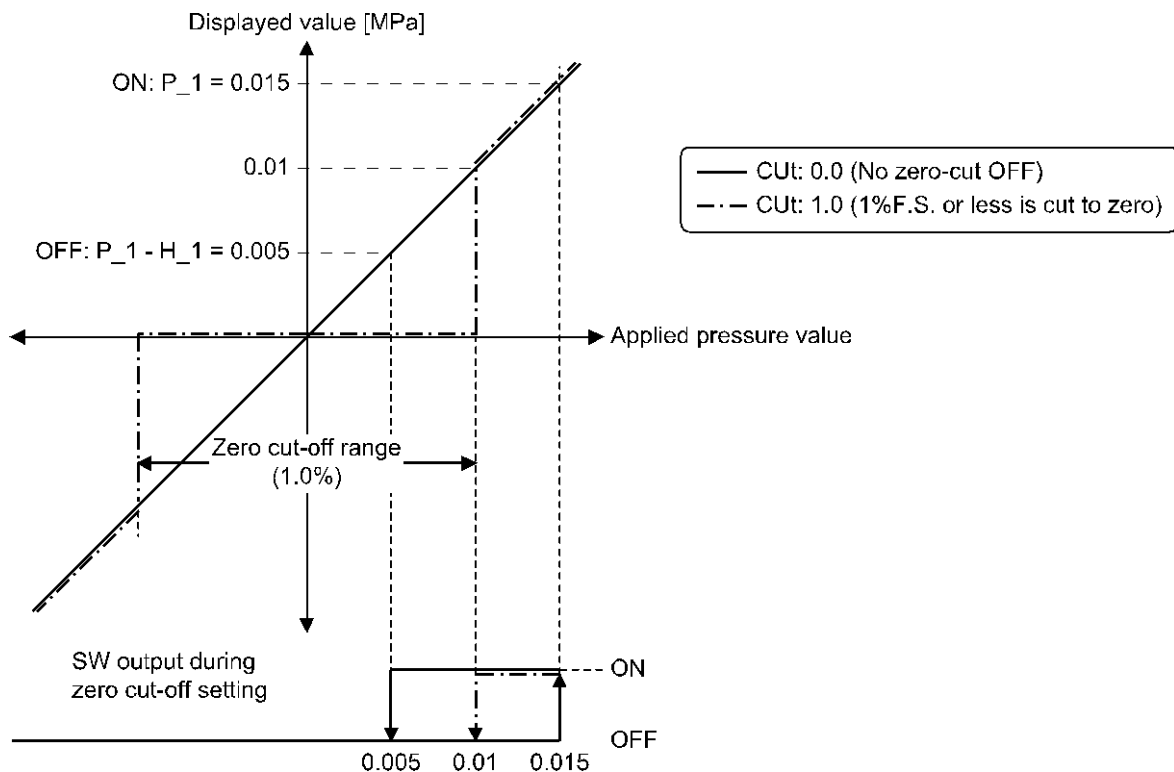

Press the button to set. Return to function selection mode.



[F14] Zero cut-off setting completed



## ■[F80] Power saving mode

Power saving mode can be selected.



When selected and no buttons are pressed for 30 seconds, the pressure switch will shift to power saving mode.

### <Operation>

Press the  or  button in function selection mode to display [F80].

Press the  button.  Move on to power saving mode.

### Power saving mode

Press the  or  button to select the power saving mode.

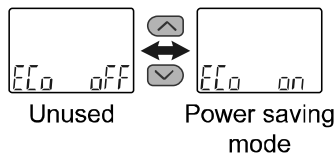

Press the  button to set.  Return to function selection mode.

[F80] Power saving mode completed

In power saving mode, when buttons are pressed the display is normal, but if no buttons are pressed for 30 seconds, it will revert to power saving mode. (Power saving is only enabled in measurement mode)

During power saving mode, [ECo] will flash in the sub display and the operation light is ON (only when the switch is ON).



At switch ON





At switch OFF

## ■[F81] Security code



The security code can be turned on or off and the security code can be changed when unlocked.

### <Operation>

Press the  or  button in function selection mode to display [F81].

Press the  button.  Move on to security code.

#### Security code

Press the  or  button to select the setting of security code.

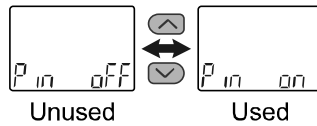

[on] (use) is selected



Press the  button to set.

 Move on to security code checking.

[oFF] (not use) is selected

Press the  button to return to function selection mode.

#### Security code checking

Press the  or  button to input the security code on the sub display (right).  
(The default setting is [000].) \*

For instructions on how to enter the security code, refer to "How to input and change the security code" on page 63.

If the security code entered is incorrect, [FAL] will be displayed, and the security code must be entered again.

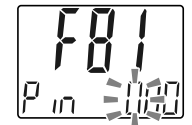

If the wrong security code is entered 3 times, [nG] is displayed and the device returns to function selection mode.







Press the  button for 1 second to set.

 Move on to security code changing.

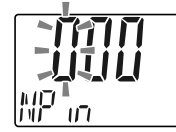
### Security code changing

Press the  or  button to input the changed security code on the main display. \*  
For instructions on how to enter the security code, refer to "How to input and change the security code" on page 63.



After entry, the changed security code will flash by pressing the  button for 1 second.  
(At this point, the changing of the security code is not completed)  
Return to the change of setting again by pressing the  or  button.



Press the  button to set.  Return to function selection mode.

[F81] Security code completed

If the security code function is enabled, it is will be necessary to input a security code to release the key-lock.



\*: If a key is not pressed for 30 seconds while entering the security code, function selection mode will return.

● **Special function setting**

■ **[F90] Setting of all functions**



All functions can be set in turn.

<Operation>

Press the  or  button in function selection mode to display [F90].

Press the  button.  Move on to setting of all functions.

**Setting of all functions**

Press the  or  button to select all functions.



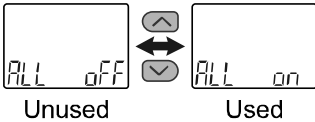

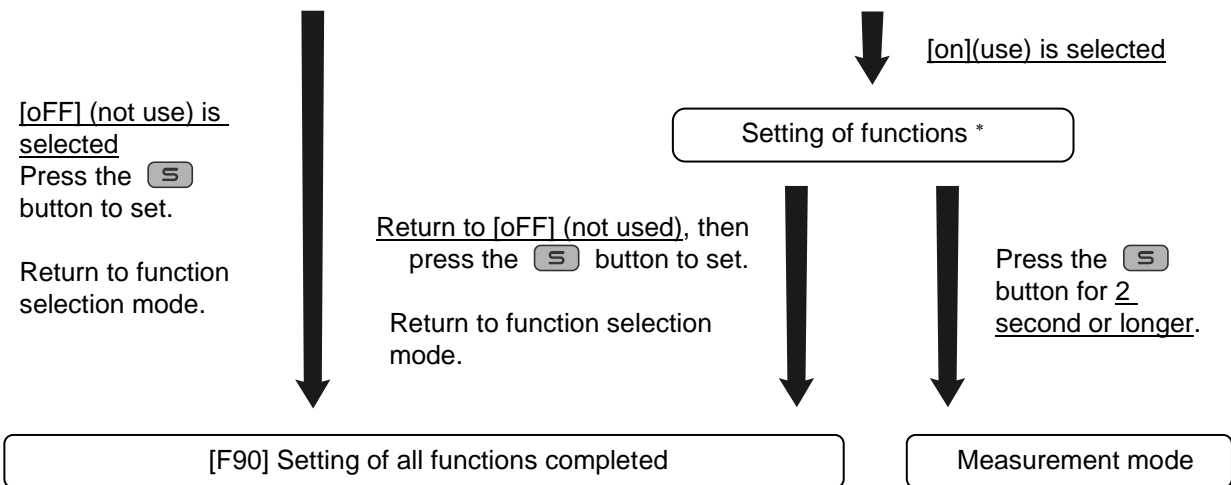

\*: Setting of each function

Every time the  button is pressed, the display moves to the next function in order of "Setting of each function" on page 55.

Set by using the  and  buttons.

For details of how to set each function, refer to the relevant setting of function section in this manual.

● Setting of each function

Order	Function
1	Display unit selection
2	Switching setting of switch output NPN/PNP specifications
3	Setting of diagnostic information selection
4	Output mode setting of OUT1
5	Reversed output setting of OUT1
6	Pressure setting of OUT1
7	Hysteresis setting of OUT1
8	Set OUT1 delay time at ON
9	Set OUT1 delay time at OFF
10	Display color setting
11	Output mode setting of OUT2
12	Reversed output setting of OUT2
13	Pressure setting of OUT2
14	Hysteresis setting of OUT2
15	Set OUT2 delay time at ON
16	Set OUT2 delay time at OFF
17	Display color setting
18	Digital filter setting
19	Auto-preset function
20	Fine adjustment of display value
21	Sub display setting
22	Display resolution setting
23	Zero cut-off setting
24	Power saving mode
25	Security code

\*: Measurement mode can return from any setting item by pressing the  button for 2 seconds or longer.



\*: Function set before returning to the measurement mode is maintained.





## ■[F96] Number of pressurizing errors

When the pressure has exceeded 115% of the rated pressure, this is counted as a pressurizing error.

### <Operation>

Press the  or  button in function selection mode to display [F96].

Press the  button.  Move on to number of pressurizing errors.

**Number of pressurizing errors**





\*: The maximum number of pressurizing error is 1000 counts.

\*: The number of pressurizing errors counted cannot be cleared.

## ■[F98] Output check



Correct operation of the switch output can be confirmed.  
The output can be turned ON/OFF manually.

### <Operation>

Press the  or  button in function selection mode to display [F98].

Press the  button.  Move on to output check.

#### Output check

Press the  or  button to select output check.

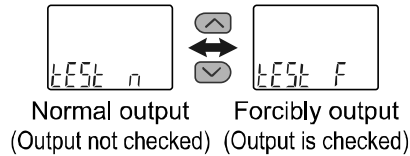

[F] (Forced output) is selected  
Press the  button.

 Move on to OUT1 output check.

[n] (Normal output) is selected  
Press the  button to set.

Return to function selection mode.



#### OUT1 output check

Press the  or  button to select OUT1 output check.

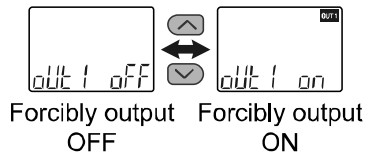

Press the  button.

 Move on to OUT2 output check.



### OUT2 output check

Press the or button to select OUT2 output check.

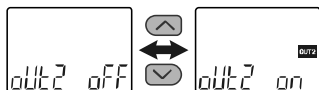

Forcibly output OFF      Forcibly output ON

Press the button to set.

### Diagnostic output check (using the IO-Link communication only)

Press the or button to select the diagnostic output check.

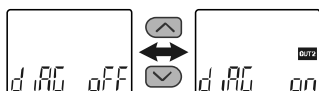

Forcibly output OFF      Forcibly output ON

\*: IO-Link mode can provide the communication function.  
\*: Refer to page 65 for details of the diagnostic information.

Press the button to set.

### PD measurement value (using the IO-Link communication only)

The upper and lower limit values of the rated pressure value can be output compulsively as PD measurement value (process data). Press the or button to select the lower or upper limit value.

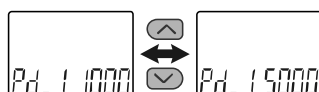

Output of the PD measurement value is OFF at the rated lower limit value      Output of the PD measurement value is OFF at the rated upper limit value

\*: IO-Link mode can provide the communication function.  
\*: Refer to page 65 for details of the PD measurement value.

Press the button to return to [n] (Normal output), then press the button to set.

Return to function selection mode.

[F98] Output check completed

\*: Measurement mode can return from any setting item by pressing the SET button for 2 seconds or longer.

## ■[F99] Reset to default settings



If the product settings are uncertain, the default values can be restored.

### <Operation>

Press the  or  button in function selection mode to display [F99].

Press the  button.  Move on to reset to default settings.

### Reset to default settings

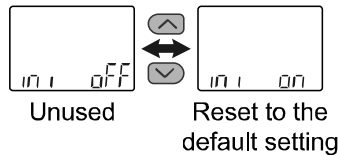

Press the  or  button to select reset to default settings.



[oFF] (not use) is selected  
Press the  button to set.

Return to function selection mode.

[on] (reset to default settings) is selected

Press the  and  buttons simultaneously for 5 second or longer.



All settings are returned to the default values. Return to function selection mode.

[F99] Reset to default settings completed

## Other Settings

### ○ Snap shot function

The current pressure value can be stored to the switch output ON/OFF set point.

When the items of sub display (left) below are selected in 3 step setting mode, simple setting mode or function selection mode ([F 1] Setting of OUT1, [F 2] Setting of OUT2), by pressing the  and  buttons simultaneously for 1 second or longer, the value of the sub display (right) shows [- - -], and the values corresponding to the current pressure values are automatically displayed.

Output mode	Configurable items	Sub display (left)	Snap shot function
Hysteresis mode	OUT1, OUT2 set value	$P_{-1} (n_{-1}), P_{-2} (n_{-2})$	○
	Hysteresis	$H_{-1}, H_{-2}$	○
Window comparator mode	OUT1, OUT2 set value	$P_{1L} (n_{1L}), P_{1H} (n_{1H})$ $P_{2L} (n_{2L}), P_{2H} (n_{2H})$	○
	Hysteresis	$WH_1, WH_2$	x

#### •OUT1 set value and OUT2 set value

The value is set to the same value as the display value (current pressure value).

(There is a range which cannot be set to the current pressure depending on the hysteresis. In that case, the value is set to the closest value.)

#### •Hysteresis

The hysteresis is calculated from the equation below and set.

Normal output: (OUT1(2) set value) - (current pressure value)

Reverse output: (current pressure value) - (OUT1(2) set value)



If the calculation result becomes 0 or less, [Err] is displayed on the sub display (right) and the set value is not changed.

Afterwards, it is possible to adjust the value by pressing the  or  button.

### ○ Peak/bottom value indication

The maximum (minimum) pressure when the power is supplied is detected and updated.



In peak/bottom indication mode, the current pressure is displayed.

Press the  or  button in measurement mode to switch the sub-display (left) to the display shown below.

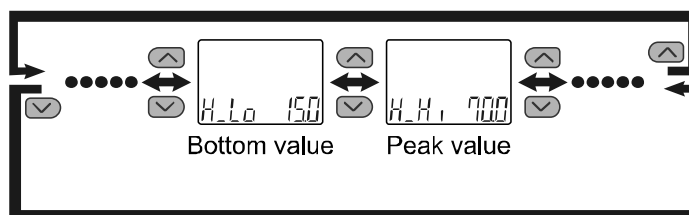
Peak/bottom values are displayed on the sub display (right) at the same time as the current pressure value on the main display.





Peak/bottom values are maintained even if the power supply is cut.

When the  and  buttons are pressed for 1 second or longer simultaneously while the peak/bottom values are displayed, the sub display (right) displays [- - -] and the maximum (minimum) pressure value are cleared.

### ○ Zero-clear function

The displayed value can be adjusted to zero if the pressure being measured is within  $\pm 7\%$ F.S. ( $\pm 3.5\%$ F.S. for compound pressure) of the zero point set at the time of default settings.

(The zero clear range varies by  $\pm 1\%$ F.S. due to variation between individual products.)

In measurement mode, when the  and  buttons are pressed for 1 second or longer simultaneously, the main display shows [- - -], and the reset to zero. The display returns to measurement mode automatically.

## ○Key-lock function

The key-lock function is used to prevent errors occurring due to unintentional changes of the set values. If the **[S]** button is pressed while the keys are locked, [LoC] is displayed on the sub display (left) for approximately 1 second.

(Each setting and peak/bottom values are displayed with **[^]** and **[v]** buttons. In that case, the sub screen will return after 30 seconds.)

### <Operation - Without security code input ->

- (1) Press the **[S]** button for 5 seconds or longer in measurement mode. When [oPE] is displayed on the main display, release the button.

The current setting [LoC] or [UnL] will be displayed on the sub display.

(To release key-lock repeat the above operation.)

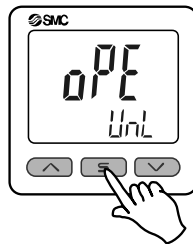

- (2) Select the key-locking/un-locking with **[^]** or **[v]** button, and press the **[S]** button to set.

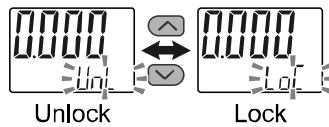

## <Operation – With security code input ->

### •Locking

- (1) Press the **[S]** button for 5 seconds or longer in measurement mode. When [oPE] is displayed on the main display, release the button.

The current setting [LoC] or [UnL] will be displayed on the sub display.



- (2) Select the key [LoC] with **[^]** or **[v]** button, and press the **[S]** button to set.

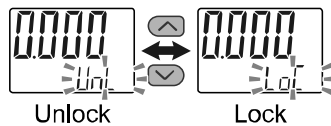

### •Unlocking

- (1) Press the **[S]** button for 5 seconds or longer in measurement mode. When [oPE] is displayed on the main display, release the button.

The current setting [LoC] or [UnL] will be displayed on the sub display.

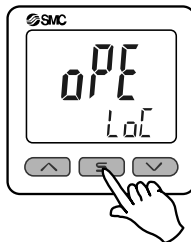

- (2) Select the un-locking [UnL] with **[^]** or **[v]** button. Setting is recognized by pressing the **[S]** button, then security code is required.

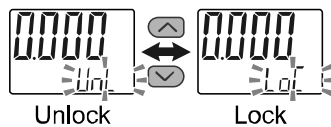

- (3) For instructions on how to enter the security code, refer to "How to input and change the security code" on page 63.

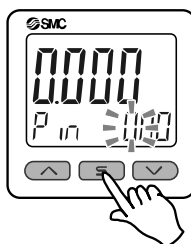



- (4) If inputted security code is correct, the indication of the main display changes to [UnL], and pressing the one of **[^]**, **[S]** or **[v]** button releases key-lock and the measurement mode returns.  
If the security code entered is incorrect, [FAL] will be displayed, and the security code must be entered again. If the wrong security code is entered 3 times, [LoC] is displayed and the device returns to measurement mode.

### •How to input and change the security code

The left most digit starts flashing.

Press the  or  button to select a value.

Press the  button to make the next digit to the right flash.

(If the  button is pressed at the last digit, the first digit will start flashing.)

After the setting is complete, Press and hold the  button for 1 second or longer.

(If an operation is not performed for 30 seconds during input or change of the security code, it will return to measurement mode.)

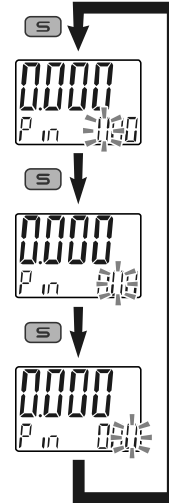



# IO-Link Specifications

## ■ Outline of IO-Link functions

### ○ Communication function

This product can check the pressure measurement value, diagnostic information and switch output status using cyclic data communication via the IO-Link system.

### ○ Product status monitoring function

This function monitors the product status via the IO-Link communication.

- Detects the error status (internal hardware error).
- Detects the warning conditions (product internal temperature error, measurement pressure error).

### ○ Data storage function

The Data storage function stores the IO-Link device parameter settings to the IO-Link master.

With the IO-Link data storage function, the IO-Link device can be replaced easily without re-setting the equipment construction or setting parameters

When the device parameters are set and downloaded to the device using the IO-Link setting tool, the parameters in the downloaded device will be activated.

After that, these parameters are uploaded to the data storage in the master by stem command (back-up communication command).

When the device is replaced with the same type of IO-Link device due to failure, the parameter settings stored in the master are downloaded automatically, device can be operated with the parameter settings of the previous device.

Device parameter setting is applicable to 3 types of back-up levels of the master setting ("Inactive", "back-up/Restore", "Restore").

"Back-up" implies the activation of upload and "restore" implies download.

## ■ Communication specifications

IO-Link type	Device
IO-Link version	V1.1
Communication speed	COM2 (38.4 kbps)
Min. cycle time	2.3 ms
Process data length	Input Data: 2 byte, Output Data: 0 byte
On request data communication	Available
Data storage function	Available
Event function	Available

## ■ Process data

Process data is the data which is exchanged periodically between the master and device.  
This product process data consists of switch output status, error diagnostics and pressure gauge measurement value.

(Refer to the table below.)

Bit offset	Item	Notes
0	OUT1 output	0: OFF 1: ON
1	OUT2 output	0: OFF 1: ON
2	Diagnosis	0: Normal 1: Abnormal Set with the index 0x03EB. *: Refer to the table (diagnostic information).
3 to 15	Pressure gauge measurement value	Unsigned 13bit *: Refer to the table (Unit specification and pressure gauge measurement value (PD)).

Bit offset	15	14	13	12	11	10	9	8	7	6	5	4	3	2	1	0
Item	Pressure gauge measurement value (PD)													Diagnosis	OUT2	OUT1

•The process data of this product is Big-Endian type.

When the transmission method of the upper communication is Little-Endian, the byte order will be changed.  
Refer to the table below for the Endian type of the major upper communication.

Endian type	Upper communication protocol
Big-Endian type	Such as PROFIBUS and PROFINET
Little-Endian type	Such as EtherNET/IP, EtherCAT and CC-Link IE Field.

## ○ Diagnostic information

This product can detect the device error by diagnostic bit in the process data.

Monitoring items of the device condition can be set by the diagnostic information selection [F\_0].

Set value	Content
ALL All errors	Diagnostic bit will be "1: ON" when either of the following errors is generated. •Product internal failure •Residual pressure error •Exceeding upper limit of the temperature in the product •Out of the rated pressure (when HHH and LLL are generated.)
PrES Pressurizing error	Diagnostic bit will be "1: ON" when the following error is generated. •Out of the rated pressure (when HHH and LLL are generated.)
oFF Unused	Diagnostic information is not used.

○Unit specification and pressure gauge measurement value (PD)

Series	Unit	Rated pressure range			Display/settable range		
ISE20C	MPa	-0.100	to	1.000	-0.105	to	1.050
	kPa	-100	to	1000	-105	to	1050
	kgf/cm <sup>2</sup>	-1.02	to	10.197	-1.07	to	10.71
	bar	-1.00	to	10.00	-1.05	to	10.50
	psi	-14.5	to	145.04	-15.2	to	152.3
	Pressure gauge measurement value (PD)	600	to	5000	580	to	5200
ZSE20C	MPa	0	to	-0.101	0.01	to	-0.105
	kPa	0	to	-101.0	10.0	to	-105.0
	kgf/cm <sup>2</sup>	0	to	-1.0299	0.102	to	-1.071
	bar	0	to	-1.010	0.100	to	-1.050
	psi	0	to	-14.649	1.45	to	-15.23
	inchHg	0	to	-29.83	3.0	to	-31.0
	mmHg	0	to	-757.6	75	to	-788
Pressure gauge measurement value (PD)	1000	to	5040	600	to	5200	
ZSE20CF	MPa	-0.1000	to	0.1000	-0.105	to	0.105
	kPa	-100.00	to	100.00	-105.0	to	105.0
	kgf/cm <sup>2</sup>	-1.0197	to	1.0197	-1.071	to	1.071
	bar	-1.0000	to	1.0000	-1.050	to	1.050
	psi	-14.504	to	14.504	-15.22	to	15.22
	inchHg	-29.53	to	29.53	-31.0	to	31.0
	mmHg	-750.1	to	750.1	-788	to	788
	Pressure gauge measurement value (PD)	1000	to	5000	900	to	5100
ISE20CH	MPa	-0.100	to	2.000	-0.105	to	2.100
	kPa	-100	to	2000	-105	to	2100
	kgf/cm <sup>2</sup>	-1.02	to	20.394	-1.07	to	21.414
	bar	-1.00	to	20.00	-1.05	to	21.00
	psi	-14.5	to	290.08	-15.2	to	304.58
	Pressure gauge measurement value (PD)	800	to	5000	790	to	5200

\*: The figure below describes the relationship between the pressure gauge measurement value (PD) and pressure value in the unit specification (MPa) of the ISE20C series.

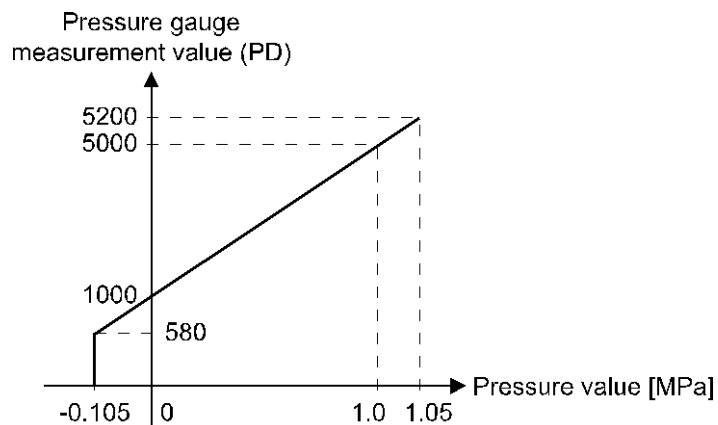

Relationship between the pressure gauge measurement value (PD) and pressure value (e.g.: ISE20C unit MPa)

○ Conversion formula of the process data and pressure gauge measurement value

**(1) Conversion formula from the process data to the pressure gauge measurement value:**

$$Pr = a \times (PD) + b$$

**(2) Conversion formula from the pressure gauge measurement value to the process data:**

$$(PD) = (Pr - b) / a$$

Pr: Pressure gauge measurement value and pressure set value

PD: Pressure gauge measurement value

a: Inclination

b: Intercept

[Inclination and intercept to the unit specification]

Series	Unit	Inclination a	Intercept b
ISE20C	MPa	0.00025	-0.25
	kPa	0.25	-250
	kgf/cm <sup>2</sup>	0.00254925	-2.54925
	bar	0.0025	-2.5
	psi	0.03626	-36.26
ZSE20C	MPa	-0.000025	0.025
	kPa	-0.025	25
	kgf/cm <sup>2</sup>	-0.000254925	0.254925
	bar	-0.00025	0.25
	psi	-0.003626	3.626
	inchHg	-0.0073825	7.3825
ZSE20CF	mmHg	-0.187525	187.525
	MPa	0.00005	-0.15
	kPa	0.05	-150
	kgf/cm <sup>2</sup>	0.00050985	-1.52955
	bar	0.0005	-1.5
	psi	0.007252	-21.756
	inchHg	0.014765	-44.295
ISE20CH	mmHg	0.37505	-1125.15
	MPa	0.0005	-0.5
	kPa	0.5	-500
	kgf/cm <sup>2</sup>	0.0050985	-5.0985
	bar	0.005	-5
	psi	0.07252	-72.52

[Calculation example]

**(1) Conversion from the process data to the pressure measurement value  
(For ISE20C series, unit specification MPa and PD = 2000)**

$$\begin{aligned} Pr &= a \times (PD) + b \\ &= 0.00025 \times 2000 - 0.25 \\ &= 0.25 \text{ [MPa]} \end{aligned}$$

**(2) Conversion from the pressure measurement value to the process data  
(For ISE20C series, unit specification MPa and Pr = 0.75 [MPa])**

$$\begin{aligned} (PD) &= (Pr - b) / a \\ &= [0.75 - (-0.25)] / 0.00025 \\ &= 4000 \end{aligned}$$

## ■IO-Link parameter setting

### ○IODD file

IODD (I/O Device Description) is a definition file which provides all properties and parameters required for establishing functions and communication of the device.

IODD includes the main IODD file and a set of image files such as vendor logo, device picture and device icon.

The IODD file is shown below.

	Product No.	IODD file *1
1	ISE20C-L(-M)-*	SMC-ISE20C-L-yyyyymmdd-IODD1.1
2	ISE20C-L-P-*	SMC-ISE20C-L-P-yyyyymmdd-IODD1.1
3	ZSE20C-L(-M)-*	SMC-ZSE20C-L-yyyyymmdd-IODD1.1
4	ZSE20C-L-P-*	SMC-ZSE20C-L-P-yyyyymmdd-IODD1.1
5	ZSE20CF-L(-M)-*	SMC-ZSE20CF-L-yyyyymmdd-IODD1.1
6	ZSE20CF-L-P-*	SMC-ZSE20CF-L-P-yyyyymmdd-IODD1.1
7	ISE20CH-L(-M)- *	SMC-ISE20CH-L-yyyyymmdd-IODD1.1
8	ISE20CH-L-P-*	SMC-ISE20CH-L-P-yyyyymmdd-IODD1.1

\*1: "yyyyymmdd" indicates the file preparation date. yyyy is the year, mm is the month and dd is the date.

The IODD file can be downloaded from the SMC Web site (<https://www.smcworld.com>).

### ○Service data

The tables below indicates the parameters which can be read or written by simple access parameter (direct parameters page) and ISDU parameters which are applicable to various parameters and commands.

\*: The parameter data of this product is the Big Endian type.

When the transmission method of the upper communication is Little-Endian, the byte order will be changed.

#### ●Direct parameters page 1

DPP1 address	Access	Parameter name	Initial value (dec)	Contents
0x07	R	Vendor ID	0x0083(131)	“SMC Corporation”
0x08				
0x09	R	Device ID	0x00022A(554)	“ISE20C-L(-M)-*”
0x0A			0x00022B(555)	“ISE20C-L-P-”
			0x00022C(556)	“ZSE20C-L(-M)-*”
			0x00022D(557)	“ZSE20C-L-P-”
0x0B	0x00022E(558)	“ZSE20CF-L(-M)-*”		
	0x00022F(559)	“ZSE20CF-L-P-”		
	0x000230(560)	“ISE20CH-L(-M)-*”		
			0x000231(561)	“ISE20CH-L-P-”

●ISDU parameters

Index (dec)	Sub index	Access *1	Parameters	Initial value	Remarks
0x0002 (2)	0	W	System command	-	Refer to "System command" on page 69.
0x000C (12)	0	R/W	Device access lock	0x0000	Refer to "Device access lock parameters" on page 70.
0x0010 (16)	0	R	Vendor name	SMC Corporation	
0x0011 (17)	0	R	Vendor text	www.smcworld.com	
0x0012 (18)	0	R	Product name	Example: ISE20C-L	
0x0013 (19)	0	R	Product ID	Example: ISE20C-L	
0x0014 (20)	0	R	Product text	Pressure sensor	
0x0015 (21)	0	R	Serial number	Example: "xxxxxxxx"	•Initial value is indicated as 8-digit. •16 octets fixed character string
0x0016 (22)	0	R	Hardware version	HW-Vx.y	x: Large revision number y: Small revision number
0x0017 (23)	0	R	Software version	FW-Vx.y	x: Large revision number y: Small revision number
0x0024 (36)	0	R	Device status parameter	-	Refer to "Device state parameters" on page 70.
0x0025 (37)	0	R	Device detailed state parameter	-	Refer to "Device detail status parameters" on page 70.
0x0028 (40)	0	R	Process data input	-	The latest value of process data can be read.

\*1: R: Read, W: Write

●System command (index 2)

In the ISDU index 0x002 SystemCommand (system command), the command shown in the table below will be issued.

The button of each system command is displayed on the IO-Link setting tool (excluding "ParamDownloadStore").

Click the button to send the system command to the product.

Writable commands are shown below.

Data type: 8 bit UInteger

Value (dec)	Function definition	Description
0x80(128)	Device Reset	Restarts the device
0x81(129)	Application Reset	Clears peak/bottom value
0x82(130)	Restore Factory Settings	Restores factory default values
0xA0(160)	Zero Clear	Executes zero clear

- Device access lock parameters (index 12)

The contents are as follows.

Data type: 16 bit Record

Value (dec)	Contents
0x0000(0)	Key lock release, DS unlock (Initial value)
0x0002(2)	Key lock release, DS lock
0x0008(8)	Key lock, DS unlock
0x000A(10)	Key lock, DS lock

**[Key lock]**

This function prevents the user from physically changing the setting of the pressure switch (button operation is not accepted).

Even when key lock function is activated, settings can be changed by IO-Link communication.

Restoration by data storage (overwriting parameter data) can be performed.

**[Lock data storage (DS lock)]**

Locking "Data storage" will invalidate the data storage function of the pressure switch.

In this case, access will be denied for backup and restoration of data storage.

- Device state parameters (index 36)

Readable device states are as follows.

Data type: 8 bit UInteger

Value (dec)	State definition	Description
0x00(0)	Normal operation	-
0x01(1)	Maintenance inspection required	Not available
0x02(2)	Outside specification range	Device temperature upper limit exceeded Measured pressure range upper limit exceeded Falls below measured pressure range lower limit
0x03(3)	Function check	Not available
0x04(4)	Failure	Internal failure of digital pressure switch

- Device detail status parameters (index 37)

Detailed event contents of readable device status are as follows.

Array	Event content	Event classification		Event code
		Definition	Value	
1	Internal failure of digital pressure switch	Error	0xF4	0x8D01
2	Internal failure of digital pressure switch	Error	0xF4	0x8D02
3	Internal failure of digital pressure switch	Error	0xF4	0x8D03
4	Internal failure of digital pressure switch	Error	0xF4	0x8D04
5	Internal failure of digital pressure switch	Error	0xF4	0x8D05
6	Internal failure of digital pressure switch	Error	0xF4	0x8D06
7	Internal failure of digital pressure switch	Error	0xF4	0x8D07
8	-	-	0x00	0x0000
9	Device temperature upper limit exceeded	warning	0xE4	0x4210
10	Measured pressure range upper limit exceeded	warning	0xE4	0x8C10
11	Fell below measured pressure range lower limit	warning	0xE4	0x8C30
12	-	-	0x00	0x0000
13	-	-	0x00	0x0000
14	Data storage upload request	notification	0x54	0xFF91

●Product individual parameters

Index (dec)	Sub index	Access *1	Parameter	Data storage *2	Date type *3	Initial value (dec)	Remarks
0x03E8 (1000)	0	R/W	Unit (Selection of display unit)	Y	U8	ISE20C-L(-M): 0 ISE20C-L-P: 4 ZSE20C-L(-M): 1 ZSE20C-L-P: 4 ZSE20CF-L(-M): 1 ZSE20CF-L-P: 4 ISE20CH-L(-M): 0 ISE20CH-L-P: 4	Setting of display unit 0: MPa 1: kPa 2: kgf/cm <sup>2</sup> 3: bar 4: psi 5: incHg (ZSE20C(F) only) 6: mmHg (ZSE20C(F) only)
0x03E9 (1001)	0	R/W	NorP (Selection of PNP/NPN)	Y	U8	0x01 (1)	Setting of switch output specification 0: NPN 1: PNP
0x03EA (1002)	0	R/W	CoL (Selection of display color)	Y	U8	0x02 (2)	Setting of display color 0: red (Constantly red) 1: Grn (Constantly green) 2: 1SoG (OUT1 turns green at ON) 3: 1Sor (OUT1 turns red at ON) 4: 2SoG (OUT2 turns green at ON) 5: 2Sor (OUT2 turns green at ON)
0x03EB (1003)	0	R/W	diAg (Selection of diagnostic information)	Y	U8	0x01 (1)	Sets the diagnostic information bit of the input process data 0: Unused (Constantly OFF) 1: All errors ON Product internal failure Residual pressure error Device temperature upper limit exceeded Measured pressure range upper limit exceeded Falls below measured pressure range lower limit 2: When the following errors occur, the parameter turns ON Measured pressure range upper limit exceeded Falls below measured pressure range lower limit
0x03F2 (1010)	0	R/W	oUt1 (Selection of OUT1 output mode)	Y	U8	0x00 (0)	Setting of OUT1 output mode 0: HYS (Hysteresis) 1: Wind (Window comparator) 2: Err (Error output) 3: oFF



•Product individual parameters (continued)

Index (dec)	Sub index	Access *1	Parameter	Data storage *2	Date type *3	Initial value (dec)	Remarks
0x03F3 (1011)	0	R/W	1ot (Selection of OUT1 normal/reversed output mode)	Y	U8	0x00 (0)	Setting of OUT1 output normal and reserved output 0: 1_P (Normal output) 1: 1_n (Reserved output)
0x03F4 (1012)	0	R/W	P_1(n_1) (Setting of OUT1 output set value)	Y	U16	ISE20C: 0x0BB8 (3000) ZSE20C: 0x0BB8 (3000) ZSE20CF: 0x0FA0 (4000) ISE20CH: 0x0BB8 (3000)	Setting of OUT1 output set value Setting range ISE20C: 0x0244 ~ 0x1450 (580 ~ 5200) ZSE20C: 0x0258 ~ 0x1450 (600 ~ 5200) ZSE20CF: 0x0384 ~ 0x13EC (900 ~ 5100) ISE20CH: 0x0316 ~ 0x1450 (790 ~ 5200)
0x03F5 (1013)	0	R/W	H_1 (Setting of OUT1 hysteresis)	Y	U16	ISE20C: 0x04B0 (1200) ZSE20C: 0x04B0 (1200) ZSE20CF: 0x0C1C (3100) ISE20CH: 0x04B0 (1200)	Setting of OUT1 hysteresis Setting range ISE20C: 0x03E8 ~ 0x15F4 (1000 ~ 5620) ZSE20C: 0x03E8 ~ 0x15E0 (1000 ~ 5600) ZSE20CF: 0x0BB8 ~ 0x1C20 (3000 ~ 7200) ISE20CH: 0x03E8 ~ 0x1522 (1000 ~ 5410)
0x03F6 (1014)	0	R/W	P1L(n1L) (Setting of OUT1 output set value _ Lower limit of window comparator)	Y	U16	ISE20C: 0x0898 (2200) ZSE20C: 0x0898 (2200) ZSE20CF: 0x0E10 (3600) ISE20CH: 0x0898 (2200)	Setting of OUT1 output set value (lower limit of window comparator) Setting range ISE20C: 0x0244 ~ 0x1450 (580 ~ 5200) ZSE20C: 0x0258 ~ 0x1450 (600 ~ 5200) ZSE20CF: 0x0384 ~ 0x13EC (900 ~ 5100) ISE20CH: 0x0316 ~ 0x1450 (790 ~ 5200)

●Product individual parameters (continued)

Index (dec)	Sub index	Access *1	Parameter	Data storage *2	Date type *3	Initial value (dec)	Remarks
0x03F7 (1015)	0	R/W	P1H(n1H) (Setting of OUT1 output set value _ Upper limit of window comparator)	Y	U16	ISE20C: 0x0D48 (3400) ZSE20C: 0x0D48 (3400) ZSE20CF: 0x1068 (4200) ISE20CH: 0x0D48 (3400)	Setting of OUT1 output set value (upper limit of window comparator) Setting range ISE20C: 0x0244 ~ 0x1450 (580 ~ 5200) ZSE20C: 0x0258 ~ 0x1450 (600 ~ 5200) ZSE20CF: 0x0384 ~ 0x13EC (900 ~ 5100) ISE20CH: 0x0316 ~ 0x1450 (790 ~ 5200)
0x03F8 (1016)	0	R/W	WH1 (Setting of OUT1 hysteresis _Window comparator hysteresis)	Y	U16	ISE20C: 0x0578 (1400) ZSE20C: 0x0578 (1400) ZSE20CF: 0x0C80 (3200) ISE20CH: 0x0578 (1400)	Setting of OUT1 hysteresis (window comparator hysteresis) Setting range ISE20C: 0x03E8 ~ 0x0CEE (1000 ~ 3310) ZSE20C: 0x03E8 ~ 0x0CE4 (1000 ~ 3300) ZSE20CF: 0x0BB8 ~ 0x13EC (3000 ~ 5100) ISE20CH: 0x03E8 ~ 0x0C85 (1000 ~ 3205)
0x03F9 (1017)	0	R/W	dtH1 (OUT1 delay time at ON)	Y	U16	0x0000 (0)	Setting of OUT1 delay time at ON Setting range 0x0000 ~ 0x1770 (0 ~ 6000) 0.01 s increment
0x03FA (1018)	0	R/W	dtL1 (OUT1 delay time at OFF)	Y	U16	0x0000 (0)	Setting of OUT1 delay time at OFF Setting range 0x0000 ~ 0x1770 (0 ~ 6000) 0.01 s increment
0x03FC (1020)	0	R/W	oUt2 (Selection of OUT2 output mode)	Y	U8	0x00 (0)	Setting of OUT2 output mode 0: HYS (Hysteresis) 1: Wind (Window comparator) 2: Err (Error output) 3: oFF
0x03FD (1021)	0	R/W	2ot (Selection of OUT2 normal/reversed output mode)	Y	U8	0x00 (0)	Setting of OUT2 normal and reversed output 0: 2_P (Normal output) 1: 2_n (Reverse output)

•Product individual parameters (continued)

Index (dec)	Sub index	Access *1	Parameter	Data storage *2	Date type *3	Initial value (dec)	Remarks
0x03FE (1022)	0	R/W	P_2(n_2) (Setting of OUT2 output set value)	Y	U16	ISE20C: 0x0BB8 (3000) ZSE20C: 0x0BB8 (3000) ZSE20CF: 0x0FA0 (4000) ISE20CH: 0x0BB8 (3000)	Setting of OUT2 output set value Setting range ISE20C: 0x0244 ~ 0x1450 (580 ~ 5200) ZSE20C: 0x0258 ~ 0x1450 (600 ~ 5200) ZSE20CF: 0x0384 ~ 0x13EC (900 ~ 5100) ISE20CH: 0x0316 ~ 0x1450 (790 ~ 5200)
0x03FF (1023)	0	R/W	H_2 (Setting of OUT2 hysteresis)	Y	U16	ISE20C: 0x04B0 (1200) ZSE20C: 0x04B0 (1200) ZSE20CF: 0x0C1C (3100) ISE20CH: 0x04B0 (1200)	Setting of OUT2 hysteresis Setting range ISE20C: 0x03E8 ~ 0x15F4 (1000 ~ 5620) ZSE20C: 0x03E8 ~ 0x15E0 (1000 ~ 5600) ZSE20CF: 0x0BB8 ~ 0x1C20 (3000 ~ 7200) ISE20CH: 0x03E8 ~ 0x1522 (1000 ~ 5410)
0x0400 (1024)	0	R/W	P2L(n2L) (Setting of OUT2 output set value_ Lower limit of window comparator)	Y	U16	ISE20C: 0x0898 (2200) ZSE20C: 0x0898 (2200) ZSE20CF: 0x0E10 (3600) ISE20CH: 0x0898 (2200)	Setting of OUT2 output set value (lower limit of window comparator) Setting range ISE20C: 0x0244 ~ 0x1450 (580 ~ 5200) ZSE20C: 0x0258 ~ 0x1450 (600 ~ 5200) ZSE20CF: 0x0384 ~ 0x13EC (900 ~ 5100) ISE20CH: 0x0316 ~ 0x1450 (790 ~ 5200)

•Product individual parameters (continued)

Index (dec)	Sub index	Access *1	Parameter	Data storage *2	Date type *3	Initial value (dec)	Remarks
0x0401 (1025)	0	R/W	P2H(n2H) (Setting of OUT2 output set value_ Upper limit of window comparator)	Y	U16	ISE20C: 0x0D48 (3400) ZSE20C: 0x0D48 (3400) ZSE20CF: 0x1068 (4200) ISE20CH: 0x0D48 (3400)	Setting of OUT2 output set value (upper limit of window comparator) Setting range ISE20C: 0x0244 ~ 0x1450 (580 ~ 5200) ZSE20C: 0x0258 ~ 0x1450 (600 ~ 5200) ZSE20CF: 0x0384 ~ 0x13EC (900 ~ 5100) ISE20CH: 0x0316 ~ 0x1450 (790 ~ 5200)
0x0402 (1026)	0	R/W	WH2 (Setting of OUT2 hysteresis_ Window comparator hysteresis)	Y	U16	ISE20C: 0x0578 (1400) ZSE20C: 0x0578 (1400) ZSE20CF: 0x0C80 (3200) ISE20CH: 0x0578 (1400)	Setting of OUT2 hysteresis (window comparator hysteresis) Setting range ISE20C: 0x03E8 ~ 0x0CEE (1000 ~ 3310) ZSE20C: 0x03E8 ~ 0x0CE4 (1000 ~ 3300) ZSE20CF: 0x0BB8 ~ 0x13EC (3000 ~ 5100) ISE20CH: 0x03E8 ~ 0x0C85 (1000 ~ 3205)

●Product individual parameters (continued)

Index (dec)	Sub index	Access *1	Parameter	Data storage *2	Date type *3	Initial value (dec)	Remarks
0x0403 (1027)	0	R/W	dtH2 (OUT2 delay time at ON)	Y	U16	0x0000 (0)	Setting of OUT2 delay time at ON Setting range 0x0000 ~ 0x1770 (0 ~ 6000) 0.01 s increment
0x0404 (1028)	0	R/W	dtL2 (OUT2 delay time at OFF)	Y	U16	0x0000 (0)	Setting of OUT2 delay time at OFF Setting range 0x0000 ~ 0x1770 (0 ~ 6000) 0.01 s increment
0x0406 (1030)	0	R/W	FiL (Digital filter)	Y	U16	0x0000 (0)	Setting of digital filter 0x0000 ~ 0x0BB8 (0 ~ 3000) 0.01 s increment
0x0424 (1060)	0	R/W	FSC (Display value fine adjustment ratio)	N	S16	0x0000 (0)	Displayed pressure value can be adjusted within ±5%R.D. (-50 ~ 50) 0.1% increments
0x044C (1100)	0	R/W	Setting of lower level screen	Y	U8	0	0: Std 1: dUAL (2 value display) 2: o1Lv (OUT1 level bar) 3: o2Lv (OUT2 level bar) 4: LinE (Line name) 5: oFF (No display)
0x044D (1101)	0	R/W	During Std setting Selection of display item	Y	U8	0	Refer to Table "selection of display items during std setting".
0x044E (1102)	0	R/W	During 2 value setting Selection of display item Left side	Y	U8	0	Refer to Table "Selection of display items during 2 value setting".
0x044F (1103)	0	R/W	During 2 value setting Selection of display item Right side	Y	U8	1	

●Product individual parameters (continued)

Index (dec)	Sub index	Access *1	Parameter	Data storage *2	Date type *3	Initial value (dec)	Remarks	
0x071C (1820)	0	R/W	Lower level screen Line name 1st letter	Y	U8	0	Refer to Figure "1st letter (11seg) of Line name communication data".	
0x071D (1821)	0	R/W		Line name 2nd letter	Y	U8	0	Refer to Figure "2nd to 4th letter (7seg) of Line name communication data".
0x071E (1822)	0	R/W		Line name 3rd letter	Y	U8	0	
0x071F (1823)	0	R/W		Line name 4th letter	Y	U8	0	
0x0720 (1824)	0	R/W		Line name Left side dot	Y	U8	0	
0x0721 (1825)	0	R/W		Line name Center dot	Y	U8	0	
0x0722 (1826)	0	R/W		Line name Right side dot	Y	U8	0	
0x0456 (1110)	0	R/W	drE (Selection of display value resolution)	Y	U8	0x00 (0)	Setting of display value resolution 0: Normal resolution 1: Lower resolution (1/10)	
0x0474 (1140)	0	R/W	Cut (Zero-cut)	Y	U8	0	Display value around 0 is displayed as 0. Setting range 0 ~ 10 1.0% increments	
0x0708 (1800)	0	R/W	EC0 (Economy mode)	Y	U8	0x00 (0)	Setting of power saving mode 0: OFF 1: on	
0x0712 (1810)	0	R/W	Pin (use or unused of the security code)	Y	U8	0x00 (0)	Setting of use or unused of the security code 0: Unused 1: Used	
0x0713 (1811)	0	R/W	PinCode (Security code)	Y	U16	0x0000 (0)	Setting of security code 0 ~ 999	
0x07D0 (2000)	0	R	Measurement related Process data Conversion formula Inclination a	N	F32		Refer to table "Inclination and intercept to the unit specification". (Page 67)	
0x07D1 (2001)	0	R		Process data Conversion formula Intercept b	N	F32		
0x07D2 (2002)	0	R		Peak value	N	U16	0	Refer to process data on page 65 to 67.
0x07D3 (2003)	0	R		Bottom value	N	U16	0	

●Product individual parameters (continued)

Index (dec)	Sub index	Access *1	Parameter	Data storage *2	Date type *3	Initial value (dec)	Remarks
0x07D4 (2004)	0	R	Diagnostic information Number of pressurizing errors	N	U16	0	0 ~ 1000

\*1: "R" means Read and "W" means Write.

\*2: "Y" indicates that the parameter setting data is saved to the master, and "N" indicates that the parameter is not saved.

\*3: Refer to the table below for the symbol.

Symbol	Data type (IO-Link standard)	Data length Bit [byte]	Description
U8	UIntegerT	8[1]	Unsigned integer
U16		16[2]	
S16	IntegerT	16[2]	Signed integer
F32	Float32T	32[4]	Floating point number

[Selection of display items during standard setting]

Value	Setting content		Supplemental information
0	OUT1	HYS mode set value	When the value which does not match the OUT* output mode setting is written, acknowledgment is sent and [Std - -] is displayed.
1		HYS mode hysteresis	
2		Wind mode lower side set value	
3		Wind mode upper side set value	
4		Wind mode hysteresis	
5		Err mode	
6		oFF mode	
7	OUT2	HYS mode set value	
8		HYS mode hysteresis	
9		Wind mode lower side set value	
10		Wind mode upper side set value	
11		Wind mode hysteresis	
12		Err mode	
13		oFF mode	
14	Pressure bottom value		
15	Pressure peak value		
16	Reservation		
17	SW output mode/communication mode display		

[Selection of display items during 2 value setting]

Value	Setting content		Selection of display items during 2 value setting		Supplemental information
			Left side	Right side	
0	OUT1	HYS mode set value	●	●	When the value which does not match the OUT* output mode setting is written, acknowledgment is sent and [- -] is displayed.
1		HYS mode hysteresis	●	●	
2		Wind mode lower side set value	●	●	
3		Wind mode upper side set value	●	●	
4		Wind mode hysteresis	●	●	
5	OUT2	HYS mode set value	●	●	
6		HYS mode hysteresis	●	●	
7		Wind mode lower side set value	●	●	
8		Wind mode upper side set value	●	●	
9		Wind mode hysteresis	●	●	
10	Pressure peak value		●	×	
11	Pressure bottom value		×	●	
12	Reservation		×	×	
13	Pressure display unit		●	●	
14	Range specification		●	●	
15	OUT1 output mode/output style		●	×	
16	OUT2 output mode/output style		×	●	
17	NPN/PNP output		●	●	
18	Line name		●	●	
19	Display OFF (No display)		●	●	

●: Settable                      x: Not settable (negative acknowledge)



Default ↙

16 Hex number	00	01	02	03	04	05	06	07	08	09	0A	0B	0C	0D	0E	0F
Display letter	0	1	2	3	4	5	6	7	8	9	A	B	C	D	E	F
16 Hex number	10	11	12	13	14	15	16	17	18	19	1A	1B	1C	1D	1E	1F
Display letter	0	1	5	6	0	0	W	H	9	7	0	0	2	3	4	5
16 Hex number	20	21	22	23	24	25	26	27	28	29	2A	2B	2C	2D	2E	2F
Display letter	5	0	8	9	2	2	2	2	H	9	2	H	2	H	4	0

Line name: Communication data 1st letter (11 seg)

Default ↙

16 Hex number	00	01	02	03	04	05	06	07	08	09	0A	0B	0C	0D	0E	0F
Display letter	0	1	2	3	4	5	6	7	8	9	A	B	C	D	E	F
16 Hex number	10	11	12	13	14	15	16	17	18	19	1A	1B	1C	1D	1E	1F
Display letter	2	2	5	6	0	0	9	9	2	0	1	2	3	4	5	
16 Hex number	20	21	22	23	24	25	26	27	28	29	2A	2B	2C	2D	2E	2F
Display letter	5	0	8	9	2	2	2	2	2	2	2	2	2	2	2	2

\*: : Do not work.

Line name: Communication data 2nd to 4th letter (7 seg)

## Maintenance

### **How to reset the product after a power cut or forcible de-energizing**

The setting of the product will be retained as it was before a power cut or de-energizing. The output condition is also basically recovered to that before a power cut or de-energizing, but may change depending on the operating environment. Therefore, check the safety of the whole installation before operating the product. If the installation is using accurate control, wait until the product has warmed up (approximately 10 to 15 minutes).

## Forgotten the security code

If you have forgotten your security code, please contact SMC directly.

# Troubleshooting

## ○ Troubleshooting

Applicable pressure switch: **ZSE20C(F)/ISE20C**

When any failure occurs with this product, the following chart can be used to identify the cause of the failure. If a cause applicable to the troubles cannot be identified and normal operation is recovered by replacement with a new product, this indicates that the product itself was faulty. Problems with the product may be due to the operating environment (installation etc). Please consult SMC.

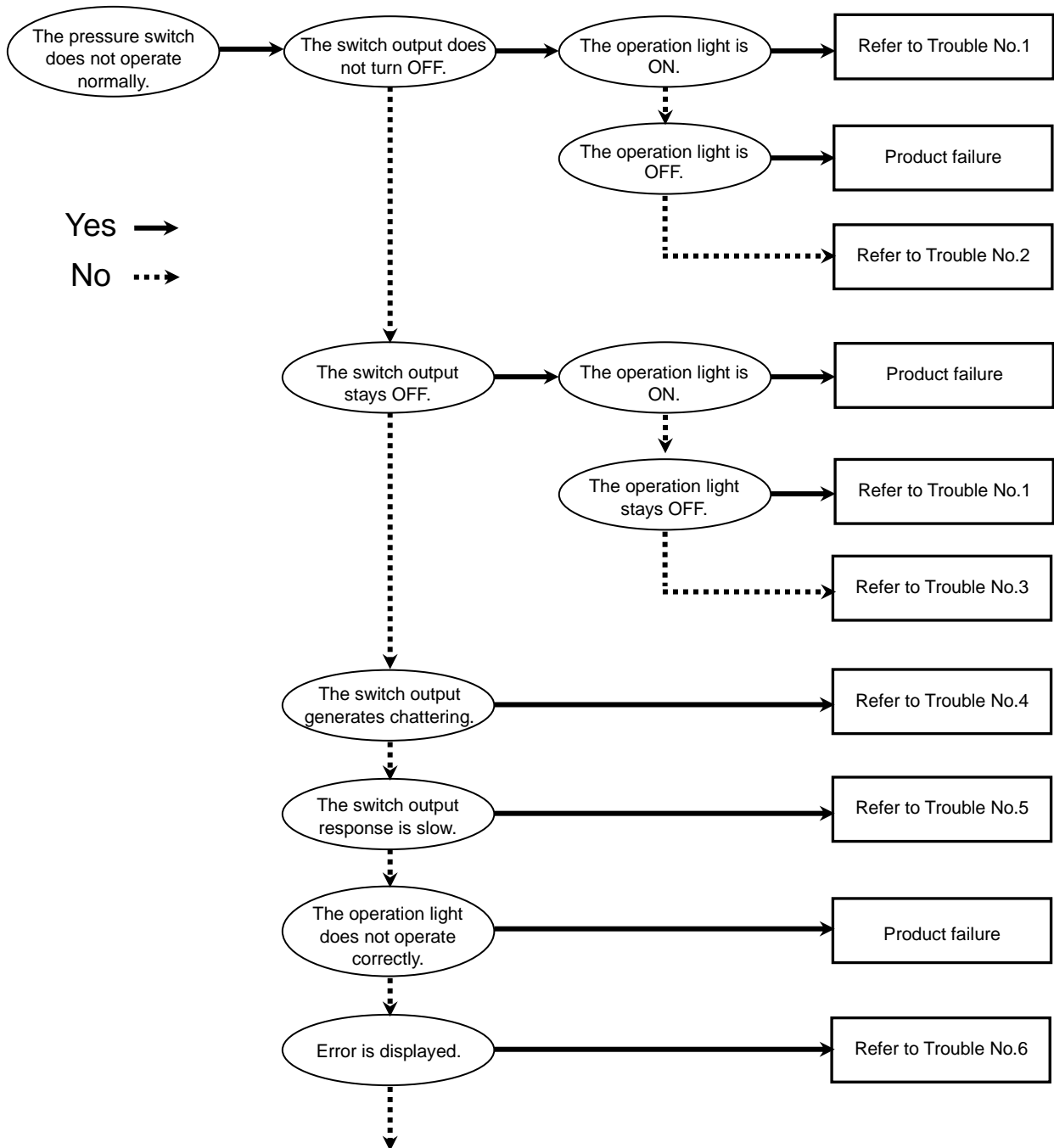

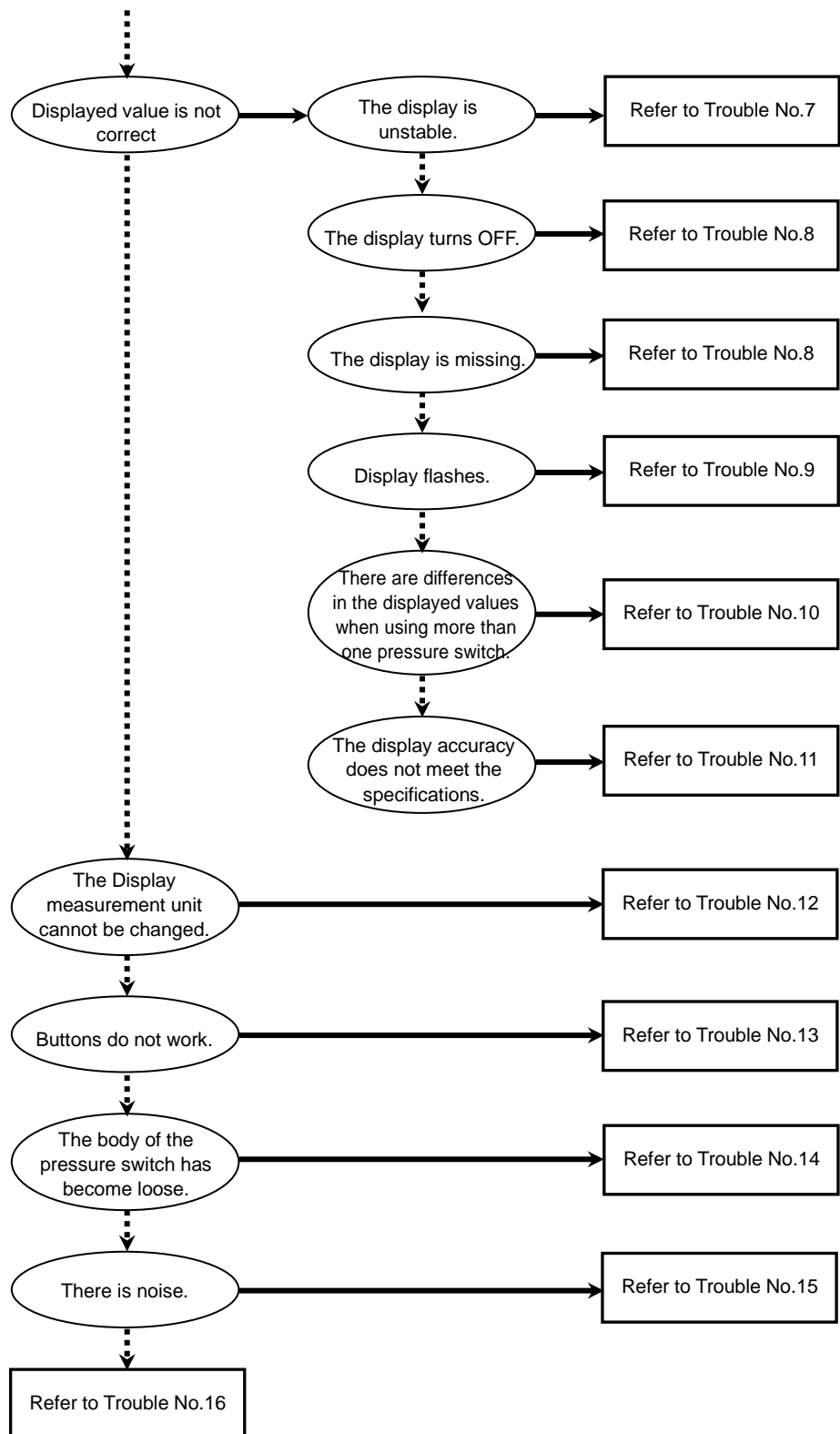

○Troubleshooting list

Problem No.	Problem	Problem possible causes	Investigation method	Countermeasures
1	<ul style="list-style-type: none"> <li>●Output remains ON. Indicator LED remains ON.</li> <li>●Output remains OFF. Indicator LED remains OFF.</li> </ul>	Incorrect pressure setting	(1) Check the set pressure. (2) Check the operation mode, hysteresis and output type. (hysteresis mode/window comparator mode, normal/reversed output)	(1) Reset the pressure setting. (2) Reset the function settings.
		Product failure		Replace the product.
2	Output remains ON. Indicator LED works correctly.	Incorrect wiring	Check the wiring of the output. Check if the load is connected directly to DC(+) or DC(-).	Correct the wiring.
		Product failure		Replace the product.
3	Output remains OFF. Indicator LED works correctly.	Incorrect wiring	Check the wiring of the output. Check if the load is connected directly to DC(+) or DC(-).	Correct the wiring.
		Unsuitable model selection	Check the SW output specification setting. Check if the SW output is PNP while NPN is intended to be set, and vice versa.	Set the SW output specification again.
		Broken lead wire	Check if there is bending stress applied to any parts of the lead wire. (bending radius and tensile force applied)	Correct the wiring conditions. (adjust the tensile force and increase the bending radius.)
		Product failure		Replace the product.
4	Switch output generates chattering.	Incorrect wiring	Check the wiring. Check if the brown and blue wires are connected to DC(+) and DC(-) respectively, and if the output wiring is loose (contact failure).	Correct the wiring.
		Incorrect settings	(1) Check the set pressure. (2) Check that the hysteresis range is not too narrow. (3) Check the delay time setting. Check if the delay time is too short.	(1) Reset the pressure setting. (2) Increase the hysteresis. (3) Reset the function settings.
		Product failure		Replace the product.
5	Slow switch output response	Incorrect pressure setting	Check the pressure setting. Check that the detected pressure and the set pressure value are not the same or not too close.	Reset the pressure setting. Set the pressure setting value so it is not too close to the detected pressure.

Problem No.	Problem	Problem possible causes	Investigation method	Countermeasures
6	<ul style="list-style-type: none"> <li>•An over current error (Er1) is displayed.</li> <li>•System error (Er0, Er4, Er6, Er7, Er8 or Er9) is displayed.</li> <li>•The display shows "HHH".</li> <li>•The display shows "LLL".</li> <li>•Residual pressure error (Er3) is displayed.</li> </ul>	Over current to the output (Er1)	<ol style="list-style-type: none"> <li>(1) Check that the switch output load current is not more than 80 mA.</li> <li>(2) Check that the connected load satisfies the specifications, and check the load for short circuits.</li> <li>(3) Check that any relay is connected with a surge voltage suppressor.</li> <li>(4) Check if the wiring is not in the same route as (or bundled together with) a high voltage cable or power cable.</li> </ol>	<ol style="list-style-type: none"> <li>(1), (2) Connect the load as specified.</li> <li>(3) Use a relay with a surge voltage suppressor or take measures to prevent noise.</li> <li>(4) Separate the wiring route from any high voltage cable or power cable.</li> </ol>
		Incorrect operation of the internal data of the Pressure switch (Er0, Er4, Er6, Er7, Er8, Er9)	<ol style="list-style-type: none"> <li>(1) Check that there is no noise interference such as static electricity, and check for noise sources.</li> <li>(2) Check that the power supply voltage is within the range 12 to 24 VDC <math>\pm 10\%</math>.</li> </ol>	<ol style="list-style-type: none"> <li>(1) Remove the noise and the noise source (or take measures to prevent noise interference), and reset the product or turn off the power supply. Then, supply the power again.</li> <li>(2) Supply a correct voltage of 12 to 24 VDC <math>\pm 10\%</math>.</li> </ol>
		Applied pressure is above the upper limit (HHH)	<ol style="list-style-type: none"> <li>(1) Check that the pressure is not above the upper limit of the set pressure range.</li> <li>(2) Check that foreign matter has not entered the piping.</li> </ol>	<ol style="list-style-type: none"> <li>(1) Adjust the pressure to within the set pressure range.</li> <li>(2) Take measures to prevent foreign matter from entering the piping.</li> </ol>
		Applied pressure is below the lower limit (LLL)	<ol style="list-style-type: none"> <li>(1) Check that the pressure is not below the lower limit of the set pressure range.</li> <li>(2) Check that foreign matter has not entered the piping.</li> </ol>	<ol style="list-style-type: none"> <li>(1) Adjust the pressure to within the set pressure range.</li> <li>(2) Take measures to prevent foreign matter from entering the piping.</li> </ol>
		Pressure is not atmospheric pressure at zero-clear operation (Er3)	Check that during the zero clear operation, pressure above $\pm 7\%$ F.S. ( $\pm 3.5\%$ F.S. for compound pressure) was not applied.	Return the applied pressure to atmospheric pressure, and retry the zero clear operation.
		Product failure		Replace the product.

Problem No.	Problem	Problem possible causes	Investigation method	Countermeasures
7	Displayed value fluctuates.	Incorrect power supply	Check that the power supply voltage is within the range 12 to 24 VDC $\pm 10\%$ .	Supply the correct voltage of 12 to 24 VDC $\pm 10\%$ .
		Incorrect wiring	Check the wiring to the power supply. Check that the brown and blue wires are connected to DC(+) and DC(-) respectively and that the output wiring is not loose (contact failure).	Correct the wiring.
		Factory pressure change	Check if the factory pressure has changed.	If the fluctuation is not acceptable, the product display resolution can be changed. Digital filter setting also needs to be improved.
8	<ul style="list-style-type: none"> <li>•Display turns OFF.</li> <li>•Part of the display is missing.</li> </ul>	Incorrect power supply	Check that the power supply voltage is within the range 12 to 24 VDC $\pm 10\%$ .	Supply the correct voltage of 12 to 24 VDC $\pm 10\%$ .
		Incorrect wiring	Check the power supply wiring. Check that the brown and blue wires are connected to DC(+) and DC(-) respectively and that the output wiring is not loose (contact failure).	Correct the wiring.
		Power saving mode	Check if the power saving mode is selected.	Reset the function settings.
		Product failure		Replace the product.
9	Display is flashing.	Wiring failure	(1) Check the power supply wiring. (2) Check if there is bending stress applied to any parts of the lead wire.	(1) Correct the wiring (2) Correct the wiring conditions (reduce the tensile force and increase the bending radius).
10	Pressure display difference when using 2 or more Pressure switches.	Dispersion within the display accuracy range	Check if the dispersion is within the display accuracy range.	Use the fine adjustment mode to adjust the display if the dispersion is within the display accuracy range.
		Product failure		Replace the product.

Problem No.	Problem	Problem possible causes	Investigation method	Countermeasures
11	The pressure display accuracy does not satisfy the specifications.	Foreign matter	Check if any foreign matter has entered the piping port.	Install a 5 μm filter to prevent foreign matter from entering the piping port. Also, clean the filter regularly to prevent drainage deposits.
		Air or fluid leakage	Check if air or fluid are leaking from the piping.	Rework the piping. If an excessive tightening torque is applied, the mounting bracket, screws or the product may be damaged.
		Insufficient warm-up time	Check if the product satisfies the specified accuracy after 10 minutes warm up time.	After energizing, the display and output can drift. For detecting fine pressures, warm up the product for 10 to 15 minutes.
		Product failure		Replace the product.
12	The display units cannot be changed.	Improper model selection (selection of model "without units selection function")	Check that the product No. printed on the product is equipped with unit switching function.	Unit selection function is not available for models which are fixed to SI units. (kPa↔MPa can be selected) *: The units selection function is not available in Japan due to a new measurement law. *: It is fixed to the SI unit "kPa", "MPa".
		Product failure		Replace the product.
13	The buttons cannot be operated.	Key lock mode	Check if the key lock mode is turned on.	Turn off the key lock mode.
		Product failure		Replace the product.
14	The product is loose.	Incorrect installation	Check that the panel mount adapter and the product are correctly assembled.	Mount the product on the panel correctly.
		Product failure		Replace the product.
15	The product is noisy.	Air or fluid leakage	Check if air or fluid are leaking from the piping.	Rework the piping. If an excessive tightening torque is applied, the mounting bracket, screws or the product may be damaged.
		Product failure		Replace the product.



Problem No.	Problem	Problem possible causes	Investigation method	Countermeasures
16	The operation is unstable. (chattering)	Effect of line pressure fluctuation because hysteresis is too narrow or delay time of the switch is too short	(1) Check the set pressure values (hysteresis) (2) Check the delay time.	(1) Check the pressure setting. (2) Reset the function settings.
		Incorrect wiring or broken lead wire	(1) Check the power supply wiring. (2) Check if there is bending stress applied to any parts of the lead wire.	(1) Correct the wiring (2) Correct the wiring conditions (reduce the tensile force and increase the bending radius).
		Product failure		Replace the product.

○Troubleshooting (IO-Link communication function)

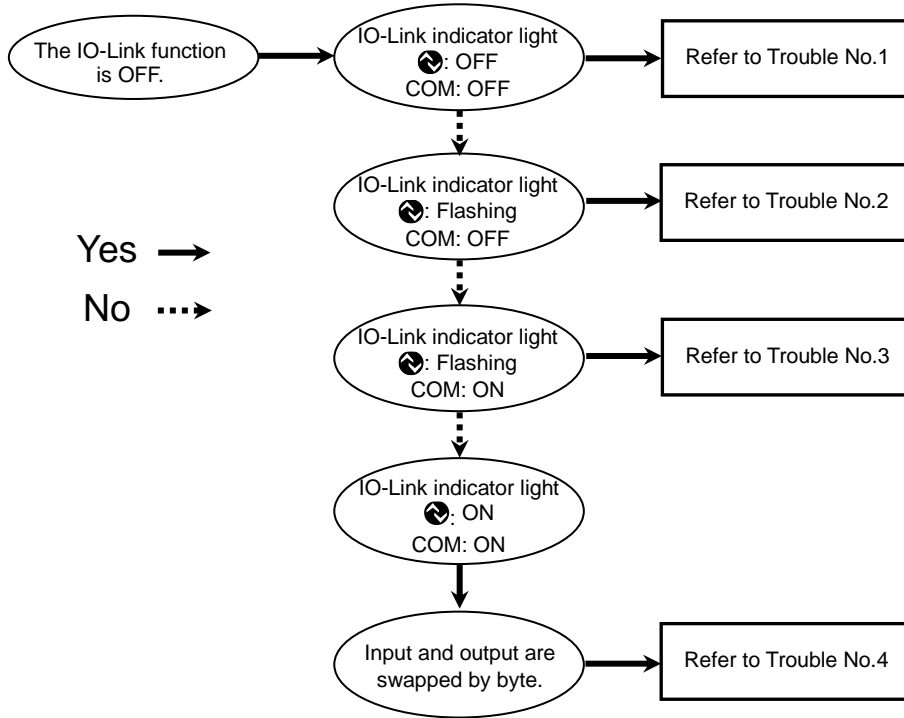







○ Troubleshooting list (IO-Link communication)

Problem No.	Problem	Description	Problem possible causes	Investigation method	Countermeasures
1	IO-Link indicator light ●: OFF COM: OFF	—	incorrect wiring	Check the connection of the connector.	Correct the cable wiring.
			Power supply error from the IO-Link master	Check the power supply voltage from the IO-Link master.	Supply 18 to 30 VDC to the IO-Link master.
2	IO-Link indicator light ●: Flashing COM: OFF	MODE ***	Communication is not established. IO-Link wiring failure	Check the connection and cable condition of the IO-Link cable.	Additionally tighten the IO-Link cable. (Replace the cable if it is broken.)
3	IO-Link indicator light ●: Flashing COM: ON	Er 15 V1.0	IO-Link master and product version are not matched.	Check the IO-Link version of the master and device.	Align the master IO-Link version to the device. *1
		MODE StcL	Communication mode is not transferred to the Operation mode.	Check the setting of the data storage access lock and data storage backup level of the master.	Release the data storage access lock. Or deactivate the setting of the data storage backup level of the master port.
		MODE LdL	Backup and restore required during data storage lock	Check the data storage lock.	Release the data storage lock.
4	Data is swapped by byte.	—	Program data assignment is incorrect.	Check that the Endian type on the master upper level communication transmission format is Big Endian type or Little Endian type.	Assign the program data based on the Endian type of the transmission format of the master upper level communication. Or set to the master byte swap setting. (Refer to page 65 for the Endian type of the upper level communication.)

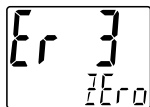
\*1: When the product is connected to the master with version "V1.0", error Er15 is generated.

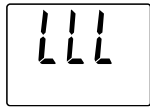
○Error indication function

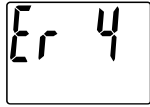
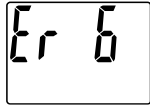
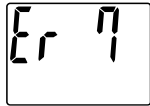
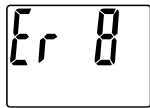
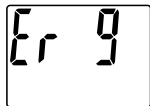
This function is to display error location and content when a problem or error has occurred.

Error	Error displayed	Description	Measures
Over current error		The load current applied to the switch output has exceeded the maximum value.	Turn the power off and remove the cause of the over current. Then supply the power again.
Residual pressure error		During zero clear operation, pressure greater than $\pm 7\%$ F.S. is present. Note that the mode is returned to measurement mode automatically 1 second later. The zero clear range varies by $\pm 1\%$ F.S. due to variation between individual products.	Release the applied pressure to atmospheric pressure, and retry the zero clear operation.
Pressurizing error		Pressure exceeding the upper limit of the set pressure range is applied.	Reset applied pressure to a level within the set pressure range.
		Pressure exceeding the lower limit of the set pressure range is applied.	
System error	     	Displayed if an internal data error has occurred.	Turn the power off and on again. If the failure cannot be solved, contact SMC.
Version does not match		Version of master and IO-Link does not match. Mismatch because master version is 1.0.	Align the master IO-Link version to the device.

If the error cannot be reset after the above measures are taken, or errors other than above are displayed, please contact SMC.

# Specification

## ■ Specifications

Product No.		ZSE20C (Vacuum pressure)	ZSE20CF (Compound pressure)	ISE20C (Positive pressure)	ISE20CH (Positive pressure)
Applicable fluid		Fluids which do not corrode SUS630, SUS304			
Pressure spec.	Rated pressure range	0.0 to -101.0 kPa	-100.0 to 100.0 kPa	-0.100 to 1.000 MPa	-0.100 to 2.000 MPa
	Display/Set pressure range	10.0 to -105.0 kPa	-105.0 to 105.0 kPa	-0.105 to 1.050 MPa	-0.105 to 2.100 MPa
	Display/Min. setting unit	0.1 kPa		0.001 MPa	
	Proof pressure	500 kPa		2 MPa	4 MPa
Power supply spec.	Power supply voltage	Used as switch output device	12 to 24 VDC ( $\pm 10\%$ ), ripple max. 10%		
		Used as IO-Link device	18 to 30 VDC, ripple max.10% (p-p)		
	Current consumption	35 mA or less			
	Protection	Polarity protection			
Accuracy	Display accuracy	$\pm 2\%$ F.S. $\pm 1$ digit (at ambient temperature $25 \pm 3$ °C)			
	Repeatability	$\pm 0.2\%$ F.S. $\pm 1$ digit			
	Analog output accuracy	$\pm 2.5\%$ F.S. (at ambient temperature $25 \pm 3$ °C)			
	Analog output linearity	$\pm 1\%$ F.S.			
	Temperature characteristics	$\pm 3\%$ F.S. ( $25$ °C standard)			
Switch output (During SIO mode)	Output type	Select from NPN or PNP open collector output			
	Output mode	Hysteresis mode, window comparator mode, error output, switch output off			
	Switch operation	Normal output, reversed output			
	Maximum load current	80 mA			
	Maximum applied voltage	30 V (during NPN output)			
	Internal voltage drop (Residual voltage)	1.5 V or less (Load current 80 mA)			
	Delay time *1	1.5 ms or less, Variable at 0 to 60 s/0.01 s step			
	Hysteresis	Hysteresis mode	Variable from 0 *2		
		Window comparator mode			
Short circuit protection		Provided			

Product No.		ZSE20C (Vacuum pressure)	ZSE20CF (Compound pressure)	ISE20C (Positive pressure)	ISE20CH (Positive pressure)
Display	Unit *3	MPa, kPa, kgf/cm <sup>2</sup> , bar, psi, InHg, mmHg		MPa, kPa, kgf/cm <sup>2</sup> , bar, psi	
	Display type	LCD			
	Number of displays	3-screen display (Main display, sub display x 2)			
	Display color	1) Main display: Red/Green 2) Sub display: Orange			
	Number of display digits	Main display: 4 digits (7-segments) Sub display: 4 digits (Upper 1 digit 11-segments, 7-segments for other)			
	Operation light	LED is ON when switch output is ON (OUT1, OUT2: Orange)			
Digital filter *4		Variable at 0 to 30 s/0.01 s step			
Environment	Enclosure	IP65			
	Withstand voltage	250 VAC for 1 minute between terminals and housing			
	Insulation resistance	2 MΩ or more between terminals and housing (with 50 VDC megger)			
	Ambient temperature range	Operation: -5 to 50 °C, Storage: -10 to 60 °C (No condensation or freezing)			
Operating humidity range		Operation, Storage: 35 to 85%RH (No condensation)			
Standard		CE/UKCA marked			
Length of lead wire with connector		2 m			

\*1: Value without digital filter (at 0 ms).

\*2: If the applied pressure fluctuates around the set value, the hysteresis must be set to a value more than the amount of fluctuation or chattering will occur.

\*3: This setting is only available for models with the units selection function. Only MPa or kPa is available for models without this function.

\*4: The response time indicates when the set value is 90% in relation to the step input.

\*5: Any products with tiny scratches, smears, or variations in the display color or brightness, which does not affect the performance of the product, are verified as conforming products.

○Piping/weight specifications

Product No.	02(L)	N02(L)	F02(L)	C01(L)	A2(L)	B2(L)	
Port size	R1/4	NPT1/4	G1/4	Rc1/8	URJ1/4	TSJ1/4	
Materials in fluid contact part	Pressure-sensing part Pressure sensor: SUS630, Fitting: SUS304						
Weight	Body (Rear piping)	51 g	51 g	48 g	47 g	54 g	46 g
	Body (Bottom piping)	77 g	78 g	74 g	65 g	81 g	72 g
	Lead wire with connector	+39 g					
Leakage	1 x 10 <sup>-5</sup> Pa • m <sup>3</sup> /s				1 x 10 <sup>-10</sup> Pa • m <sup>3</sup> /s		

○Cable specifications

Conductor area	0.15 mm <sup>2</sup> (AWG26)	
Insulator	Outside diameter	1.0 mm
	Color	Brown, Blue, Black, White, Gray (5 core)
Sheath	Finished outside diameter	φ3.5

○Communication specifications (During IO-Link mode)

IO-Link type	Device
IO-Link version	V1.1
Communication speed	COM2 (38.4 kbps)
Configuration file	IODD file *6
Min. cycle time	2.3 ms
Process data length	Input Data: 2 byte, Output Data: 0 byte
On request data communication	Available
Data storage function	Available
Event function	Available
Vendor ID	131 (0x0083)
Device ID	ISE20C-L(-M)-*: 0x00022A(554) ISE20C-L-P-*: 0x00022B(555) ZSE20C-L(-M)-*: 0x00022C(556) ZSE20C-L-P-*: 0x00022D(557) ZSE20CF-L(-M)-*: 0x00022E(558) ZSE20CF-L-P-*: 0x00022F(559) ISE20CH-L(-M)- *: 0x000230(560) ISE20CH-L-P-*: 0x000231(561)

\*6: The configuration file can be downloaded from the SMC website, <https://www.smcworld.com>

## ■ Dimensions

### 02 type

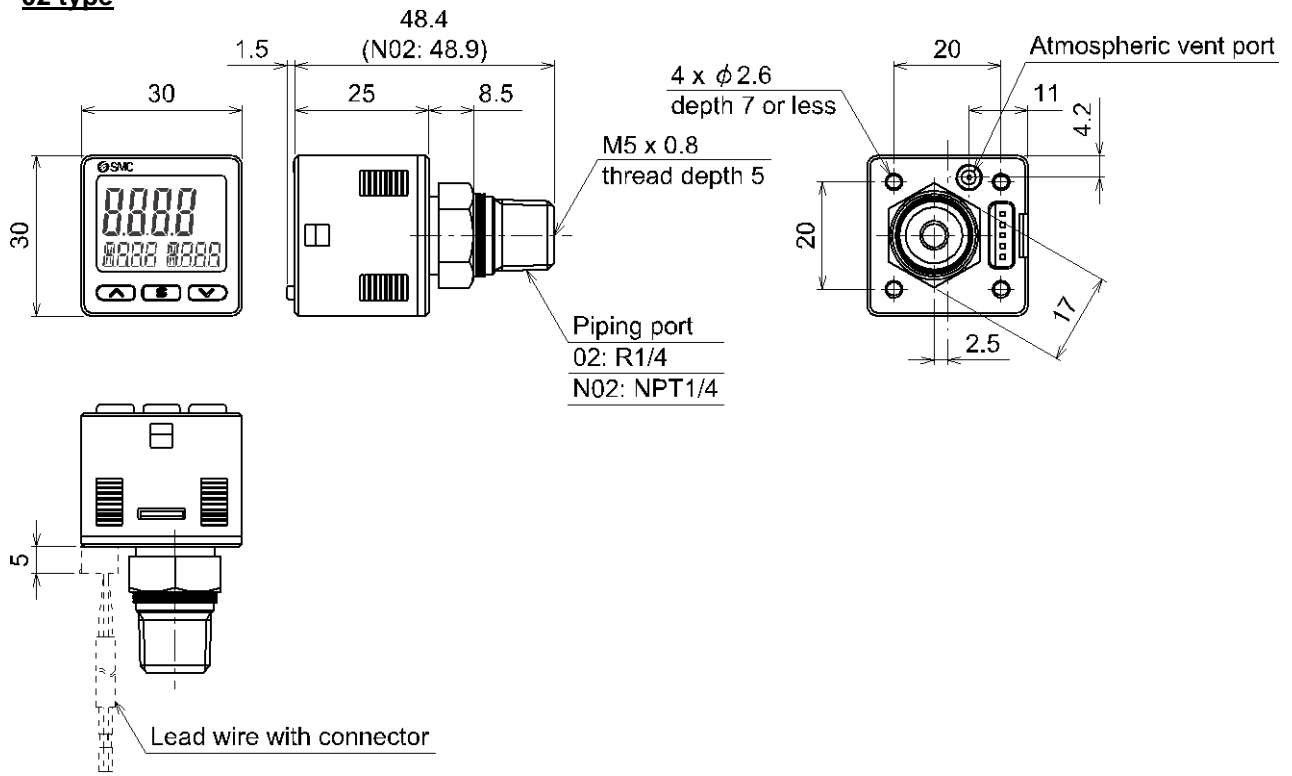



**F02 type**

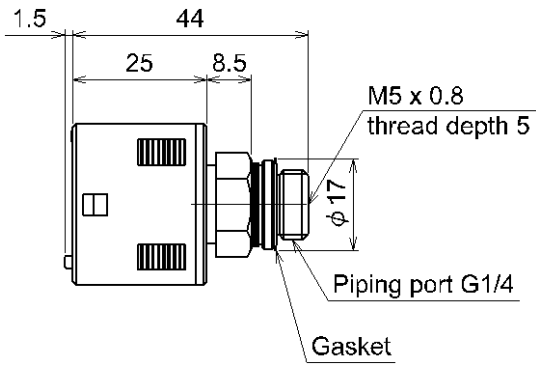

**C01 type**

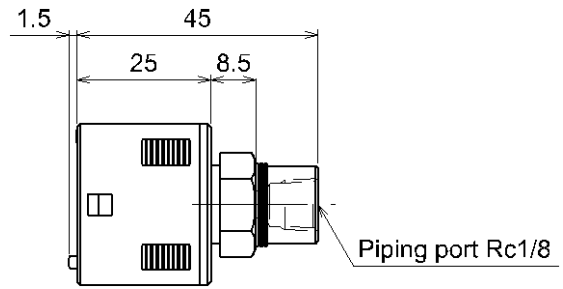

**A2 type**

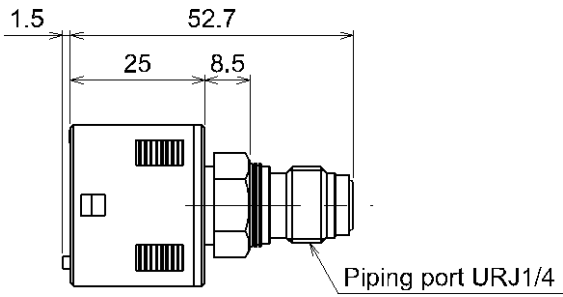

**B2 type**

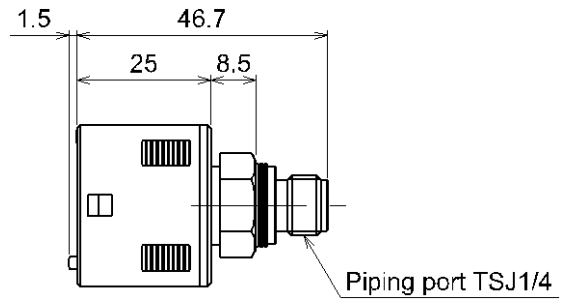

**02L type**

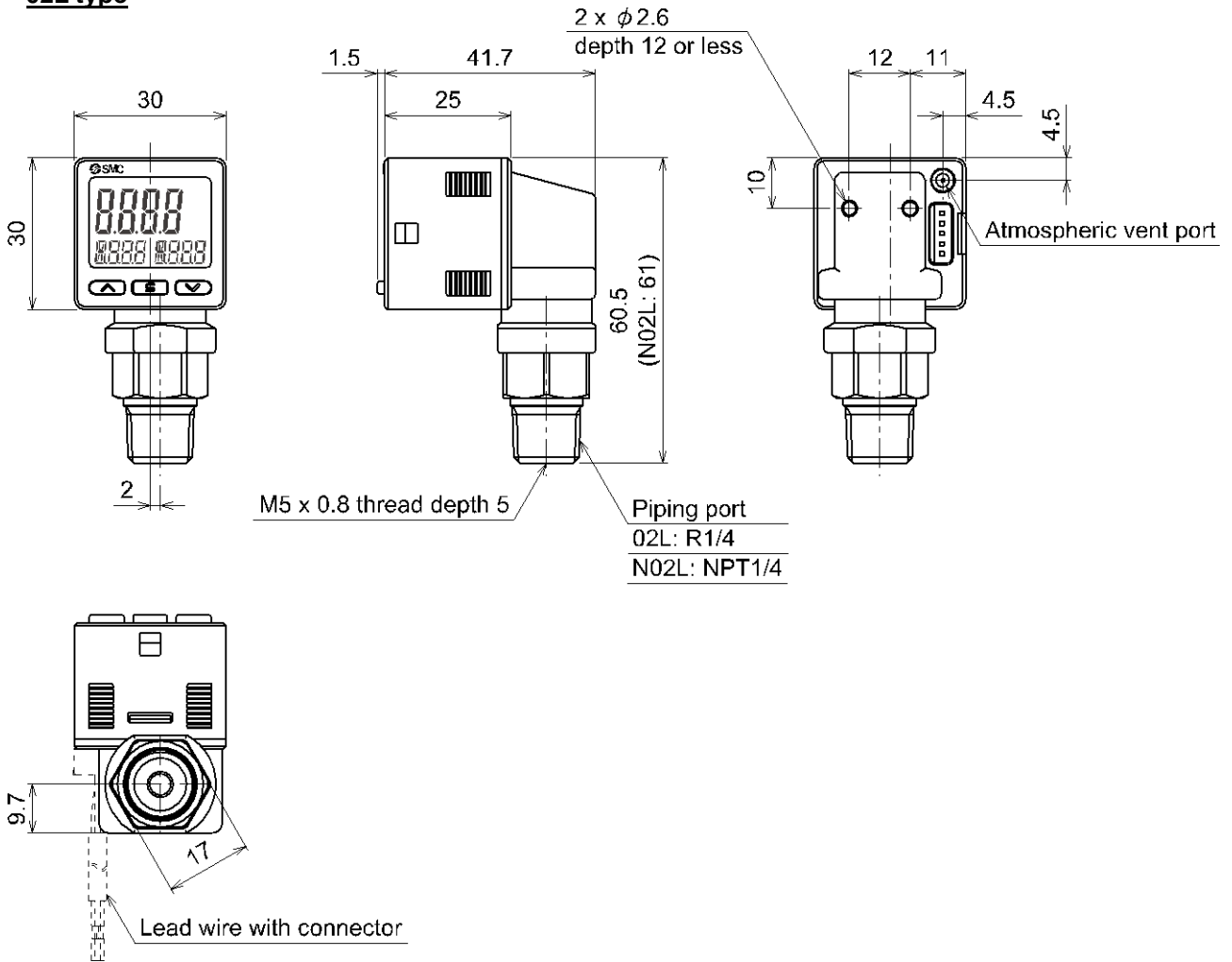

**F02L type**

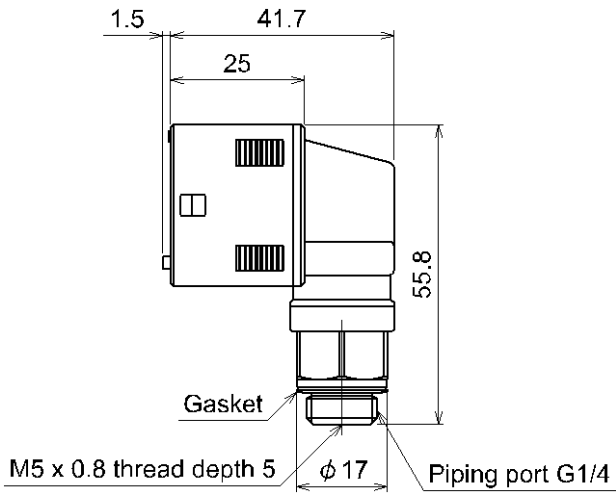

**C01L type**

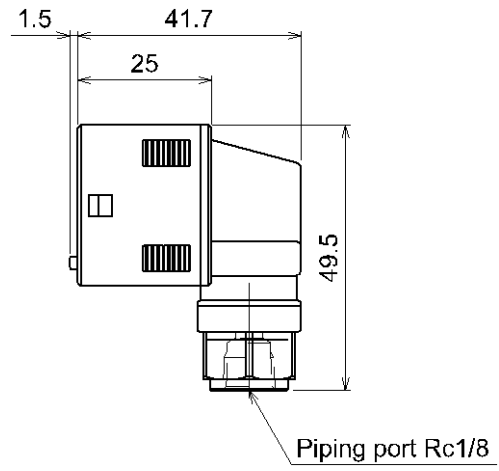

**A2L type**

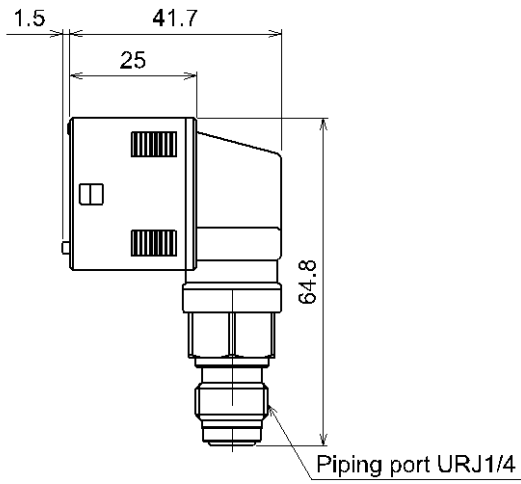

**B2L type**

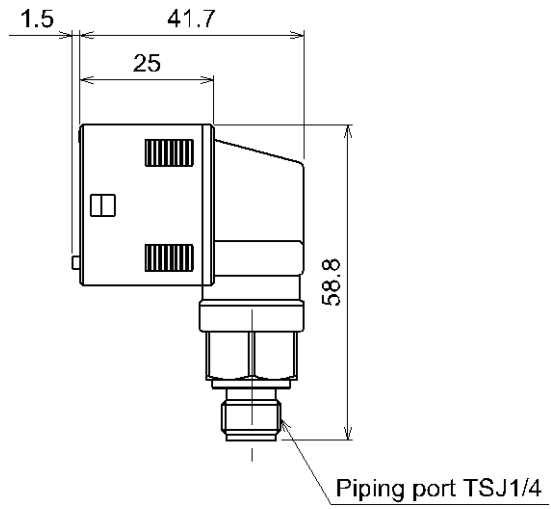

○Bracket mounting dimensions

●Bracket A

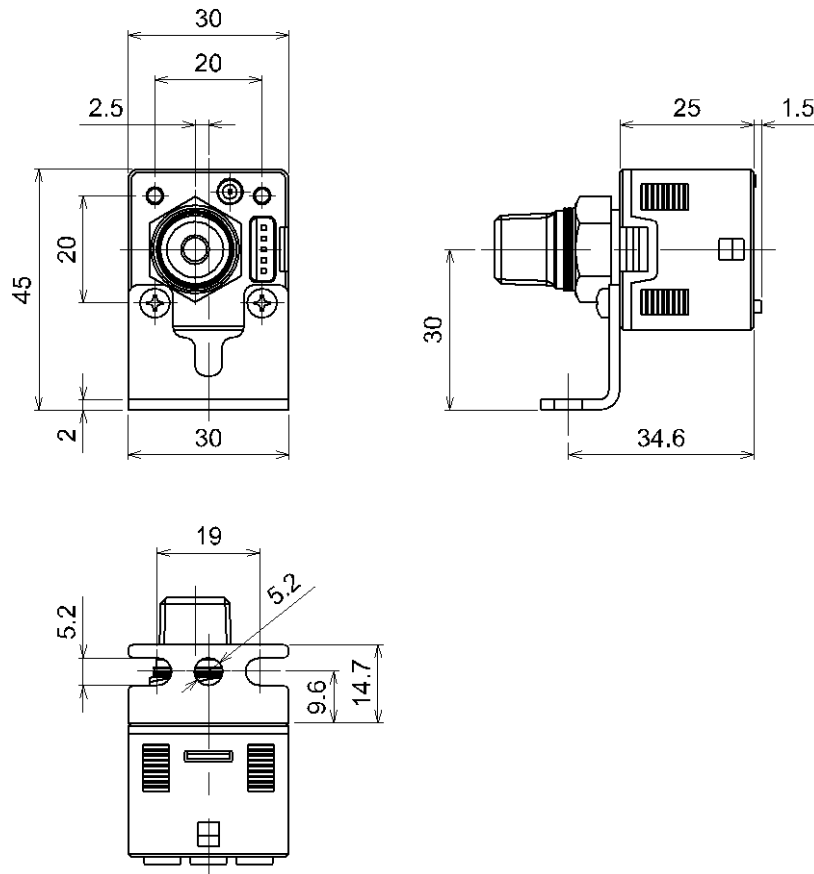

●Bracket C

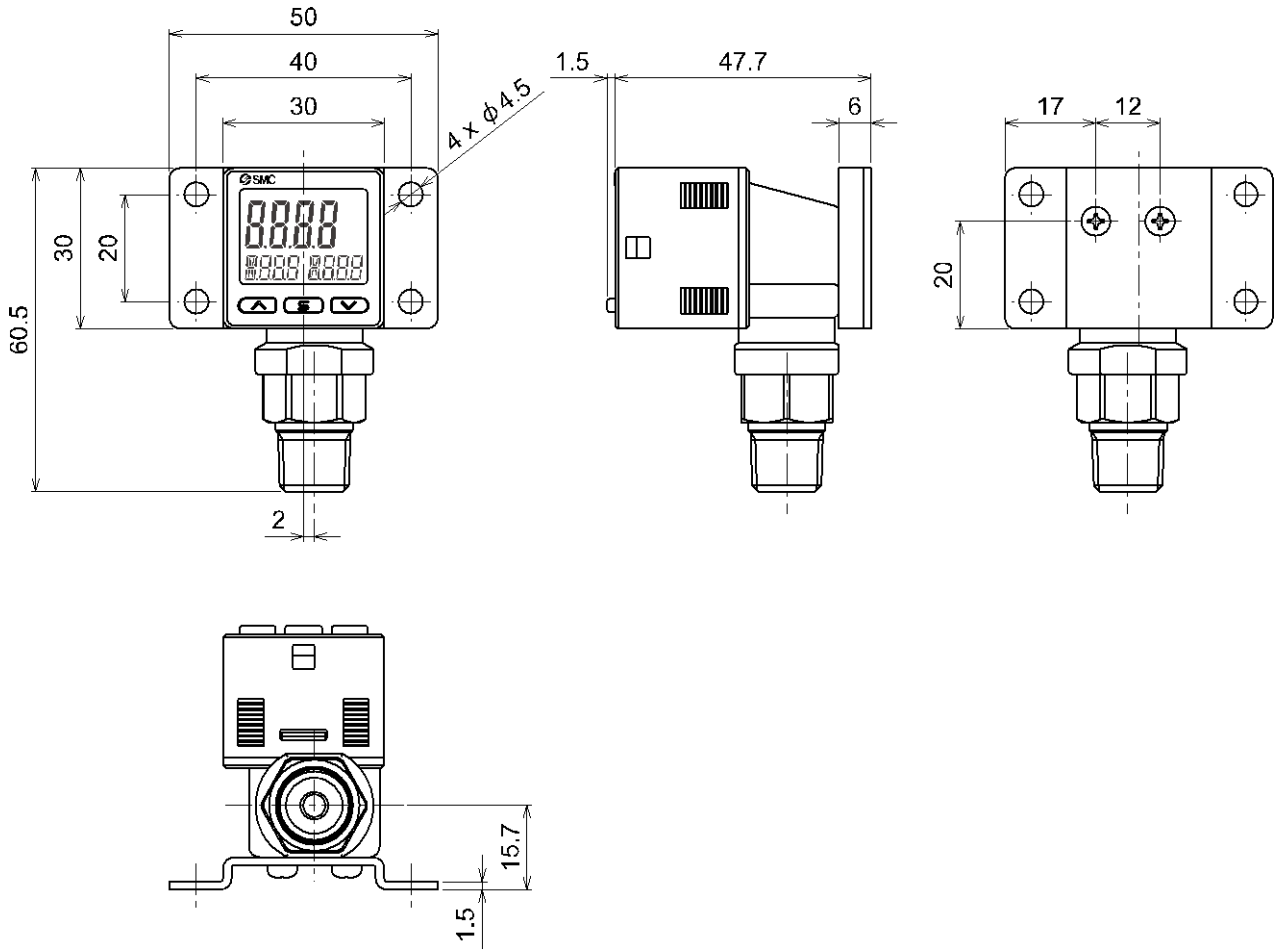

○Mounting dimensions of panel mount adapter (rear piping type)

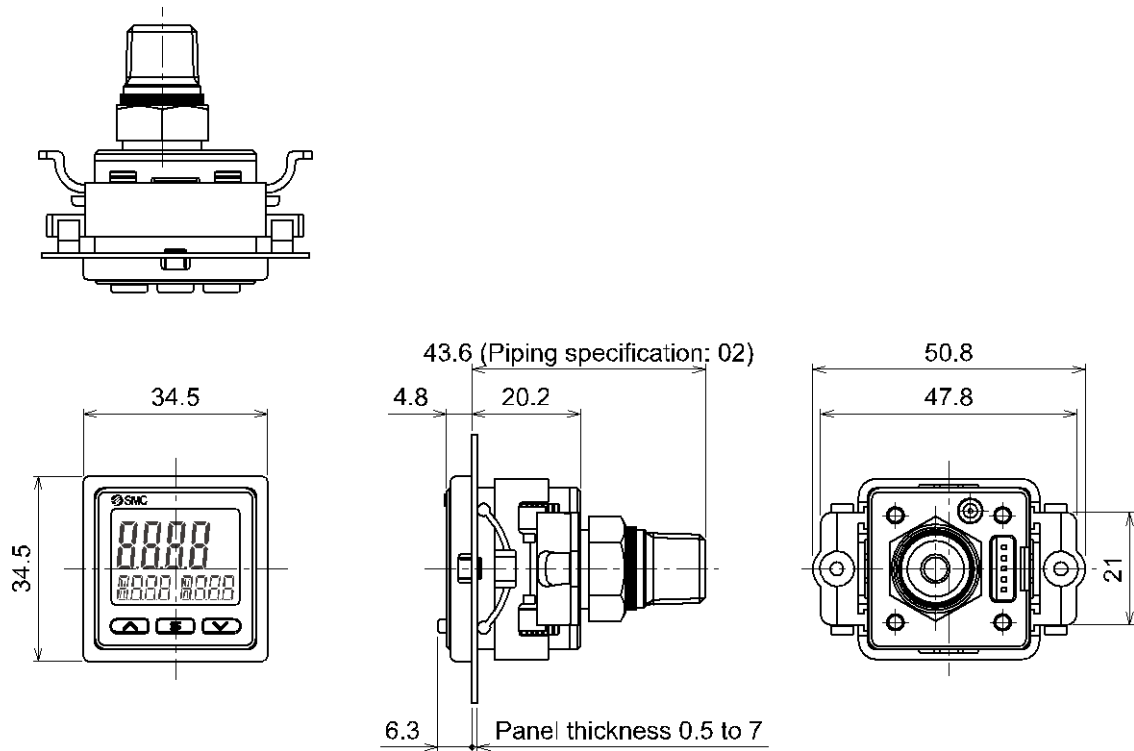

○Mounting dimension of panel mount adapter (rear piping type) + Front protective cover

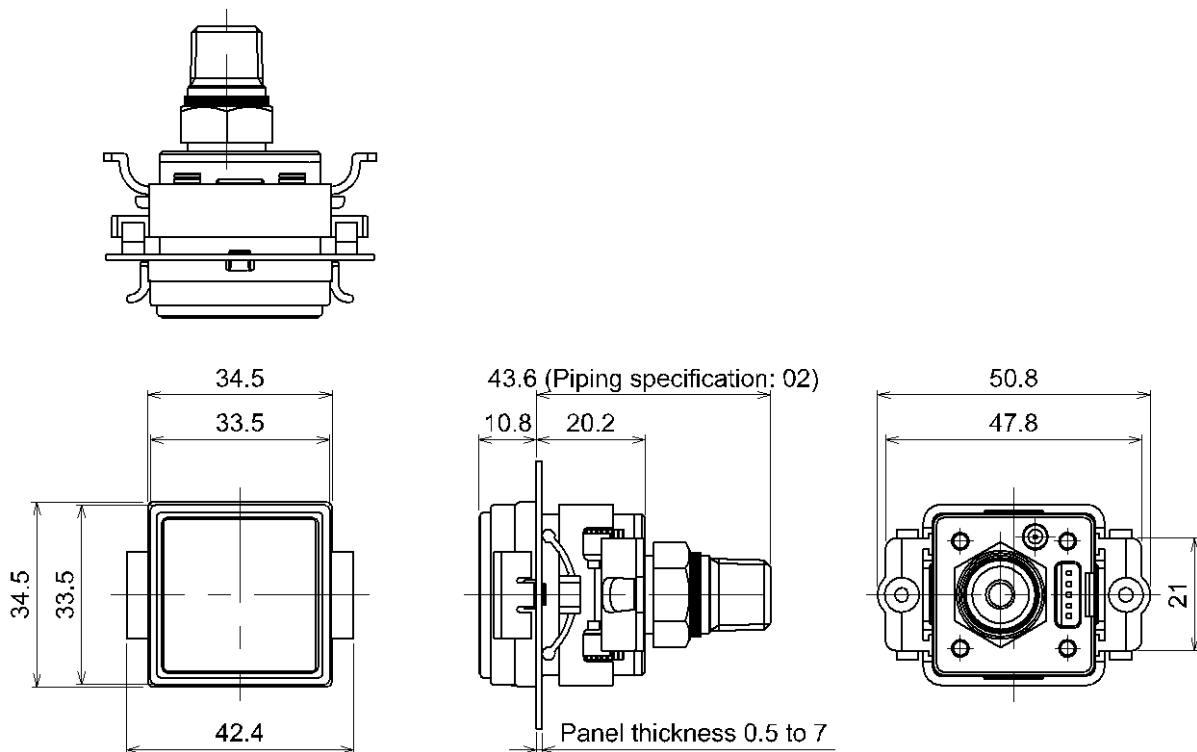

○Mounting dimensions of panel mount adapter (bottom piping type)

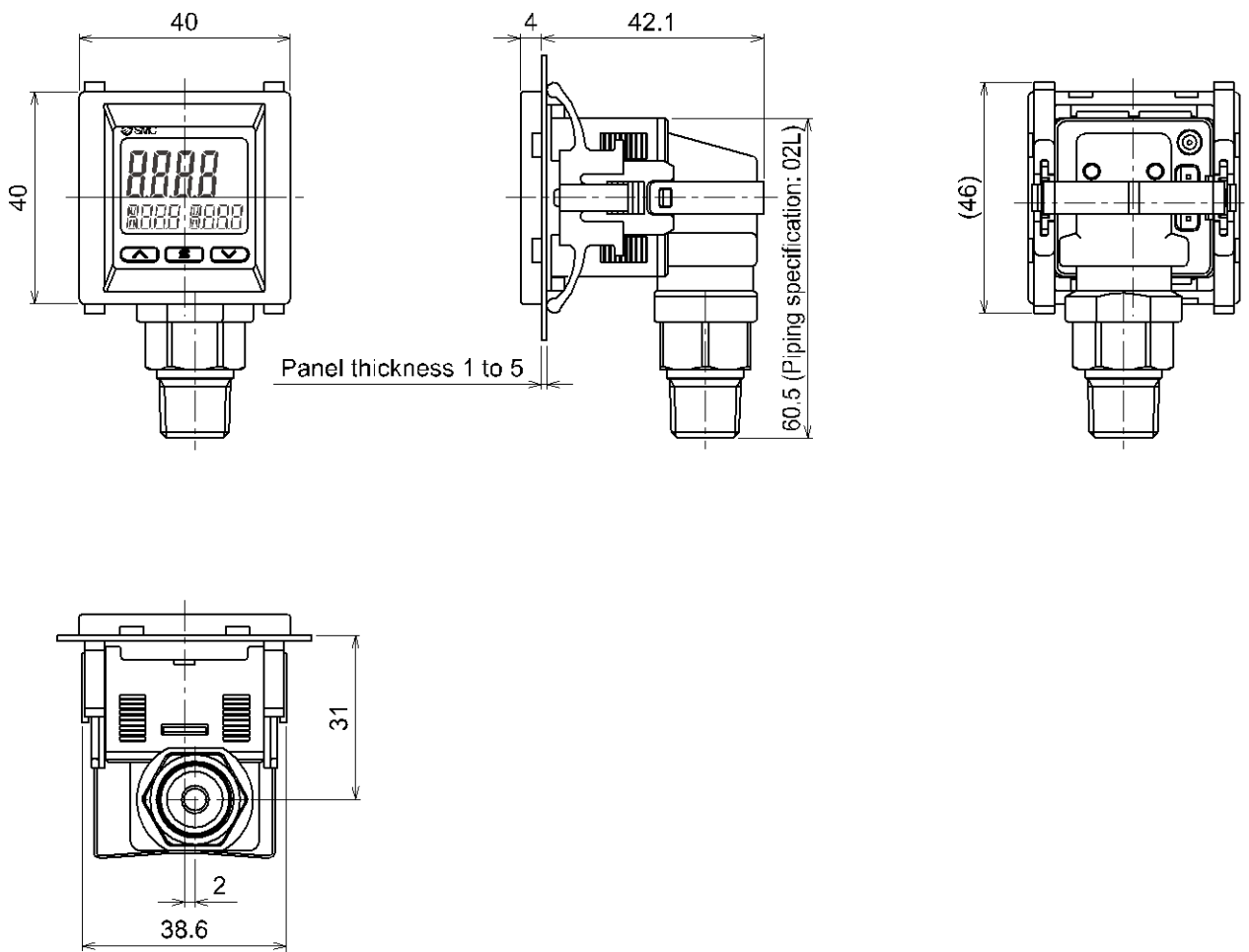

○Mounting dimension of panel mount adapter (bottom piping type) + Front protective cover

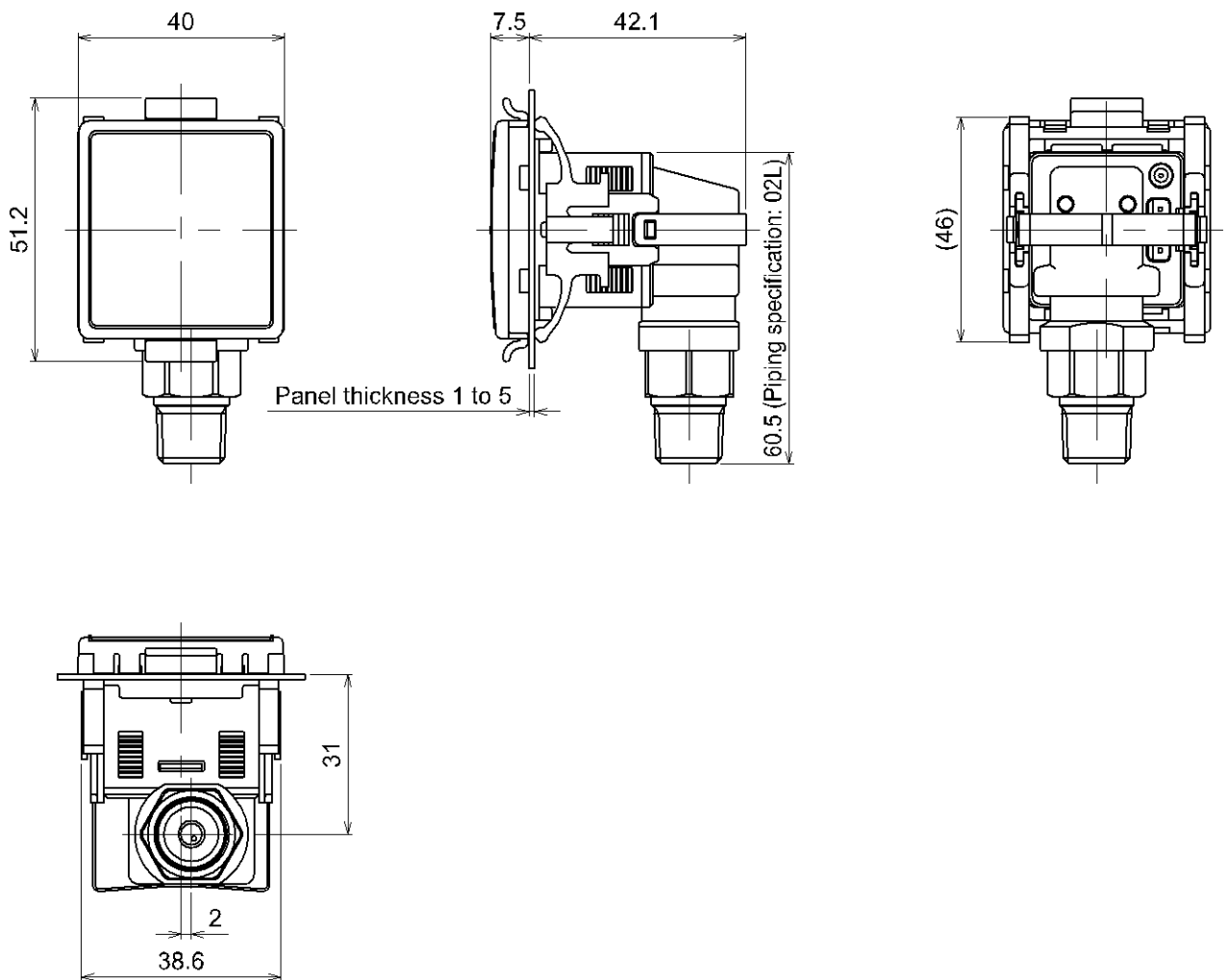



○Panel cutout dimensions (rear piping type)

Mount individually

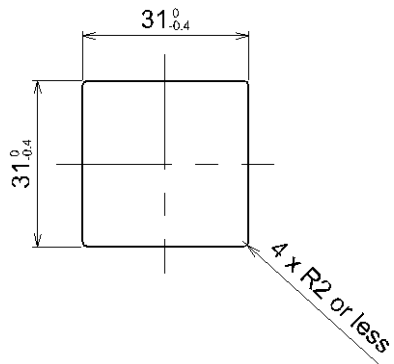

More than 2 pcs. (n pcs.) Close mounting  
<Horizontal>

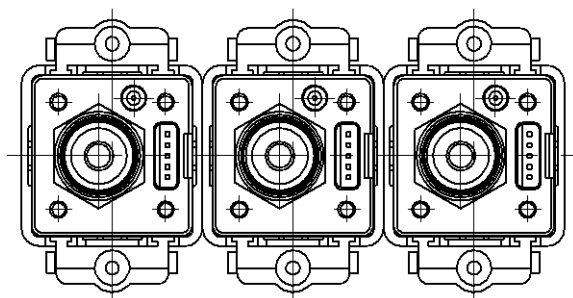
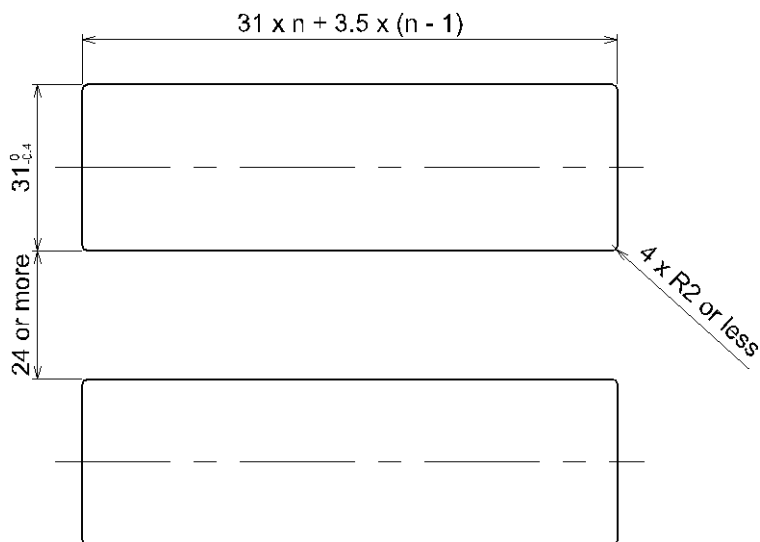

<Vertical>

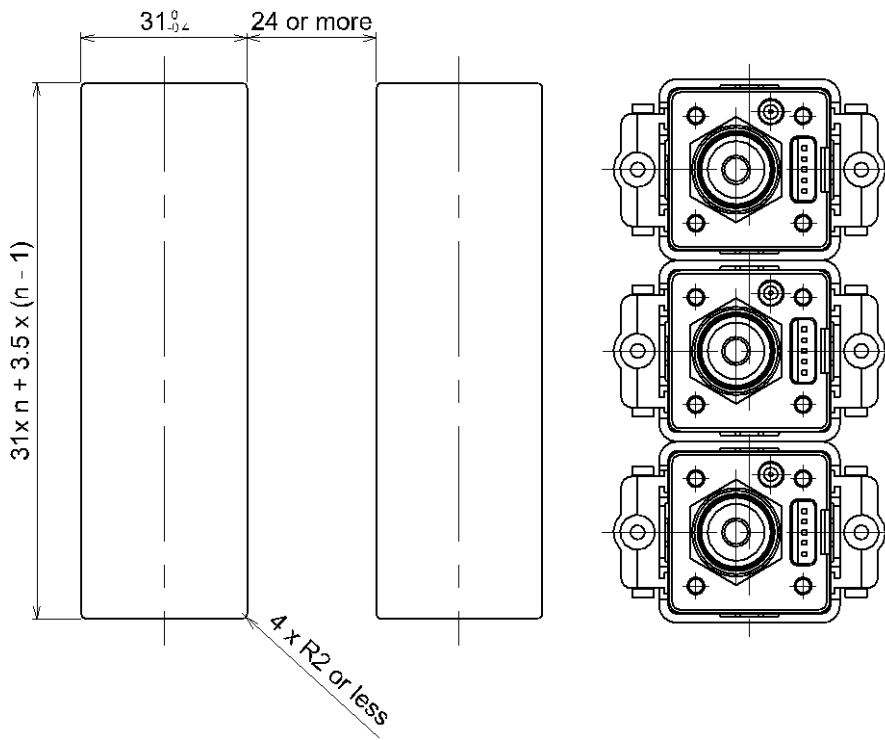

○ Panel cutout dimensions (bottom piping type)

Mount individually

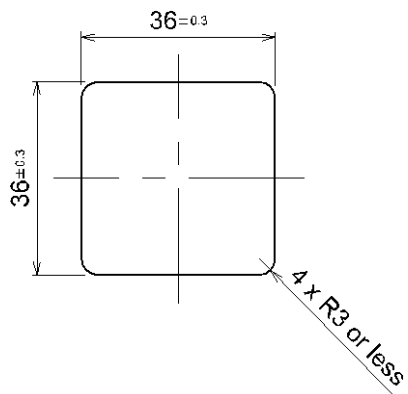

More than 2 pcs. (n pcs.) Close mounting  
<Horizontal>

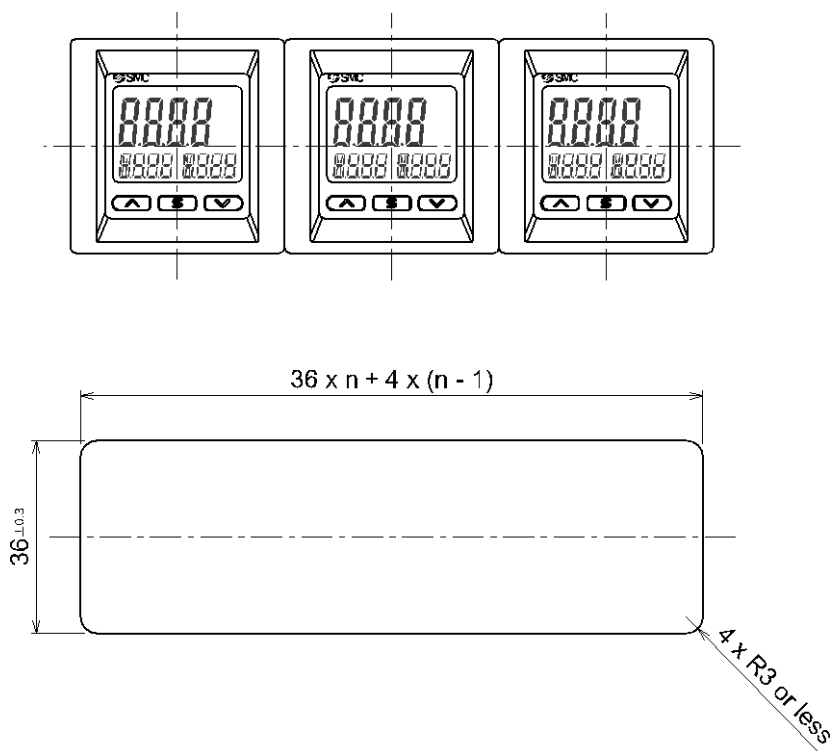

#### Revision history

A: Contents revised in several places.  
[November 2022]

## SMC Corporation

4-14-1, Sotokanda, Chiyoda-ku, Tokyo 101-0021 JAPAN

Tel: + 81 3 5207 8249 Fax: +81 3 5298 5362

URL <https://www.smcworld.com>

---

Note: Specifications are subject to change without prior notice and any obligation on the part of the manufacturer.  
© 2021-2022 SMC Corporation All Rights Reserved

