



Operation Manual

PRODUCT NAME

Electric Actuator / Guide rod Slider

MODEL / Series / Product Number

LEL Series



<Controller>
LEC Series

This manual describes the actuators operation in combination with the LECP* series controllers.
Refer to the manual relevant to the controller being used for full operating instructions.

SMC Corporation

Contents

Safety Instructions	2
1. Procedure before operation/simple setting to use straight away	4
1.1 Preparation.....	4
1.2 Controller setting software.....	5
1.3 Teaching box.....	7
2. Specification	9
2.1 Guide rod Slider LEL Series.....	9
2.2 How to Order	11
2.3 Construction	12
3. Product Outline	13
3.1 System construction	13
3.2 Setting Function	14
3.3 Step data setting method	17
3.4 Parameter setting method.....	23
4. Wiring of cables / Common precautions	26
5. Electric actuators / Common precautions	27
5.1 Design and selection	27
5.2 Mounting.....	28
5.3 Handling	29
5.4 Operating environment	30
5.5 Maintenance	31
5.6 Precautions for actuator with lock.....	31
6. Electric actuators / Guide rod Slider Common precautions	32
6.1 Design and selection	32
6.2 Handling.....	32
6.3 Mounting	33
6.4 Precaution on maintenance.....	34
7. Troubleshooting	35



LEL Series / Guide rod Slider Safety Instructions

These safety instructions are intended to prevent hazardous situations and /or equipment damage. These instructions indicate the level of potential hazard with the labels of "Caution," "Warning" or "Danger." They are all important notes for safety and must be followed in addition to International Standards (ISO /IEC), Japan Industrial Standards (JIS)*1) and other safety regulations*2).

*1) ISO 4414: Pneumatic fluid power -- General rules relating to systems
ISO 4413: Hydraulic fluid power -- General rules relating to systems
IEC 60204-1: Safety of machinery -- Electrical equipment of machines (Part 1: General requirements)
ISO 10218-1992: Manipulating industrial robots -- Safety
JIS B 8370: General rules for pneumatic equipment.
JIS B 8361: General rules for hydraulic equipment.
JIS B 9960-1: Safety of machinery – Electrical equipment for machines. (Part 1: General requirements)
JIS B 8433-1993: Manipulating industrial robots - Safety. etc.

*2) Labor Safety and Sanitation Law, etc.



Caution

Caution indicates a hazard with a low level of risk which, if not avoided, could result in minor or moderate injury.



Warning

Warning indicates a hazard with a medium level of risk which, if not avoided, could result in death or serious injury.



Danger

Danger indicates a hazard with a high level of risk which, if not avoided, will result in death or serious injury.

Warning

1. The compatibility of the product is the responsibility of the person who designs the equipment or decides its specifications.

Since the product specified here is used under various operating conditions, its compatibility with specific equipment must be decided by the person who designs the equipment or decides its specifications based on necessary analysis and test results.

The expected performance and safety assurance of the equipment will be the responsibility of the person who has determined its compatibility with the product.

This person should also continuously review all specifications of the product referring to its latest catalog information, with a view to giving due consideration to any possibility of equipment failure when configuring the equipment.

2. Only personnel with appropriate training should operate machinery and equipment.

The product specified here may become unsafe if handled incorrectly.

The assembly, operation and maintenance of machines or equipment including our products must be performed by an operator who is appropriately trained and experienced.

3. Do not service or attempt to remove product and machinery /equipment until safety is confirmed.

The inspection and maintenance of machinery /equipment should only be performed after measures to prevent falling or runaway of the driven objects have been confirmed.

When the product is to be removed, confirm that the safety measures as mentioned above are implemented and the power from any appropriate source is cut, and read and understand the specific product precautions of all relevant products carefully.

Before machinery /equipment is restarted, take measures to prevent unexpected operation and malfunction.

4. Contact SMC beforehand and take special consideration of safety measures if the product is to be used in any of the following conditions.

1) Conditions and environments outside of the given specifications, or use outdoors or in a place exposed to direct sunlight.

2) Installation on equipment in conjunction with atomic energy, railways, air navigation, space, shipping, vehicles, military, medical treatment, combustion and recreation, or equipment in contact with food and beverages, emergency stop circuits, clutch and brake circuits in press applications, safety equipment or other applications unsuitable for the standard specifications described in the product catalog.

3) An application which could have negative effects on people, property, or animals requiring special safety analysis.

4) Use in an interlock circuit, which requires the provision of double interlock for possible failure by using a mechanical protective function, and periodical checks to confirm proper operation.



LEL Series / Guide rod Slider Safety Instructions

Caution

1. The product is provided for use in manufacturing industries.

The product herein described is basically provided for peaceful use in manufacturing industries. If considering using the product in other industries, consult SMC beforehand and exchange specifications or a contract if necessary.
If anything is unclear, contact your nearest sales branch.

Limited warranty and Disclaimer/Compliance Requirements

The product used is subject to the following "Limited warranty and Disclaimer" and "Compliance Requirements".

Read and accept them before using the product.

Limited warranty and Disclaimer

1. The warranty period of the product is 1 year in service or 1.5 years after the product is delivered.*3)

Also, the product may have specified durability, running distance or replacement parts. Please consult your nearest sales branch.

2. For any failure or damage reported within the warranty period which is clearly our responsibility, a replacement product or necessary parts will be provided.

This limited warranty applies only to our product independently, and not to any other damage incurred due to the failure of the product.

3. Prior to using SMC products, please read and understand the warranty terms and disclaimers noted in the specified catalog for the particular products.

***3) Vacuum pads are excluded from this 1 year warranty.**

A vacuum pad is a consumable part, so it is warranted for a year after it is delivered. Also, even within the warranty period, the wear of a product due to the use of the vacuum pad or failure due to the deterioration of rubber material are not covered by the limited warranty.

Compliance Requirements

1. The use of SMC products with production equipment for the manufacture of weapons of mass destruction (WMD) or any other weapon is strictly prohibited.

2. The exports of SMC products or technology from one country to another are governed by the relevant security laws and regulation of the countries involved in the transaction. Prior to the shipment of a SMC product to another country, assure that all local rules governing that export are known and followed.

1. Procedure before operation/simple setting to use straight away

The controller is shipped with the parameters appropriate to the actuator.

With the simple setting “easy mode”, it can be operated and running parameters can be changed easily.

1.1 Preparation

(1) Items to be prepared

Please check on the label, and the quantity of accessories, to confirm that it is the product that was ordered.

Table 1. Components

No.	Part name	Qty
(1)	Electric actuator / Guide rod Slider	1
(2)	Controller	1
(3)	Power supply plug	1
(4)	Actuator cable	1
(5)	I/O cable (Not use in this section)	1
(6)	Teaching box	1
(7)	Controller setting kit	1
[The controller setting software, The communication cable, USB cable and conversion unit are included.]		

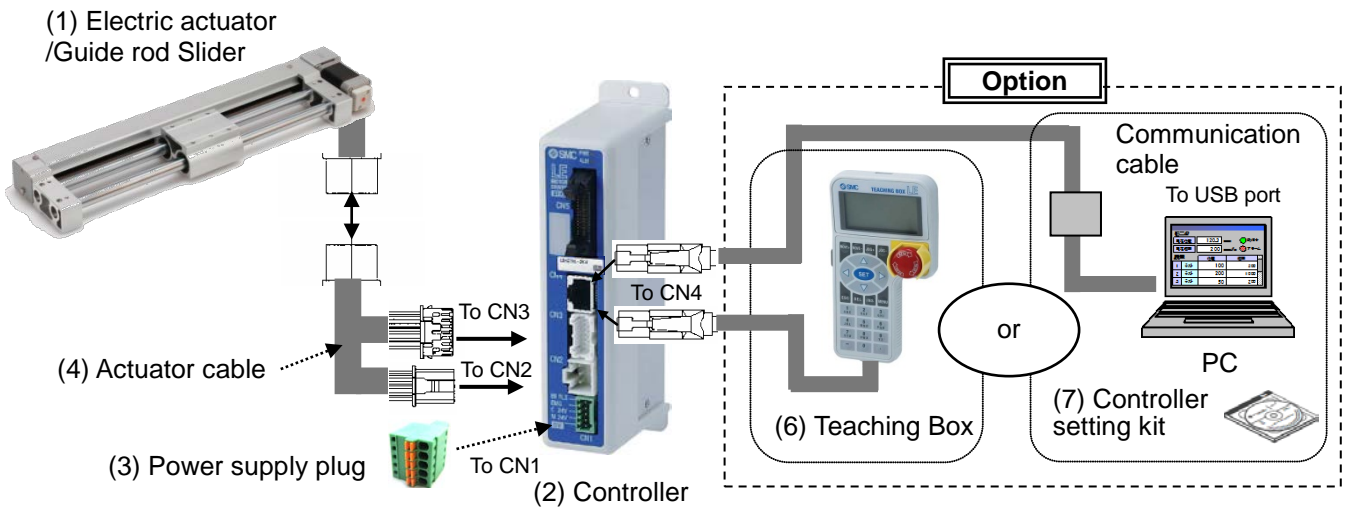

Table 2. Items to be prepared by the customer

Part name	Conditions
Power supply 24VDC Do not use the power supply with “Inrush-restraining type”	Refer to power consumption of each actuator/See 2.1 Specification on page 9 (Prepare the power supply that has capacity of “Moment max. power consumption” or more.)
Wire AWG20 (0.5mm ²)	Stripped wire length 8mm
Power supply plug Wiring	Connect the plus side of 24VDC to the C24V, M24V and EMG terminals of the power supply plug, and the minus side to the 0V terminal. When conformity to UL is required, the electric actuator and controller should be used with a UL1310 Class 2 power supply. <u>Step motor (servo 24VDC)</u> Push the open/close lever and insert the wire into the electrical wire entry

1.2 Controller setting software

1. Installation of software

With the controller setting software CD-ROM, install the communication unit software, following the "Software Installation procedure" (PDF)

2. Startup of software

After turning on the controller power supply start up the ACT Controller setting software

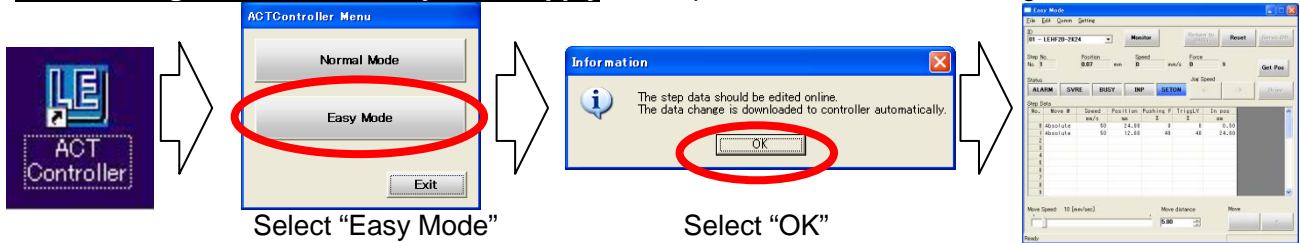

3. JOG Drive

a. Driving preparation: Servo On → Return to ORIG

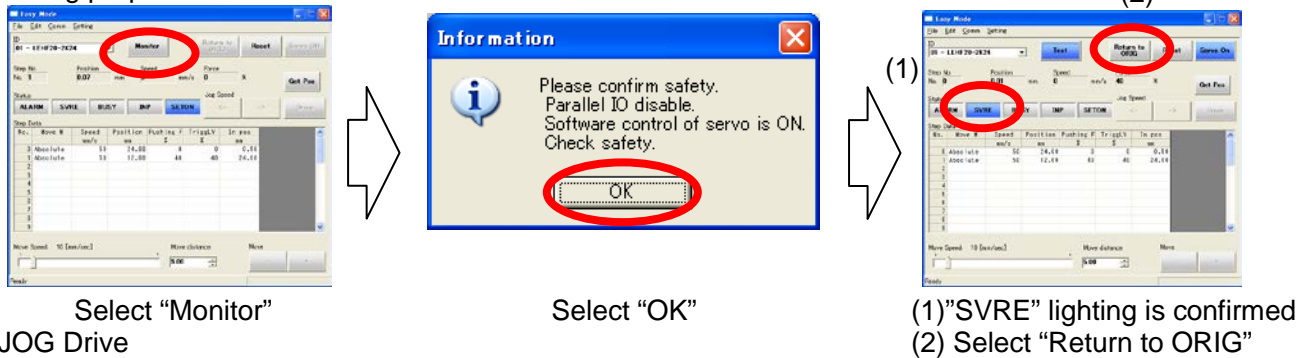

b. JOG Drive

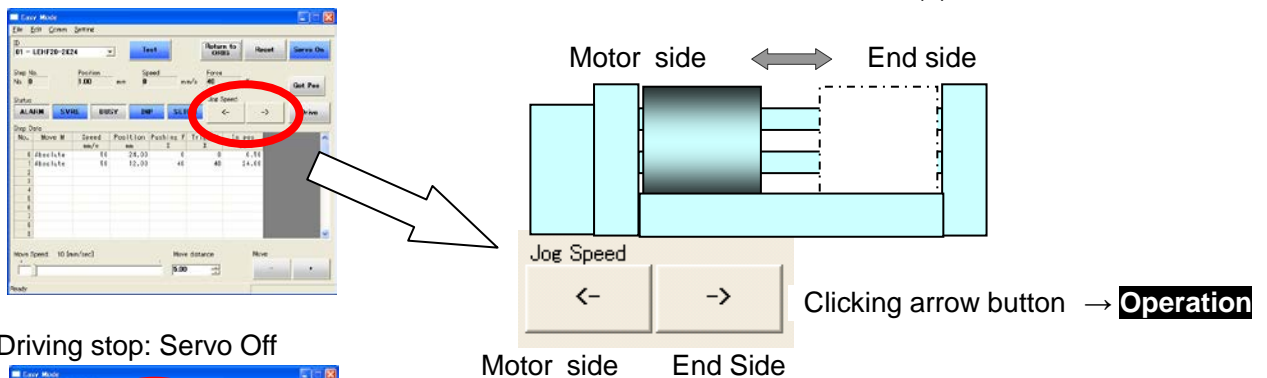

c. Driving stop: Servo Off

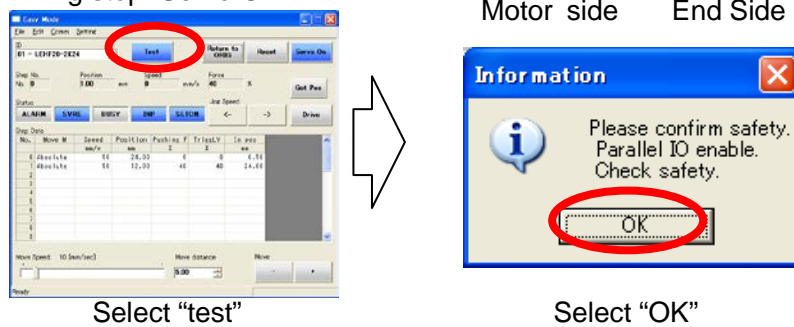

⚠ Caution

If an alarm is generated

When (1) "ALARM" is generated, release it by selecting (2) "Reset".
In the case of an alarm code that cannot be released with "Reset", turn the power supply OFF and ON again.

(1)



Note) For details of alarm codes, refer to the Controller Operation Manual.

4. TEST Drive / Step No.0 → No.1 → No.0...

a. Driving preparation: Servo On → Return to ORIG / Refer to “3.JOG Drive”.

b. TEST Drive

“Step No.0” Operation

Procedure 1:
Select “Step No.0”
You can select anywhere in the row



Procedure 2:
Select “Drive”

→ **Operation**

“Step No.1” Operation

Procedure 3:
Select “Step No.1”
You can select anywhere in the row



Procedure 4:
Select “Drive”

→ **Operation**

c. Driving stop : Servo Off / Refer to “3.JOG Drive”

5. Step data change

<“Step No.0” / Positioning operation> At the time of shipment, Step No.0 is set to positioning operation.

Step Data						
No.	Move M	Speed mm/s	Position mm	Pushing F %	TriggLV %	IN pos mm
0	Absolute	250	50.00	0	0	1.00

Change of positioning stop position
Position: 50mm → 30mm

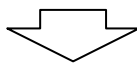

Input “30”

Step Data						
No.	Move M	Speed mm/s	Position mm	Pushing F %	TriggLV %	In pos mm
0	Absolute	250	30.00	0	0	1.00

For details of operation, and relationship between operation procedure and input/output signals, refer to “3.3 Step Data setting method” page 17 to 20.

6. Controller setting software screen explanation

Refer to the “Help / Easy mode” menu in the “ACT Controller” setting software.

1.3 Teaching box

1. Name

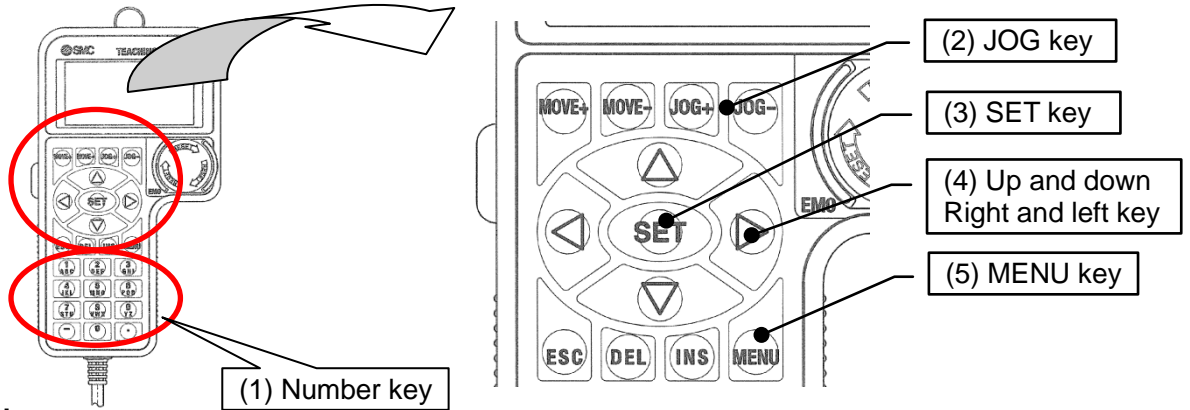

2. JOG Drive

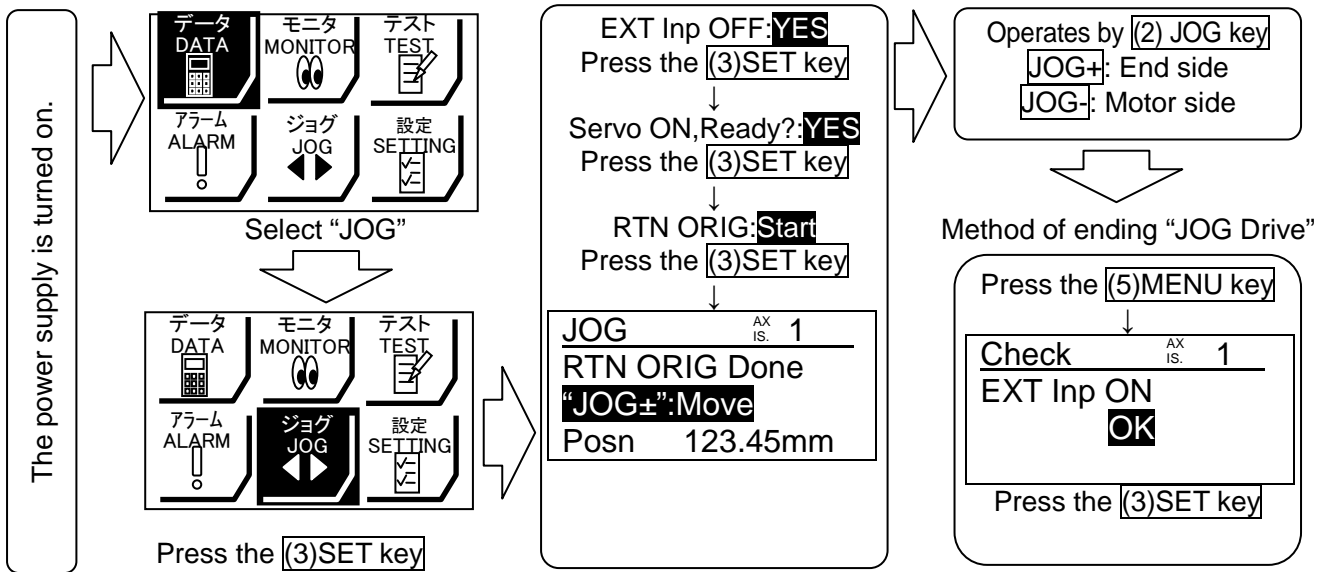

3. TEST Drive / Step No.0 → No.1 → No.0...

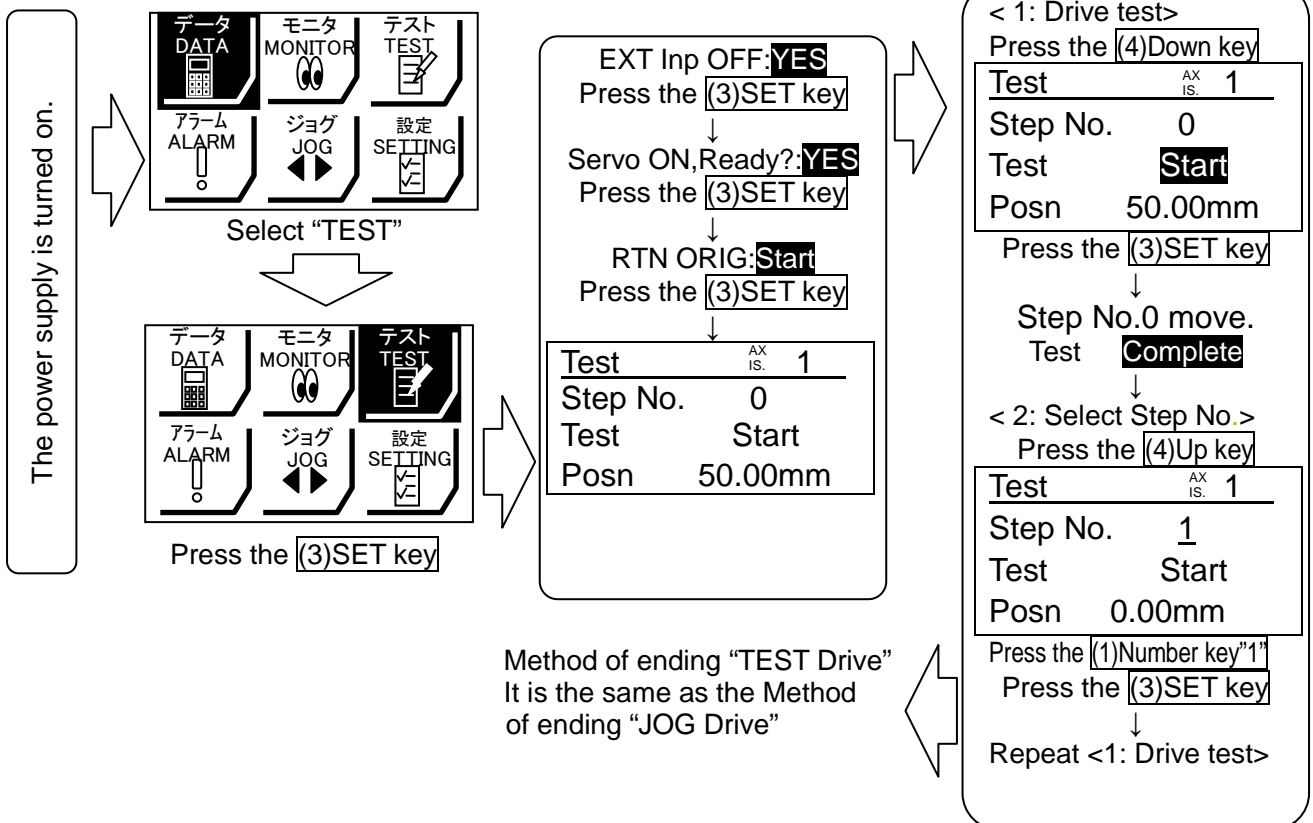

4. Step data change with positioning operation

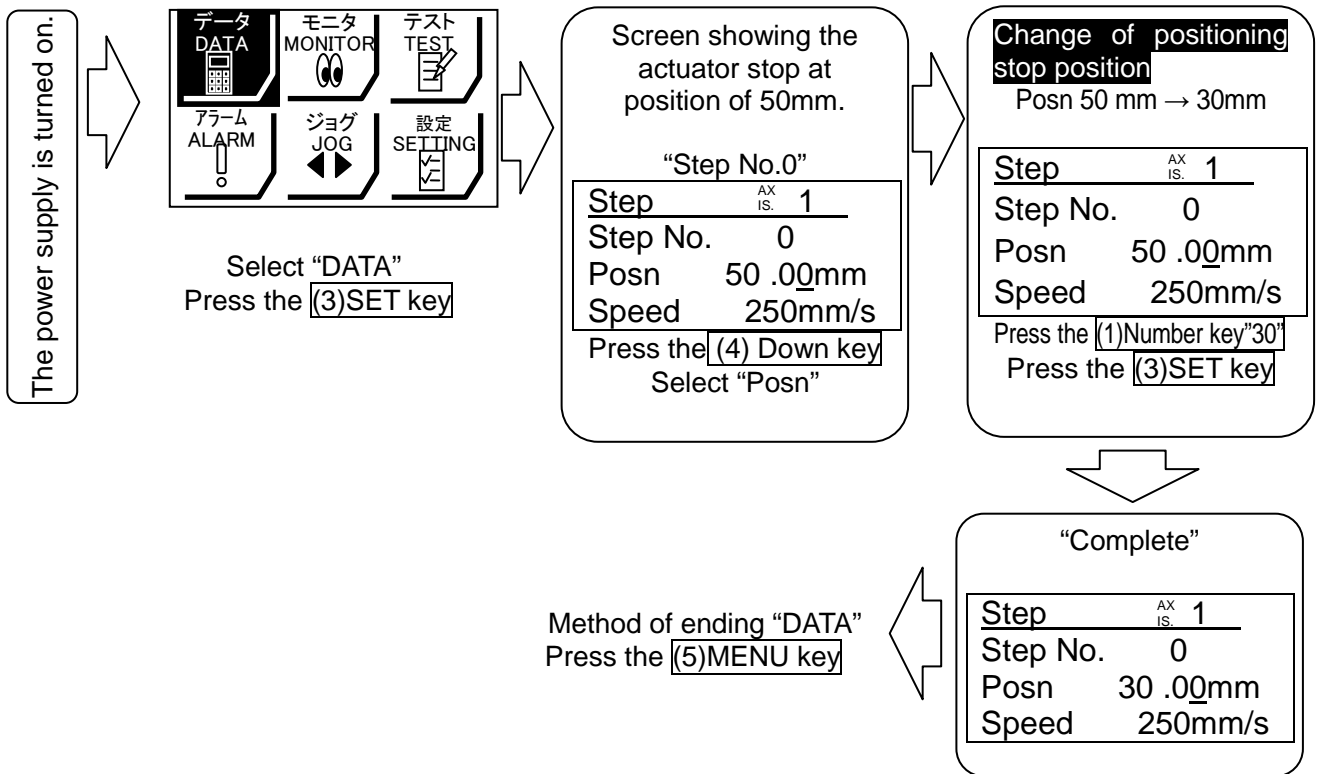

For details of operation, and relationship between operation procedure and input/ output signals, refer to section 3.3 "Step Data setting method" page 17 to 20.

5. Teaching box detailed explanation

Please refer to the teaching box manual.

2. Specification

2.1 Guide rod Slider LEL Series

Model		LEL25M	LEL25L	
Actuator specification	Stroke(mm) ^{Note 1)}	(100), (200), 300, 400, 500, 600, (700), (800), (900), (1000)		
	Work load(kg) ^{Note 2)}	Horizontal	3	5
		Wall mounting	2.5	5
	Speed(mm/s) ^{Note 2)}	48 to 500	48 to 1000	
	Max. Acceleration/Deceleration(mm/s ²)	3,000		
	Positioning repeatability (mm)	±0.08		
	Lost motion [mm] ^{Note 3)}	0.1 or less		
	Lead equivalent (mm)	48		
	Impact resistance/ vibration resistance (m/s ²) ^{Note 3)}	50 / 20		
	Drive method	Belt		
	Guide type	Slide bearing	Ball bushing bearing	
	Allowable external force(N) ^{Note 4)}	5		
	Operating temperature range (°C)	5 to 40		
Operating humidity range (%RH)	90 or less (No condensation)			
Electric specification	Motor size	□42		
	Type of Motor	Step motor (Servo 24VDC)		
	Encoder	Incremental A/B phase (800 pulse/rotation)		
	Rated voltage(VDC)	24 +/- 10%		
	Power consumption (W) ^{Note 5)}	32		
	Standby power consumption when operating(W) ^{Note 6)}	16		
	Momentary max. power consumption (W) ^{Note 7)}	60		
Lock specification	Type ^{Note 8)}	No excitation operating type		
	Holding force(N)	19		
	Power consumption (W) ^{Note 9)}	5		
	Rated voltage(VDC)	24 +/- 10%		

Weight

Stroke(mm)	(100)	(200)	300	400	500	600	(700)	(800)	(900)	(1000)	
Weight(kg)	LEL25M	2.13	2.47	2.82	3.17	3.52	3.87	4.21	4.56	4.91	5.26
	LEL25L	2.38	2.72	3.07	3.42	3.77	4.12	4.47	4.82	5.17	5.52
Additional weight for lock(kg)	0.26										
Additional weight for motor cover(kg)	0.04										
Additional weight for Magnet / Switch rail (kg)	0.04	0.05	0.06	0.08	0.09	0.11	0.12	0.14	0.15	0.17	

Note 1) The strokes shown in () are produced upon receipt of order.

Note 2) The speed is dependent on the workload. Check the following "Speed-workload graphs" for the selected model.

The workload is changed by the stroke and workload mounting condition. Check the following "Allowable dynamic moment graphs" for the selected model.

Also if the cable length exceeds 5m, the speed will be reduced 10% per 5m as the maximum.

Note 3) A reference value for correcting an error in reciprocal operation.

Note 4) Impact resistance:No malfunction occurred when the actuator was tested with a drop tester in both the stroke direction and perpendicular direction to the stroke. (The test was performed with the actuator in the initial state.)

Vibration resistance:No malfunction occurred in a test ranging between 45 to 2000 Hz, when the actuator was tested in both the stroke direction and a perpendicular direction to the stroke. (The test was performed with the actuator in the initial state.)

Note 5) Allowable external force is the allowable resistance when mounting cable duct and so on in parallel.

Note 6) The "Power consumption" (including the controller) is for when the actuator is operating.

Note 7) The "Standby power consumption when operating" (including the controller) is for when the actuator is stopped in the set position during operation.

Note 8) The "Momentary max. power consumption" (including the controller) is for when the actuator is operating.

This value can be used for the selection of the power supply.

Note 9) Only applies to actuators supplied with a lock.

Note 10) For the actuator with lock, please add the power consumption for the lock.

< Speed-Workload graph >

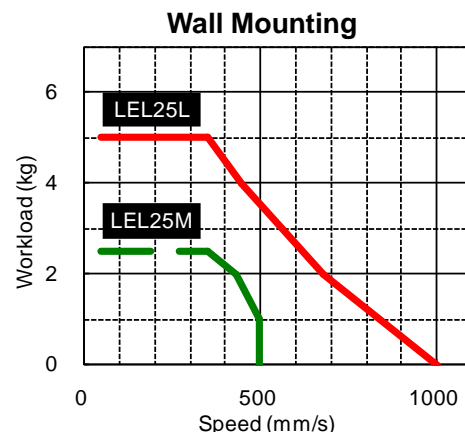
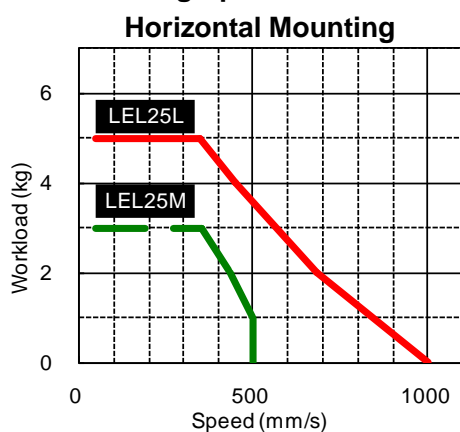

< Allowable dynamic moment graph >

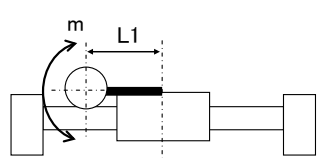
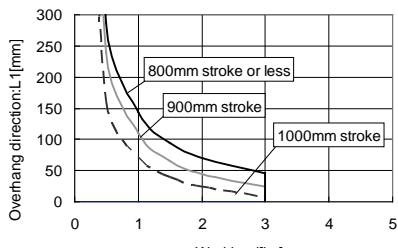
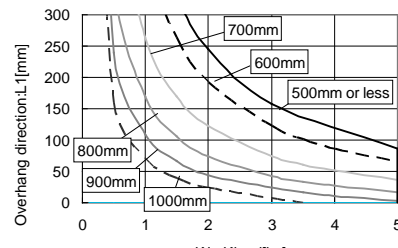
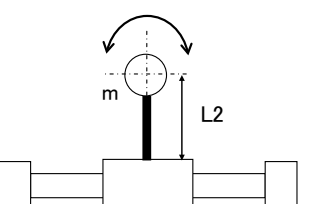
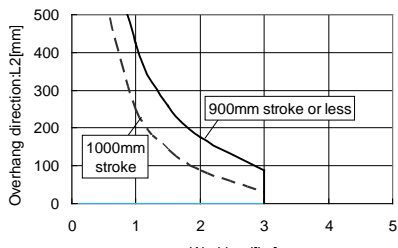
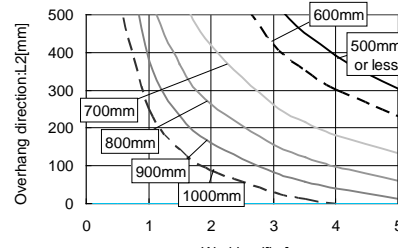
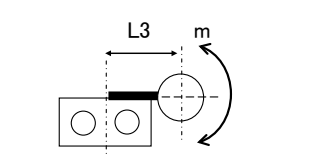
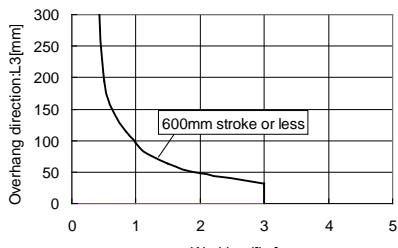
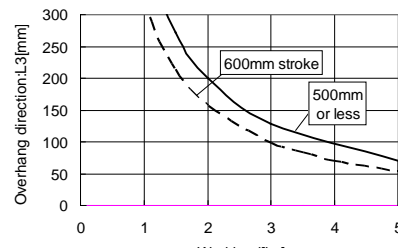
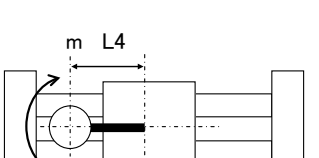
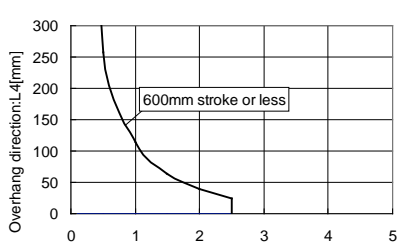
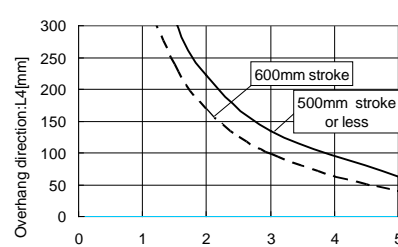
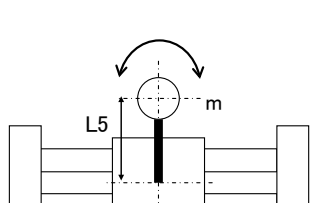
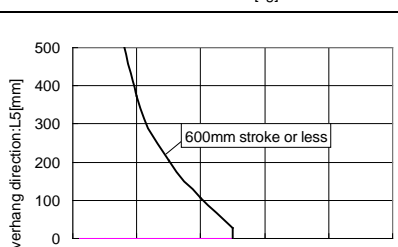
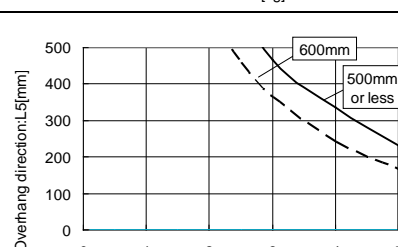
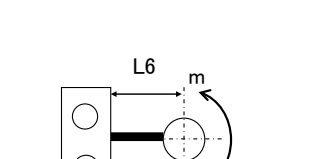
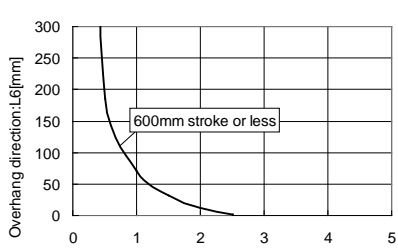
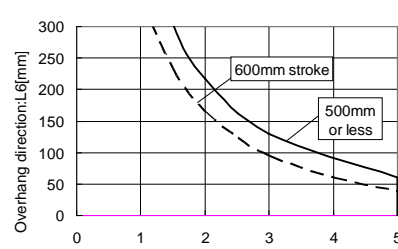
Mounting direction	Workload overhang direction M:Workload[kg] L:Amount of overhang toward center of gravity of work piece [mm]	Type	
		LEL25M	LEL25L
Horizontal Mounting			
			
			
Wall Mounting			
			
			

2.2 How to Order

LEL 25 □ T — 300 □ □ — S 1 6N 1 □
 ① ② ③ ④ ⑤ ⑥ ⑦ ⑧ ⑨ ⑩ ⑪

① Size

25

② Bearing type

M	Sliding bearing
L	Ball bushing bearing

③ Equivalent lead

T	48mm
---	------

④ Stroke

● Standard / ○ Produced upon receipt of order

	100	200	300	400	500	600	700	800	900	1000
LEL25	○	○	●	●	●	●	○	○	○	○

*Consult with SMC as all non-standard and non-made-to-order strokes are produced as special orders.

⑤ Motor option

Nil	Without option
B	With lock
C	With motor cover*

*When [With lock] is selected, [with motor cover] cannot be selected.

⑥ Magnet / Switch rail option

Nil	Without option
R	With magnet/switch rail

*After purchasing the "Nil" type, the magnet and switch rail cannot be attached afterwards.

⑦ Actuator cable type

Nil	Without cable
S	Standard cable* ¹
R	Robotic cable(Flexible cable)* ²

*¹The standard cable should be used on fixed parts. For using on moving parts, select the robotic cable.
 *² Only available for the motor type "Step motor".

⑧ Actuator cable length

Nil	Without cable	8	8m*
1	1.5m	A	10m*
3	3m	B	15m*
5	5m	C	20m*

*Produced upon receipt of order (Robotic cable only)

⑨ Controller type

Nil	Without controller	
6N	LECP6	NPN
6P	(Step date input type)	PNP
1N	LECP1	NPN
1P	(Programless type)	PNP
MJ	LECPMJ	-
	(CC-Link direct input type)	
C9	JXC9	-
	(EtherNet/IP direct input type)	

⑩ I/O cable length[m]*, 6*,1*,2*

Nil	Without cable
1	1.5
3	3
5	5

Communication plug*/ MJ*

Nil	Without communication plug connector
S	Straight type communication plug connector
T	T-branch type communication plug connector

Number of axis and type of power supply*/ C9*

1	1 axis, DC24V
---	---------------

* When "Without controller" is selected for controller types, I/O cable length cannot be selected.

⑪ Controller mounting

Nil	Screw mounting
D	DIN rail mounting*

*DIN rail is not included. Order it separately.

⚠ Caution

The actuator body and controller are sold as a package.

If when only the actuator is purchased separately, confirm that the combination of the controller, which you have and the actuator is compatible. / page28 Notes5.3 ⚠ Caution(1)

<Be sure to check the following before use.>

- (1) Check that actuator label for model number. This matches the controller.
- (2) Check Parallel I/O configuration matches (NPN or PNP).

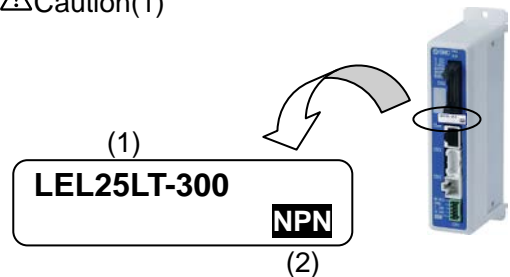

2.3 Construction

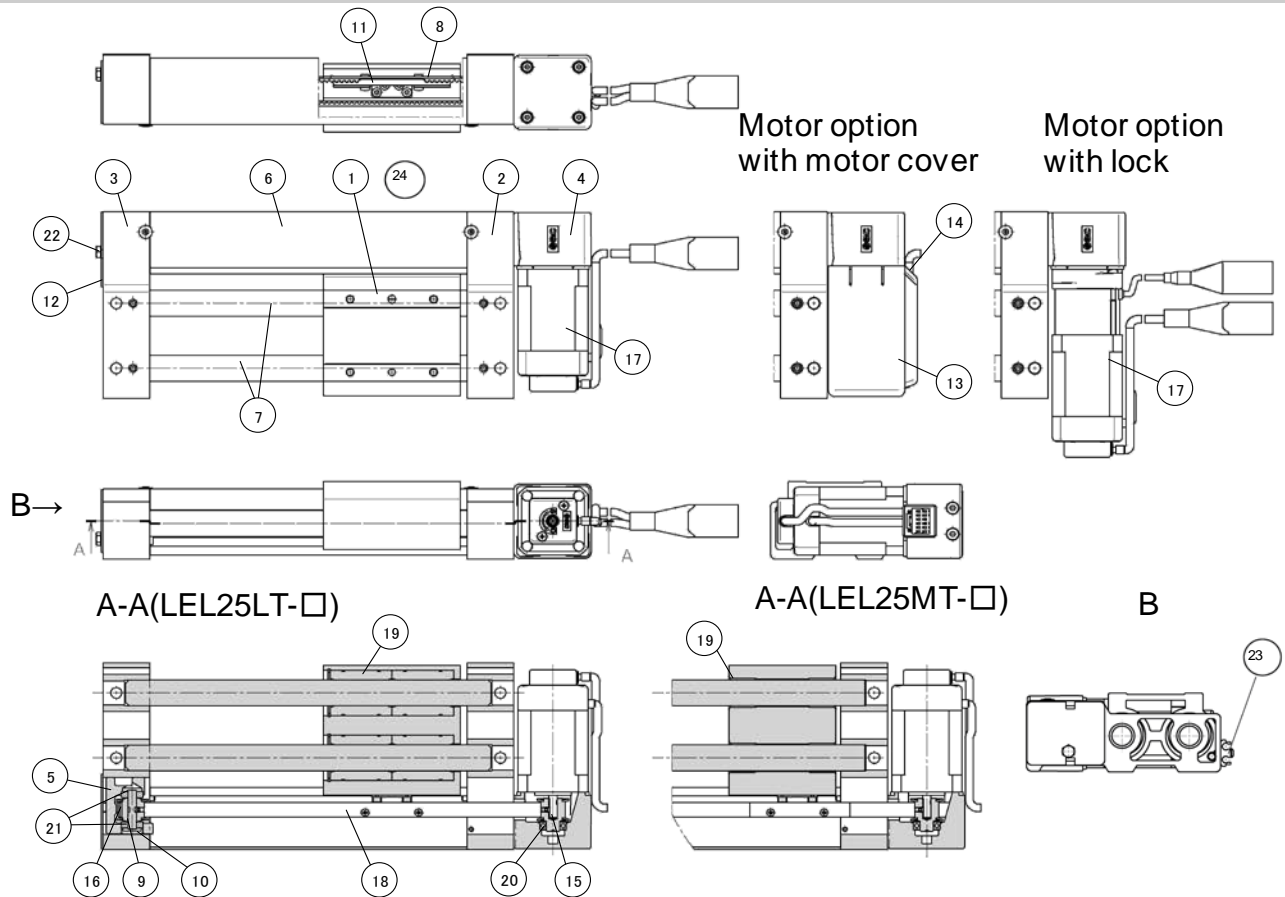

No.	Description	Material	Remarks
1	Table	Aluminium alloy	Anodized
2	Motor end plate	Aluminium alloy	Anodized
3	End plate	Aluminium alloy	Anodized
4	Motor mount	Aluminium die-cast	Painting
5	Pulley holder	Aluminium alloy	
6	Belt cover	Aluminium alloy	Anodized
7	Guide rod	Carbon steel	Hard chromating
8	Belt holder A	Carbon steel	Chromating
9	Pulley shaft	Stainless steel	
10	Spacer	Aluminium alloy	
11	Belt holder B	Aluminium alloy	
12	Tension plate	Aluminium alloy	Anodized
13	Motor cover	Synthetic resin	"With motor cover" only
14	Grommet	Synthetic resin	"With motor cover" only
15	Motor pulley	Aluminium alloy	Anodized
16	End pulley	Aluminium alloy	Anodized
17	Motor	-	
18	Belt	-	
19	Slide bearing	-	"LEL25MT"
	Ball bushing bearing	-	"LEL25LT"
20	Bearing	-	
21	Bearing	-	
22	Tension adjustment bolt	Carbon steel	
23	Switch rail	Aluminium alloy	"With magnet / switch rail" only
24	Magnet	-	"With magnet / switch rail" only

3. Product Outline

3.1 System construction

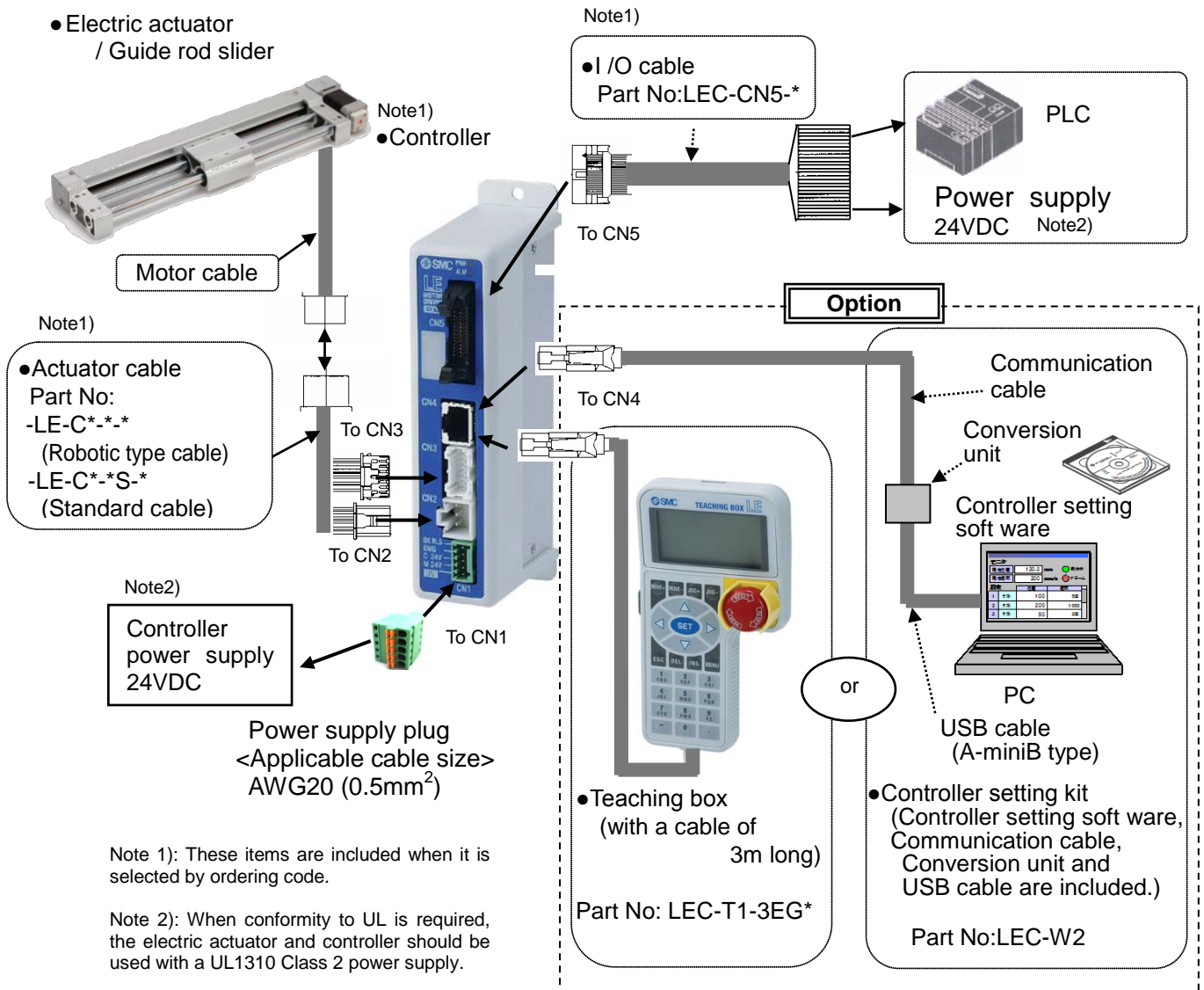

⚠ Warning

Refer to the operation manual of the LEC (controller) for detailed wiring.

/ See 4 Wiring of cables on page 26.

Communication cable is to be connected to PC by USB cable through conversion unit.

Do not connect the teaching box directly to the PC.

Use only specified cables otherwise there maybe fire risk and damage.

The actuator and controller are sold as a package.

If when only the actuator is purchased separately, confirm that the combination of the controller, which you have and the actuator is compatible.

/ See 5.3 Caution (1) on page 28

<Be sure to check the following before use.>

(1) Check that actuator label for model number.

This matches the controller.

(2) Check Parallel I/O configuration matches (NPN or PNP).

(1)
LEL25LT-300

NPN

(2)



3.2 Setting Function

Refer to the operation manual of the controller (LEC series) for the detail of the setting function.

Easy Mode for simple setting

>Selcect “Easy mode” for instant operation.

Controller setting software

- Setting and operation, such as the step data setting, test drive and JOG / fixed-distance moving, can be performed on the same page.

Speed setting of JOG / fixed distance

JOG moving

Start testing

Positioning data setting

Fixed distance moving

Teaching box

- Setting and operation by the simple screen without scrolling.
- Select function by the iconized menu at the first page.
- Step data setting and monitoring at the second page.

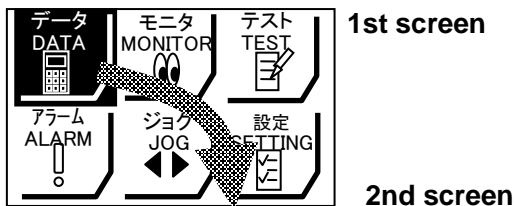

Data	Axis 1
Step No.	0
Posn	123.45mm
speed	400mm/s

It can be registered by “SET” after entering the values.

Example of setting the step data

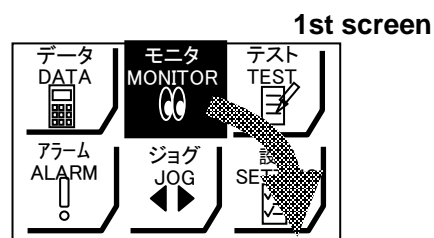

Monitor	Axis 1
Step No.	1
Posn	12.34mm
speed	50mm/s

Operation status can be checked

Example of checking the operation status

Normal mode for the detailed setting

> **Select "Normal mode" if the detailed setting are necessary.**

- Step data can be set in detail.
- Parameters can be set.
- Signals and terminal condition can be monitored.
- JOG and fixed distance movement, return to origin position, test operation and testing of compulsory output can be done.

Controller setting soft ware

- Every function, step data, parameter, monitor and teaching are indicated in a different window.

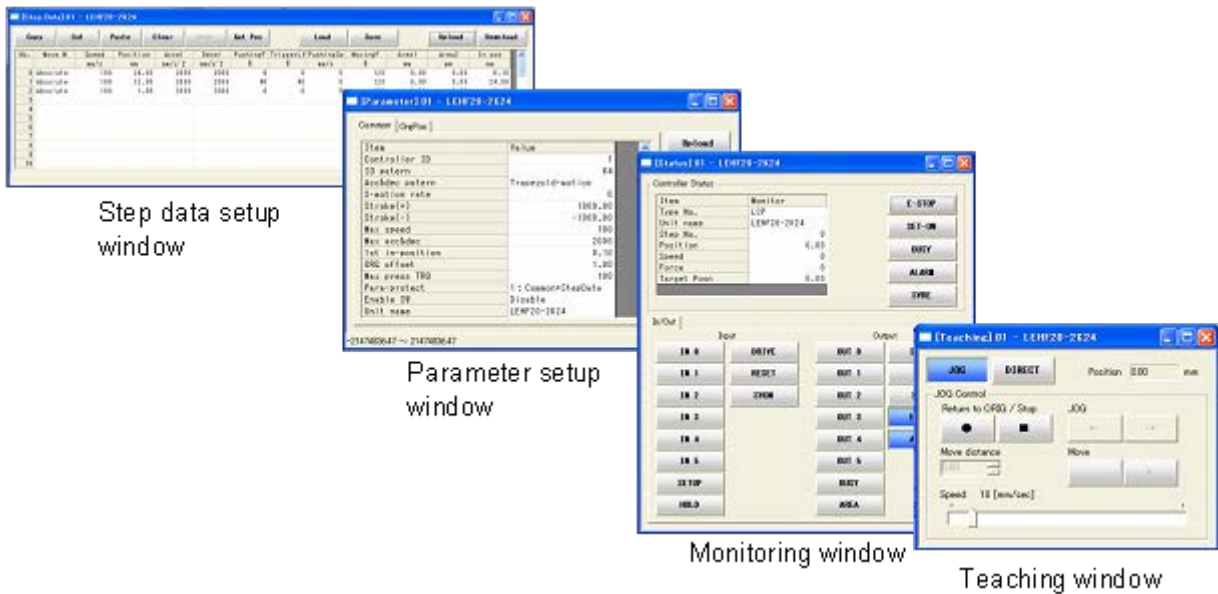

Teaching box

- The data in the controller can be saved / forwarded in this teaching box.
- Continuous test operation can be made after specifying five step data.

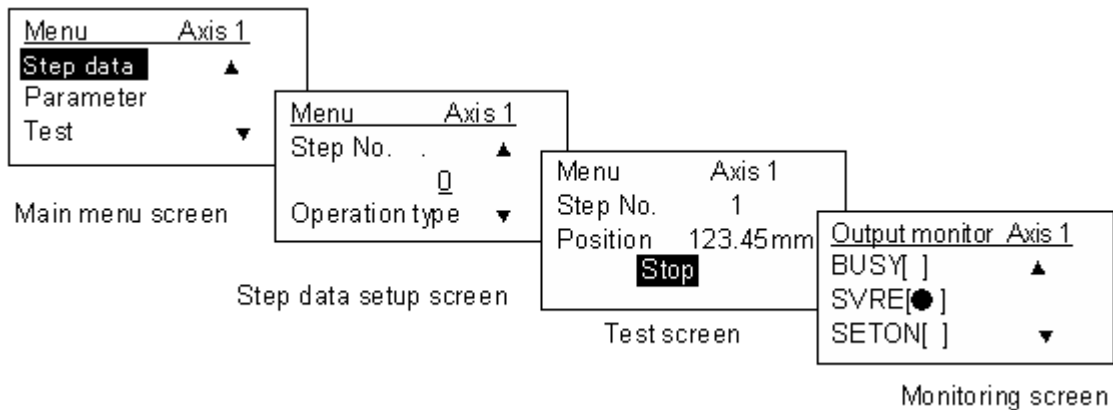

Controlled items

PC: Controller setting software

TB: Teaching box

O: Available function, x: Not available function

Function		Content	Easy mode		Normal mode
			PC	TB	PC
Step data	Movement method	Can be selected of absolute/relative position move	○	×	○
	Speed	Can be set in units of 1mm/s.	○	○	○
	Position	Can be set in units of 0.01mm.	○	○	○
	Acceleration Deceleration	Can be set in units of 1mm/s ² .	○	○	○
	Pushing force	Can be set in units of 1%. / In case of positioning operation: Set to 0%. (Not available in this product)	×	×	×
	Trigger LV	Trigger level of target pushing force when pushing operation Can be set in units of 1%. (Not available in this product)	×	×	×
	Pushing speed	Can be set in units of 1mm/s. (Not available in this product)	×	×	×
	Moving force	100% at step motor, (Not changeable).	○	×	○
	Area output	Can be set in units of 0.01mm.	○	×	○
In position	During positioning operation: Width to the target position. It should be set to 1 or more.	○	×	○	
Parameter (Excerpt)	Stroke(+)	+ side limit of position. (Can be set in units of 0.01mm).	×	×	○
	Stroke(-)	- side limit of position (Can be set in units of 0.01mm).	×	×	○
	ORIG direction	Direction when returning to home position can be set.	×	×	○
	ORIG speed	Speed when returning to home position can be set.	×	×	○
	ORIG ACC	Acceleration when returning to origin can be set.	×	×	○
Test	JOG	It can make continuous operation at the set speed while the switch is being pressed	○	○	○
	MOVE	It can make test operation at the set distance and speed from the current position when the switch is pressed.	○	×	○
	Return to ORIG	Test of return to origin can be done.	○	○	○
	Test drive	The operation of the specified step data can be tested.	○	○	○ (Continuous operation)
	Forced output	ON/OFF of the output terminal can be tested.	×	×	○
Monitor	DRV mon	Current position, current speed, current force and the specified step data No. can be monitored.	○	○	○
	In/Out mon	Current ON/OFF status of the input and output terminal can be monitored.	×	×	○
ALM	Status	The alarm currently being generated can be confirmed.	○	○	○
	ALM Log record	The alarm generated in the past can be confirmed.	×	×	○
File	Save - Load	The step data and parameter of the objective controller can be saved, forwarded and deleted.	×	×	○
Other	Language	Language can be changed to Japanese / English.	○ *3	○ *2	○ *2 *3

*1 Every parameter is set to the recommended condition before shipment from the factory. Only change the setting of the items which require adjustment.

*2 Teaching box: In the Normal mode the teaching box can be set to work in English or Japanese.

*3 Controller setting software: Can be installed by selecting English version or Japanese version.

3.3 Step data setting method

Refer to the operation manual of the controller (LEC series) for details.

This operation manual specifies the electric actuator guide rod slider, if an actuator other than the guide rod slider is used, refer to the operation manual of each type of actuator and controller (LEC series) regarding the description of step data.

⚠ Caution

The actuator body and controller are sold as a package.

If when only the actuator is purchased separately, confirm that the combination of the controller, which you have and the actuator is compatible. / See 5.3⚠Caution(1) on page 28

<Be sure to check the following before use.>

- (1) Check that actuator label for model number.
This matches the controller.
- (2) Check Parallel I/O configuration matches (NPN or PNP).

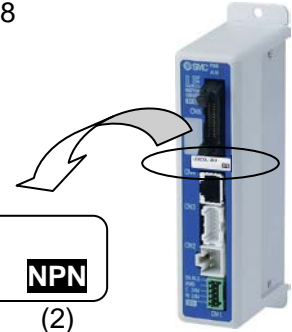
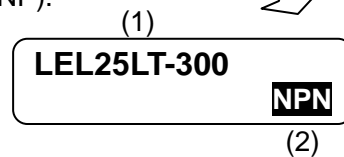

Positioning operation

In the positioning operation, the actuator transfers to and stops at the target position.

The following image shows the set items and operation.

<Confirmation of reaching the target position during the positioning operation>

When the table of actuator reaches the range of the target position, the “target position reaching signal” 【INP】 (in position) is outputted.

When the table of actuator enters the range of 【in position】, the INP output signal turns on.

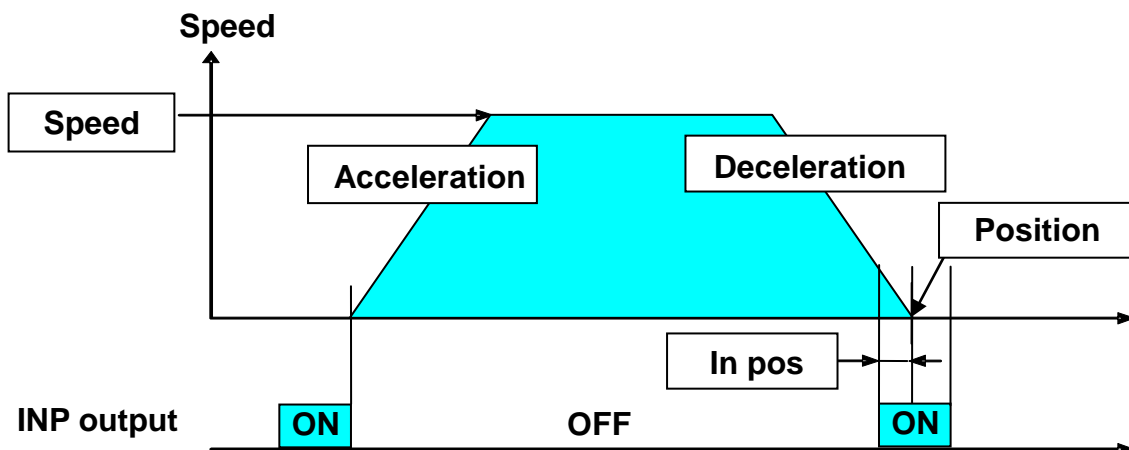

<Items and set values in positioning operation> Step No. 1: Positioning operation

	a	b	c	d	e	f	g	h	i	j	k	
No.	Move M	Spee mm/s	Position mm	Accel mm/s ²	Decel mm/s ²	Pushing F %	TriggLV %	Pushing Sp mm/s	Moving F %	Area 1 mm	Area 2 mm	In pos mm
0	ABS	250	50.00	3000	3000	0	0	0	100	48.00	50.00	1.00
1	ABS	250	0.00	3000	3000	0	0	0	100	0.00	2.00	1.00

[◎] Need to be set - [○] Need to be adjusted as required.

[x] Not used. Items don't need to be changed in positioning operation.

- a < ◎ Movement Method > When the absolute position is required, set Absolute
When the relative position is required, set Relative
→ Absolute: Distance from the origin position. / General setting method
Relative: Feed from the current position. / This is used when simplified data.
- b < ◎ Speed > Transfer speed to the target position.
- c < ◎ Position > Target position.
- d < ○ Acceleration > The parameter which defines how rapidly the actuator reaches the speed set in b.
The higher the set value, the faster it reaches the speed set in b.
- e < ○ Deceleration > The parameter which defines how rapidly the actuator comes to stop.
The higher the set value, the quicker it stops.
- f < ◎ Pushing force > Set **0**.
(If values other than 0 set the operation will be changed to the pushing operation.)
- g < x Trigger LV > For pushing operation only. Not applicable for this product.
- h < x Pushing speed > For pushing operation only. Not applicable for this product.
- i < x Moving force > Max. Force at the positioning operation.
The force is automatically adjusted corresponding to the load.
Set [100] % at step motor. (Not changeable)
- j < ○ Area1, Area2 > This is the condition that turns on the AREA output signal.
The setting condition should be **Area 1 < Area 2**
It is possible to set at relative operation too.
The position will be Absolute (position from the origin).
Example) In case of Step no.1
[AREA] output signal is outputted between Area 1: 0 and Area 2: 2.
- k < ○ In position > This is the condition that turns on the INP (in position) output signal.
→When the electric actuator reaches the range of the target position, the INP output signal is output.
When it is necessary to output the target position reaching signal earlier, make the value larger.
Note) Set the value more than [1] (Default).
Example) In case of Step no.1
Position: 0 + In position: 1 = [INP] is outputted from the value of 1.

Example of step data input (1)

< Positioning operation - 【INP】output signal, 【AREA】output signal >

No.	Move M	Spee mm/s	Position mm	Accel mm/s ²	Decel mm/s ²	PushingF %	TriggerLV %	PushingS mm/s	MovingF %	Area1 mm	Area2 mm	In pos mm
0	Absolute	100	100.00	3000	3000	0	0	0	100	80.00	90.00	1.00

- Step data no.0: Positioning operation (It moves from Position: 0[mm] to Position: 100[mm])

Condition 1) The 【AREA】output signal is not used.

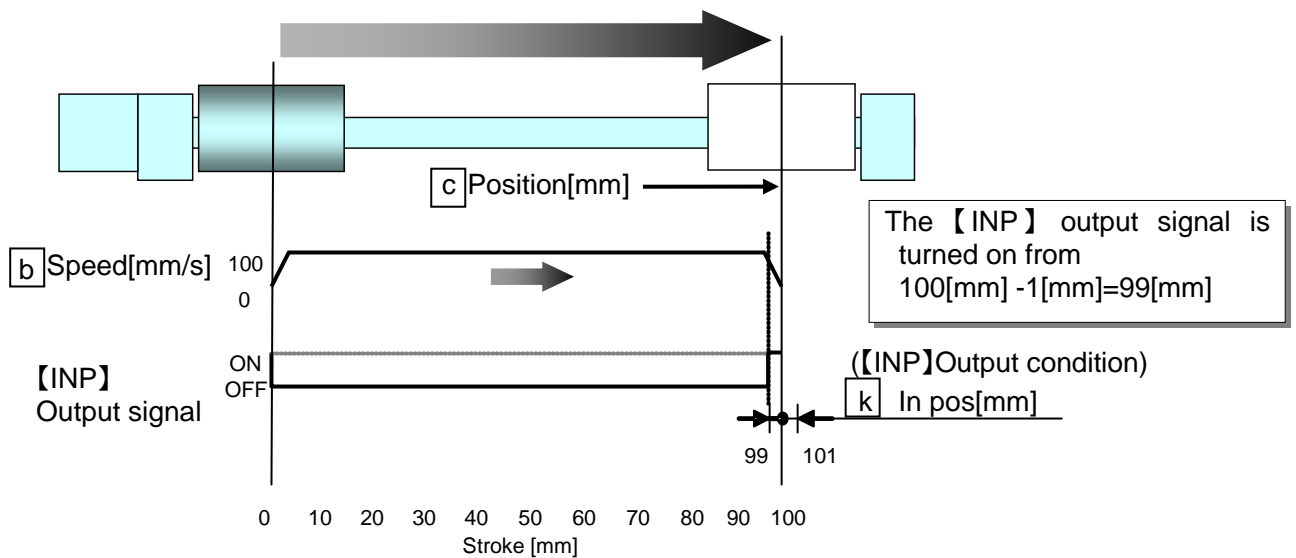

Condition 2) The 【AREA】output signal is used.

*The 【AREA】output signal is a signal output when the table traverses through a certain range (The step data: from Area 1 to Area 2).

This feature is useful when an output to check the table position at intermediate stroke is required.

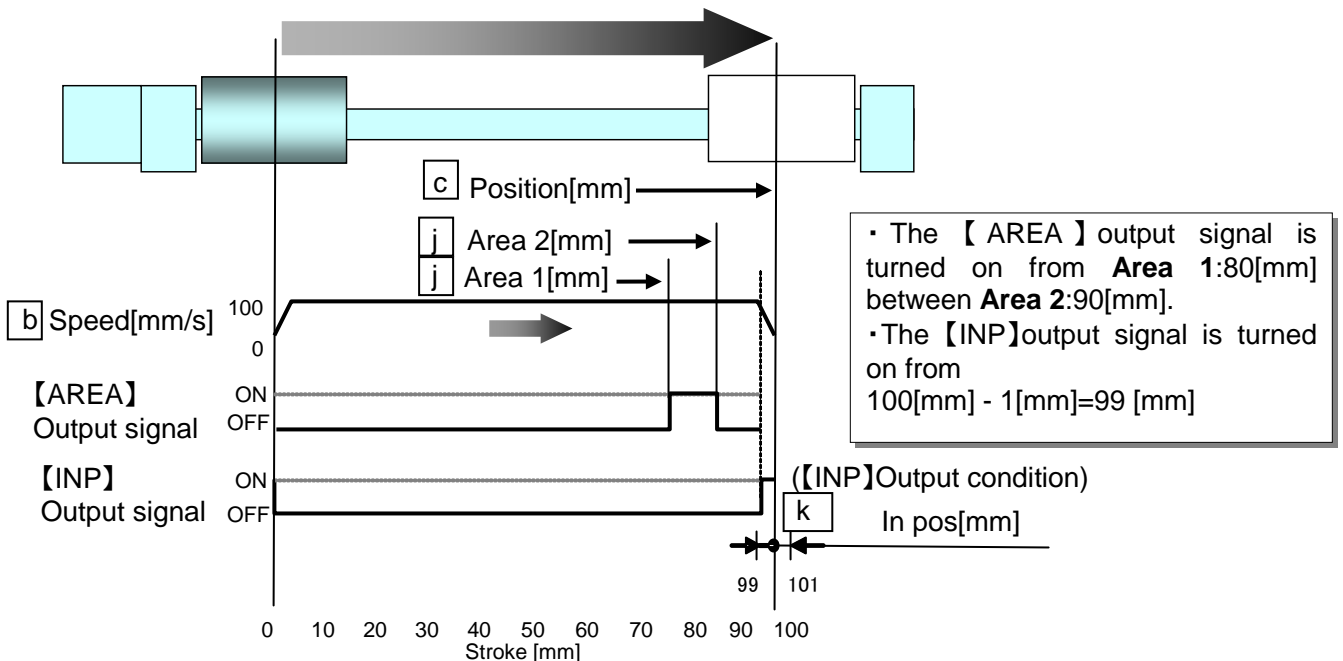

Example of step data input (2)

< Positioning operation – Relative >

	a	b	c	d	e	f	g	h	i	j		k
No.	Move M	Speed mm/s	Position mm	Accel mm/s ²	Decel mm/s ²	PushingF %	TriggerLV %	PushingSp mm/s	MovingF %	Area1 mm	Area2 mm	In pos mm
0	Relative	100	10.00	3000	3000	0	0	0	100	10.00	20.00	1.00
1	Relative	100	-10.00	3000	3000	0	0	0	100	10.00	20.00	1.00

*Absolute: Distance from the origin position. / General setting method

*Relative: Feed from the current position. / This is used when simplified data.

Condition 1) 30mm position → **Step no.0** → **Step no.0** (Move Method: Relative)

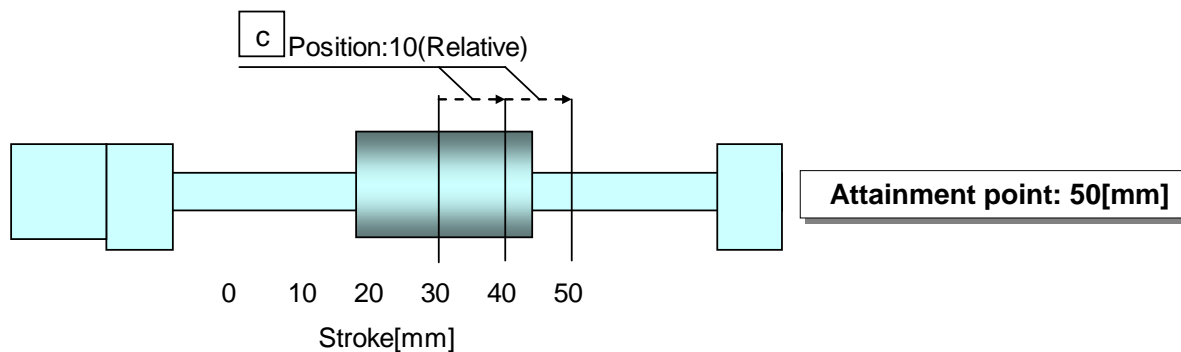

Condition 2) 30mm position → **Step no.1** → **Step no.1** (Move Method: Relative)

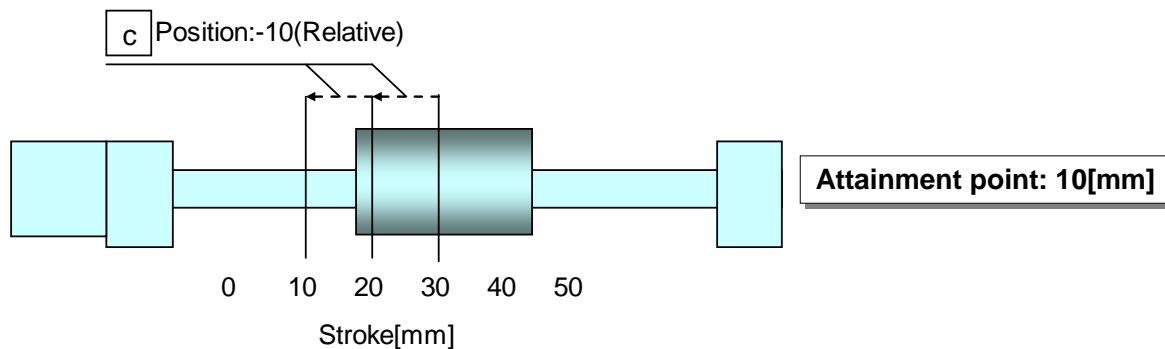

Operating procedure and input / output signals for each operation

The input / output signal and the operation description for operating this electric actuator are as follows.

1) Signals along with the operation procedures

In case the operation order is

1. Supply power to the motor → 2. Return to origin → 3. Step no. 1 → 4. Step no. 2 → 5. Cut power to the motor

Procedure	Input signal	Output signal for the input signal	Operation description
1	SVON(Servo on)[●]	SVRE(Servo ready) [●]	Power is supplied to the motor, and detection of the magnetic pole position starts. => Completion.
2	SETUP [●]	SETON [●] INP(In position)[●]	Returning to the origin starts. =>Completion.
3	IN0 [●] IN1 [] IN2 [] IN3 [] IN4 [] IN5 [] ↓ DRIVE [●] => [] note.3)5)	OUT0 [●] OUT1 [] OUT2 [] OUT3 [] OUT4 [] OUT5 [] } note.3)4) ↓ After reaching of target position, INP [●] After stopping motion, BUSY []	Step no. 1 is selected, and the operation starts. =>Complete.
4	IN0 [] IN1 [●] IN2 [] IN3 [] IN4 [] IN5 [] ↓ DRIVE [●] => [] note.3)5)	OUT0 [] OUT1 [●] OUT2 [] OUT3 [] OUT4 [] OUT5 [] } note.3)4) ↓ After reaching of target position, INP [●] After stopping motion, BUSY []	Step no. 2 is selected, and the operation starts. =>Complete.
5	SVON []	SVRE [] SETON [●] note.2) INP [●]	Power to the motor is cut.

Note 1) [●] means ON, [] means OFF.

Note 2) The origin has been recognized when the operation is repeated, so it can operate without the procedure item 2.

Note 3) The "OUT*" signals are reset during the rising edge of the Drive signal. The "OUT*" signal which follows the "IN*" signal are outputted at the falling edge of the "drive" signal.

Note 4) When the alarm is generated, the alarm group is displayed.

Please confirm the controller (LEC series) manual for a detailed content of the alarm.

The alarm becomes invalid when the "EMG"(Stop) or "RESET" is commanded.

Note 5) Leave an interval of 15ms (the recommendation is 30ms) or more between input signals and maintain the state of the signal for 15ms (the recommendation is 30ms) or more, because PLC processing delays and controller scanning delays can occur.

2) Signals when Stopped: In the event when “EMG” is used

/ See 5.1 Warning (9) on page 27

The operating sequence is 1. “Stop” → 2. Release the “Stop”

Procedure	Input signal	Output signal for the input signal	Operation description
1	EMG: Not energizing (TB / Stop switch: Locking)	*ESTOP[] SVRE [] SETON [●]	Power to the motor is cut by the “Stop” command regardless of whether it is operating or stopping.
2	EMG: Energizing (TB / Stop switch: Releasing)	*ESTOP[●] SVRE [●] SETON [●] Note 2)	The stop is released.

Note 1) [●] means ON, [] means OFF and *means negative logic.

TB means teaching box.

Note 2) SETON signal does not change after releasing the “STOP”.

3.4 Parameter setting method

Initial setting for the basic parameters

Refer to the controller's (LEC series) operation manual for detail.

As the "basic parameter" is unique data of each actuator, if an actuator other than the "electric actuator / guide rod slider" is used, refer to the operation manual of each actuator and the controller's (LEC series) operation manual for the basic parameter.

Description(Extract)	Initial input value	Input range
Controller ID	1	1 to 64 note1)
IO pattern	1: 64	-
Acceleration / deceleration pattern	1: Trapezoid - motion	-
S-motion ratio	0	-
Stroke (+)	10000	10000
Stroke (-)	-10000	-10000
Maximum speed	Max. speed of each product	Step data input limit: Max. speed of each product
Maximum acceleration / deceleration	3000	to 3000
Default In positioning	1	1 to product stroke
Origin offset note2)	0.00	Origin direction: CCW -10000 + "product stroke" to 9999 Origin direction: CW -9999 to +10000 - "product stroke"
Maximum pushing force	-	-
Parameter protect	1: Common + StepData	Changeable parameter 1: Common + StepData, 2: Common
Enable switch	2: Disable	Select 1:Enable or 2:Disable when using a teaching box
Model name	Part no. of each product	Only the English characters and numbers are changeable.
W-area output end 1	0.00	-
W-area output end 2	0.00	-
Origin correction data	0.00	-

Note 1) Become effective after restarting the controller.

Note 2) The origin offset is used for the "return to origin". / See <Origin offset> on page 25.

Initial setting for the ORIG parameters

Refer to the controller's (LEC series) operation manual for detail.

As the "ORIG parameter" is unique data of each actuator, if an actuator other than the "electric actuator

Description(Extract)	Initial input value	Input range
ORIG direction	2: CCW <small>note1)</small>	1: CW, 2: CCW
ORIG mode	1: Stop	-
ORIG limit	100	-
ORIG time	200	-
ORIG speed	80	-
ORIG ACC /DEC	1000	-
Creep speed	60	-
ORIG sensor	0: Disable	-

/ guide rod slider" is used, refer to the operation manual of each actuator and the controller's (LEC series) operation manual for the "ORIG parameters".

Note1) CCW direction: motor side origin, CW direction: end side origin. Become effective after restarting the controller.

Note2) Return to origin cannot be done during operation.

<Return to origin>

It is necessary to establish the origin before commencing any other operation.

1) Sequence of return to origin

Input the origin signal → Move to the origin → Stop moving (pushing) → Move to the opposite direction → Origin
 (Moving distance LEL25MT:3mm, LEL25LT:4mm/ not changeable)

⚠ WARNING

Do not alter any parameter except the ones shown. Or else there is a possibility of damage.

2) Method of changing direction of origin

Use the following procedures when you change the direction of the origin. Initial setting of origin is motor side.

Procedure 1- In the [Parameter] 01 dialogue box select the ORIG tab.

And the direction of the origin is changed from 2 (CCW) to 1(CW).

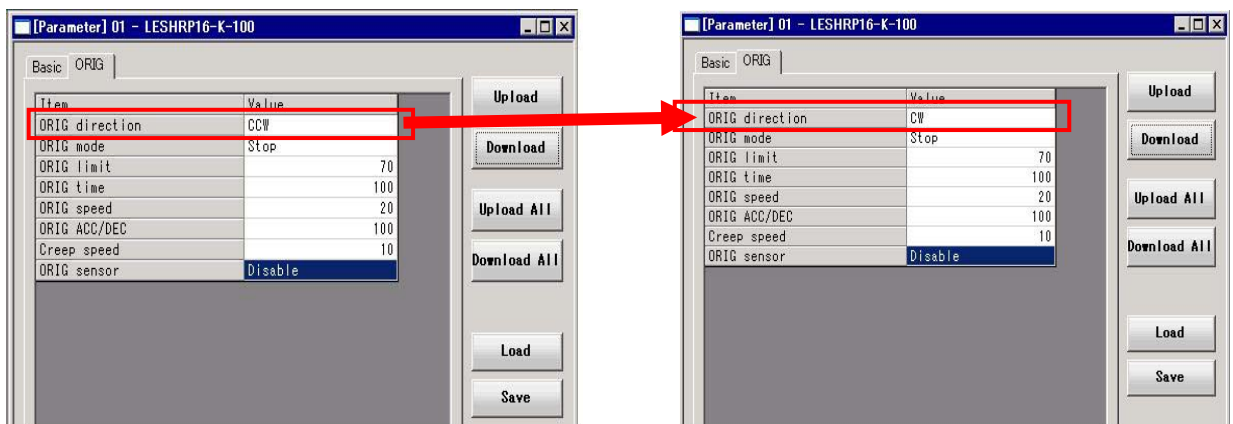

Procedure 2- In the [Parameter] 01 dialogue box press the "Download All" radio button.

Procedure 3- Power supply OFF (→ Power supply ON)

<Origin offset>

The origin offset means the value of the origin. ("Origin offset"=The display value of origin)

When the parameter "Origin offset" is changed, the display value of origin is changed. The step data should be checked again.

Please refer to basic parameter on page 23 for changing of "Origin offset".

Initial input value: "Origin offset"=0. Move in the opposite direction (Moving distance LEL25MT: 3mm, LEL25LT: 4mm / Not changeable) by the return to origin becomes "origin =0".

a) In case of Origin direction: CCW

Example) Actuator stroke 50mm

"Origin offset"=0 (Initial input value)

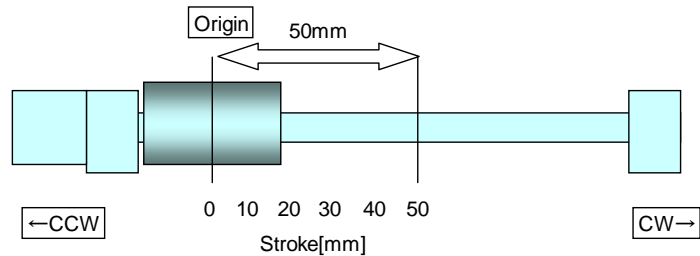

Changed to "Origin offset"=10

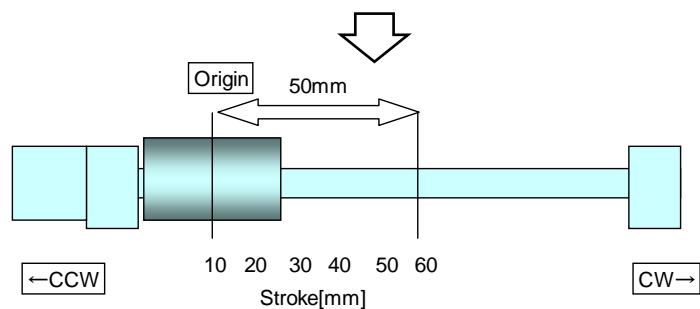

b) In case of Origin direction: CW

Example) Actuator stroke 50mm

"Origin offset"=0 (Initial input value)

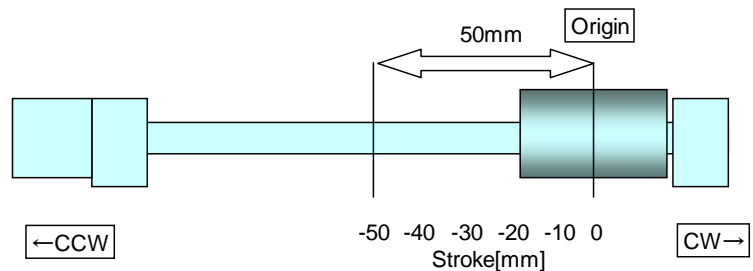

Changed to "Origin offset"=10

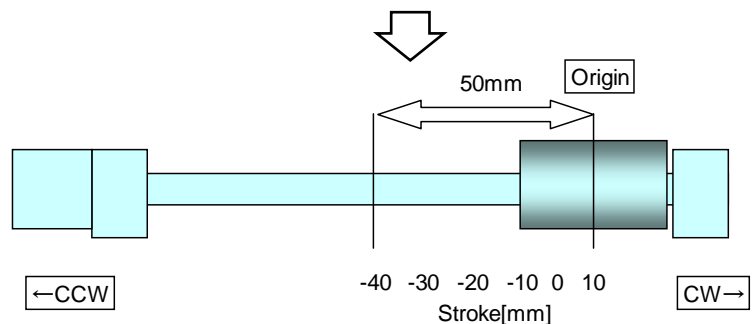

Changed to "Origin offset"=-10

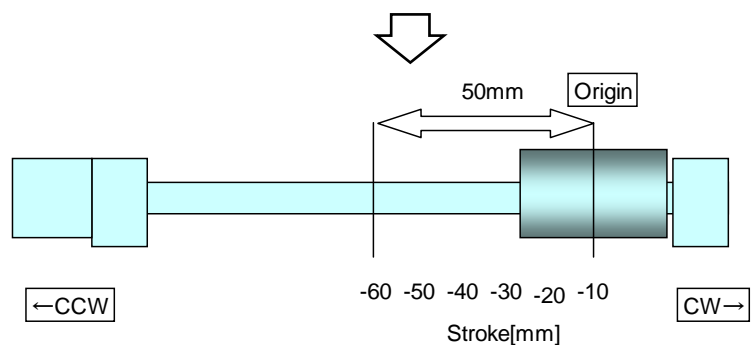

4. Wiring of cables / Common precautions

Warning

1. **Adjusting, mounting or wiring change should never be done before disconnecting the power supply to the product.**
Electrical shock, malfunction and damage can result.
2. **Do not disassemble the cables.**
Use only specified cables.
3. **Do not connect or disconnect the wires, cables and connectors when the power is turned on.**

Caution

1. **Wiring securely. Do not apply any voltage to the terminals other than those specified in the Operation Manual.**
2. **Wire the connector securely.**
3. **Take appropriate measures against noise.**
Noise in a signal line may cause malfunction. As a countermeasure separate the high voltage and low voltage cables, and shorten the wiring lengths, etc.
4. **Do not route input/output wires and cables together with power or high voltage cables.**
The product can malfunction due to interference of noise and surge voltage from power and high voltage cables to the signal line. Route the wires of the product separately from power or high voltage cables.
5. **Take care that actuator movement does not catch cables.**
6. **Operate with all wires and cables secured. Avoid bending cables at sharp angles where they enter the product.**
7. **Avoid twisting, folding, rotating or applying an external force to the cable.**
Risk of electric shock, wire breakage, contact failure and loss of control of the product can happen.
8. **Fix the motor cables protruding from the actuator in place before use.**
The motor and lock cables are not robotic type cables and can be damaged when moved. Therefore fix the cables and the connectors (part "A" in figure below) when set up.

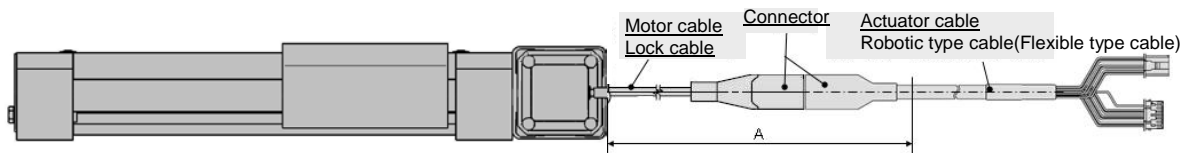

9. **Select "Robotic type cables" in case of inflecting actuator-cable repeatedly. And do not put cables into a flexible moving tube with a radius smaller than the specified value. (Min. 50mm).**

Risk of electric shock, wire break, contact failure and loss of control for the product can happen if "Standard cables" are used in case of inflecting the cables repeatedly

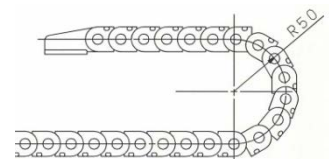

10. **Confirm proper wiring of the product.**

Poor insulation (interference with other circuits, poor insulation between terminals and etc.) can apply excessive voltage or current to the product causing damage.

11. **The Speed / pushing force may vary, depending on the cable length, load and mounting conditions etc.**

If the cable length exceeds 5m, the speed/pushing force will be reduced 10% per 5m as the maximum.(if cable length is 15m: 20% reduction as the maximum.)

[Transportation]

Caution

1. **Do not carry or swing the product by the motor or the cables.**

5. Electric actuators / Common precautions

5.1 Design and selection

Warning

- 1. Be sure to read the operation manual (this manual and the one for the controller: LEC series).**
Handling or usage/operation other than that specified in the Operation Manual may lead to breakage and operation failure of the product.
Any damage attributed to the use beyond the specifications is not guaranteed.
- 2. There is a possibility of dangerous sudden action by the product if sliding parts of machinery are twisted due to external forces etc.**
In such cases, human injury may occur, such as by catching hands or feet in the machinery, or damage to the machinery itself may occur. Design the machinery should be designed to avoid such dangers.
- 3. A protective cover is recommended to minimize the risk of personal injury.**
If a driven object and moving parts of the product are in close proximity, personal injury may occur. Design the system to avoid contact with the human body.
- 4. Securely tighten all stationary parts and connected parts so that they will not become loose.**
When the product operates with high frequency or is installed where there is a lot of vibration, ensure that all parts remain secure.
- 5. Consider a possible loss of power source.**
Take measures to prevent injury and equipment damage even in the case of a power source failure.
- 6. Consider behavior of emergency stop of whole system.**
Design the system so that human injury and/or damage to machinery and equipment will not be caused, when it is stopped by a safety device for abnormal conditions such as a power outage or a manual emergency stop of whole system.
- 7. Consider the action when operation is restarted after an emergency stop or abnormal stop of whole system.**
Design the system so that human injury or equipment damage will not occur upon restart of operation of whole system.
- 8. Never disassemble or modify (including additional machining) the product.**
An injury or failure can result.
It will cause the loss of the product performance.
- 9. Do not use the stop signal, "EMG" of the controller and stop switch on the teaching box as the emergency stop of system.**
The stop signal, "EMG" of controller and the stop switch on the teaching box are for decelerating and stopping the actuator.
Design the system with an emergency stop circuit which is applied relevant safety standard separately.
- 10. When using it for vertical application, it is necessary to build in a safety device.**
The table may fall due to the weight of work. The safety device should not interfere with normal operation of the machine.

Caution

- 1. Operate within the limits of the maximum usable stroke.**
The product will be damaged if it is used with the stroke which is over the maximum stroke. Refer to the specifications of the product.
- 2. When the product repeatedly cycles with partial strokes, operate it at a full stroke at least once a day or every 1000 strokes.**
Otherwise, lubrication can run out.
- 3. Do not use the product in applications where excessive external force or impact force is applied to it.**
The product can be damaged. Each component that includes motor is made with accurate tolerance. So even slightly deformed or miss-alignment of component may lead operation failure of the product.

4. **Returning to origin cannot be done during the operation.**
It cannot be done during positioning operation, pushing operation and pushing.
5. **Refer to a common auto switch /matter (Best Pneumatics No 2) when an auto switch is built in and used.**
6. **When conformity to UL is required, the electric actuator and controller should be used with a UL1310 Class 2 power supply.**

5.2 Mounting

Warning

1. **Install and operate the product only after reading the Operation Manual carefully and understanding its contents. Keep the manual in a safe place for future reference.**
2. **Observe the tightening torque for screws.**
Unless stated otherwise, tighten the screws to the recommended torque for mounting the product.
3. **Do not make any alterations to this product.**
Alterations made to this product may lead to a loss of durability and damage to the product, which can lead to human injury and damage to other equipment and machinery.
4. **When using external guide, the guide axis should be parallel to the actuator axis.**
There will be damage/excessive wear on the lead screw if the external guide is not parallel.
5. **When an external guide is used, connect the moving parts of the product and the load in such a way that there is no interference at any point within the stroke.**
Do not scratch or dent the sliding parts of the table or mounting face etc., by striking or holding them with other objects. The components are manufactured to precise tolerances, so that even a slight deformation may cause faulty operation or seizure.
6. **Prevent the seizure of rotating parts.**
Prevent the seizure of rotating parts (pins, etc.) by applying grease.
7. **Do not use the product until you verify that the equipment can be operated correctly.**
After mounting or repair, connect the power supply to the product and perform appropriate functional inspections to check it is mounted correctly.
8. **Cantilever**
When the actuator is operated at high speed while it is fixed at one end and free at the other end (flange type, foot type, double clevis type, direct mount type), a bending moment may act on the actuator due to vibration generated at the stroke end, which can damage the actuator. In such a case, install a support bracket to suppress the vibration of the actuator body or reduce the speed so that the actuator does not vibrate. Use a support bracket also when moving the actuator body or when a long stroke actuator is mounted horizontally and fixed at one end.
9. **When mounting the actuator or attaching to the work piece, do not apply strong impact or large moment.**
If an external force over the allowable moment is applied, it may cause looseness in the guide unit, an increase in sliding resistance or other problems.
10. **Maintenance space**
Allow sufficient space for maintenance and inspection.

5.3 Handling

Warning

- 1. Do not touch the motor while in operation.**

The surface temperature of the motor can increase to approx. 80°C due to operating conditions. Energizing alone may also cause this temperature increase. As it may cause burns, do not touch the motor when in operation.
- 2. If abnormal heating, smoking or fire, etc. occurs in the product, immediately turn off the power supply.**
- 3. Immediately stop operation if abnormal operation noise or vibration occurs.**

If abnormal operation noise or vibration occurs, the product may have been mounted incorrectly. Unless operation of the product is stopped for inspection, the product can be seriously damaged.
- 4. Never touch the rotating part of the motor or the moving part of the actuator while in operation.**
- 5. When installing, adjusting, inspecting or performing maintenance on the product, controller and related equipment, be sure to turn off the power supply to each of them. Then, lock it so that no one other than the person working can turn the power on, or implement measures such as a safety plug.**

Caution

- 1. Keep the controller and product combined as delivered for use.**

The product is set in parameters for shipment. If it is combined with a different product parameter, failure can result.
- 2. Check the product for the following points before operation.**
 - a) Damage to power supply line and signal line.
 - b) Looseness of the connector to each power line and signal line.
 - c) Looseness of the actuator /cylinder and controller /driver mounting
 - d) Abnormal operation
 - e) Emergency stop of the total system
- 3. When more than one person is performing work, decide on the procedures, signals, measures and resolution for abnormal conditions before beginning the work. Also, designate a person to supervise work other than those performing work.**
- 4. Actual speed of the product will be changed by the workload.**

Before selecting a product, check the catalog for the instructions regarding selection and specifications.
- 5. Do not apply a load, impact or resistance in addition to a transferred load during return to origin.**

In the case of the return to origin by pushing force, additional force will cause displacement of the origin position since it is based on detected motor torque.
- 6. Do not remove the nameplate.**
- 7. Operation test should be performed by low speed. Start operation by predefined speed after confirming there are no problems.**

[Earth]

Warning

- 1. Please give the earth to the actuator.**
- 2. Please make it to the earth of exclusive use. The earth construction is D seed.**

(Below earth resistance 100Ω)
- 3. Please shorten the distance until the actuator and earth.**

[Unpackaging]

Caution

1. Check the received product is as ordered.

If the different product is installed from the one ordered, injury or damage could result.

5.4 Operating environment

Warning

1. Avoid use in the following environments.

- a. Locations where a large amount of dusts and cutting chips are airborne.
- b. Locations where the ambient temperature is outside the range (refer to specifications).
- c. Locations where the ambient humidity is outside the range (refer to specifications).
- d. Locations where corrosive gas, flammable gas, sea water, water and steam are present.
- e. Locations where strong magnetic or electric fields are generated.
- f. Locations where direct vibration or impact is applied to the product.
- g. Areas that are dusty, or are exposed to splashes of water and oil drops.
- h. Areas exposed to direct sunlight (ultraviolet ray).

2. Do not use in an environment where the product is directly exposed to liquid, such as cutting oils.

If cutting oils, coolant or oil mist contaminates the product, failure or increased sliding resistance can result.

3. Install a protective cover when the product is used in an environment directly exposed to foreign matters such as dust, cutting chips and spatter.

Play or increased sliding resistance can result.

4. Shade the sunlight in the place where the product is applied with direct sunshine.

5. Shield the product if there is a heat source nearby.

When there is a heat source surrounding the product, the radiated heat from the heat source can increase the temperature of the product beyond the operating temperature range. Protect it with a cover, etc.

6. Grease oil can be decreased due to external environment and operating conditions and it deteriorates lubrication performance to shorten the life of the product.

[Storage]

Warning

1. Do not store the product in a place in direct contact with rain or water drops or is exposed to harmful gas or liquid.

2. Store in an area that is shaded from direct sunlight and has a temperature and humidity within the specified range (-10°C to 60°C and 90%RH or less No condensation or freezing).

3. Do not apply vibration and impact to the product during storage.

5.5 Maintenance

Warning

- 1. Do not disassemble or repair the product.**
Fire or electric shock can result.
Contact SMC, in case of disassembly for the maintenance.
- 2. Before modifying or checking the wiring, the voltage should be checked with a tester 5 minutes after the power supply is turned off.**
Electrical shock can result.

Caution

- 1. Maintenance should be performed according to the procedure indicated in the Operating Manual.**
Incorrect handling can cause an injury, damage or malfunction of equipment and machinery.
- 2. Removal of product**
When equipment is serviced, first confirm that measures are in place to prevent dropping of work pieces and run-away of equipment, etc, and then cut the power supply to the system. When machinery is restarted, check that operation is normal with actuators in the proper positions.

[Lubrication]

Caution

- 1. The product has been lubricated for life at manufacturer, and does not require lubrication in service.**
Contact SMC if lubrication will be applied.

5.6 Precautions for actuator with lock

Warning

- 1. Do not use the lock as a safety lock or a control that requires a locking force.**
The lock used for the product with a lock is designed to prevent dropping of work piece.
- 2. Do not apply an impact load or strong vibration while the lock is activated.**
If an external impact load or strong vibration is applied to the product, the lock will lose its holding force and damage to the sliding part of the lock or reduced lifetime can result. The same situation will happen when the lock slips due to a force higher than its holding force, as this will accelerate the wear to the lock.
- 3. Do not apply liquid or oil and grease to the lock or its surrounding.**
When liquid or oil and grease are adhered to the sliding part of the lock, its holding force will reduce significantly. Or, lock sliding part performance and condition changes may be cause of lock release malfunction.
- 4. Take “measures against drops” and check that safety is assured before mounting, adjustment and inspection of the product.**
If the lock is released with the product mounted vertically, a work piece can drop due to its weight.
- 5. When the actuator is operated manually (when SVRE output signal is off), supply 24DCV to the [BK RLS] terminal of the power supply connector.**
If the product is operated without releasing the lock, wearing of the lock sliding surface will be accelerated, causing reduction in the holding force and the life of the locking mechanism.
- 6. Do not supply 24VDC power supply constantly to the [BK RLS(Lock release)] terminal.**
Stop supplying 24VDC power supply to the [BK RLS(Lock release) terminal during normal operation. If power is supplied to the [BK RLS] terminal continuously, the lock will be released, and workpieces may be dropped at stop (EMG).
/Refer to the operation manual of LEC (controller) for details of wiring.

6. Electric actuators / Guide rod Slider Common precautions

6.1 Design and selection

Warning

- 1. Do not apply a load in excess of the actuator specification.**

A product should be selected based on the maximum work load and allowable moment.
If the product is used outside of the operating specification, eccentric load applied to the guide will become excessive and have adverse effects such as creating play in the guide, reduced accuracy and reduced product life. And also when "With magnet / switch rail" option is selected, Auto switch may not detect correctly by the deflection of the guide rod.
- 2. Do not exceed the speed limit of the actuator specification.**

Select a suitable actuator by the relationship of allowable work load and speed.
Noise or reduction of accuracy may occur if the actuator is operated in excess of its specification and could lead to reduced accuracy and reduced product file.
- 3. Do not use the product in applications where excessive external force or impact force is applied to it.**

This can lead to premature failure of the product.
- 4. Do not apply excessive external force or impact force to the motor.**

Miss-alignment of the motor may lead to signal detection error, increasing internal friction or damage to the motor.
- 5. When external force is applied to the table, it is necessary to add the external force to the workload as the total carried load for the sizing.**

When mounting cable duct and so on in parallel to the actuator, it is necessary to add the friction to the workload as the total carried load for the sizing too.
- 6. Because of the guide mechanism type, vibration that comes from an external source may be introduced into the work-piece during operation.**

Do not use this product in a location where vibration is not allowed.

6.2 Handling

Caution

- 1. INP output signal**
 - 1) Positioning operation**

When the product comes within the set range by step data [In position], output signal will be turned on. Set to [1] or higher for LEL.
- 2. Do not change the positioning force from initial setting.**

If the positioning force is changed, it may cause a decrease in performance.
- 3. Do not operate by fixing the table and moving the actuator body.**

An excessive load will be applied to the table, which could lead to damage to the actuator and reduced accuracy and reduced product life.
- 4. This actuator cannot be used for vertically mounted applications.**
- 5. Check the specification for the minimum speed of each actuator.**
- 6. In the case of the belt driven actuator, vibration may occur during operation at speeds within the actuator specification, this could be caused by the operating conditions. Change the speed setting to a speed that does not cause vibration.**

6.3 Mounting

⚠ Caution

- 1. Ensure flatness of the mounting surface to within 0.2mm or less.**
Insufficient flatness of the work piece or the surface onto which the actuator body is to be mounted can cause play in the guide and increased sliding resistance.
- 2. When mounting the workpiece or other device to the actuator tighten the fixing screws with adequate torque within the specified torque range.**
Tightening the screws with a higher torque than the maximum may cause malfunction, whilst tightening with a lower torque can cause the displacement of the mounting position or in extreme conditions detaching of the work piece.

Work piece mounting

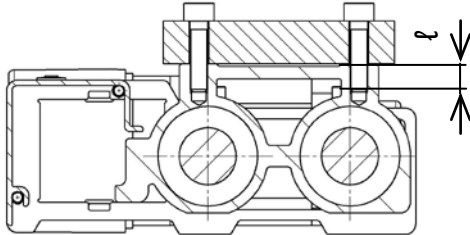

Model	Bolt size	Maximum tightening torque [Nm]	ℓ (Maximum thread depth [mm])
LEL25*	M5x0.8	3.0	8

Use screws with adequate length, but with length less than the maximum thread depth. The use of screws that are too long can touch the body and cause malfunction.

- 3. When mounting the actuator, use screws with adequate length and tighten them to the adequate torque. And use all mounting holes to maintain the catalogue performance.**
Tightening the screws with a higher torque than recommended may cause malfunction, whilst the tightening with lower torque can cause the displacement of mounting position or in extreme conditions the actuator could become detached from its mounting position.

Actuator mounting

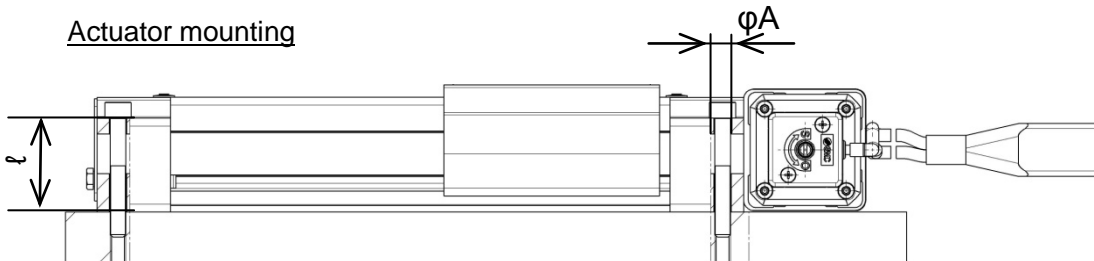

Model	Bolt size	Maximum tightening torque [Nm]	φA (mm)	ℓ (mm)
LEL25□	M6	5.2	6.6	35.5

- 4. When mounting the actuator, leave a gap of 40mm or more to allow for bending of the actuator cable.**

6.4 Precaution on maintenance

Warning

1. Turn off the power supply before maintenance and replacement of the product.
2. Put on protective goggles when applying grease.

[Maintenance frequency]

Perform maintenance according to the table below. Contact SMC if any abnormality is found.

Frequency	Appearance check	Internal check	Belt check
Inspection before daily operation	○	/	/
Inspection every six months / 1000km / 5million cycle *	○	○	○

*Whichever occurs first.

[Items for visual appearance check]

1. Loose screws. Abnormal dirt.
2. Check of flaws/faults and cable connections.
3. Vibration, noise.

[Items for internal check]

1. Lubricant condition on moving parts.
2. Loose or mechanical play in fixed parts or fixing screws.

[Items for belt check]

Check the belt regularly as shown in “maintenance frequency”.

Stop operation immediately and contact SMC when the belt appears to be like photographs shown below.

a. Tooth shape canvas is worn out

Canvas fiber becomes fuzzy.
Rubber is removed and the fiber becomes whitish.
Lines of fibers become unclear.

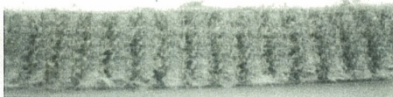

Teeth become fuzzy

b. Peeling off or wearing of the side of the belt

Belt corner becomes round and frayed thread sticks out.



c. Belt partially cut

Belt is partially cut. Foreign matter caught in teeth other than cut part causes flaw.

d. Vertical line of belt teeth

Flaw, which is made when the belt runs on the flange.

e. Rubber back of the belt is softened and sticky.

f. Crack on the back of the belt

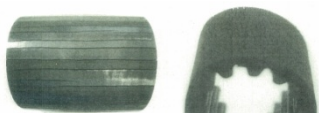

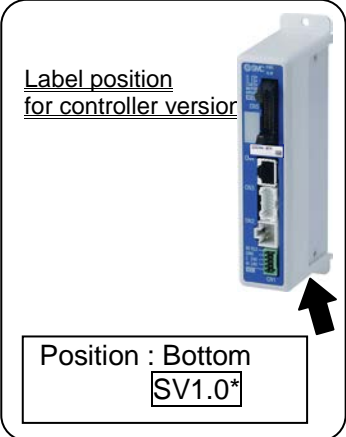
No.	Phenomenon	Cause	Countermeasure
2	<p>Operation not completed / Operation continue</p> <p>Alarm for "Over load/code: 1-148" or "Posn failed/code: 1-149" is generated.</p> <p style="text-align: center;">↓</p> <p style="text-align: center;"><Procedure of restart> Controller version /SV1.0 or later 1. Input the "reset signal." →"SVRE": Automatically ON</p> <p>Controller version /SV0.8* or before 1. Input the "reset signal." →"SVRE": Automatically ON 2. Input the "setup signal." → Restart operation after the completion of the"return to origin".</p> <div style="border: 1px solid black; padding: 5px; margin: 10px 0;"> <p><u>Label position for controller versior</u></p>  <p>Position : Bottom SV1.0*</p> </div>	1) Added excessive external force (including vibration) or impact load.	Operate within the specified range. /See 2.1 Specifications on page 9
		2) The Power supply does not have sufficient capacity.	Check the power consumption for each actuator and controller: If necessary replace the existing power supply with a power supply with sufficient capacity. /See 2.1 Specifications on page 9
		3) Load/resistance more than specified range is being applied to the actuator.	Use within specification range. Check the actuator mounting condition or check if external force adds the resistance of actuator table by using movable cable-duct. /See 2.1 Specifications on page 9
		4) Pushing operation is performed at "Positioning operation"	Review the content of the step data.
		5) The cable is not connected or has been disconnected.	Confirm that the cable is connected correctly. /See 4. Wiring of cable on page 26
		6) It was not the intended origin position because the actuator pinched the work-piece during the"return to origin".	Remove the work-piece and restart the return to the intended origin position.
		7) Actuator mouting condition is not good.	Check the actuator mounting surface. Keep the flatness of mounting surace to within 0.2mm or less.
		8) Wrong input [0] is input as the positioning force.	Check the step data.<Moving force> /See 3.3.Step data setting method on page 17
		9) The step data position is not changed correctly after the return to origin direction is changed.	Check the step data.<Position> /See 3.3.Step data setting method on page 17
		10) Because the operation of the step data is set to [INC/relative], the table comes into contact with an external object and does not move due to continuous operation.	Check the step data.<Position> /See 3.3.Step data setting method on page 17
1	<p>Operation not completed / Operation continue</p> <p>Alarm for "Stroke limit/code: 1-052" is generated.</p> <p style="text-align: center;">↓</p> <p style="text-align: center;"><Procedure of restart> Input the "RESET" signal.</p>	1) Moving distance exceeds the "Stroke (+)" / "Stroke (-).	1) Check the value of the "Position" of step data and the value of the "Stroke (+)" / "Stroke (-)" of the basic parameter. /See 3.3.Step data setting method on page 17 3.4.Parametertrting o sen page 23 /Refer to the LEC controller operation manual.

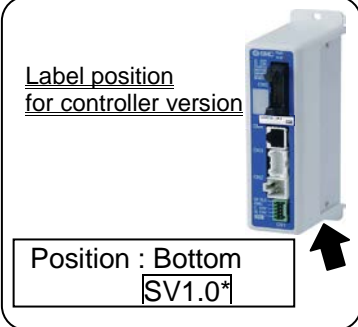
No.	Phenomenon	Cause	Countermeasure	
2	Operation not completed / Operation continue Alarm for "Over motor Vol /code: 1-145" is generated. ↓ <Procedure of restart> Controller version /SV1.0 or later 1. Input the "reset signal." →"SVRE": Automatically ON Controller version /SV0.8* or before 1. Input the "reset signal." →"SVRE": Automatically ON 2. Input the "setup signal." →Restart operation after the completion of the "return to origin"	1) If the power supply is an "inrush-current restraining type", the alarm may be generated due to voltage drop.	Replace the power supply with a non "inrush-current restraining type" power supply. / Refer to the LEC controller operation manual.	
		2) The Power supply does not have sufficient capacity.	Check the power consumption for each actuator and controller: If necessary replace the existing power supply with a power supply with sufficient capacity. /See 2.1 Specifications on page 9	
		3) Load/resistance more than specified range is being applied to the actuator.	Use within specification range. Check the actuator mounting condition or check if external force adds the resistance of actuator table by using movable cable-duct. /See 2.1 Specifications on page 9	
	<div style="border: 1px solid black; padding: 5px; width: fit-content;"> <p><u>Label position for controller version</u></p>  <p>Position : Bottom SV1.0*</p> </div>	Alarm for "Err overflow/code: 1-196" is generated. ↓ <Procedure of restart> "Turn the power supply off." ↓ "Turn the power supply on"	1) Added excessive external force (including vibration) or impact load.	Operate within the specified range. /See 2.1 Specifications on page 9
	2) The Power supply does not have sufficient capacity.	Check the power consumption for each actuator and controller: If necessary replace the existing power supply with a power supply with sufficient capacity. /See 2.1 Specifications on page 9		
3) Load/resistance more than specified range is being applied to the actuator.	Use within specification range. /See 2.1 Specifications on page 9 Check the actuator mounting condition or check if external force adds the resistance of actuator table by using movable cable-duct.			
4) The pushing operation is performed at the "Positioning operation position"	Review the content of the step data.			
5) The cable is not connected or has been disconnected.	Confirm that the cable is connected correctly. /See 4. Wiring of cable on page 26			

No.	Phenomenon	Cause	Countermeasure
2		6) It was not the intended origin position because the actuator pinched the work-piece during the "return to origin".	Remove the work-piece and restart the return to the intended origin position.
		7) Wrong input [0] is input as the positioning force.	Check the step data.<Moving force> /See 3.3.Step data setting method on page 17
		8) The step data position is not changed correctly after the return to origin direction is changed.	Check the step data <Position>. /See 3.3.Step data setting method on page 17
		9) Because the operation of the step data is set to [INC/relative], the table comes into contact with an external object and does not move due to continuous operation.	Check the step data <Position>. /See 3.3 Step data setting method on page 17
		10) Actuator mounting condition is not good.	Check the actuator mounting surface. Keep the flatness of mounting surface to within 0.2mm or less.
Operation not completed / During operation (Not always, but may happen occasionally) Alarm for "Step data ALM2/code: 1-051" is generated. ↓ <Procedure of restart> Input the "reset" signal.	1) Command invalid (unregistered) step data.	Check if the step data is valid (registered).	
	2) Different input signal to the expected step number is inputted to the controller, because of a too short an interval between the input signal of "IN*" and the "Drive" or inputting the signals at the same time.	Add an interval of 15ms (the recommendation is 30ms) or more between the input signals. / See "Operating procedure input / output signals for each operation type" on page 21	
	3) Different input signal to the expected step number is inputted to the controller, because the input signal time was too short.	Add an interval of 15ms (the recommendation is 30ms) or more between the input signals. / See "Operating procedure input / output signals for each operation type" on page 21	
	4) Different input signal to the expected step number is inputted to the controller, caused by PLC or other device.	Check that the step number is inputted correctly for the required motion.	
- Operation completed by unexpected motion. - No alarm / During operation (Not always, but may happen occasionally)	1) Different input signal to the expected step number is inputted to the controller, because of a too short an interval between the input signal of the "IN*" and the "Drive" or inputting the signals at the same time.	Add an interval of 15ms (the recommendation is 30ms) or more between the input signals. / See "Operating procedure input / output signals for each operation type" on page 21 Note) Recommend to check the "OUT" output signal for more secure operation.	
	2) Different input signal to the expected step number is inputted to the controller, because the input signal time was too short.	Add an interval of 15ms (the recommendation is 30ms) or more between the input signals. / See "Operating procedure input / output signals for each operation type" on page 21 Note) Recommend to check the "OUT" output signal for more secure operation.	
	3) Different input signal to the expected step number is inputted to the controller, caused by PLC or other device.	Check that the step number is inputted correctly for the required motion. / See "Operating procedure input / output signals for each operation type" on page 21 Note) Recommend to check the "OUT" output signal for more secure operation.	

No.	Phenomenon	Cause	Countermeasure
3	"INP" output signal is unstable. "INP" output signal is unstable even after the positioning operation is completed.	1) The value of [In position] in step data is too small.	Increase [In position] value as the following. LEL : [1] or more
4	Positioning repeatability is out of specified range.	1) It shifts to the next operation by receiving the "INP" output signal.	Shift to the next operation after receiving the "BUSY" output signal is outputted.
		2) The belt is loosened.	Readjust belt tension to the appropriated value.
5	Damage	1) Abnormal external force	Interference of mechanism, eccentric load or excess load leads to cause deformation or damage of the actuator. Eliminate these factors.
6	The table of the actuator with vertical mounting vibrates repeated up and down.	1) Actuator is used vertically.	Actuator cannot be used vertically. Use actuator for horizontal and wall mounting only.
7	The belt driven actuator, vibration / noise occur during operation at speeds within the actuator specification.	1) Influence of character frequency	Change the speed setting to a speed that does not cause vibration.
		2) The gain tuning is not suitable.	It may need gain tuning suitable for the application. Contact SMC in this case.
8	Cannot be actuated manually or by manual override adjustment screw (does not operate). (At stop(EMG) or SVRE[OFF])	1) Contacts the stroke end of the actuator or the workpiece.	Check the stroke position and how workpieces are mounted.
		2) [Lock type] is selected	Supply 24VDC power supply to the [BK RLS] terminal of controller/CN1 power supply plug in order to unlock. /see 5.6 Precautions for the actuator with lock  Warning(5) on page 30
	Lock type is selected, but workpieces are dropped during stopping(EMG) or SVRE[OFF], or moved by external force.	1) Load exceeding the maximum work load is mounted, or external force more than the lock holding force is applied. 2) 24VDC is supplied to "BK RLS" terminal of controller/CN1 power supply connector.	Check the mounted load and lock holding force to confirm if they are within the operation range. /See 2.1 Specifications on page 9 Stop supplying 24VDC power supply to the [BK RLS] terminal /see 5.6 Precautions for the actuator with lock  Warning(6) on page 30

Revision history

No.LEL-OM00201

Oct / 2011 : 1st printing

No.LEL-OM00202

Apr / 2012 : Revision

No.LEL-OM00203

Mar. /2016: Revision

No.LEL-OM00204

Apr. /2016: Revision

SMC Corporation

4-14-1, Sotokanda, Chiyoda-ku, Tokyo 101-0021 JAPAN

Tel: + 81 3 5207 8249 Fax: +81 3 5298 5362

URL <http://www.smcworld.com>