



Operation Manual

Installation · Operation

Original Instructions Thermo-chiller

<i>HRR012-A-10-*</i>	(€	<i>HRR012-W-10-*</i>	(€
<i>HRR018-A-10-*</i>	(€	<i>HRR018-W-10-*</i>	(€
<i>HRR012-A-20-*</i>	(€	<i>HRR012-W-20-*</i>	(€
<i>HRR018-A-20-*</i>	(€	<i>HRR018-W-20-*</i>	(€
<i>HRR024-A-20-*</i>	(€	<i>HRR024-W-20-*</i>	(€
<i>HRR030-A-20-*</i>	(€	<i>HRR030-W-20-*</i>	(€

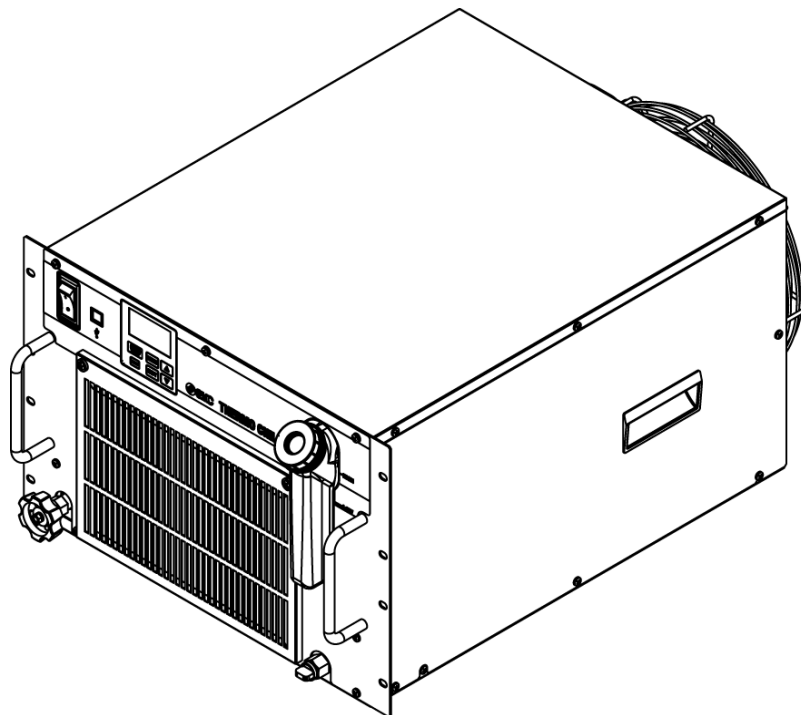

Keep this manual available whenever necessary

To the users

Thank you for purchasing SMC's Thermo chiller (hereinafter referred to as the "product").

For safety and long life of the product, be sure to read this operation manual (hereinafter referred to as the "manual") and clearly understand the contents.

- Be sure to read and follow all instructions noted with "Warning" or "Caution" in this manual.
- This manual is intended to explain the installation and operation of the product. Only people who understand the basic operation of the product through this manual or who perform installation and operation of or have basic knowledge about industrial machines are allowed to work on the product.
- This manual and other documents attached to the product do not constitute a contract, and will not affect any existing agreements or commitments.
- It is strictly prohibited to copy this manual entirely or partially for the use by a third party without prior permission from SMC.

Note: This manual is subject to possible change without prior notice.

Contents

Chapter 1	Safety Instructions	1-1
1.1	Before using the product	1-1
1.2	Reading the Manual	1-1
1.3	Hazards	1-2
1.3.1	Level of hazards	1-2
1.3.2	Definition of "Serious injury" and "Minor injury"	1-2
1.4	Product Label	1-3
1.5	Safety Measures	1-4
1.5.1	Safety instructions for use	1-4
1.5.2	Personal protective equipment	1-4
1.6	Emergency Measures	1-5
1.7	Waste Disposal	1-6
1.7.1	Disposal of refrigerant and compressor oil	1-6
1.7.2	Disposal of product	1-6
1.8	Material Safety Data Sheet (MSDS)	1-7
Chapter 2	Name and Function of Parts	2-1
2.1	Model Number of Product	2-1
2.1.1	Air-cooled refrigerator type	2-1
2.1.2	Water-cooled refrigerator type	2-2
2.2	Name and Function of Parts	2-3
2.2.1	HRR012/018/024/030-A-10/20-* (Air cooled type)	2-3
2.2.2	HRR012/018/024/030-W-10/20-*U (Water cooled type)	2-4
2.3	Function of Parts	2-5
2.4	Operation display panel	2-6
Chapter 3	Transport and Setting Up	3-1
3.1	Transport	3-1
3.2	Installation	3-2
3.2.1	Environment	3-2
3.2.2	Location	3-4
3.2.3	Installation and Maintenance Space	3-6
3.3	Installation	3-7
3.3.1	Mounting	3-7
3.3.2	Electrical wiring	3-8
3.3.3	Preparation and wiring of power supply cable	3-10
3.3.4	Contact input/output communication wiring	3-12
3.3.5	Wiring of run/stop signal input and remote signal input	3-14
3.3.6	Wiring of contact output signal	3-15
3.3.7	RS-485 communication wiring	3-16
3.3.8	RS-232C communication wiring	3-18
3.4	Piping	3-19
3.5	Fill of circulating fluid	3-23

Chapter 4	Starting the Product	4-1
4.1	Before Starting	4-1
4.2	Starting and Stopping	4-2
4.2.1	Operation	4-2
4.2.2	Operation restart when alarm is generated	4-3
4.2.3	Stopping the product	4-5
4.3	Adjustment of bypass valve	4-6
4.4	Check items after starting	4-6
Chapter 5	Display and Setting of Various Functions	5-1
5.1	List of Functions	5-1
5.2	Function	5-2
5.2.1	Key operations	5-2
5.3	List of parameters	5-6
5.3.1	Main Menu	5-6
5.3.2	Alarm display menu	5-6
5.3.3	Notice for maintenance Menu	5-6
5.3.4	Monitor Menu	5-7
5.3.5	Standard setting menu	5-8
5.3.6	Alarm Setting Menu	5-9
5.3.7	Communication setting menu	5-10
5.3.8	Reset menu	5-11
5.3.9	Information Monitor Setting Menu	5-11
5.4	Basic setting mode	5-12
5.4.1	Screen configuration	5-12
5.4.2	Main menu	5-12
5.4.3	Alarm display menu	5-14
5.4.4	Notice for maintenance Menu	5-15
5.5	Advanced setting mode	5-17
5.5.1	Switch to advanced setting mode	5-17
5.5.2	Display contents of monitor menu	5-17
5.5.3	Display contents of the standard setting menu	5-19
5.5.4	Alarm setting menu	5-33
5.5.5	Communication setting menu	5-46
5.5.6	Reset menu	5-54
5.5.7	Information Monitor Menu	5-58
5.5.8	Alarm History menu	5-62
Chapter 6	Option	6-1
6.1	Option DM 【Electric conductivity control function , DI water (pure water) piping】	6-1
6.1.1	Option DM【Electric conductivity control function , DI water (pure water) piping】	6-1
6.2	Option M 【DI water (Pure water) piping】	6-2
6.2.1	Option M【DI water (Pure water) piping】	6-2
6.3	Option T 【High-pressure pump mounted】	6-2

6.3.1	Option T【High-pressure pump mounted】	6-2
6.4	Option T1 【Inverter pump mounted】	6-3
6.5	Option Y 【With feet and no Rack Mounting bracket】	6-4
6.5.1	Option Y【With feet and no Rack Mounting bracket】	6-4
6.5.2	Anti-quake bracket (Optional Accessories)	6-5
6.6	Option Z 【Removed Parts】	6-6
6.6.1	Option Z【Removed Parts】	6-6
Chapter 7	Alarm Notification and Troubleshooting	7-1
7.1	Alarm Notification	7-1
7.2	Alarm Buzzer Stop	7-3
7.3	Troubleshooting	7-4
7.3.1	Alarm contents, causes, and troubleshooting	7-4
7.4	Other Errors	7-6
Chapter 8	Control, Inspection, Exchange and Cleaning	8-1
8.1	Quality Control of Circulating Fluid and Facility Water	8-1
8.2	Inspection, exchange, cleaning	8-2
8.2.1	Daily check	8-2
8.2.2	Monthly check	8-4
8.2.3	Inspection every 3 months	8-5
8.2.4	Inspection every 6 months	8-8
8.3	Stop for a Long Time	8-9
8.3.1	Discharge of the circulating fluid	8-9
8.3.2	Discharge of the facility water (Water-cooled type)	8-12
8.4	Replacement of consumables	8-14
8.4.1	Replacing Particle Filters	8-14
8.4.2	Replacing the DI filter (Option DM)	8-14
8.5	Electrical schematic diagram	8-16
Chapter 9	Documents	9-1
9.1	Specifications	9-1
9.1.1	HRR012/018/024/030-A-10/20-*	9-1
9.1.2	HRR012/018/024/030-W-10/20-*	9-3
9.1.3	Refrigerant with GWP reference	9-5
9.1.4	Communication specification	9-5
9.2	Outline dimensions	9-6
9.2.1	HRR012/018-A-10/20-*	9-6
9.2.2	HRR012/018-W-10/20-*	9-7
9.2.3	HRR024/030-A-20-*	9-8
9.2.4	HRR024/030-W-20-*	9-9
9.3	Flow Chart	9-10
9.3.1	HRR012/018/024/030-A-10/20-*	9-10
9.3.2	HRR012/018/024/030-W-10/20-*	9-10
9.4	Cooling capacity	9-11
9.4.1	HRR012-A/W-10/20-*	9-11

9.4.2	HRR018-A/W-10/20-*	9-11
9.4.3	HRR024-A/W-20-*	9-12
9.4.4	HRR030-A/W-20-*	9-12
9.5	Heating capacity	9-13
9.5.1	HRR012-A/W-10-*,HRR018-A/W-10-*	9-13
9.5.2	HRR012-A/W-20,HRR018-A/W-20	9-13
9.5.3	HRR024-A/W-20,HRR030-A/W-20	9-13
9.6	Pump capacity	9-14
9.6.1	HRR012/018/024/030-A/W-*	9-14
9.6.2	HRR012/018-A/W-10-T/MT	9-14
9.6.3	HRR012/018/024/030-A/W-20-T	9-15
9.6.4	HRR012/018/024/030-A/W-20-MT	9-15
9.6.5	HRR012/018/024/030-A/W-20-T1	9-16
9.7	Required facility water flow (for water-cooled type)	9-17
9.8	Types of Hazard Labels	9-18
9.8.1	Locations of Hazard Labels	9-18
9.9	Daily Check	9-19
Chapter 10	Product Warranty	10-1

Chapter 1 Safety Instructions



Before using the product, be sure to read and understand all the important actions highlighted in this manual.

1.1 Before using the product

- This chapter is intended to specifically describe the safety related issues for handling the product. Read this before handling the product.
- The product is a cooling device using circulating fluid. SMC does not take any responsibility for any problems that may arise from using the product for other purposes.
- This product is for indoor use only and not to be used outdoors
- This product is not designed for a clean room. It generates dust from the internal components such as pump and fan motor.
- The product is operated at high voltage and contains components which become hot and rotate. If a component needs to be replaced or repaired, contact a specialized vendor for parts and service.
- All personnel who work with or around the product should read and understand the safety related information in this manual carefully before starting work.
- The safety manager is responsible for strictly observing safety standards, but responsibility in respect to safety standards during daily work resides with each individual operator and maintenance personnel.
- Do not use the materials that rust or corrode for the circulating fluid and facility water circuits. Using the materials that tend to rust or corrode may cause clogs or/and leakages of the circulating fluid and facility water circuits. In case of using these kind of materials, consider and carry out some prevention against the rusting or corrosion on the customer side.
- This manual must be kept available to operators whenever necessary.

1.2 Reading the Manual

This manual contains symbols to help identify important actions when installing, operating or maintaining the product.



This sign indicates actions that must be followed.



This sign indicates prohibited actions.

1.3 Hazards

1.3.1 Level of hazards

The instructions given in this manual aim to assure the safe and correct operation of the product, and to prevent injury of operators or damage to the product. These instructions are grouped into three categories, Danger, Warning and Caution, which indicate the level of hazard, damage and also the degree of emergency. All safety critical information should be carefully observed at all times.

“DANGER”, “WARNING” and “CAUTION” signs are in order according to severity (DANGER> WARNING> CAUTION).

DANGER

“DANGER”: Hazard that **WILL** cause serious personal injury or death during operation.

WARNING

“WARNING”: Hazard that **MAY** cause serious personal injury or death during operation.

CAUTION

“CAUTION”: Hazard that **MAY** cause minor personal injury.

CAUTION

“CAUTION without exclamation symbol”: Hazard that **MAY** cause damage or failure of the product, facility, devices, etc.

1.3.2 Definition of “Serious injury” and “Minor injury”

■ “Serious injury”

This term describes injuries that result in after effects including loss of eyesight, burns, electric shock, fracture, poisoning, etc. and requires long-term treatment or hospitalization.

■ “Minor injury”

This term describes injuries that do not need long-term treatment or hospitalization. (Others excluded from “Serious injury”.)

1.4 Product Label

Information about the product, such as Serial No. and Model No. can be found on the product label. This information is needed when contacting an SMC sales distributor.

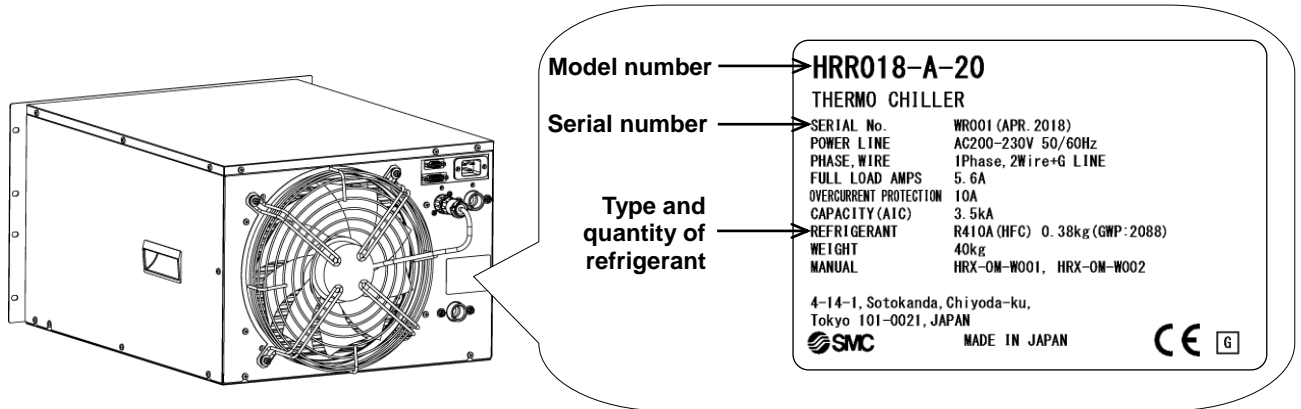

How to read the serial number A R 001 (April 2022)

A			R			001
Year	Symbol	Remarks	Month	Symbol	Remarks	Serial no.
2022	A	Repeat ed from A to Z in alphab etical order	4	R	Repeated from O to Z in alphabetical order, with O for January and Z for December	—
2023	B		5	S		
2024	C		6	T		
↓	↓		↓	↓		

Fig 1-1 Position of product label

1.5 Safety Measures

1.5.1 Safety instructions for use

⚠ WARNING

 **Follow the instructions below when using the product. Failure to follow the instructions may cause an accident and injury.**

- Read and understand this manual carefully before using the product.
- Before starting maintenance of the product, be sure to lock out and tag out the breaker of the user's power supply.
- If operating the product during maintenance, be sure to inform all workers nearby.
- Use only the correct tools and procedure when installing or maintaining the product.
- Use personal protective equipment where specified ("1.5.2 Personal protective equipment").
- Check all parts and screws are fitted correctly and securely after maintenance.
- Avoid working in a drunken or sick condition, which might cause an accident.
- Do not remove the panels except for the cases permitted in this manual.
- Do not remove the panels during operation.
- Do not handle this product by any means other than specified in this Operation Manual; this can result in damage to the product or fire.

1.5.2 Personal protective equipment

This manual specifies personal protective equipment for each type of work.

■ Transport, Installing and Uninstalling

⚠ CAUTION

 **Always use safety shoes, gloves and head protection when transporting, installing or uninstalling the product.**

■ Handling of circulating fluid

⚠ CAUTION

 **Always use safety shoes, gloves, mask, apron and eye protection when handling the circulating fluid.**

■ Operation

⚠ CAUTION

 **Always use safety shoes and gloves when operating the product.**

1.6 Emergency Measures

When emergency conditions such as natural disaster, fire and earthquake, or injury occurs, turn off the power supply switch. After that, be sure to shut off the breaker of the original power supply (customer's power supply equipment).

WARNING



Even when the power supply switch is turned off, some of the internal circuits are still energized, unless the user's power supply is shut off. Be sure to shut off the breaker of the user's power supply.

1. Turn off the power supply switch on the front of the product to stop the operation of the thermo-chiller.

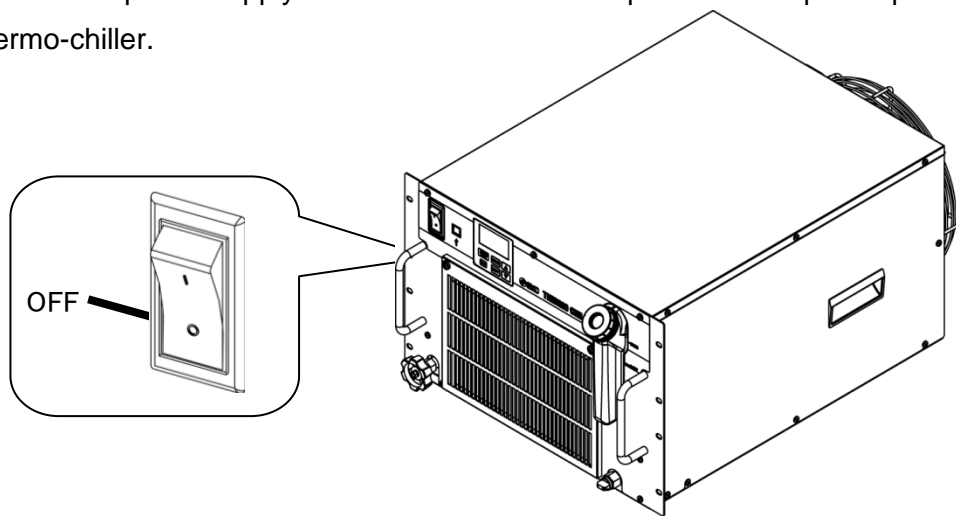

Fig 1-2 Location of the switch for the power supply

2. Be sure to shut off the breaker of the facility power supply (the power supply of the user's machine).

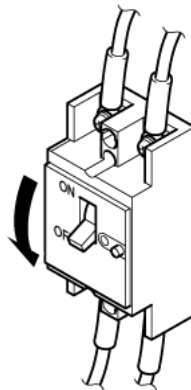

Fig 1-3 Shut off of facility power supply

1.7 Waste Disposal

1.7.1 Disposal of refrigerant and compressor oil

The product uses hydro fluorocarbon type refrigerant (HFC) and compressor oil. Comply with the laws and regulations in each country for the disposal of refrigerant and compressor oil. The type and quantity of refrigerant is described on the "1.4 Product Label".

If these fluids need to be recovered, read and understand the instructions below carefully. If there is any unclear point, contact an SMC's sales distributor.

WARNING



- Only maintenance personnel or qualified people are allowed to open the cover panels of the product.
- Do not mix the compressor oil with domestic waste for disposal. Also, the disposal of the waste must only be conducted by specific facilities that are permitted for that purpose.

WARNING



- Comply with the laws and regulations in each country for the disposal of refrigerant and compressor oil.
- The release of refrigerant in to the atmosphere is banned by law. Recover it with specific equipment and dispose of it correctly.
- Only people who have sufficient knowledge and experience about the product and its accessories are allowed to recover the refrigerant and compressor oil.

1.7.2 Disposal of product

The disposal of the product must be handled by a specialized industrial waste disposal agency in accordance with local laws and regulations.

1.8 Material Safety Data Sheet (MSDS)

If the material safety data sheets of chemicals used in this product are needed, contact an SMC's sales distributor.

Any chemicals used by the user must be accompanied by an MSDS.

Chapter 2 Name and Function of Parts

2.1 Model Number of Product

The product can be ordered with the model number configured as shown below.

The product needs to be handled in different ways depending on the part number. Refer to "1.4 Product Label" and check the part number of the product.

2.1.1 Air-cooled refrigerator type

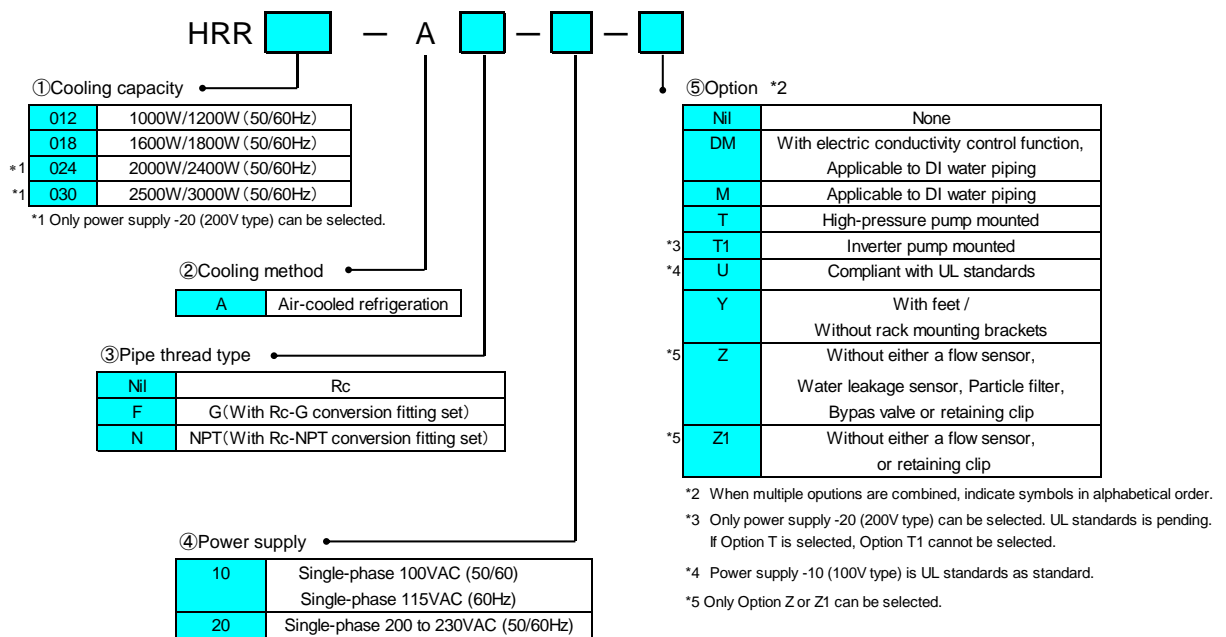

Fig 2-1 Part number of product (1/2)

2.1.2 Water-cooled refrigerator type

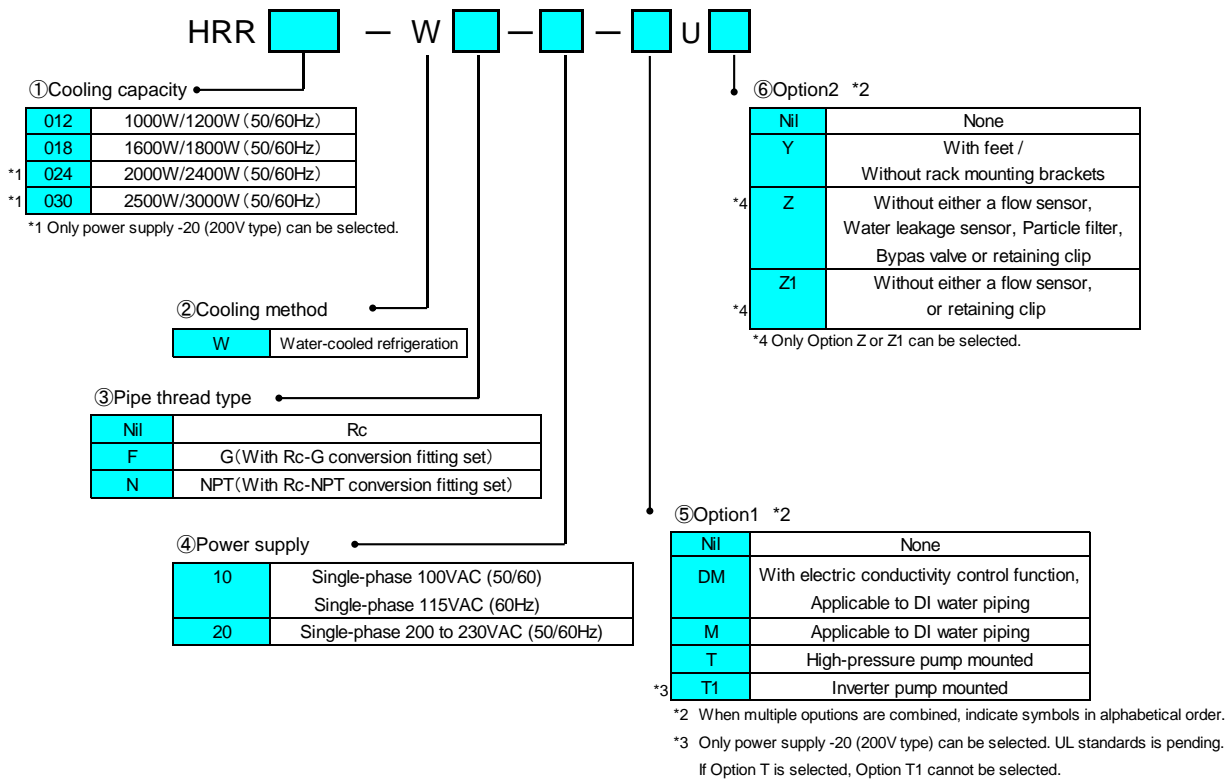
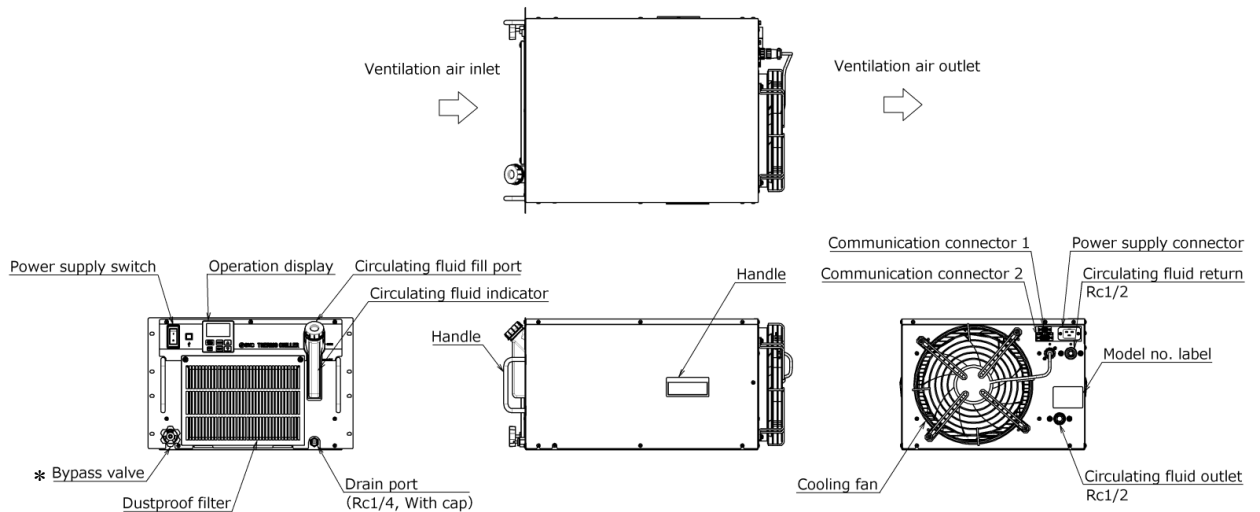

Fig 2-2 Part number of product (2/2)

2.2 Name and Function of Parts



2.2.1 HRR012/018/024/030-A-10/20-* (Air cooled type)



*In the case of option Z, without bypass valve

Fig 2-3 Names of the parts

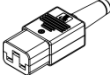
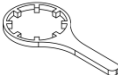
Table 2-1 Accessory list

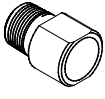
①	Operation manual	2 copies (English 1 copy/ Japanese 1 copy)	
②	Power supply connector	1 pc.	
③	Maintenance handle for particle filter *1 *Use this handle only to loosen the case. Do not use to tighten the case.	1 pc.	
④	Particle filter element *1	1 pc.	
⑤	For option DM DI filter	1 pc.	
⑥	For HRR012/018/024/030-AF-10/20-* G thread adapter set	1 set	
	For HRR012/018/024/030-AN-10/20-* NPT thread adapter set	1 set	

*1 In the case of option Z, not included.

2.2.2 HRR012/018/024/030-W-10/20-*U(Water cooled type)

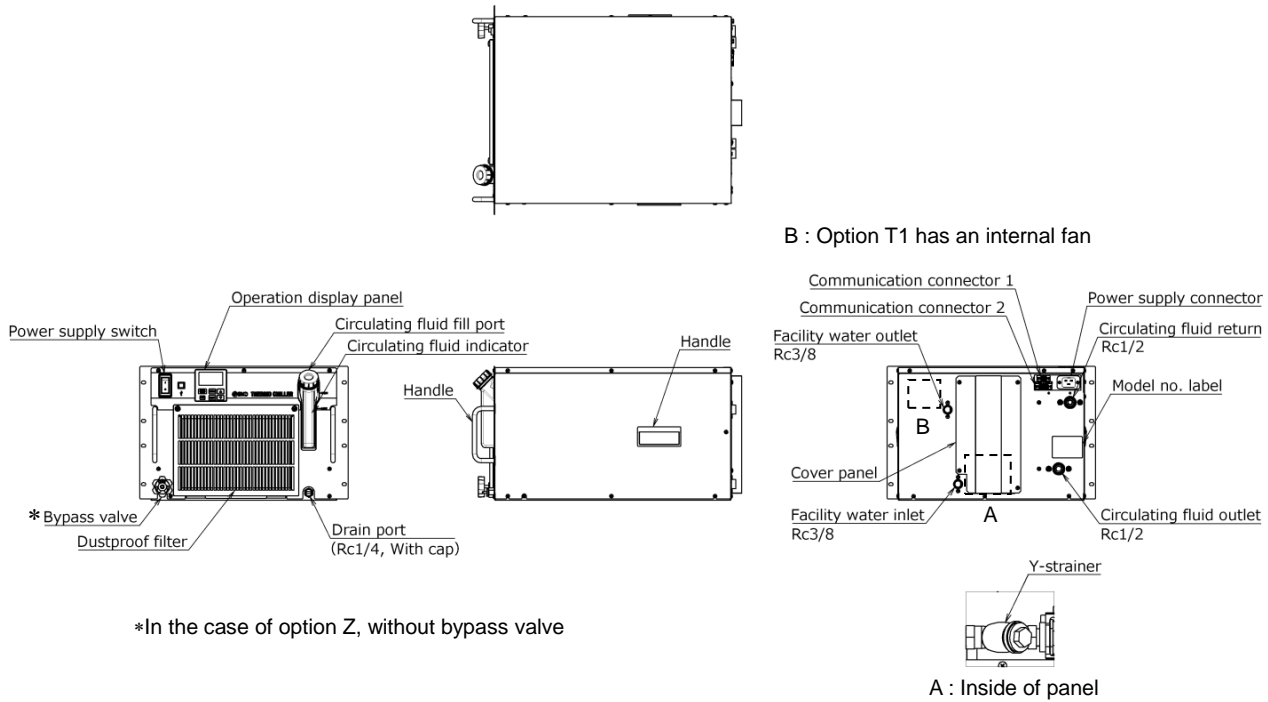

Fig 2-4 Names of the parts

Table 2-2 Accessory list

①	Operation manual	2 copies (English 1 copy/ Japanese 1 copy)	
②	Power supply connector	1 pc.	
③	Maintenance handle for particle filter *1 *Use this handle only to loosen the case. Do not use to tighten the case.	1 pc.	
④	Particle filter element *1	1 pc.	
⑤	For option DM DI filter	1 pc.	
⑥	For HRR012/018/024/030-WF-10/20-* G thread adapter set	1 set	
	For HRR012/018/024/030-WN-10/20-* NPT thread adapter set	1 set	

*1 In the case of option Z, not included.

2.3 Function of Parts

The function of parts is as follows

Table 2-3 Function of parts

Name	Name
Operation display panel	Runs and stops the product and performs settings such as the circulating fluid temperature. For details, refer to "2.4 Operation display panel".
Fluid level gauge	Indicates the circulating fluid level of the tank. For details, refer to "3.5 Fill of circulating fluid".
Power supply switch	Shuts off the power supply to the internal equipment of product.
Model label	Shows the part number of the product. For details, refer to "1.4 Product Label".
Circulating fluid outlet port	The circulating fluid flows out from the outlet port.
Circulating fluid return port	The circulating fluid returns to the return port.
Drain port	Port to drain the circulating fluid out of the tank.
Power supply connector	Connect the power cable to the Power supply connector accessory, and then plug it in. For details, refer to "3.3.3 Preparation and wiring of power supply cable".
Communication connector CN1,CN2	Use for contact input / output, serial communication. For details, refer to "3.3.3 Preparation and wiring of power supply cable".
Facility water inlet (For water-cooled type)	A facility water inlet to which the facility water is fed through piping. The pressure of facility water should be in a range of 0.3 to 0.5MPa.
Facility water outlet (For water-cooled type)	A facility water outlet from which the facility water returns to the user's machine through piping.

2.4 Operation display panel

The operation panel on the front of the product controls the basic operation of the product

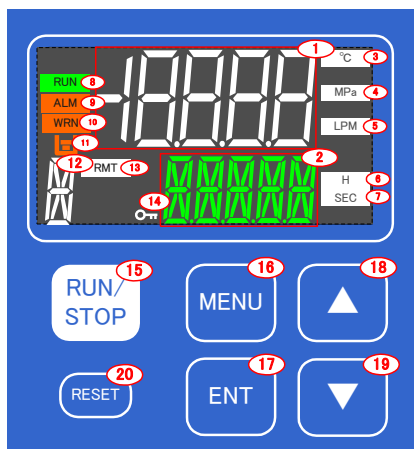

Table 2-4 Operation display panel

No	Name	Function	Reference page
①	Digital display (7 segment, 5 digits)	Displays the temperature, pressure and flow rate of the circulating fluid and the set values of other menus.	5.2
②	Digital display (11 segment, 5 digits)	Displays the discharge temperature of the circulating fluid and the set values of other menus.	
③	[°C] lamp	Lights up when temperature is displayed on the digital display.	
④	[MPa] lamp	Lights up when pressure is displayed on the digital display part.	
⑤	[LPM] lamp	Lights up when flow rate is displayed on the digital display part.	
⑥	[H] lamp	Lights up when time is displayed on the digital display section.	
⑦	[SEC] lamp	Lights up when seconds are displayed on the digital display section.	
⑧	[RUN] lamp	Lights up when the product is started and in operation.	4
⑨	[ALM] lamp	Lights up when a fault occurs. (This product will stop.)	7
⑩	[WRN] lamp	Lights up when a warning occurs. (This product will continue operation.)	
⑪	[] lamp	Lights up when 「AL.01 Tank level drop failure」 or 「AL.02 Tank level drop」 alarm is generated.	-
⑫	Digital display (11 segment, 1 digits)	「X」 is displayed when notice for maintenance is generated.	5.4.4
⑬	[RMT] amp	Lights up during remote operation by communication function.	5
⑭	[KEYLOCK] amp	Lights up when key lock setting is active.	5.5.3
⑮	[RUN/STOP] key	Press and hold for 1 second to start or stop.	4.2
⑯	[MENU] key	Switching of each menu and cancellation of setting values.	5
⑰	[ENT] key	Switch to setting mode and set values.	
⑱	[▲] key	Move item upward or increase the set value.	-
⑲	[▼] key	Move item downward or decrease the set value.	-
⑳	[RESET] key	Reset the alarm.	7

Chapter 3 Transport and Setting Up

WARNING



- Only persons who have sufficient knowledge and experience about the product and system are allowed to transport and set up the product.
- Especially pay attention to personal safety.

3.1 Transport

The product is heavy and has potential danger at transport. Also, to prevent damage and breakage of the product, be sure to follow the instructions shown below for transport.

CAUTION



Never lay the product on its side.
The compressor oil will leak in to the refrigerant piping, which may cause early failure of the compressor.

CAUTION



- Drain the residual fluid from the piping as much as possible to prevent any spillage.

3.2 Installation

WARNING



- Do not set up the product in places possibly exposed to leakage of flammable gas. Should any flammable gas stay around the product, the product may cause a fire.
- Do not use the product outdoors. If the product subjected to rain or water splash it may cause electrical shock, fire or failure.

CAUTION



- Keep the product upright on a rigid and flat floor which can resist the weight of the product, and take measures to prevent the product from tipping over. Improper installation may cause water leakage, tipping, damage of the product or injure the operator.
- Keep the ambient temperature of the product between 5 to 40°C. Operation out of this ambient temperature range may cause a malfunction of the product. Operating the product in an environment temperature of 40 °C may reduce the heat discharging efficiency of the heat exchanger and the safety device may function, which stops the product operation.
- The installer/end user is responsible for carrying out an acoustic noise risk assessment on the equipment after installation and taking appropriate measures as required.

3.2.1 Environment

The product must not be operated, installed, stored or transported in the following conditions. Potential malfunction or damage to the product may occur if these instructions are disregarded.

- Location that is outside.
- Location that is exposed to steam, salt water or oil.
- Location that is exposed to dust or powder material.
- Location that is exposed to corrosive gas, organic solvent, chemical solution, or flammable gas. (The product is not explosion-proof.)
- Location where the ambient temperature is out of the following range:
In transportation and In storage 0 to 50°C
(with no water or circulating fluid in piping)
During operation 5 to 40°C
- Location where the ambient humidity is out of the following range or where condensation occurs:
In transportation and storage 15 to 85%
In operation 30 to 70%
- Location that is exposed to direct sunlight or heat radiation.
- Location that is near heat sources and poor in ventilation.
- Location that is subjected to abrupt changes in temperature.
- Location that is subjected to strong electromagnetic noise (intense electric field, intense magnetic field, or surges).
- Location that is subjected to static electricity, or conditions where static electricity can discharge to the product.
- Location that is subjected to strong high frequencies raditation(microwaves).
- Location that is subjected to potential lightning srtike
- Location at altitude of 3000m or higher (except during product storage and transport). Refer to below for details.
- Location where the product is affected by strong vibrations or impacts.
- Condition that applies external force or weight causing the product to be damaged.
Do not stack the product on top of each other.
- Location without adequate space for maintenance as required
- For the product installation or operation in accordance with UL standards, see below.

■ **Thermo-chiller installation in high altitude of 1000 meters or more**

Because of lower air density, the heat radiation efficiencies of the devices in the product will be lower in the location at altitude of 1000m or higher. For this reason, the maximum ambient temperature for the thermo-chiller operation and the cooling capacity will be reduced.

For product installation at a place of high altitude of 1000 meters or more, select a thermo-chiller of the applicable capacity referring to the table below.

1. Max. ambient temp.: Use the product in lower ambient temperature than the described value at each altitude.
2. Cooling capacity correction coefficient: Coefficient to calculate the cooling capacity at each altitude

■ **At an altitude of 1800 meters = Cooling capacity 8.4 x 0.8.**

Altitude [m]	1. Max. ambient temp. [°C]	2. Cooling capacity correction coefficient
Less than 1000m	40	1.00
1000 m or more - Less than 1500 m	38	0.85
1500m or more - Less than 2000m	36	0.80
2000m or more - Less than 2500m	34	0.75
2500m or more - Less than 3000m	32	0.70

■ **Installation/Operation in accordance with the UL standard (for the optional UL compliant model)**

For operation of the UL compliant model (available as an option, HRR012/018/024/030-A/W-10/20-*U) in UL compliant conditions, the product cannot be used in the environment shown below:

- Environment at an altitude of 2000 meters or more
- Environment at a pollution degree of 3 or more

3.2.2 Location

CAUTION	
	<ul style="list-style-type: none"> ● Do not install in a location which can be subjected to any of the conditions in “3.2.1 Environment”.

CAUTION	
	<p>The air cooled product radiates heat from the air vent of the cooling fan. If the product is operated with insufficient air ventilation the internal temperature can exceed 40°C, which can cause and affect the performance and life of the product. To prevent this ensure that suitable ventilation is available (see below).</p>

■ **Installation of multiple products**

Keep sufficient space between products so that the air vented from one product will not be taken in by other products.

■ **Installation at indoor site (for air cooled type)**

1. For a facility having a large installation area (that can vent the air naturally):
 Make an air outlet on a wall at a high level and air inlet on a wall at a low level, to allow for adequate airflow.

2. For a facility having a small installation area (that can not vent the air naturally):
 Make a forced air exhaust vent on a wall at a high level and an air inlet on a wall at a low level.

Table 3-1 Amount of radiation and required ventilation

Model	Heat radiation (kW)	Required ventilation amount (m3/min)	
		Differential temp. of 3 °C between inside and outside of installation area	Differential temp. of 6 °C between inside and outside of installation area
HRR012-A-10/20-*	Approx.2	40	20
HRR018-A-10/20-*	Approx.4	70	40
HRR024-A-10/20-*	Approx.5	90	50
HRR030-A-10/20-*	Approx.6	100	60

CAUTION



The water cooled product radiates heat to the facility water. It is necessary to supply the facility water. Please prepare the facility water system that satisfies the heat radiation and the facility water specifications below.

■ Required facility water system (for water cooled type)

Table 3-2 Facility water source to be prepared

Model	Heat Radiated kW	Facility water temp. range °C	Required facility water flow rate l/min		
			Facility water temperature		
			25°C	32°C	40°C
HRR012-W-10/20-*	Approx.2	5 to 40 (Rating 25)	8	12	20
HRR018-W-10/20-*	Approx.4		12	15	23
HRR024-W-10/20-*	Approx.5		14	17	25
HRR030-W-10/20-*	Approx.6		15	18	26

3.2.3 Installation and Maintenance Space

It is recommended to keep the space around the product shown in Fig 3-1

⚠ CAUTION

! Have an enough space for the ventilation for the product. Otherwise it may cause a lack of cooling capacity or/and stoppage of the product. Ensure there is enough space for maintenance.

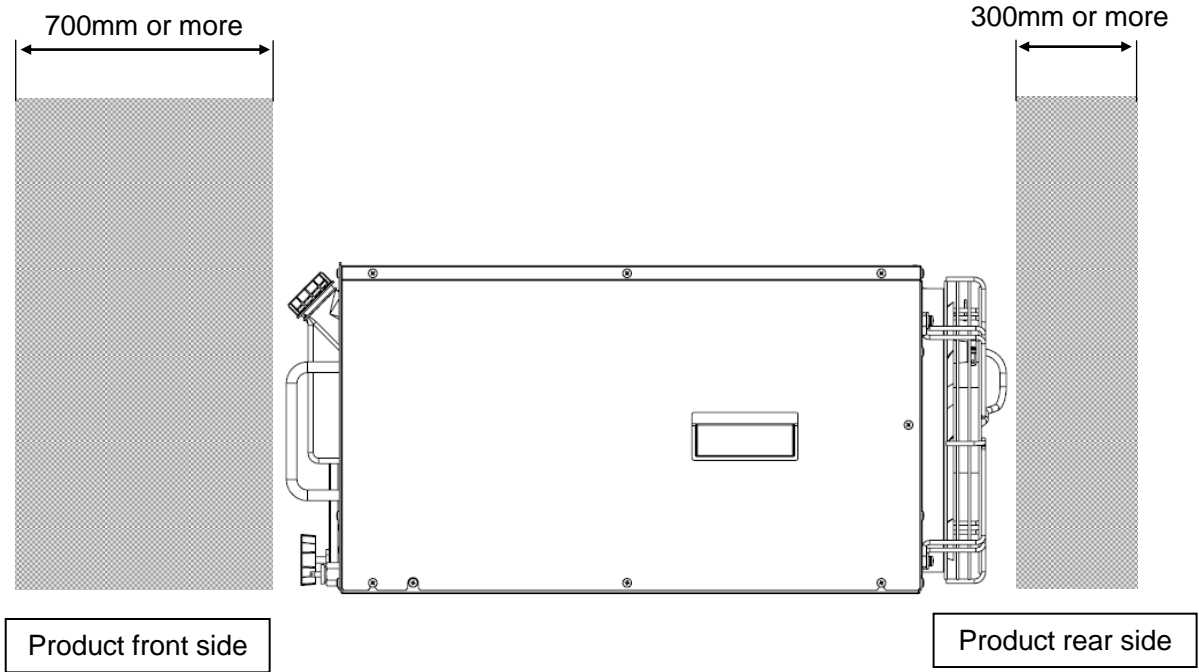

Fig 3-1 Installation space(View from the side of the product)

⚠ CAUTION

! The temperature of the outlet for the ventilation of the thermo-chiller and the panel surface may become approx. 50°C or higher. When placing the thermo-chiller, ensure the thermo-chiller does not affect surrounding environment.

3.3 Installation

3.3.1 Mounting

■ How to mount the product

- 1.** When mounting the product to a cabinet, use a design which shall hold the weight at the bottom. Ensure safety with transportation test if the product is to be installed on a transportation device such as a trailer. Mount the product using the fixing holes in the front of the product. Use M5, M6 screws (bolts) or equivalent to fix the product.

Do not drag this product after mounting, as the feet may be damaged. (option -Y)

- 2.** In the case of air cooling type, this product sucks air from the front and discharges it to the back. Please do not block the suction and the discharge air. Please do not install in a sealed place. (Refer to 3.2.3 "Installation and maintenance space".)

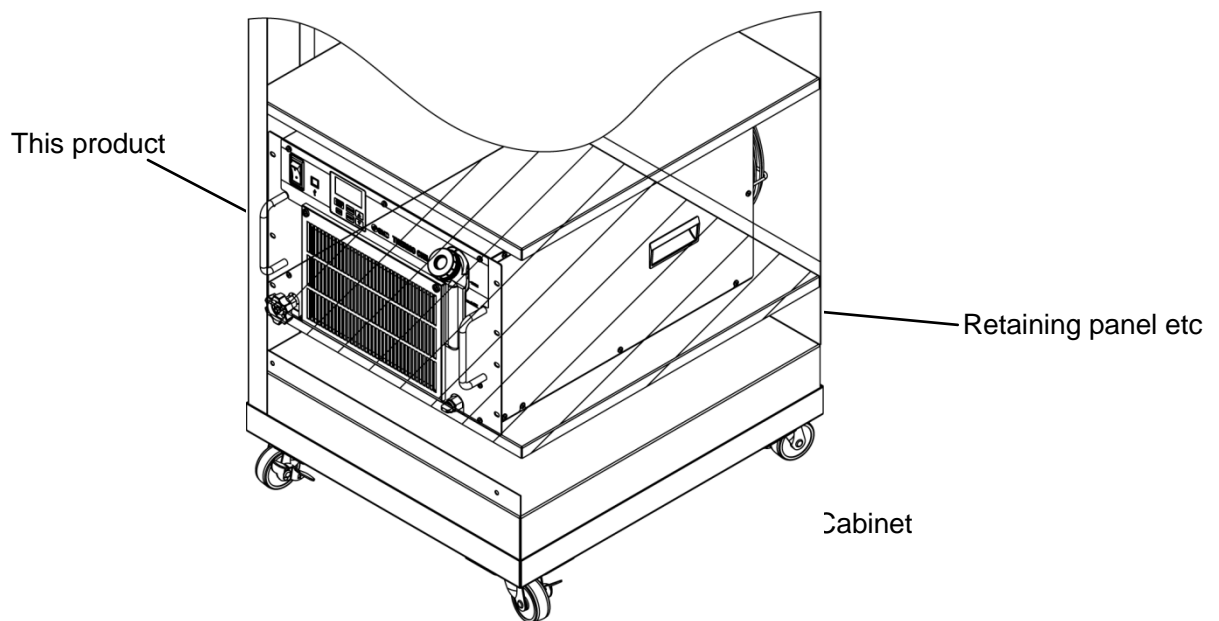

Fig 3-1 Mounting

3.3.2 Electrical wiring

⚠ WARNING



- Do not modify the internal electrical wiring of the product. Incorrect wiring may cause electric shock or fire. Also, modifying the internal wiring will void the product's warranty.
- NEVER connect the ground to water line, gas pipe or lightning conductor.

⚠ WARNING



- The installation of electrical equipment and wiring work should be performed only by personnel with sufficient knowledge and experience.
- Be sure to shut off the user's power supply. Wiring with the product energized is strictly prohibited.
- The wiring must be conducted using cables complying with "Table 3-3" and firmly secured to the product to prevent the external force of cables being applied to the terminals. Incomplete wiring, or improper securing of wiring, may cause electrical shock or excessive heat and fire.
- Ensure a stable power supply with no voltage surges.
- Ensure that an earth leakage breaker is used in the power supply of the product. See "Table 3-3".
- Use a power supply suitable for the specifications of the product. Use a power supply of over voltage category 3 (IEC60664-1)*.
- Be sure to connect the ground connection.
- Ensure that a lock out facility is available on the power supply.
- Each product must have its own separate earth leakage breaker. Otherwise there can be a risk of electric shock or fire.
- Ensure that no harmonics are superimposed at power supply. (Do not use inverter, etc.)
- Supply a steady power supply which is not affected by surges or distortion. In particular, if the voltage rate of increase (dv/dt) at zero crossing exceeds $40V/200\mu\text{sec}$, it may cause malfunction.

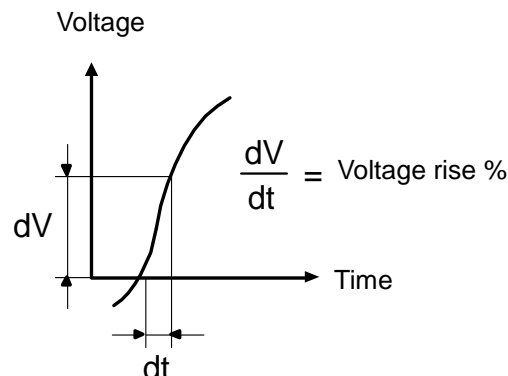

*: For the users that purchased Option U for the product operation in the UL compliant conditions, please refer to "Installation/Operation in accordance with the UL standard" in the next page.

■ **Power supply specifications, power supply cable and earth leakage breaker**

Prepare the power supply shown in the following table. For the connection between the product and power supply, use the power supply cable and earth leakage breaker shown below. An earth leakage breaker must be mounted to a position where the breaker is easily accessible and close to the thermo-chiller.

Table 3-3 Power supply cable and earth leakage breaker (Recommended)

Model (High pump head [Optional])	Power supply voltage	Cable qty. x size	Recommended earth leakage breaker	
			Rated current (A)	Sensitivity of leak current [mA]
HRR012-A/W-10-*	1-phase AC100V (50/60Hz) 1-phase AC115V (60Hz)	3 cores x 14AWG (3 cores x 2.0mm ²) (including ground)	15	30
HRR018-A/W-10-*				
HRR012-A/W-20-*	1-phase 200-230V AC (50/60Hz)		10	30
HRR018-A/W-20-*				
HRR024-A/W-20-*				
HRR030-A/W-20-*				
HRR012-A/W-20-*T*				
HRR018-A/W-20-*T*				
HRR024-A/W-20-*T*				
HRR030-A/W-20-*T*				
HRR012-A/W-20-*T1*				
HRR018-A/W-20-*T1*				
HRR024-A/W-20-*T1*				
HRR030-A/W-20-*T1*				

■ **Installation/operation in accordance with the UL standard (for the optional UL compliant model)**

For operation of the UL compliant model (available as an option, HRR012/018/024/030-A/W-10/20-*U) in the UL compliant conditions, the conditions shown below must be satisfied:

- Use power supply of overvoltage category 2 (transient overvoltage 2500 V or less) *1

*1 When using a power supply in the overvoltage category 3, take measures such as mounting an isolation transformer between the product and the power supply or keep the transient overvoltage of the power supply to 2500 V or less by using a varistor, etc.

3.3.3 Preparation and wiring of power supply cable

WARNING



- The electrical facilities should be installed and wired in accordance with local laws and regulations of each country and by a person who has knowledge and experience.
- Check the power supply. Operation with voltages, capacities and frequencies other than the specified values can cause fire and electric shock.
- Wire with an applicable cable size and terminal. Forcibly mounting with an unsuitably size cable may result in heat generation or fire.

WARNING



Be sure to lock out and tag out the breaker of the facility power supply (customer power supply facility) before wiring.

WARNING



Be sure to connect the power supply cable from the product side first, and then connect the breaker of the facility power supply (the user's machine power supply).

CAUTION



- Please wear protective gloves.
- Use a separate outlet or earth leakage breaker.
- Be sure to perform grounding (earth).
- Failure to do so may cause malfunction or electric shock.

■ Preparation

1. Prepare the cable and individual socket or earth leakage breaker shown in the table below.
2. Strip the sheath from both ends of the cable.
3. Disassemble the power supply connector (supplied as an accessory) and mount one end of the cable to the L, N and E terminals and reassemble the power supply connector.
4. Connect the other end of the cable to crimped terminals that are connectable to the power supply facility.

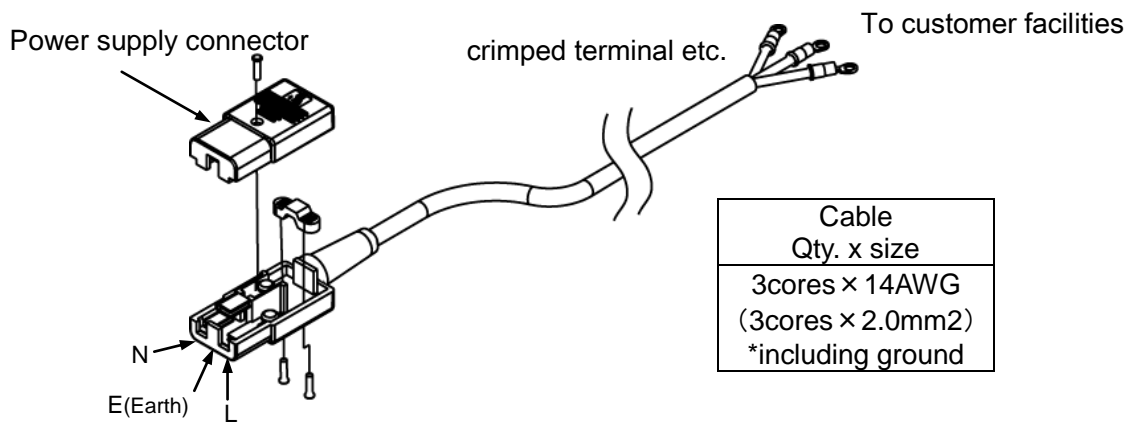

Fig 3-3 Cable connection

5. Insert the power supply connector to the power supply connector socket.
6. Connect the crimped terminals to the secondary side of the earth leakage breaker and grounding on the power supply facility

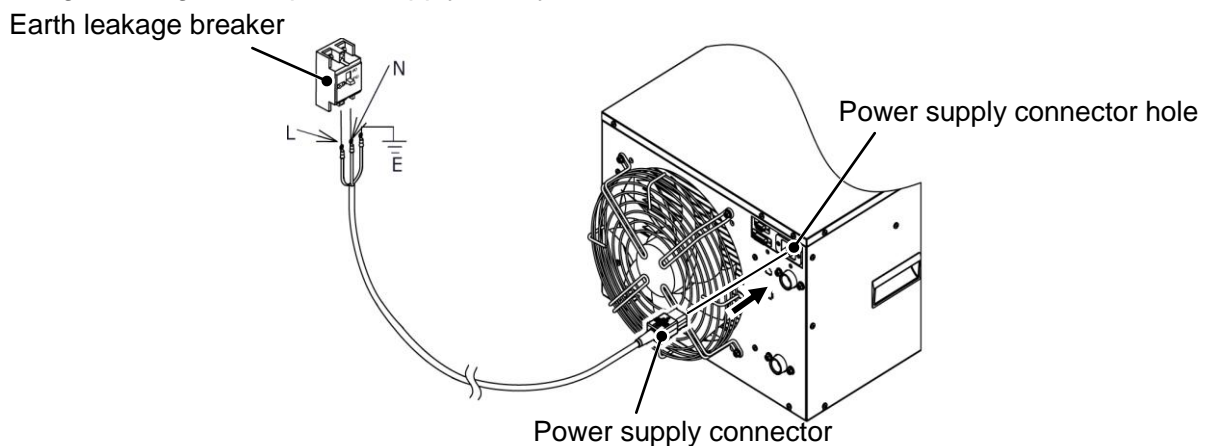



Fig 3-4 Power supply connector connection

3.3.4 Contact input/output communication wiring

⚠ WARNING



Be sure to lock out and tag out the breaker of the facility power supply (the user’s machine power supply) before wiring.

CAUTION

Use a connector that is specified.

The capacity of the output contact of the product is limited. If the capacity is not large enough, install a relay, etc. (to allow for larger capacity). Also, ensure that the input current of the relay is small enough in relation to the contact capacity of the product.

The product has a contact input/output communication function as shown below. Connect cables referring to the applicable chapter for each function. (For details of the functions, refer to Operation Manual Communication Function.)

- Run/Stop input · Remote signal input (Refer to “3.3.5 Wiring of run/stop signal input and remote signal input”)
- Output of contact output signal (Refer to “3.3.6 Wiring of contact output signal Wiring of contact output signal”)

Use the signal cable described below for wiring of each function.

■ Contact Input/Output communication connector

The following connectors are used for this product as a contact input / output signal connector. Please prepare suitable mating connector cable.

Table 3-4 Contact input/output communication connector

Connector specification (this product side)
Dsub 15 pin female (socket) type

Table 3-5 Contact input/output communication specification

	Item	Specification	
Contact input signal _{1,2}	Insulation system	Photo coupler	<ul style="list-style-type: none"> ▪ Run/Stop signal ▪ External switch signal
	Rated input voltage	DC24V	
	Used input voltage	DC 21.6V to 26.4V	
	Rated input current	5mA TYP	
	Input signal	4.7kΩ	
Contact output signal _{1,2,3}	Rated load voltage	AC48V or less /DC30V or less	<ul style="list-style-type: none"> ▪ Signal of operating status ▪ Signal for the alarm status ▪ Signal for completion of preparation (TEMP READY) etc *2
	Maximum load current	AC/DC 500mA (Resistance load)	
	Minimum load current	DC5V 10mA	
	DC24V output voltage	DC24V ± 10% 500mA MAX *1 (It can not be used for inductive load.)	

*1 : When using the power supply of this product, make sure that the total load current is 500 mA or less.

*2 : Refer to "3.3.6 Wiring of contact output signal".

Table 3-6 Contact input/output pin number

PIN no	Application	Division	Initial value (Default setting)
1	DC 24V output	Output	
2	DC 24V output	Output	
3	DC 24V output	Output	
4	Contact input signal 1	Input	None
5	COM of contact output signal 1	Output	
6	COM of contact output signal 2	Output	
7	COM of contact output signal 3	Output	
8	None	-	
9	24 COM output	Output	
10	24 COM output	Output	
11	COM of contact input signal	Output	
12	Contact input signal 2	Input	None
13	Contact output signal 1	Output	Run status signal (N.O type)
14	Contact output signal 2	Output	Remote signal (N.O type)
15	Contact output signal 3	Output	Alarm signal (N.C type)

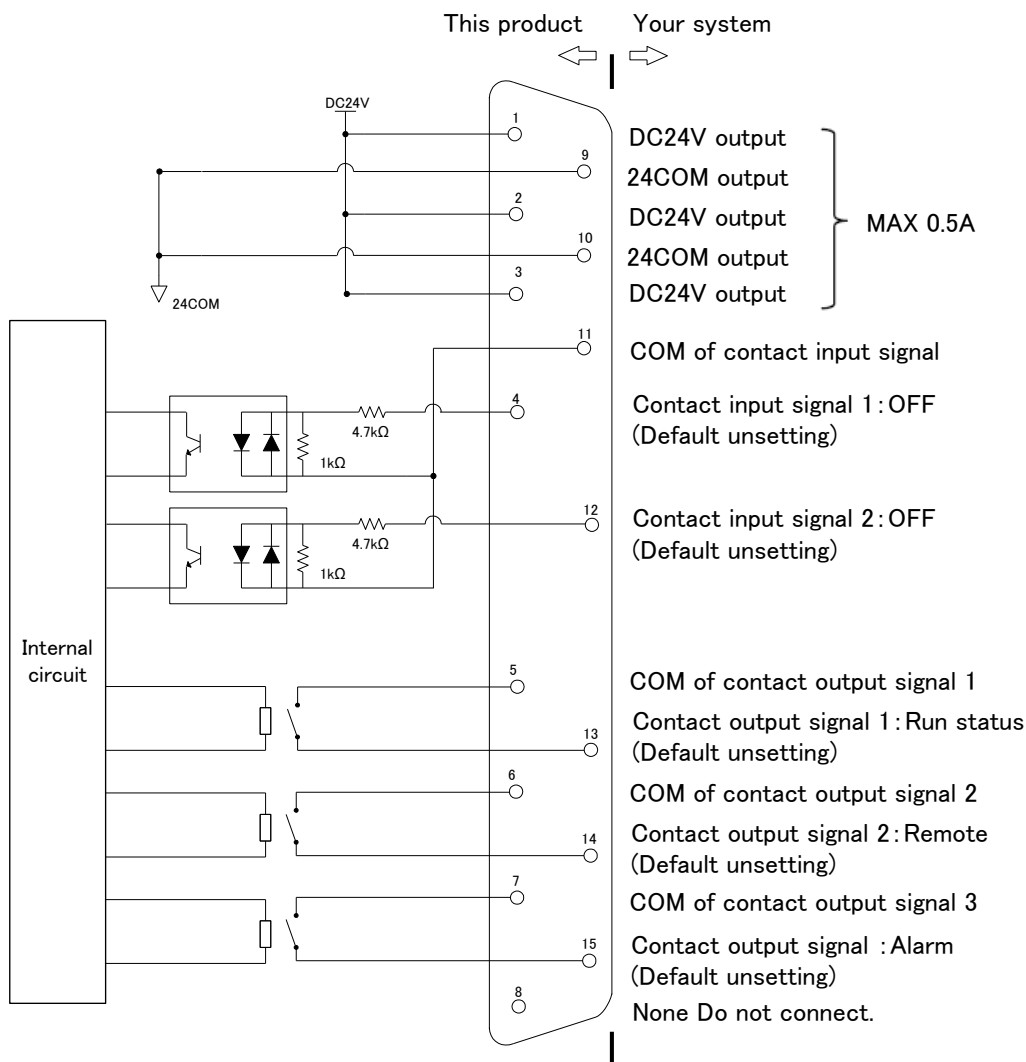

Fig 3-5 Contact input/output

3.3.5 Wiring of run/stop signal input and remote signal input

Run/Stop signal input and remote signal input enable the product to run/stop remotely by applying a contact signal input. This chapter illustrates examples of wiring.

To enable the run/stop signal input or remote signal input, after wiring, set the item "Contact input signal 1 function selection" in "Communication setting menu" from "OFF (initial setting value)" → to "RN .ST".

[Tips]

This product has two input signals. These can be customized depending on the customer's application.

1. Prepare a suitable connector cable.
2. Wire the contact input / output signal connector as shown below and connect it to this product. (This wiring is an example, please refer to the instruction manual "Communication function" for details.)

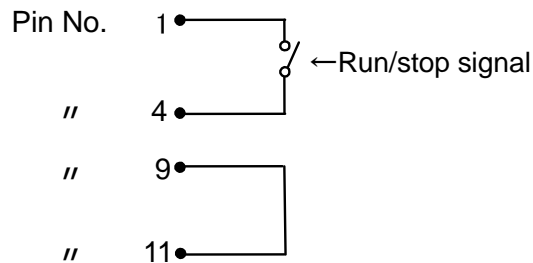
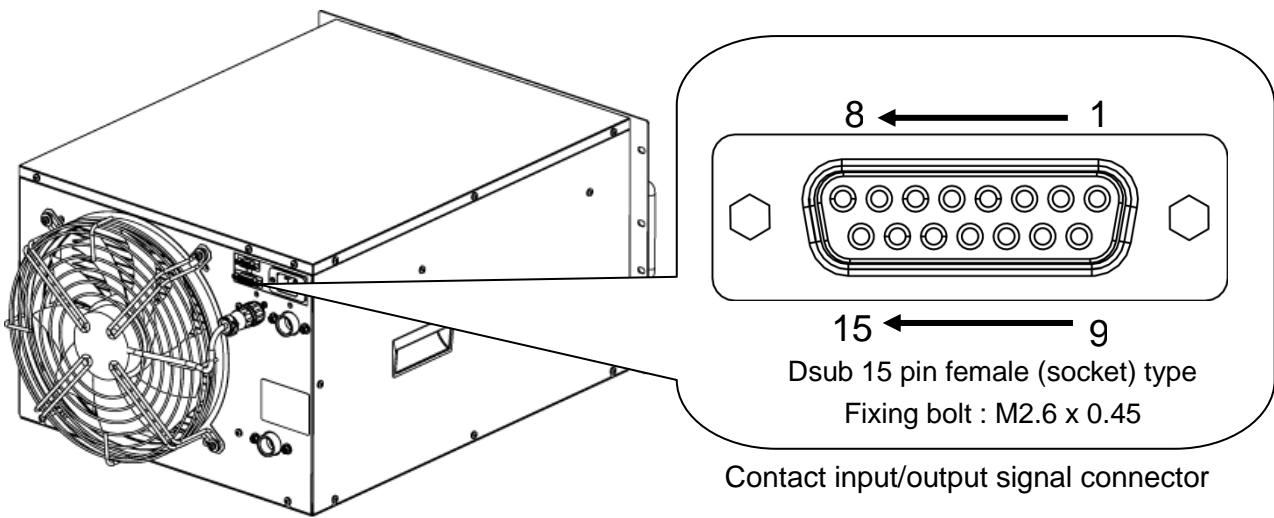



Fig 3-6 Wiring of run/stop signal input (Example)

3.3.6 Wiring of contact output signal

Contact output signals are the signals that output the status of this product.

⚠ WARNING	
	Be sure to turn OFF the breaker of the facility power supply (the user's machine power supply) before wiring.

Contact specification of each signal output is shown below.

Table 3-7 Signal output contact spec. at the time of shipment

Contact output	Content of the signal (Default setting)	Operation		
Contact output signal 1	Operation status signal output	N.O.	During operation:	Contact closed
			During operation stop:	Contact open
			With power supply cutoff:	Contact open
Contact output signal 2	Remote status signal output	N.O.	During remote operation:	Contact closed
			During non-remote operation:	Contact open
			With power supply cutoff:	Contact open
Contact output signal 3	Alarm status signal output	N.C	While alarm being generated:	Contact open
			While alarm not being generated:	Contact closed
			With power supply shut off:	Contact open

[Tips]

This product has three output signals which can be customized depending on the user's application
Signals shown below can be output. Refer to Operation Manual "Communication Function" for more details.

- Run status signal is output
- Remote status signal is output
- Signal for completion of preparation (TEMP READY) is output
- Out of temperature range status signal is output
- Signal for operation stop alarm is output
- Signal for continuing operation alarm is output
- maintenance status signal is output
- Alarm status signal is output
- Pass through signal of contact input signal is output
- Selected alarm status signal output
- Signal for selection maintenance is output

3.3.7 RS-485 communication wiring

Serial communication RS-485, operation Start/Stop, setting and reading of circulating fluid temperature, and reading of alarm condition can be performed by remote control.

Refer to Operation Manual "Communication Function" for more details.

■ RS-485 communication connector

The following connector is used for this product as a connector for RS - 485 communication.

Please prepare suitable mating connector.

Table 3-8 RS-485 communication connector

Connector specification (this product side)
Dsub 9 pin female (socket) type

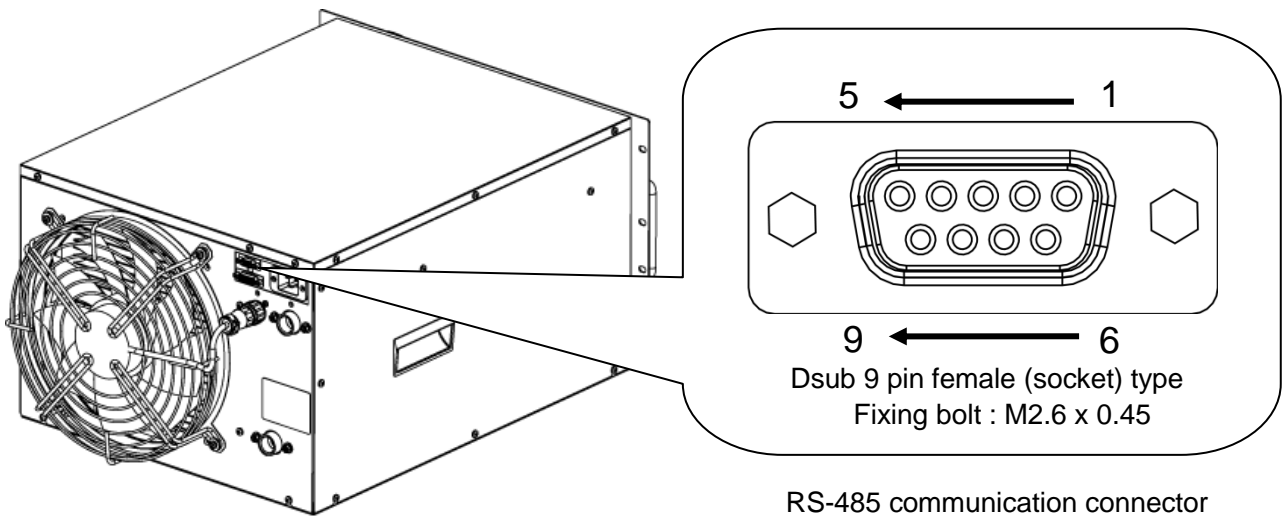



Fig 3-6 RS-485 communication connector

■ Wiring of interface communication cable

⚠ WARNING



Be sure to turn OFF the breaker of the facility power supply (the user's machine power supply) before wiring.

- Connecting to PC

RS-485 cannot be directly connected to a normal PC. Use an RS-232C/RS485 converter which is available on the market.

Be sure to follow the wiring procedure shown below for connecting multiple thermo-chillers.

- Configuration of connection

One thermo-chiller for one host computer, or multiple thermo-chillers for one host computer.(31 thermo-chillers can be connected at maximum.)

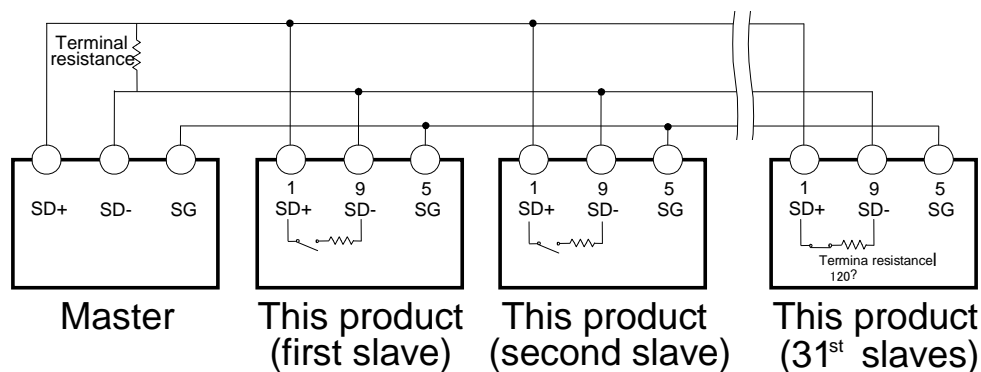

Do not connect any wire to other PIN numbers.

Fig 3-7 Connection of RS-485

[Tips]

Both ends of the communication connection (the end nodes) need to be connected to the host computer.

With or without the terminating resistor of this product can be set by the operation display panel. Refer to "5.5.5 Communication setting menu"

3.3.8 RS-232C communication wiring

Serial communication RS-232C, operation start/stop, setting and reading of circulating fluid temperature, and reading of alarm condition can be performed by remote control.

Refer to Operation Manual “Communication Function” for more details.

■ RS-232C communication connector

The following connector is used for this product as RS-232C communication connector. Please prepare suitable mating connector.

Table 3-9 RS-232C communication connector

Connector specification (this product side)
Dsub 9 pin female (socket) type

■ Wiring of communication cable

⚠ **WARNING**



Be sure to turn OFF the breaker of the facility power supply (the user's machine power supply) before wiring.

Be sure to wire as shown in the figure below.

● Configuration

One thermo-chiller for one master.

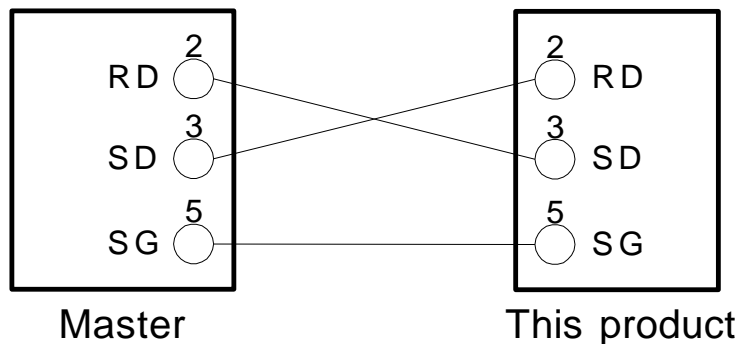

Do not connect any wire to other PIN numbers.

Fig. 3-8 Connection of RS-232C

3.4 Piping

CAUTION



- Connect piping firmly. Incorrect piping might cause leakage of supplied or drained fluid and wet surrounding area and facility.
- Use caution not to allow dust and foreign matter to enter the water circuit, etc. during connection of piping.
- Securely connect the piping at the piping port with specific wrench when tightening.
- Incorrect piping can burst in service.
- Use non-corrosive material for fluid contact parts of circulating fluid and/or facility water. Using the materials that tend to rust or corrode may cause clogging or/and leakages of the circulating fluid and facility water circuits. In case of using these kinds of materials, consider and carry out some prevention against the rusting or corrosion by the customer side.
- Do not generate a rapid change of pressure by water hammer, etc. Internal parts of the product and/or the piping may be damaged.
- It is recommended to use heat insulation to reduce the heat radiation and absorption to/from customer's piping.

CAUTION



Check the model number of this product in "1.4 Product Label" of this manual before connecting piping.
Model number: HRR012/018/24/030-AN/WN-10/20
 The transition connector from Rc to NPT is enclosed as an accessory.
 For NPT piping, be sure to use this connector.
Model number: HRR012/018/024/030-AF/WF-10/20
 The transition connector from Rc to G is enclosed as an accessory.
 For G piping, be sure to use this connector.

■ Piping port size

Table 3-10 Piping port size

Description	Port size	Recommended tightening torque	Recommended piping specifications
Circulating fluid outlet port	Rc1/2	28 to 30N·m	0.4MPa or more ^{*2}
Circulating fluid return port	Rc1/2	28 to 30N·m	0.4MPa or more ^{*2}
Facility water inlet port ^{*3}	Rc3/8	22 to 24N·m	1.0MPa or more (Supply puressure: 0.3 to 0.5MPa)
Facility water outlet port ^{*3}	Rc3/8	22 to 24N·m	

*1 For NPT and G thread, use a conversion connector available as an accessory separately.

*2 In the case of option T and T1, 1.0 MPa or more

*3 For water-cooled type.

[Tips]

<For HRR012/018/024/030-AN-20-*, HRR012/018/024/030-WN-10/20-*>

A set of thread adapters that converts the connections from Rc to NPT is enclosed as an accessory. For NPT thread, be sure to use this adapter.

<For HRR012/018/024/030-AF-10/20-*, HRR012/018/024/030-WF-10/20*>

A set of thread adapters that converts the connections from Rc to G is enclosed as an accessory. For G thread, be sure to use this adapter.

■ How to connect piping

1. Ensure that the power source and the power supply of the Product is turned off (or the power plug is disconnected).
2. This product generates an alarm^{*1} and stops running when the circulating fluid flow rate becomes 2 L/min or less. Please make piping that flows more than 2 L/min.
In addition, this product generates an alarm and stops when the circulating fluid discharge pressure becomes 0.5 MPa^{*2} or more.
*1 For options Z and Z1 no alarm is generated. For models with options T1 and Z or T1 and Z1, the alarm will occur at less than 7L/min.
*2 For option T1, 0.4MPa or more.

CAUTION



**Make piping so that the circulating fluid always flows.
The product will break down if it is operated with no circulating fluid flowing.**

[Tips]

When delivered, the bypass valve of this product is in the "open" state. Adjust the bypass valve according to usage situation.

3. Connect the circulating fluid return port with the user's machine outlet.
4. Connect the circulating fluid discharge port with the user's machine inlet.

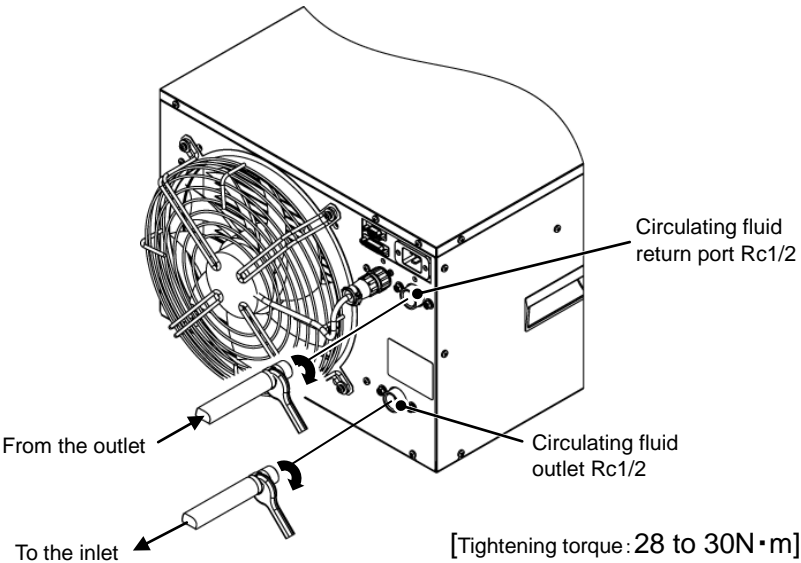
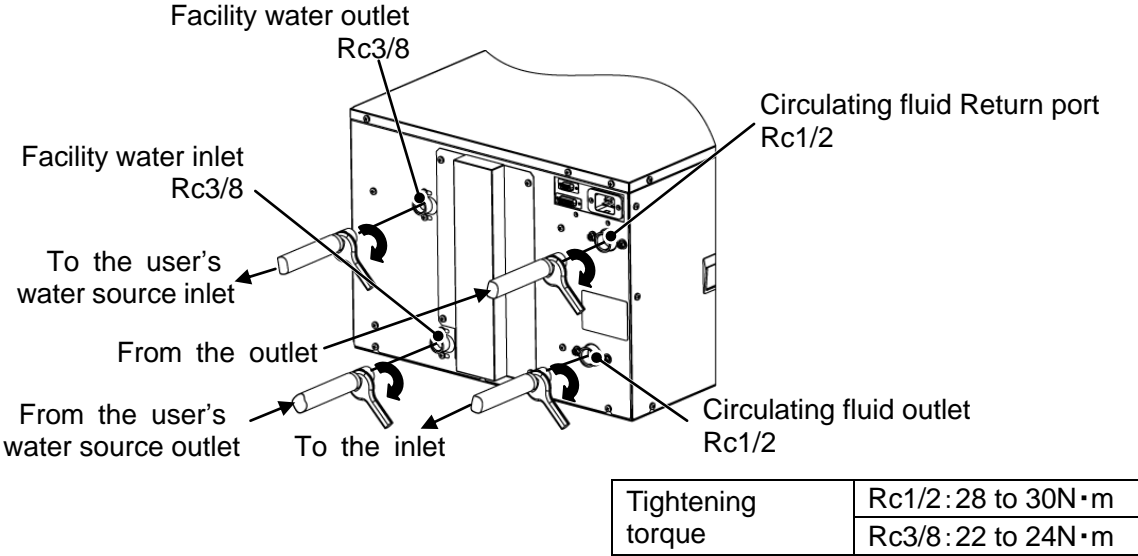

Fig. 3-9 How to connect piping (For air-cooled type)

5. In case of water-cooled type, please also connect the piping of the facility water inlet and outlet of the customer's water source equipment.



Recommended piping circuit

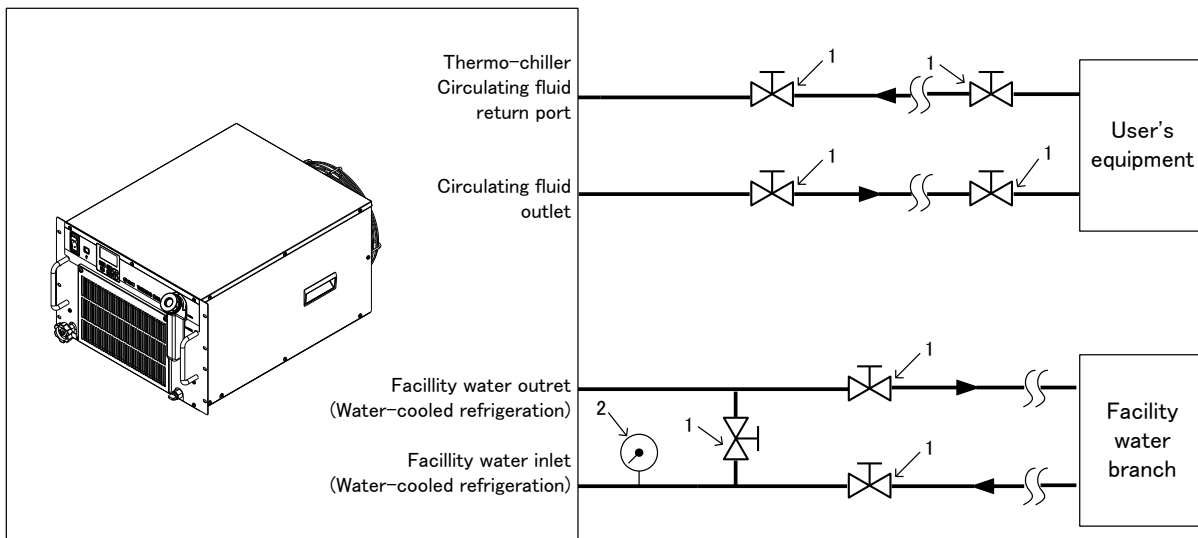

Fig. 3-10 Recommended piping circuit

No	Description	Size
1	Valve*	Rc1/2
2	Pressure gauge	0 to 1.0MPa
3	Pipe,hose,etc.	inside diameter Φ 15 or more

* To prevent liquid spillage from the customer's piping or overflow from the tank during maintenance work.

3.5 Fill of circulating fluid

1. Ensure that the power source and the power supply of the product is turned off.
2. Check the drain port is plugged to prevent the supplied circulating fluid from draining out.
3. Open the circulating fluid inlet cap by turning it counterclockwise, and fill the circulating fluid within the range from LOW to HIGH shown on the level gauge. Use tap water which satisfies the water quality standard shown in Table 8-1, or a 15% aqueous solution of ethylene glycol.
4. After filling to the specified level, turn the lid clockwise to close.

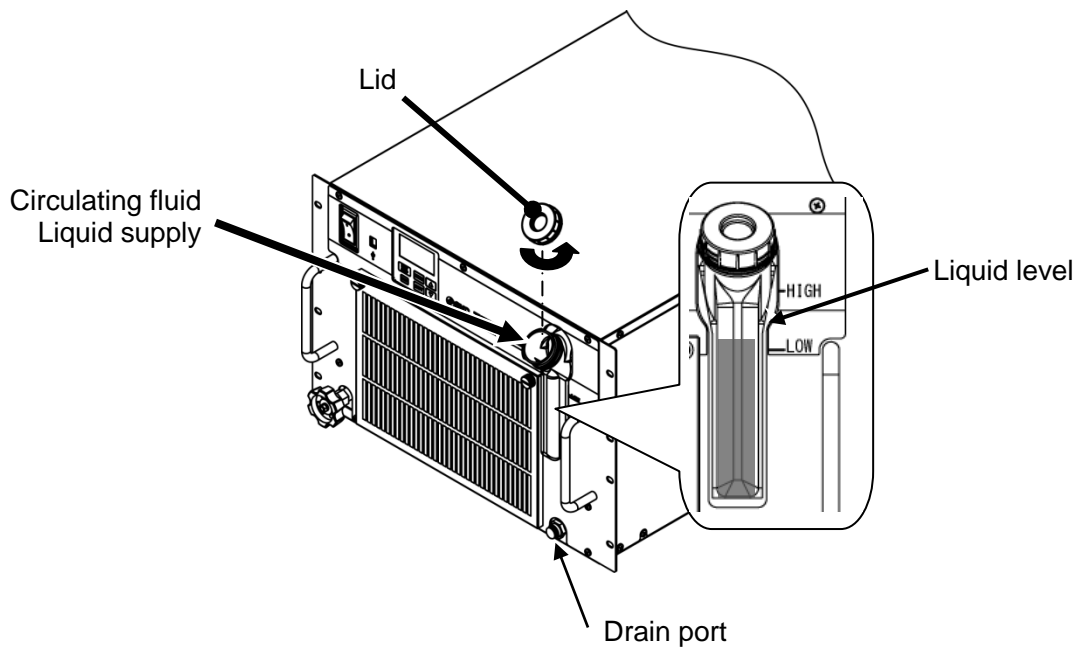

Fig. 3-11 Fill of circulating fluid

■ 15% aqueous solution of ethylene glycol

When a 15% aqueous solution of ethylene glycol is used, prepare the ethylene glycol aqueous solution separately.

To control the concentration of the ethylene glycol aqueous solution, a concentration meter is available separately from SMC.

Item	No	Remarks
Ethylene glycol aqueous solution 60%	HRZ-BR001	Please dilute to 15% with tap water and use it.
Densitometer	HRZ-BR002	-

Chapter 4 Starting the Product

CAUTION



Only people who have sufficient knowledge and experience about the product and its accessories are allowed to start and stop the product.

4.1 Before Starting

Check the following points before starting the product.

■ Installation state

- Check that the product is installed horizontally.
- Check that there are no heavy objects on the product, and the external piping is not applying excessive force to the product.

■ Connection of cables

- Check that the power, ground and signal cables (to be supplied by user) are correctly connected.

■ Circulating fluid piping

- Check that the circulating fluid piping is correctly connected to the inlet and outlet.

■ Fluid level gauge

- Confirm that the fluid level is between 'HIGH' and 'LOW' levels of the fluid level gauge.

■ Facility water piping (for water cooled type)

- Check that the piping is correctly connected to the facility water inlet and outlet ports.
- Confirm that the facility water source is in operation.

CAUTION



- Facility water quality must satisfy the quality standard shown in "8.1 Quality Control of Circulating Fluid and Facility Water" and the conditions shown in "9.1 Specifications".

[Tips]

A water control valve is mounted inside the water cooled type thermo-chiller. For the water cooled type, facility water may not run without operating the product.

4.2 Starting and Stopping

4.2.1 Operation

1. Please supply power to this product

Turn on the power switch. The operation display panel lights up. At this point, this product is in the "Stopped" state (Please note that operation is started after the power is turned on when the operation signal is sent in the remote setting state.)

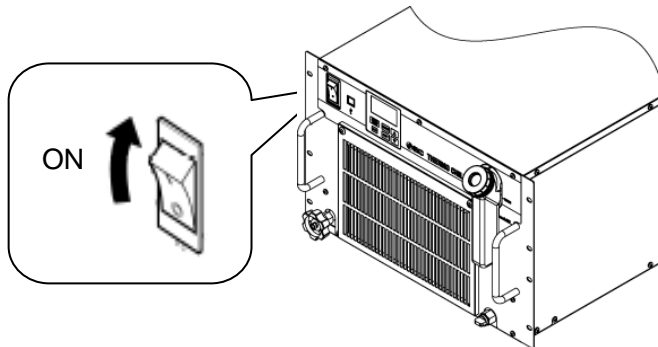

Fig. 4-1 Power switch location

2. Set the circulating fluid temperature. When you press the "ENT" key, the set temperature (lower part of numerical value display: green) flashes. Press the [▲] [▼] key to set the target temperature, then press the "ENT" key to set. (Flashing ends when set.) Please refer to various setting / display.

-
- 3.** Press and hold [RUN / STOP] key for 1 second. The [RUN] lamp lights up and operation starts.
- * When you operate for the first time after piping, the circulating fluid in the tank decreases until the circulating fluid is filled in the piping. (An alarm occurs when the liquid level falls below "LOW".) When the circulating fluid in the tank decreases, repeat "Circulating liquid supply" procedure so that the liquid level is within the range from LOW to HIGH.
 - * 30 seconds after start of operation, if the circulating fluid flow rate is less than 2 L / min, an alarm occurs and the product stops. Ensure that the circulating fluid flow rate will be 2 L / min or more.
 - * In the case of option Z, Z1, the alarm of the flow rate decrease does not generate. Make piping so that the circulating fluid always flows. The product will break down if it is operated with no circulating fluid flowing.
 - * For options Z and Z1 no alarm is generated. For models with options T1 and Z or T1 and Z1, the alarm will occur at less than 7L/min.
 - * When using option T (high head pump specification), if the circulating fluid discharge pressure becomes 0.5 MPa or more, an alarm occurs and this product stops. Refer to "4.3 Adjustment of bypass valve" and make it to 0.5 MPa or less.
 - * For option T1, an alarm will occur and the product will stop when the circulating fluid discharge pressure exceeds 0.4 MPa. Refer to "4.3 Bypass valve adjustment" or "Pump output setting value" in the main menu display content of 5.4.2, and set it to 0.4MPa or less. The factory default pump output setting is 90%.

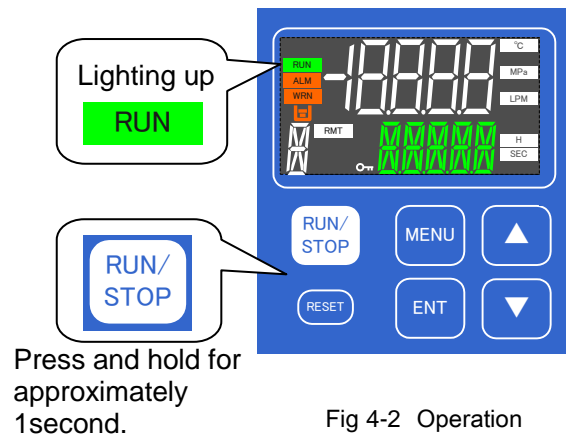

Fig 4-2 Operation

[Tips]

In the first operation after water supply, be sure to start the operation with the bypass valve open. The pump may not be supplied with the fluid, which reduces the life of the pump.

After confirming that the circulating fluid has flowed, adjust the pressure on flow rate with the bypass valve.

4.2.2 Operation restart when alarm is generated

This product has two types of operation depending on the alarm being generated. The restart is different depending on the operation mode.

[1] When the following alarm occurs, this product stops.

- AL01: Low level in tank
- AL09: Circulating fluid discharge pressure rise (Select from WRN/ FLT)
- AL17: flow rate failure (Not generated for options Z and Z1.)
- AL18: High circulating fluid discharge temp
- AL19: High circulating fluid return temp.
- AL21: High circulating fluid discharge pressure
- AL22: Low circulating fluid discharge pressure
- AL24: Memory abnormal
- AL25: Contact input 1 signal detection (Select from OFF/ WRN/ FLT)
- AL26: Contact input 2 signal detection (Select from OFF/ WRN/ FLT)
- AL27: forced a stop
- AL30: refrigerant circuit abnormal
- AL31: sensor abnormal
- AL32: controller abnormal

After resetting the alarm (Refer to 「10. How to Reset Alarms」) when resuming operations press and hold the [RUN/STOP] key for approximately 1 second. (Refer to “Chapter 7 Alarm Notification and Troubleshooting”)

- [2] When alarms except those shown above are generated the compressor stops, and the circulating fluid pump continues running for a fixed time (*). At this time, the "RUN" lamp flashes. In case of resetting the alarm (Refer to 7.3 "What to do when an alarm occurs") while the pump is operating, pressing the "RUN / STOP" key once (1 second) causes the compressor to operate and the operation of the product will resume. (This operation only occurs when this function is set. For details, refer to 5.3.6 Alarm Setting Menu.)

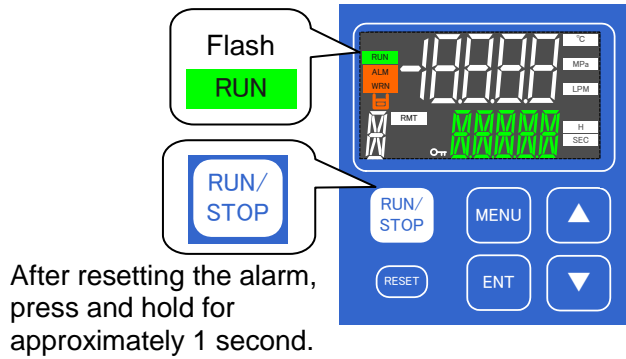

Fig 4-3 Restart operation when an alarm occurs

To stop the product when only the pump is running, press and hold the [RUN/STOP] key for approximately 5 seconds. (When this operation is performed, an alarm "AL27: forced a stop " occurs.)

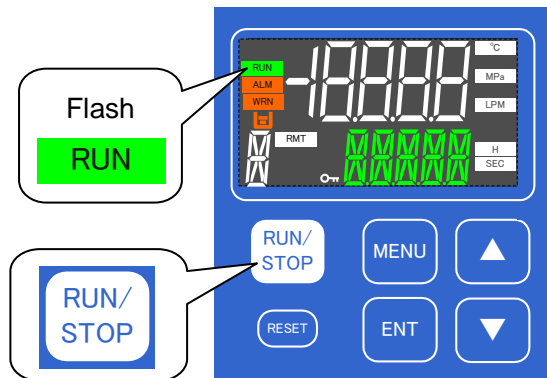

Fig 4-4 Restart operation when an alarm occurs

*The time to run the pump can be set within the range of "0 to 9999 seconds". The factory setting is "0 seconds". Therefore, when an alarm occurs, the operation is as in operation mode [1] .the operation of the pump stops and the product stops. However, if the user sets the pump operation time greater than 0s, the pump only runs until the circulating fluid discharge temperature reaches a certain value. The factory setting is set to 40 °C (The cut off temperature can be set by the user within the range of 5 °C to 45 °C. See "5.3.6 Alarm Setting Menu" for details).

4.2.3 Stopping the product

Press and hold the [RUN / STOP] key for 1 second.
[RUN] lamp goes out and operation stops.

*It takes about 10 seconds of operation to prepare to stop before it stops.
During the stopping preparation the [RUN] lamp flashes.

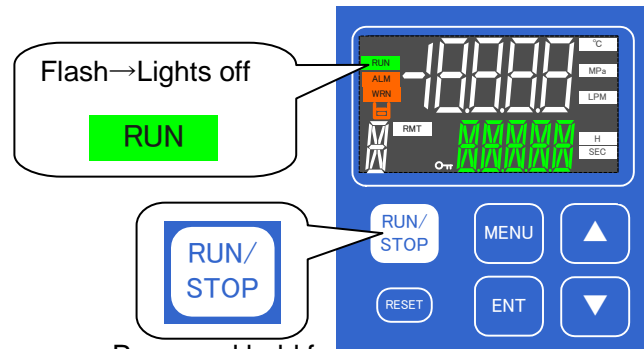

Press and hold for approximately 1 second.

Fig 4-5 Stopping the product

CAUTION



Except in case of an emergency, do not turn OFF the breaker before the thermo-chiller stops operation completely.

4.3 Adjustment of bypass valve

This product has a circulating fluid bypass valve installed(Not installed for option Z).

The bypass valve is opened when delivered. Adjust valve opening according to customer's usage situation.

Also, if circulating fluid temperature is not stabilized, shortage of circulating fluid flow may be considered. In such a case adjust the valve and increase the circulating fluid flow from this product.

*The circulating fluid flow indicated by this product does not include flow through the bypass. Please note that as the circulating fluid discharge pressure decreases when the valve is opened, the display flow rate of this product will decrease.

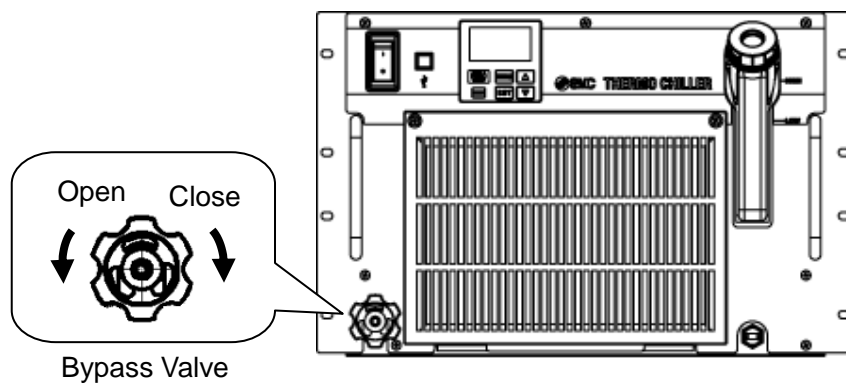



Fig 4-6 Adjustment of bypass valve

4.4 Check items after starting

Check the following items after starting the product.

⚠ WARNING	
	When an Alarm is seen, after stopping the operation of this product and then turn off the power supply switch to stop the product, and turn off the breaker of the user's power supply to isolate the product.

- Confirm that there is no leakage from the piping
- Confirm that no circulating fluid is discharged from the tank drain port.
- Confirm that the circulating fluid pressure is within the specification range.
- Confirm that the fluid level shown by the fluid level gauge is within the specification range.

Chapter 5 Display and Setting of Various Functions

⚠ WARNING



Read and understand this manual carefully before changing the settings.

5.1 List of Functions

The product can have the displays and settings shown in Table 5-1.

Table 5-1 List of functions

No.	Item	Outline	Reference page	
1	Basic setting mode	Main menu	Displays the current temperature and set temperature of circulating fluid. Change circulating fluid setting temperature. By pressing the [▲] [▼] key, circulating fluid return temperature, circulating fluid discharge pressure, circulating fluid flow rate(except option Z, Z1), electric conductivity (option DM only) are displayed.	5.4.2
2		Alarm display menu	When an alarm occurs, the alarm number is displayed. Only the currently occurring alarms are displayed.	5.4.3
3		Maintenance notification menu	Notification function of maintenance time. When pump, fan, refrigerator, dustproof filter, DI filter is replaced, it is displayed.	5.4.4
4	Advanced setting mode	Monitor Menu	Displays the temperature of the freezing circuit, pressure and ambient temperature(only air-cooled refrigerated type).	5.5.2
5		Standard setting menu	Set various setting values such as key lock, alarm buzzer sound, offset temperature, electric conductivity set value (in option DM).	5.5.3
6		Alarm setting menu	It sets the validity / invalidity of various alarms, switches WRN (operation continuation) / FTL (operation stop), and changes the alarm set value.	5.5.4
7		Communication setting menu	Set contact input / output and serial communication.	5.5.5
8		Reset menu	Initialize the setting data and reset the maintenance time.	5.5.6
9		Information monitor menu	The model and program version of this product are displayed. Displays the operation cumulative time, pump operation cumulative time, cumulative freezer operation cumulative time, fan operation cumulative time, dust filter use time, and DI filter usage time for this product.	5.5.7
10		Alarm history menu	The alarm number that occurred in the past and the operation total time when an alarm occurred are displayed. (Up to 150 records will be recorded.)	5.5.8

5.2 Function

5.2.1 Key operations

The key operation of this product is shown in Fig 5 -1 Key operation list (1/4) to Fig 5-4 Key operation list (4/4).

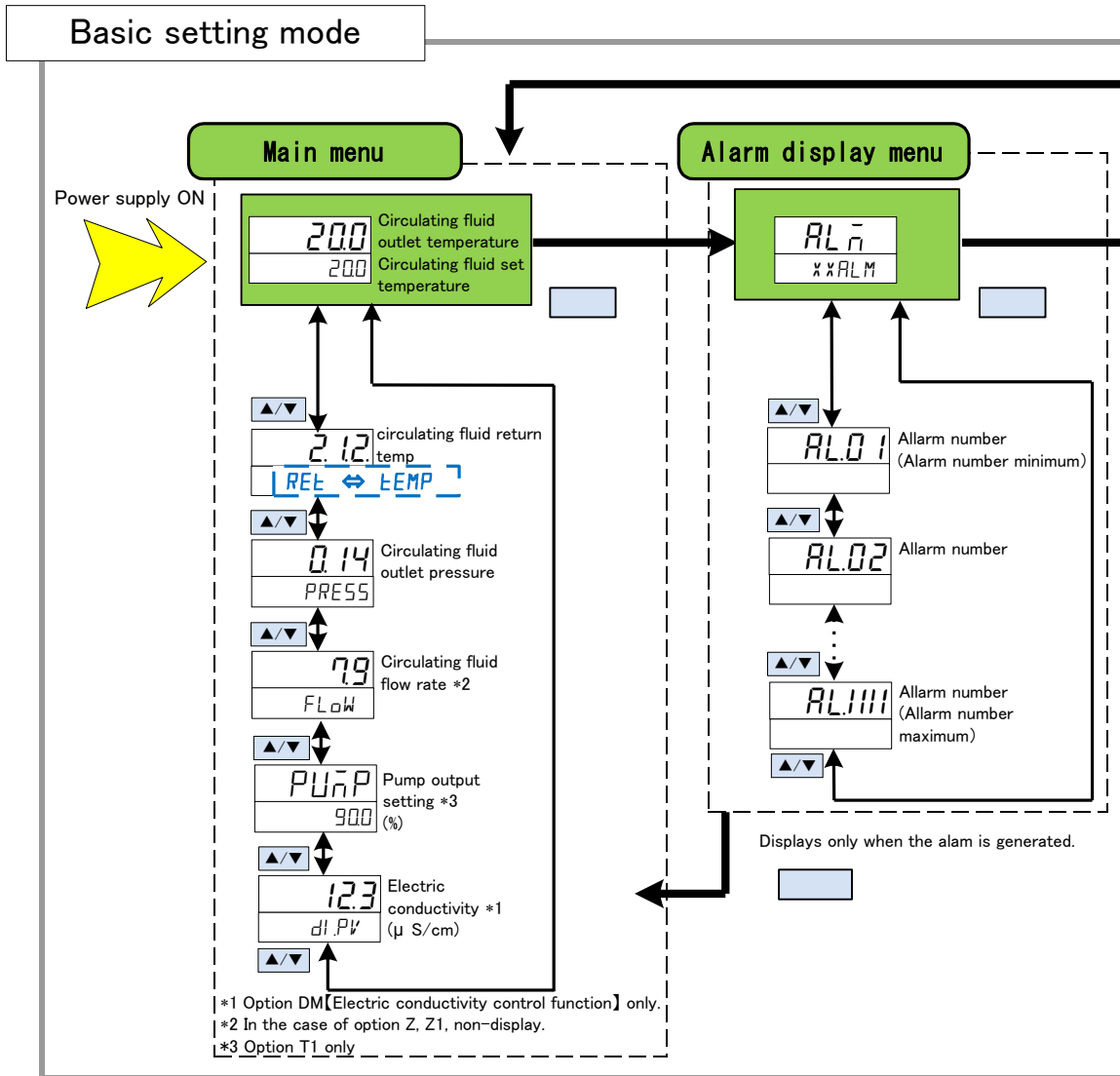

Fig 5-1 Key operation (1/4)

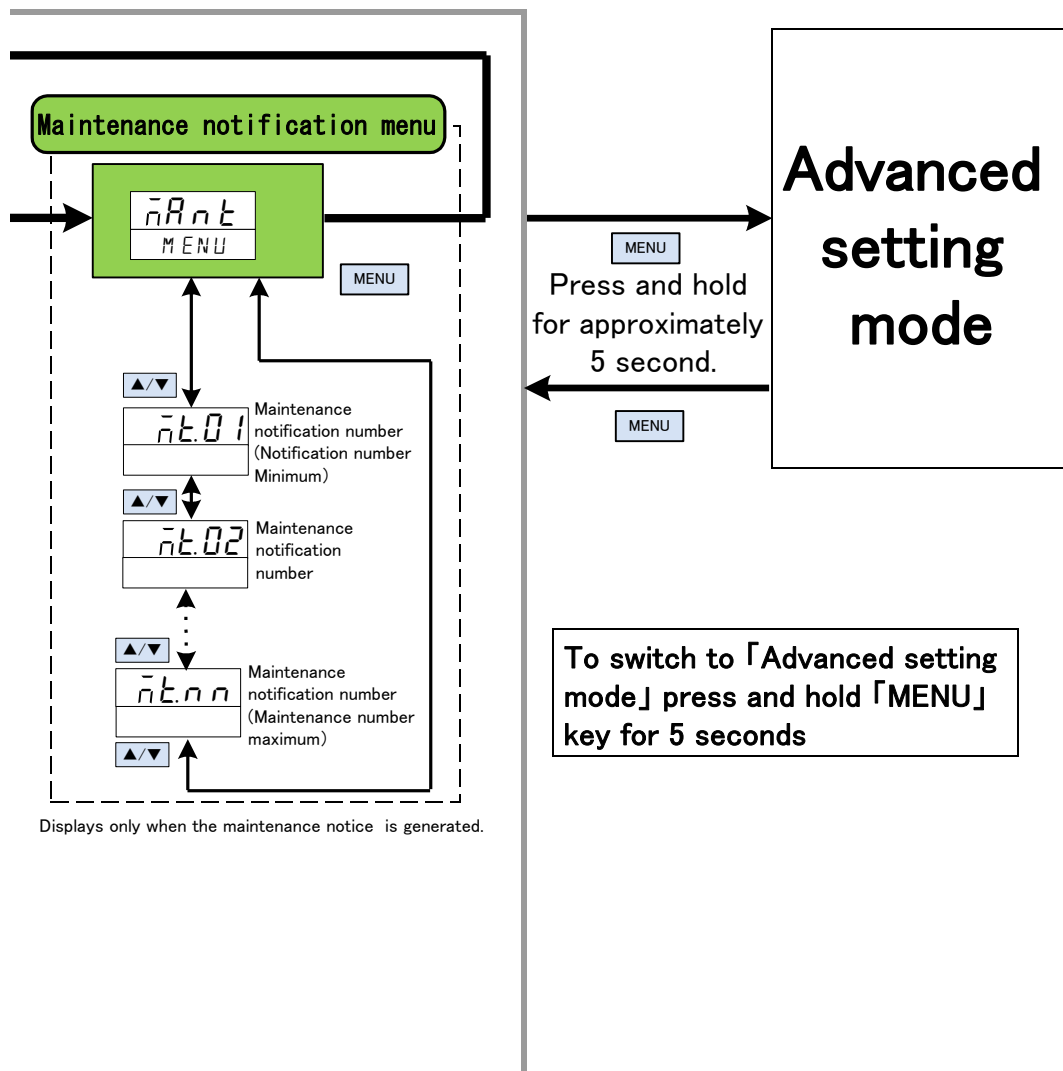

Fig 5-2 Key operation (2/4)

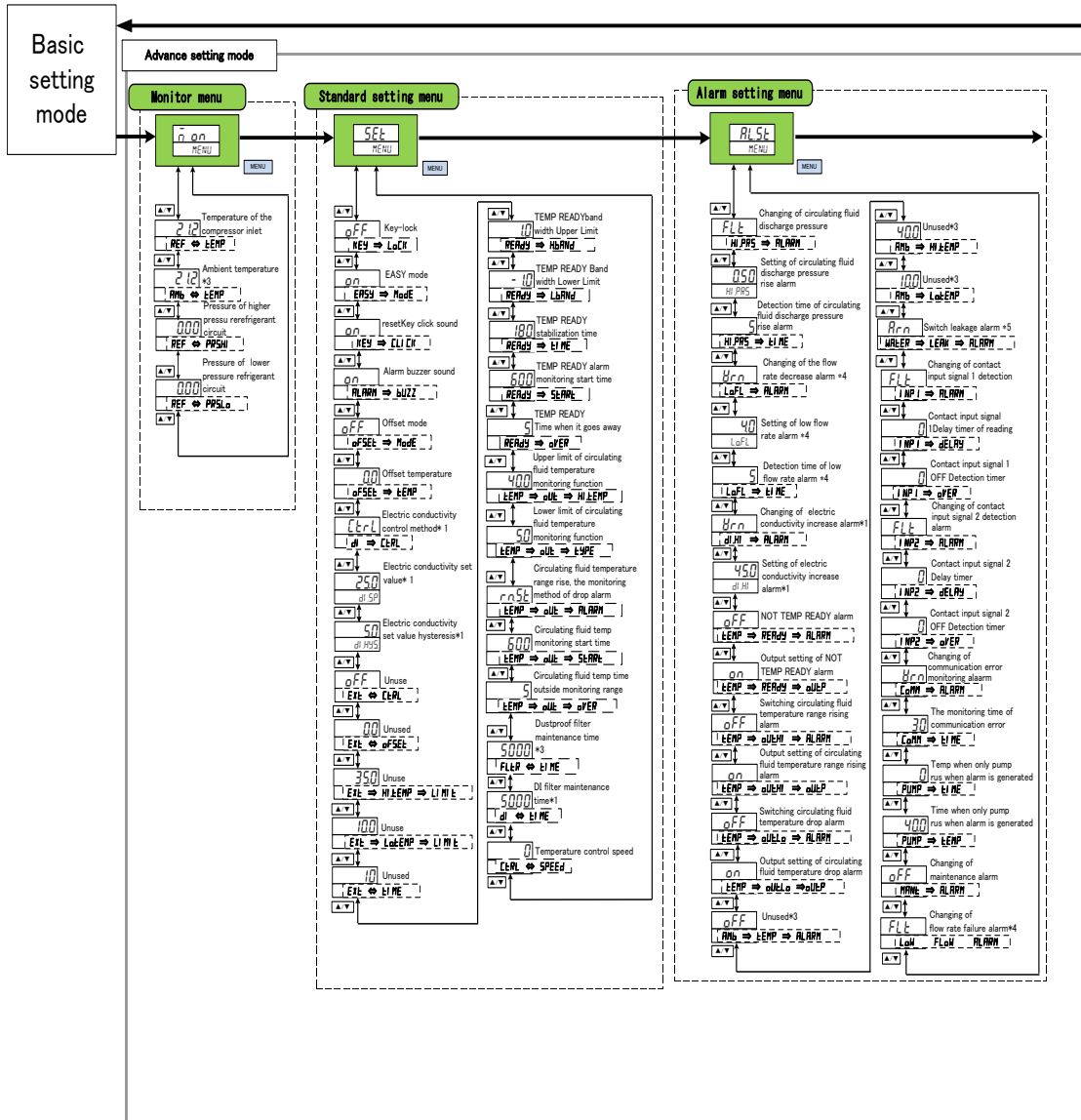

Fig 5-3 Key operation (3/4)

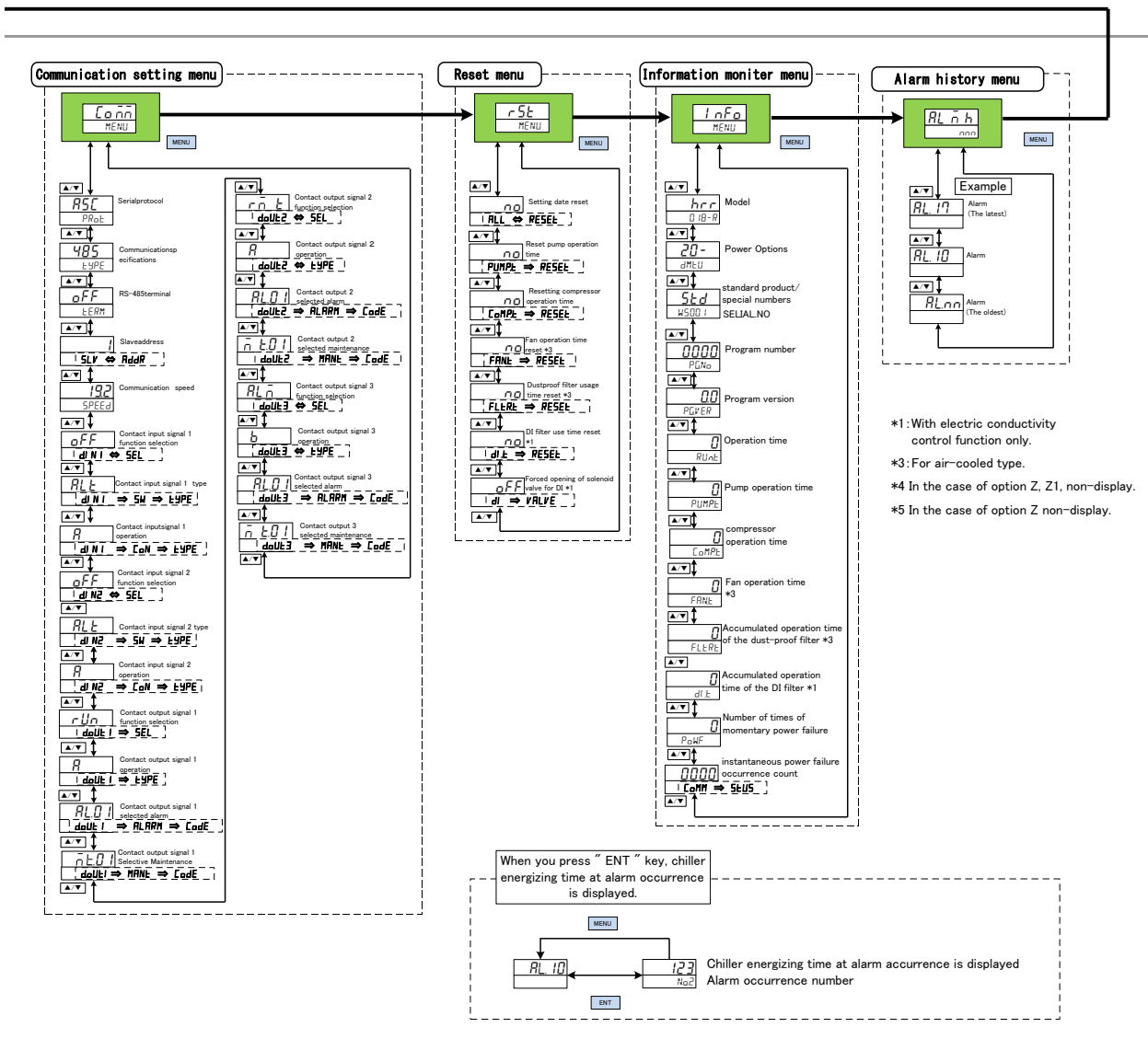

Fig 5-4 Key operation (4/4)

5.3 List of parameters

The parameter list of this product is shown below.

5.3.1 Main Menu

Table 5.3-1 Main menu parameter list

ScreenNo.	Display unit		Unit display	Initial value (Default setting)	Reference page
	Upper stage (White)	Lower stage (Green)			
TOP screen	circulating fluid outlet temperature (Present value)	Circulating fluid set temperature	°C	20.0	5.4.2
No.1 screen	Circulating fluid return temp.	RET ⇄ TEMP	°C	-	
No.2 screen	Circulating fluid discharge pressure	PRESS	MPa	-	
No.3 screen	Circulating fluid flow *1	FLOW	LPM	-	
No.4 screen	PUMP	Pump output set value *2	%	90.0	
No.5 screen	Electric conductivity *3	DI.PV	-	-	

*1 Not displayed for options Z and Z1.

*2 Displayed when option T1 is selected.

*2 Displayed when option DM (Electric conductivity control function, DI water (pure water) piping) is selected.

5.3.2 Alarm display menu

Table 5.3-2 Alarm display menu parameter list

TOP screen	Display unit		Reference page
	Upper stage (White)	Lower stage (Green)	
TOP screen	ALM	*ALM	5.4.3
No.1 screen	AL01	LOW⇒LEVEL⇒FLT	
No.2 screen	AL02	LOW⇒LEVEL⇒WRN	
.	.	.	
.	.	.	

*Displays the number of alarms currently occurring.

If an alarm has not occurred, this menu will not be displayed.

5.3.3 Notice for maintenance Menu

Table 5.3-3 Notice for maintenance Menu Parameter List

TOP screen	Display unit		Reference page
	Upper stage (White)	Lower stage (Green)	
TOP screen	MANT	MENU	5.4.4
No.1 screen	MT01	PUMP	
No.2 screen	MT04	FLTR	
.	.	.	
.	.	.	

*Displays the content of notice for maintenance currently occurring.

This menu will not be displayed if notice for maintenance has not occurred.

5.3.4 Monitor Menu

Table 5.3-4 Monitor menu parameter list

ScreenNo.	Display unit		Unit display	Reference page
	Upper stage (White)	Lower stage (Green)		
TOP screen	MON	MENU	—	5.5.2
No.1 screen	Temperature of the compressor inlet	REF⇒TEMP	°C	
No.2 screen	Ambient temperature *1	AMB⇒TEMP	°C	
No.3 screen	Pressure of higher pressure refrigerant circuit	REF⇒PRS.HI	MPa	
No.4 screen	Pressure of lower pressure refrigerant circuit	REF⇒PRS.LO	MPa	

*1 Only displayed on air-cooled type.

5.3.5 Standard setting menu

Table 5.3-5 Standard setting menu parameter list

ScreenNo.	Item	Display unit			Unit display	Reference page
		Upper stage (White)		Lower stage (Green)		
		Initial value	Select/setting range			
TOP screen	—	SET	—	MENU	—	5.5.3
No.1 screen	Key-lock	OFF	OFF/ON	KEY⇒LOCK	—	
No.2 screen	Basic setting mode	ON	OFF/ON	EASY⇒MODE	—	
No.3 screen	Key click sound	ON	OFF/ON	KEY⇒CLICK	—	
No.4 screen	Alarm buzzer	ON	OFF/ON	ALARM⇒BUZZ	—	
No.5 screen	Offset mode	OFF	OFF/MD1/MD2/MD3	OFSET⇒MODE	—	
No.6 screen	Offset temperature	0.0	-20.0 to 20.0	OFSET⇒TEMP	°C	
No.7 screen	Electric conductivity control *1	Ctrl	Ctrl/OPEN/CLSE	DI⇒Ctrl	—	
No.8 screen	Electric conductivity setting value (μS/cm)*1	25.0	0.5 to 45.0	DI.SP	—	
No.9 screen	Electric conductivity Hysteresis setting value (μS/cm)*1	5.0	0.1 to 10.0	DI.HYS	—	
No.10 screen	Unused	OFF	—	EXT⇒Ctrl	—	
No.11 screen	Unused	0.0	—	EXT⇒OFSET	°C	
No.12 screen	Unused	35.0	—	EXT⇒HI.TEMP⇒LIMIT	°C	
No.13 screen	Unused	10.0	—	EXT⇒LO.TEMP⇒LIMIT	°C	
No.14 screen	Unused	10	—	EXT⇒TIME	SEC	
No.15 screen	TEMP READY bandwidth upper limit	1.0	0.1 to 9.9	READY⇒H.BAND	°C	
No.16 screen	TEMP READY bandwidth lower limit	-1.0	-9.9 to -0.1	READY⇒L.BAND	°C	
No.17 screen	TEMP READY stability time	180	10 to 9999	READY⇒TIME	SEC	
No.18 screen	TEMP READY alarm of monitoring start time	600	0 to 9999	READY⇒START	SEC	
No.19 screen	Time TEMP READY remove	5	0 to 600	TEMP⇒READY	SEC	
No.20 screen	Upper limit of circulating fluid temperature monitor	40.0	5.0 to 45.0	TEMP⇒OUT⇒HI.TEMP	°C	
No.21 screen	Lower limit of circulating fluid temperature monitor	5.0	1.0 to 40.0	TEMP⇒OUT⇒LO.TEMP	°C	
No.22 screen	Monitor circulating fluid temperature rise / drop alarm	rn.st	rn.st/PW.on	TEMP⇒OUT⇒ALARM	—	
No.23 screen	Start time of circulating fluid temperature monitor	600	0 to 9999	TEMP⇒OUT⇒START	SEC	
No.24 screen	circulating fluid temperature monitor is outside of the time range	5	0 to 600	TEMP⇒OUT⇒OVER	SEC	
No.25 screen	Dust filter replacement time*2	5000	1 to 9999	FLTR⇒TIME	H	
No.26 screen	DI filter replacement time*1	5000	1 to 9999	DI⇒TIME	H	
No.27 screen	Temperature control speed	0	-10 to 10	CTRL⇒SPEED	—	

*1 Can only be set with option DM (Electric conductivity control function, DI water (pure water) piping).

*2 Can only be set with air-cooled type.

5.3.6 Alarm Setting Menu

Table 5.3-6 Alarm setting menu Parameter list

ScreenNo.	Item	Display unit			Unit display
		Upper stage (White)		Lower stage (Green)	
		Initial value	Select/setting range		
TOP screen	—	AL.ST	—	MENU	—
No.1 screen	Changing of "AL09: Circulating fluid discharge pressure rise"	FLT	WRN/FLT	HI.PRS⇒ALARM	—
No.2 screen	Setting for "AL09: Circulating fluid discharge temperature rise"	0.5 0.40 *5	0.05 to 0.50 0.05 to 0.45 *5	HI.PRS	MPa
No.3 screen	Detection time for "AL09: Circulating fluid discharge temperature rise"	5	0 to 60	HI.PRS⇒TIME	SEC
No.4 screen	Changing of "AL10: Lower flow rate" *3	WRN	OFF/WRN/FLT	LO.FL⇒ALARM	—
No.5 screen	Setting for "AL10: Lower flow rate" *3	4.0	2.0 to 15.0	LO.FL	LPM
No.6 screen	Detection time for "AL10: Lower flow rate" *3	5	0 to 600	LO.FL⇒TIME	SEC
No.7 screen	Changing of "AL12: Electric conductivity control pressure rise alarm" (μS/cm) *1	WRN	OFF/WRN	DI.HI⇒ALARM	—
No.8 screen	Setting for "AL12: Electric conductivity control pressure rise alarm" (μS/cm) *1	45.0	0.4 to 46.0	DI.HI	—
No.9 screen	Changing of "AL.13: NOT TEMP READY alarm"	OFF	OFF/WRN/FLT	TEMP⇒READY⇒ALARM	—
No.10 screen	Output setting of "AL.13: NOT TEMP READY alarm"	ON	OFF/ON	TEMP⇒READY⇒OUT.P	—
No.11 screen	Changing of "AL14: Circulating fluid temperature rise alarm"	OFF	OFF/WRN/FLT	TEMP⇒OUT.HI⇒ALARM	—
No.12 screen	output setting of "AL14: Circulating fluid temperature rise alarm"	ON	OFF/ON	TEMP⇒OUT.HI⇒OUT.P	—
No.13 screen	Changing of "AL15: Circulating fluid temperature drop"	OFF	OFF/WRN/FLT	TEMP⇒OUT.LO⇒ALARM	—
No.14 screen	Output setting of "AL15: Circulating fluid temperature drop"	ON	OFF/ON	TEMP⇒OUT.LO⇒OUT.P	—
No.15 screen	Changing of "AL11: Ambient temperature out of range alarm" *2	OFF	OFF/WRN/FLT	AMB⇒TEMP⇒ALARM	—
No.16 screen	Upper limit of "AL11: Ambient temperature out of range alarm" *2	40.0	10.0 to 45.0	AMB⇒HI.TEMP	°C
No.17 screen	Lower limit "AL11: Ambient temperature out of range alarm" *2	10.0	5.0 to 40.0	AMB⇒LO.TEMP	°C
No.18 screen	Changing of "AL04: Water leakage" *4	WRN	OFF/WRN/FLT	WATER⇒LEAK⇒ALARM	—
No.19 screen	Changing of "AL25: Contact input signal detection 1"	FLT	OFF/WRN/FLT	INP1⇒ALARM	—
No.20 screen	"AL25: Contact input signal detection 1" reading delay timer	0	0 to 300	INP1⇒DELAY	SEC
No.21 screen	"AL25: Contact input signal detection 1" OFF detection timer	0	0 to 10	INP1⇒OVER	SEC
No.22 screen	Changing of "AL26: Contact input signal detection 2"	FLT	OFF/WRN/FLT	INP2⇒ALARM	—
No.23 screen	"AL26: Contact input signal detection 2" reading delay timer	0	0 to 300	INP2⇒DELAY	SEC
No.24 screen	"AL26: Contact input signal detection 2" OFF detection timer	0	0 to 10	INP2⇒OVER	SEC
No.25 screen	Changing of "AL29: Communication error alarm"	WRN	OFF/WRN/FLT	COMM⇒ALARM	—
No.26 screen	Detection time for "AL29: Communication error alarm"	30	1 to 600	COMM⇒TIME	SEC
No.27 screen	Only when the abnormality occurs Pump operation possible time	0.0	0 to 9999	PUMP⇒TIME	SEC
No.28 screen	Only when the abnormality occurs Pump only possible operation temperature	40.0	5.0 to 45.0	PUMP⇒TEMP	°C
No.29 screen	Switch maintenance notification	OFF	OFF/WRN/FLT	MANT⇒ALARM	—
No.30 screen	Changing of "AL17: Flow rate failure alarm" *3	FLT	OFF/WRN/FLT	LOW⇒FLOW⇒ALARM	—

*1 Can only be set with option DM(Electric conductivity control function,DI water (pure water) piping).

*2 Can only be set with air-cooled type.

*3 Not displayed for options Z and Z1.

*4 Not displayed for option Z.

*5 For option T1.

5.3.7 Communication setting menu

Table 5.3-7 Communication setting menu Parameter list

ScreenNo.	Item	Display unit			Reference page
		Upper stage (White)		Lower stage (Green)	
		Initial value	Select/setting range		
TOP screen	—	COMM	—	MENU	5.5.5
No.1 screen	Serial protocol	ASC	ASC/RTU	PROT	
No.2 screen	Communication specifications	485	485/232C	TYPE	
No.3 screen	RS-485 terminal	OFF	OFF/ON	TERM	
No.4 screen	Slave address	1	1~32	SLV ⇒ ADDR	
No.5 screen	Communication speed (bps)	19.2	9.6/19.2	SPEED	
No.6 screen	Contact input signal 1 function	OFF	OFF/RN.ST/RUN/SW	D.IN1 ⇒ SEL	
No.7 screen	Contact input signal 1 type	ALT	ALT/MT	D.IN1 ⇒ SW ⇒ TYPE	
No.8 screen	Contact input signal 1 operation	A	A/B	D.IN1 ⇒ CON ⇒ TYPE	
No.9 screen	Contact input signal 2 function	OFF	OFF/STOP/SW	D.IN2 ⇒ SEL	
No.10 screen	Contact input signal 2 type	ALT	ALT/MT	D.IN2 ⇒ SW ⇒ TYPE	
No.11 screen	Contact input signal 2 operation	A	A/B	D.IN2 ⇒ CON ⇒ TYPE	
No.12 screen	Contact output signal 1 function	RUN	※1	D.OUT1 ⇒ SEL	
No.13 screen	Contact output signal 1 operation	A	A/B	D.OUT1 ⇒ TYPE	
No.14 screen	Contact output signal 1 alarm	AL01	AL01~AL32	D.OUT1 ⇒ ALARM ⇒ CODE	
No.15 screen	Contact output signal 1 maintenance	MT.01	MT.01~MT.05	D.OUT1 ⇒ MANT ⇒ CODE	
No.16 screen	Contact output signal 2 function	RMT	※1	D.OUT2 ⇒ SEL	
No.17 screen	Contact output signal 2 operation	A	A/B	D.OUT2 ⇒ TYPE	
No.18 screen	Contact output signal 2 alarm	AL01	AL01~AL32	D.OUT2 ⇒ ALARM ⇒ CODE	
No.19 screen	Contact output signal 2 maintenance	MT.01	MT.01~MT.05	D.OUT2 ⇒ MANT ⇒ CODE	
No.20 screen	Contact output signal 3 function	ALM	※1	D.OUT3 ⇒ SEL	
No.21 screen	Contact output signal 3 operation	B	A/B	D.OUT3 ⇒ TYPE	
No.22 screen	Contact output signal 3 alarm	AL01	AL01~AL32	D.OUT3 ⇒ ALARM ⇒ CODE	
No.23 screen	Contact output signal 3 maintenance	MT.01	MT.01~MT.05	D.OUT3 ⇒ MANT ⇒ CODE	

*1 : OFF/RUN/RMT/EXT.C/RDY/T.OUT/FLT/WRN/MENT/
 Selectable from ALM/SW1/SW2/A.SEL/M.SEL

5.3.8 Reset menu

Table 5.3-8 Reset menu parameter list

ScreenNo.	Item	Display unit			Reference page
		Upper stage (White)		Lower stage (Green)	
		Initial value	Select/setting range		
TOP screen	—	RST	—	MENU	5.5.6
No.1 screen	Setting data reset	NO	NO/YES	ALL⇒RESET	
No.2 screen	Reset pump operation time	NO	NO/YES	PUMP.T⇒RESET	
No.3 screen	Resetting compressor operation time	NO	NO/YES	COMP.T⇒RESET	
No.4 screen	Resetting fan operation time *1	NO	NO/YES	FAN.T⇒RESET	
No.5 screen	Dustproof filter use time reset *1	NO	NO/YES	FLTR.T⇒RESET	
No.6 screen	DI filter use time reset *2	NO	NO/YES	DI.T⇒RESET	
No.7 screen	Solenoid valve for electric conductivity control Forced OPEN *2	OFF	OFF/ON	DI⇒VALVE	

*1 Can only be set with air-cooled type.

*2 Can only be set with option DM (Electric conductivity control function, DI water (pure water) piping).

5.3.9 Information Monitor Setting Menu

Table 5.3-9 Information monitor setting menu Parameter list

ScreenNo.	Item	Display unit		Unit display	Reference page
		Upper stage (White)	Lower stage (Green)		
TOP screen	—	INFO	MENU	—	5.5.7
No.1 screen	Model Cooling capacity / method	HRR	XXXXXX	—	
No.2 screen	Model Power supply / Options	20	-DMTUYZ	—	
No.3 screen	Standard / Special product number	5 d d or x00 i	Serial No.	—	
No.4 screen	Program number	Program number	PG.NO	—	
No.5 screen	Program version	Program version	PG.VER	—	
No.6 screen	Thermo-chiller accumulated operation time	Display in the range of 0 to 1,000,000	RUN.T	H	
No.7 screen	Accumulated operation time of pump	Display in the range of 0 to 1,000,000	PUMP.T	H	
No.8 screen	Accumulated operation time of compressor	Display in the range of 0 to 1,000,000	COMP.T	H	
No.9 screen	Accumulated operation time of fan	Display in the range of 0 to 1,000,000	FAN.T	H	
No.10 screen	Used time of dust filter *1	Display in the range of 0 to 1,000,000	FLTR.T	H	
No.11 screen	Used time of DI filter *2	Display in the range of 0 to 1,000,000	DI.T	H	
No.12 screen	Instantaneous power failure occurrence count	Display in the range of 0 to 1,000,000	POW.F	—	
No.13 screen	Serial communication status	Display at 0 to FFFF	COMM⇒SEUS	—	

*1 Only displayed on air-cooled type.

*2 Displayed when option DM (Electric conductivity control function, DI water (pure water) piping).

5.4 Basic setting mode

5.4.1 Screen configuration

The screen of this product shows "basic setting mode" and "advanced setting mode".

In "basic setting mode", only temperature can be set. Other settings are done in "advanced setting mode". "Basic setting mode" consists of the following menu.

- Main menu
- Alarm display menu
- Notice for maintenance menu

5.4.2 Main menu

The display on the main screen is as follows.

Current discharge temperature of circulating fluid (Main menu TOP screen)

- 1.** Turn ON the power supply switch.
 Current temperature and set temperature are displayed on the digital display.
 * Alarm display screen (See 5.4.3) appears when an alarm is generated.

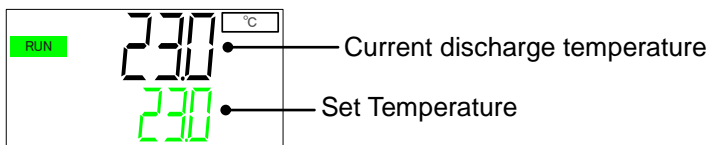

Circulating fluid temperature setting

- 2.** Press the [ENT] key, the set temperature will blink and the set value can be changed. Change the set temperature by pressing the [▼][▲] key. After changing the set temperature, set it by pressing the [ENT] key. After setting the value, blinking will end.

Circulating fluid return temperature Display

- 3.** Press the [▼] key.
 The return temperature of the circulating fluid is displayed on the digital display.

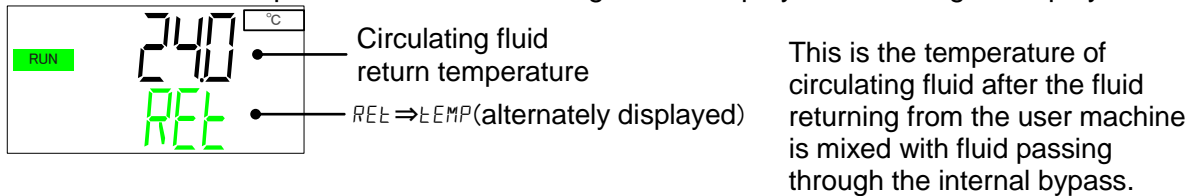

Circulating fluid discharge pressure display

- 4.** Press the [▼] key.
 The discharge pressure of the circulating fluid is displayed on the digital display.

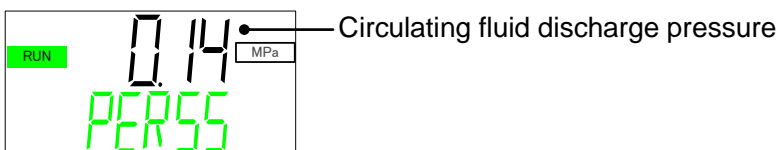

Circulating fluid flow display

- 5.** Press the [▼] key.
The circulating fluid flow rate is displayed on the digital display.
(Not displayed for options Z and Z1.)



Circulating fluid flow The display flow rate does not include the circulating fluid flow rate flowing in the bypass of this product.

Pump output set value display

- 6.** Press the [▼] key.
The inverter pump output set value is displayed on the digital display.
(Only for option T1 [Inverter pump mounted])



Pump output set value (setting range : 60.0 to 100.0%)

Press the [ENT] key, the pump output set value will blink and the set value can be changed.

Change the set value by pressing the [▼][▲] key.

After changing the set value, set it by pressing the [ENT] key.

After setting the value, blinking will end.

(The factory default : 90.0%)

Electric conductivity display

- 7.** Press the [▼] key.
The electric conductivity is displayed on the digital display.
(Only for option DM [Electric conductivity control function, DI water (pure water) piping]) The unit is "μS / cm".



Electric conductivity

5.4.3 Alarm display menu

The alarm display menu appears when an alarm is generated. If an alarm has not occurred, this menu will not be displayed.

*For alarm contents, refer to Chapter 7 "Alarm notification and troubleshooting" .

*If the [MENU] key is pressed while an alarm is occurring, the TOP screen of the alarm display menu is displayed. When the [MENU] key is pressed while on the TOP screen of the alarm display menu, the next menu screen is displayed.

Alarm display menu TOP screen

1. On the TOP screen of the alarm display menu, the number of alarms currently occurring is displayed.

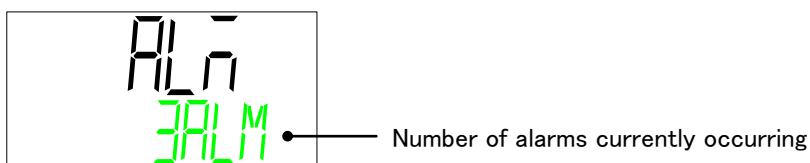

2. Press the [▼] key.
Displays the alarm numbers currently occurring in alarm number order.

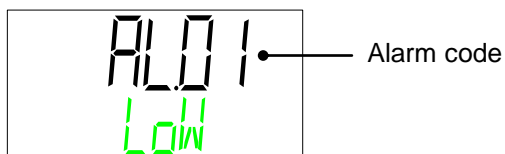

3. Press the [▼] key.
If more than one alarm has occurred, the next alarm number is displayed.

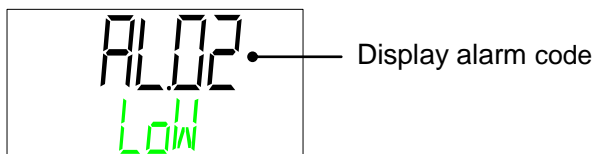

5.4.4 Notice for maintenance Menu

A notice for maintenance will occur when it is time to replace components such as pumps and fans.

In addition, if the usable time of the dust filter and the DI filter is set beforehand, a notice for maintenance will be generated when the usage time is reached.

When a notice for maintenance is generated, the notice for maintenance menu will be displayed.

*If notice for maintenance has not occurred, this menu will not be displayed.

*If the [MENU] key is pressed while a notice for maintenance is occurring, the notice for maintenance menu TOP screen is displayed. Press the [MENU] key while on the Notice for maintenance Menu TOP screen to switch to the next menu.

*To reset a notice for maintenance, refer to "5.5.6 Reset menu".

When a notice for maintenance is generated, "X" is displayed on the display panel.

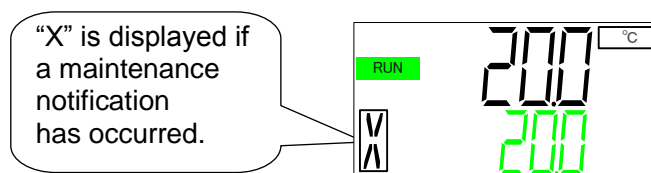

Table 5.4-1 shows the contents of the notice for maintenance number.

Table 5.4-1 Notice for maintenance list

No.	Contents	Generation time
MT.01	Notice for pump maintenance	Cumulative operation time: It occurs at 20,000 hours.
MT.02	Notice for compressor maintenance	Cumulative operation time: It occurs at 60,000 hours.
MT.03	Notice for fan maintenance * 1	Cumulative operation time: It occurs at 20,000 hours.
MT.04	Notice of dust-proof filter Maintenance * 1	Cumulative use time: It occurs at 5,000 hours. (It can be changed within the range of 1 to 9999 hour)
MT.05	Notice of DI filter maintenance * 2	Cumulative use time: It occurs at 5,000 hours. (It can be changed within the range of 1 to 9999 hour)

*1 : For air-cooled type

*2 : Option DM [Electric conductivity control function, DI water (pure water) piping] only

Notice for maintenance menu TOP screen

1. This is the TOP screen of the notice for maintenance menu.

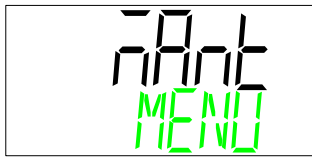

2. Press the [▼] key.
Displays the notice for maintenance number currently occurring in order of maintenance notification number.

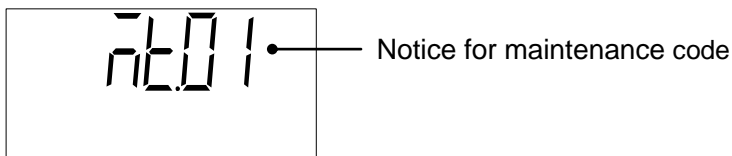

3. Press the [▼] key.
If more than one notice for maintenance has occurred, the next notice for maintenance number will be displayed.

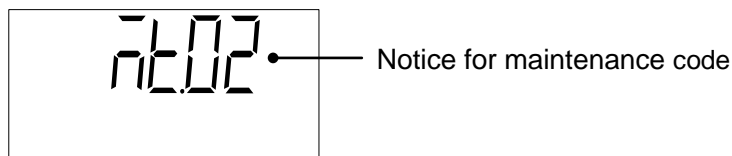

5.5 Advanced setting mode

5.5.1 Switch to advanced setting mode

Settings other than circulating fluid temperature setting are performed in "Advanced setting mode".

While displaying the main menu TOP screen of "Basic setting mode"

Press and hold the [MENU] key for 5 seconds to switch to "Advanced setting mode".

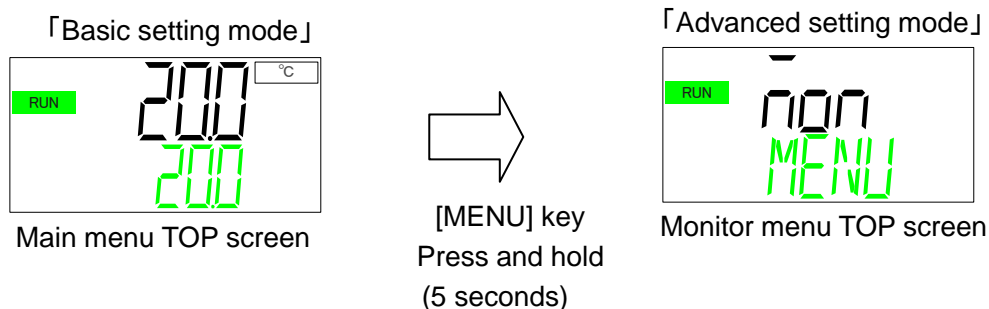

"Advanced setting mode" is composed of the following menu.

- Monitor Menu
- Standard setting menu
- Alarm setting menu
- Communication setting menu
- Reset menu
- Information Monitor Menu
- Alarm history menu

5.5.2 Display contents of monitor menu

The following sensor values not displayed in "Main Menu" of this product are displayed.

- Temperature at the inlet of the compressor
- Ambient temperature
- Pressure of high pressure refrigerant circuit
- Pressure of low pressure refrigerant circuit

Monitor menu TOP screen

1. Press and hold the [MENU] key for 5 seconds from the main menu display state to switch to the monitor menu TOP screen.



Monitor menu TOP screen

Temperature at the compressor inlet.

- 2.** Press the [▼] key. Displays temperature at the compressor inlet.

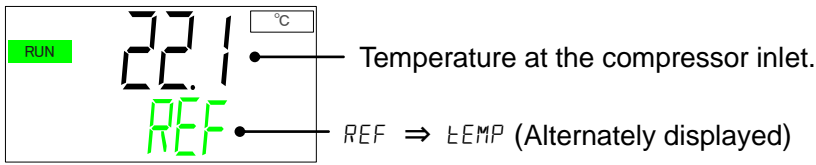

Ambient temperature

- 3.** Press the [▼] key. Displays the ambient temperature (ventilated air temperature of this product).
 (Displayed only for air-cooled type.)

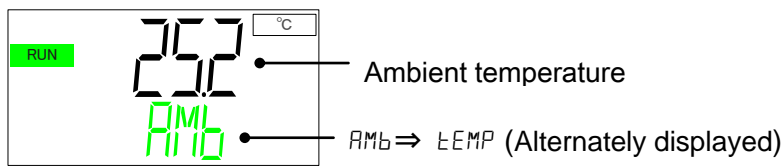

Pressure of high pressure refrigerant circuit

- 4.** Press the [▼] key. Displays pressure of high pressure refrigerant circuit

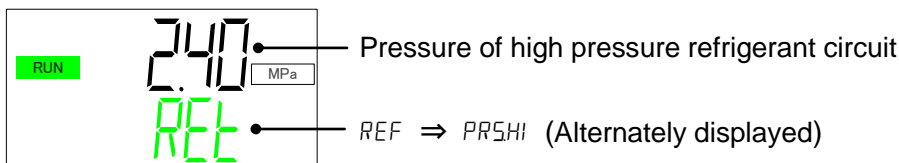

Pressure of low pressure refrigerant circuit

- 5.** Press the [▼] key. Displays pressure of low pressure refrigerant circuit

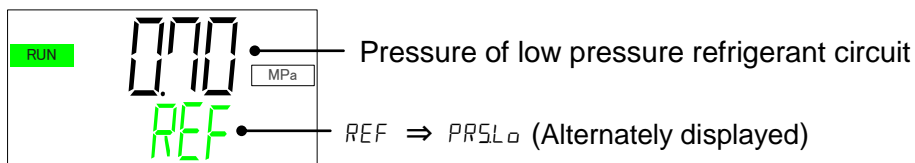

5.5.3 Display contents of the standard setting menu

Perform settings other than temperature setting.

Standard menu TOP screen

1. When the [MENU] key is pressed while the monitor menu TOP screen is displayed the screen switches to the "Standard setting menu TOP screen".

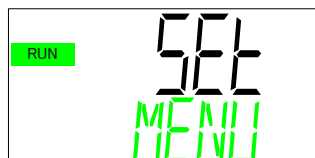

Standard setting menu TOP screen

Key-lock

2. Press the [▼] key. Displays key lock setting screen.



oFF : Key lock invalid / oN : Key lock active

KEY ⇒ LoCK (Alternately displayed)

■ Key-lock

This function prevents changing of the setting value. Depending on the [RUN / STOP] key operation start / stop is possible.

To activate the key lock, press the [ENT] key. "OFF" indication flashes. If you press the [▼] key while it is flashing, it switches to the "On" display. Pressing the [ENT] key terminates the flashing and activates the key lock.

EASY mode

3. Press the [▼] key. Displays EASYmode setting screen.



oN : EASY mode enabled / oFF : EASY mode disabled

EASY ⇒ MoDE (Alternately displayed)

■ EASY mode

EASY mode is a function that easily displays only the "Basic setting mode" that is often used. The initial value is "EASY mode: ON".

In the EASY mode, switching to "Advanced setting mode" requires pressing the [MENU] key for 5 seconds.

When EASY mode set to OFF, a short press of the [MENU] key selects "Advanced setting mode".

To disable EASY mode, press the [ENT] key. "ON" flashes.
Pressing the [▼] key while flashing will switch to the "OFF".
When the [ENT] key is pressed, the flashing ends and the EASY mode is disabled.

Key click sound

4. Press the [▼] key. Displays key click setting screen.

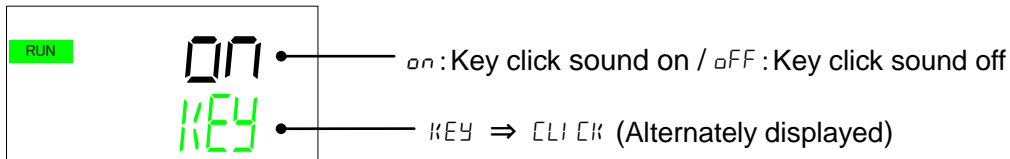

- Key click sound
Sets whether to hear a confirmation sound when pressing a key or not.
The initial setting has key click sound on.

To cancel the key click sound, press the [ENT] key.
"ON" indication flashes. Pressing the [▼] key while flashing will switch to "OFF".
When the [ENT] key is pressed, the flashing ends and the key click sound turns OFF.

Alarm buzzer sound

5. Press the [▼] key. Displays alarm buzzer sound setting screen.

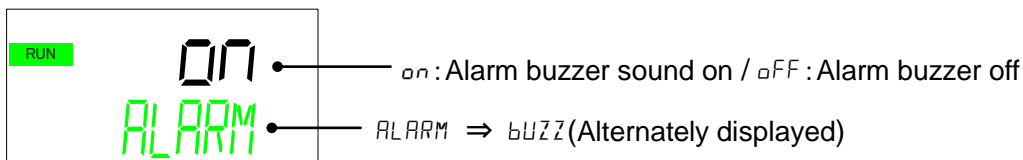

- Alarm buzzer sound
Sets whether generate an alarm sound when an alarm occurs or not.
The initial value is set to sound an alarm buzzer.

To turn off the alarm buzzer sound, press the [ENT] key. "ON" display flashes.
Pressing the [▼] key while flashing will switch to "OFF".
When the [ENT] key is pressed, the flashing ends and the alarm buzzer sound turns OFF.

Offset mode

6. Press the [▼] key. Displays offset mode setting screen.

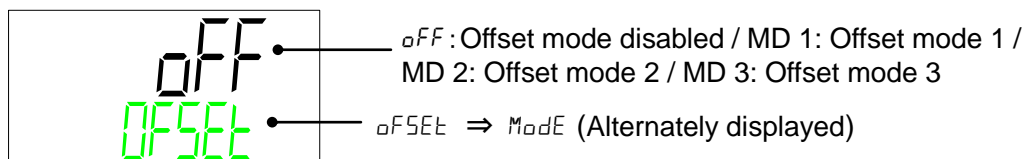

■ Offset function

This function controls the circulating fluid discharge temperature with offset.

Temperature offset may occur between the thermo-chiller and the customer's device depending on the installation environment. To correct the temperature offset, three types of offset functions are available (MODE1 to 3). The default setting of this function is "OFF".

【When communication is used】

The circulating fluid temperature sent by serial communication is the circulating fluid temperature which is displayed on the thermo-chiller (the circulating fluid temperature after offset).

● Example of temperature offset

The discharge temperature of the circulating fluid is 30°C, but the fluid temperature in the customer's device is 29°C because of heat radiation during sending of the fluid.

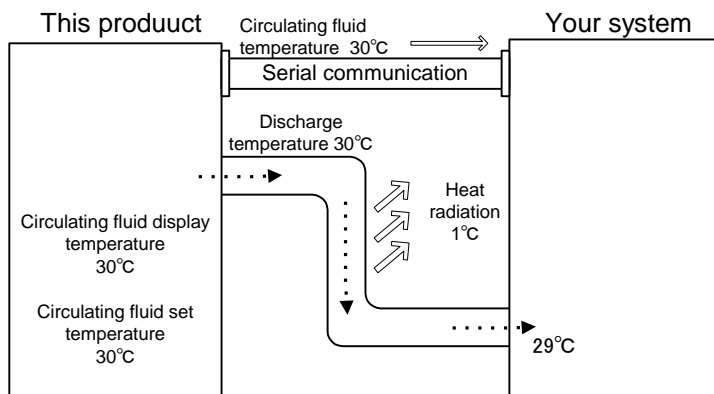

MODE	Explanation
MODE1	Control the temperature so that the discharge temperature of the circulating fluid is circulating fluid set temperature + offset temperature. Circulating fluid temperature indicates the circulating fluid discharge temperature.
MODE2	Control the temperature so that the discharge temperature of the circulating fluid is circulating fluid set temperature. Circulating fluid temperature indicates the circulating fluid discharge temperature + offset temperature.
MODE3	Control the temperature so that the discharge temperature of the circulating fluid is circulating fluid set temperature + offset temperature. Circulating fluid temperature indicates the circulating fluid discharge temperature - offset temperature.
OFF	Control the temperature so that the discharge temperature of the circulating fluid is circulating fluid temperature set value.

■ Example of MODE 1

When the offset temperature is 1°C, the thermo-chiller controls the temperature at 31°C (circulating fluid set temperature + offset temperature.) Even if the discharge temperature is 31°C, the circulating fluid temperature is 30°C at the customer’s device because of 1°C of heat radiation during sending of the fluid. Circulating fluid display temperature and communication data is 31°C.

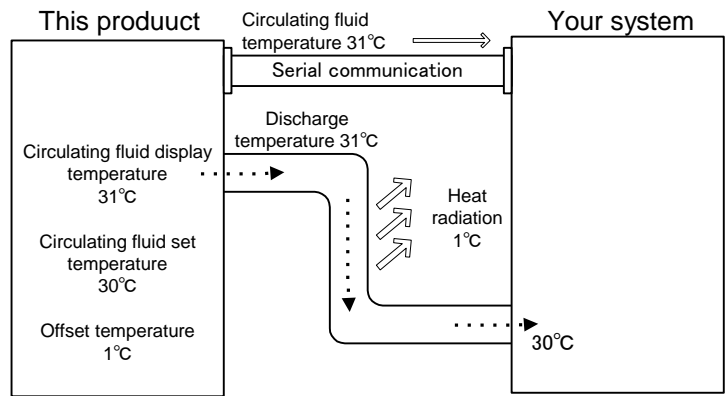

■ Example of MODE 2

When the offset temperature is -1°C, circulating fluid display temperature and the communication data is 29°C (circulating fluid discharge temperature + offset temperature), and matches the circulating fluid temperature at the customer’s device.

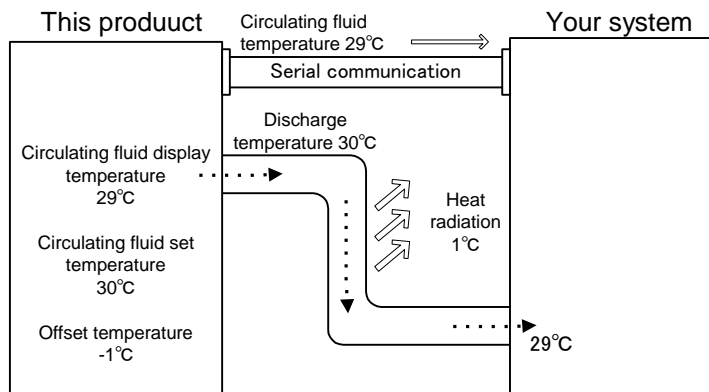

■ Example of MODE 3

When the offset temperature is 1°C, the thermo-chiller controls the temperature at 31°C (circulating fluid set temperature + offset temperature). Even if the discharge temperature is 31°C, the circulating fluid temperature is 30°C at the customer's device because of 1°C of heat radiation during sending of the fluid. The circulating fluid display temperature and the communication data is 30°C (circulating fluid discharge temp. - offset temp.), and matches the circulating fluid temperature at the customer's device.

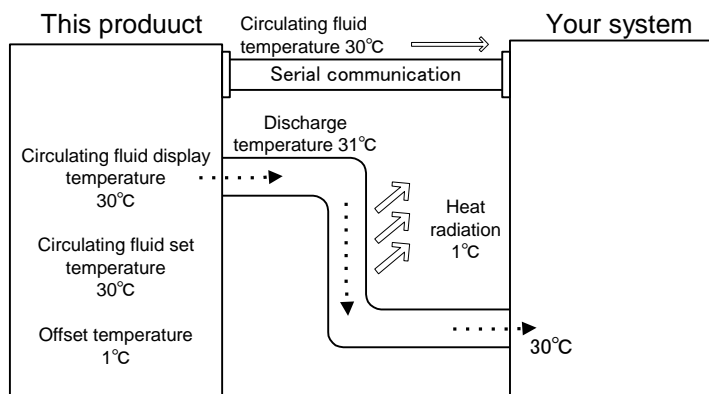

To switch the offset mode, press the [ENT] key. "OFF" flashes, press the [▲], [▼] key, select "OFF", "MD1", "MD2", "MD3" and confirm with [ENT] key.

Offset temperature

7. Press the [▼] key. Displays offset temperature setting screen.

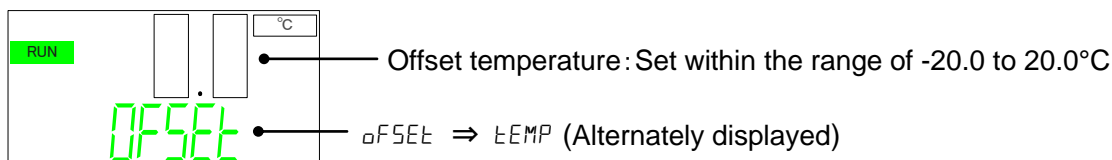

To change the offset temperature, press the [ENT] key. "0.0" flashes, press the [▲], [▼] key to change the offset temperature. When the [ENT] key is pressed, the flashing ends and the offset temperature is fixed.

⚠ CAUTION



- This function controls the offset temperature to the circulating fluid discharge temperature
- Control range of the circulating fluid temperature is 5.0°C to 35.0°C.
- When the circulating fluid temperature is set to 5.0°C and the offset temperature to -20.0°C, the offset temperature is automatically adjusted to 0.0°C (32.0°F) depending on the offset mode.

Electric conductivity control method

- 8.** Press the [▼] key. Displays electric conductivity control method setting screen.
 * Displayed only when option DM [Electric conductivity control function , DI water (pure water) piping] is selected.
 Without option DM, "8. Electric conductivity control method", "9. Electric conductivity set value", "10. Electric conductivity control hysteresis " are not displayed.

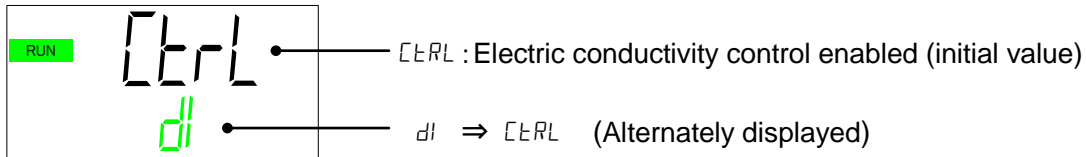

- Electric conductivity control method
 When option DM is selected, circulating fluid flows to the DI filter via a solenoid valve to control electric conductivity.
 This solenoid valve can be set to always OPEN, or always CLOSED.
 The factory setting is "CTRL: Electric conductivity control".
 By pressing the [▲], [▼] key, always OPEN, or always CLOSED can be set.

Selection item	Solenoid valve operation
<i>Ctrl</i>	The solenoid valve opens and closes to control the conductivity.
<i>oPEn</i>	Solenoid valve always open
<i>CLSE</i>	Solenoid valve always closed

Electric conductivity setting value

- 9.** Press the [▼] key. Displays electric conductivity setting value setting screen.
 * Displayed only when option DM [with electric conductivity control function , DI water (pure water) piping] is selected.

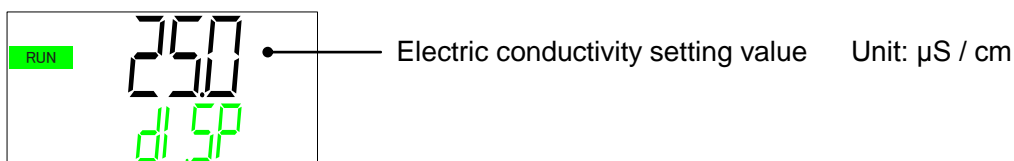

■ Electric conductivity setting value

The set value of electric conductivity can be set within the range of "0.5 to 45.0 $\mu\text{S} / \text{cm}$ ". The initial value is "25.0 $\mu\text{S} / \text{cm}$ ".

When the [ENT] key is pressed, the set value flashes. Press the [\blacktriangle], [\blacktriangledown] key to change the set value. When the [ENT] key is pressed, the flashing ends and the set value is confirmed.

Electric conductivity hysteresis

10. Press the [\blacktriangledown] key. Displays electric conductivity hysteresis setting screen.

* Displayed only when option DM [Electric conductivity control function , DI water (pure water) piping] is selected.

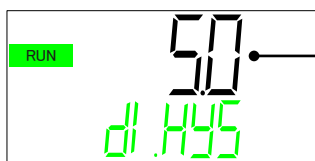

Electric conductivity control hysteresis set value Unit: $\mu\text{S} / \text{cm}$

■ Electric conductivity hysteresis

The electric conductivity control hysteresis can be set within a range of "0.1 to 10.0 $\mu\text{S} / \text{cm}$ ". The initial value is "5.0 $\mu\text{S} / \text{cm}$ ".

For the control image of electric conductivity by hysteresis, refer to "6.1 Option DM [Electric conductivity control function , DI water (pure water) piping].

To change the setting value, press the [ENT] key. Hysteresis set value flashes, press the [\blacktriangle], [\blacktriangledown] key to change the set value.

When the [ENT] key is pressed, the flashing ends and the set value is confirmed.

11. Press the [\blacktriangledown] key. Display as shown below. It is not used with this product.

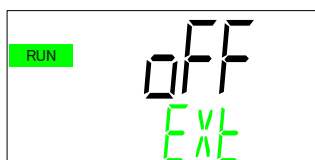

Unused

EXE \Rightarrow ERL (Alternately displayed)

12. Press the [\blacktriangledown] key. Display as shown below. It is not used with this product



Unused

EXE \Rightarrow OFSE (Alternately displayed)

13. Press the [▼] key. Display as shown below. It is not used with this product

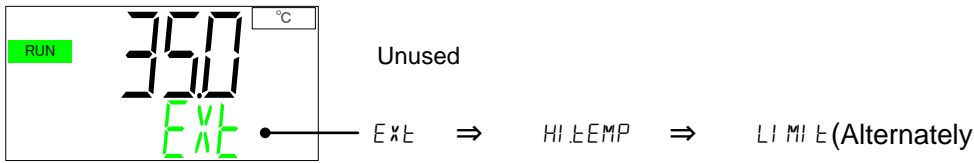

14. Press the [▼] key. Display as shown below. It is not used with this product

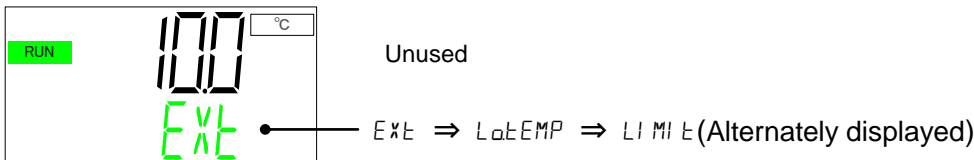

15. Press the [▼] key. Display as shown below. It is not used with this product

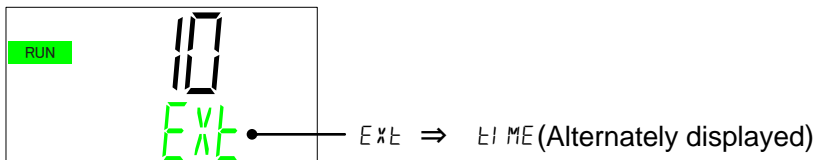

TEMP READY bandwidth upper limit

16. Press the [▼] key. Displays TEMP READY bandwidth upper limit setting screen.

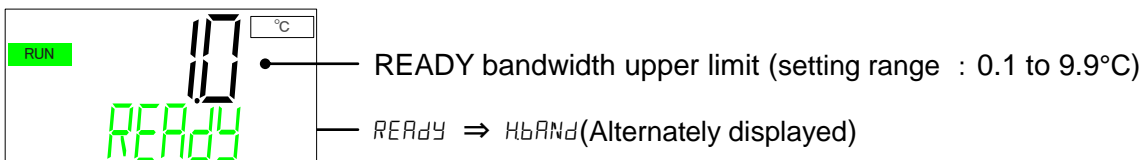

- Signal for completion of preparation (TEMP READY)
 This function sets the band width for the circulating fluid set temperature (upper/lower temperature range) in order to notify the customer by communication that the circulating fluid temperature has reached the band range (upper/lower temperature range). Alarms can also be assigned. Similar functions include TEMP OUT signal and NOT TEMP READY signal. Here is an example showing these relationships.

【TEMP READY function setting example】

- [1] Circulating fluid temperature at start of operation: about 20 ° C
- [2] Circulating fluid setting temperature: 15 ° C
- [3] "TEMP READY Bandwidth (Upper Limit)": Set to "2.0 ° C".
- [4] "TEMP READY Bandwidth (Lower Limit)": Set to "-2.0 ° C".
- [5] "TEMP READY stabilization time": set to "60 sec".
- [6] "TEMP READY monitoring start time": set to "30 sec".
- [7] "Time when TEMP READY goes off": Set to "10 sec".
- [8] "Switch TEMP READY alarm": Set to "WRN".
- [9] "TEMP READY alarm output": set to "ON".
- [10] "Temperature range upper limit alarm switching": set to "OFF".

- [11] "Add output of temperature range upper limit alarm": Set to "OFF".
- [12] "Temperature range lower limit alarm switching": Set to "OFF".
- [13] "Add output of temperature range lower limit alarm": Set to "OFF".

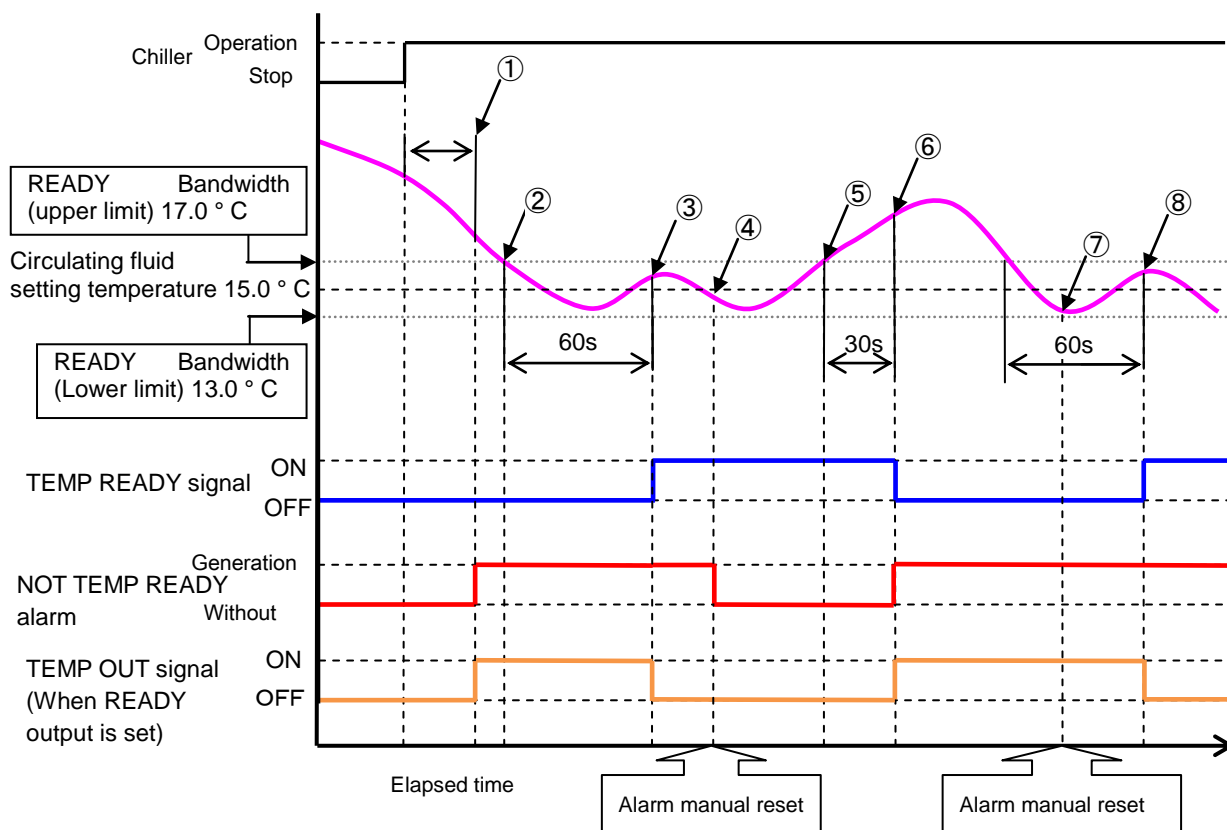

- State ①: Start of operation "30 sec" elapsed, alarm notice as the bandwidth is not reached in time. TEMP OUT signal ON.
- State ②: Although it is within the bandwidth range, since the "stable time of TEMP READY" has not elapsed, the alarm continues, TEMP OUT signal ON state continues.
- State ③: Stable time "60 sec" elapsed, TEMP OUT signal OFF. READY signal ON.
- State ④: Manual reset of alarm. Since the alarm cancellation condition is entered, the alarm OFF.
- State ⑤: Although it is out of band width, READY signal continues as "READY is out of time".
- State ⑥: Time when READY disappears after "30 sec" has elapsed, the READY signal OFF, alarm report, TEMP OUT signal ON.
- State ⑦: Manual reset of alarm. Since the alarm cancellation condition is not entered, the alarm ON continues.
- State ⑧: Stable time "60 sec" elapsed, TEMP OUT signal OFF. READY signal ON.

TEMP READY bandwidth lower limit

17. Press the [▼] key. Displays TEMP READY bandwidth lower limit setting screen.

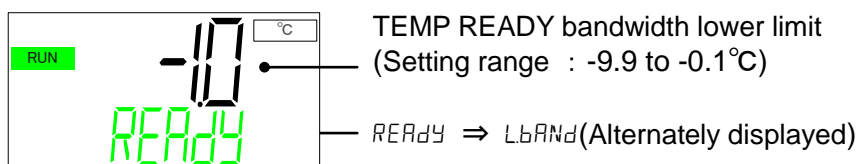

TEMP READY stability time

18. Press the [▼] key. Displays TEMP READY stability time setting screen.

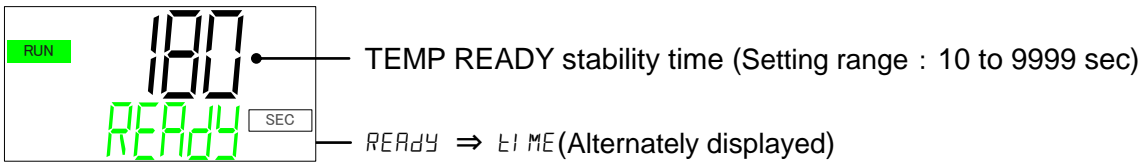

TEMP READY alarm of monitoring start time

19. Press the [▼] key. Displays TEMP READY alarm of monitoring start time setting screen.

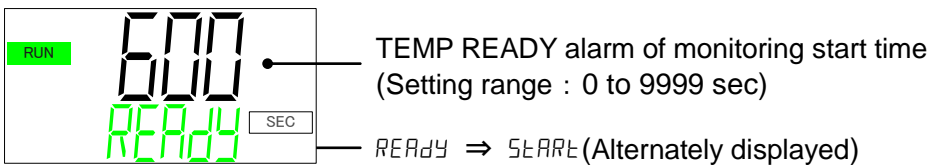

For the function, refer to P.5-26 [TEMP READY function setting example].

Time TEMP READY remove

20. Press the [▼] key. Displays Time TEMP READY remove setting screen.

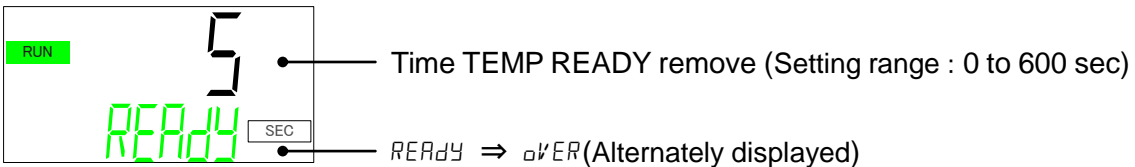

For the function, refer to P.5-26 [TEMP READY function setting example].

Maximum temperature range of temperature range monitoring function

21. Press the [▼] key. Displays Maximum temperature range of temperature range monitoring function setting screen.

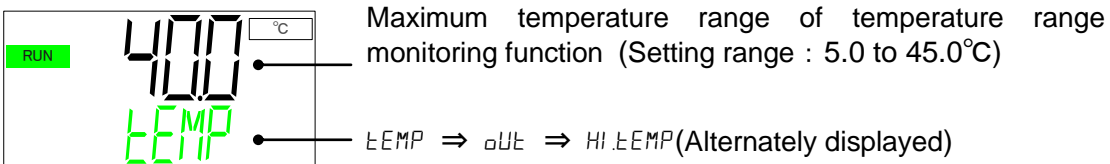

- Temperature range monitoring function
 When the circulating fluid temperature rises / falls, alarms "AL 14: circulating fluid temperature range rise" or "AL15: circulating fluid temperature drop" can occur. A TEMP OUT signal can be generated together with the alarm signal. Here is an example showing these relationships.

【Temperature range monitoring function setting example 1】

- [1] Circulating fluid temperature at start of operation: about 25°C
- [2] Circulating fluid set temperature : 15°C
- [3] Temperature range monitoring function (upper limit) : set to 「20.0°C」
- [4] 「Temperature range monitoring function (lower limit)」 : set to 「10.0°C」
- [5] 「Monitoring of temperature range monitoring function」 : Set to 「m.St」
- [6] 「Temperature range monitoring start time」 : Set to 「30sec」
- [7] 「Temperature range Time outside the monitoring range」 : Set to 「45sec」
- [8] 「Output of NOT TEMP READY alarm」 : Set to 「OFF」
- [9] 「Temperature range upper limit alarm switching」 : Set to 「WRN」
- [10] 「Add output of temperature range upper limit alarm」 : Set to 「ON」
- [11] 「Temperature range lower limit alarm switching」 : Set to 「WRN」
- [12] 「Add output of temperature range lower limit alarm」 : Set to 「ON」

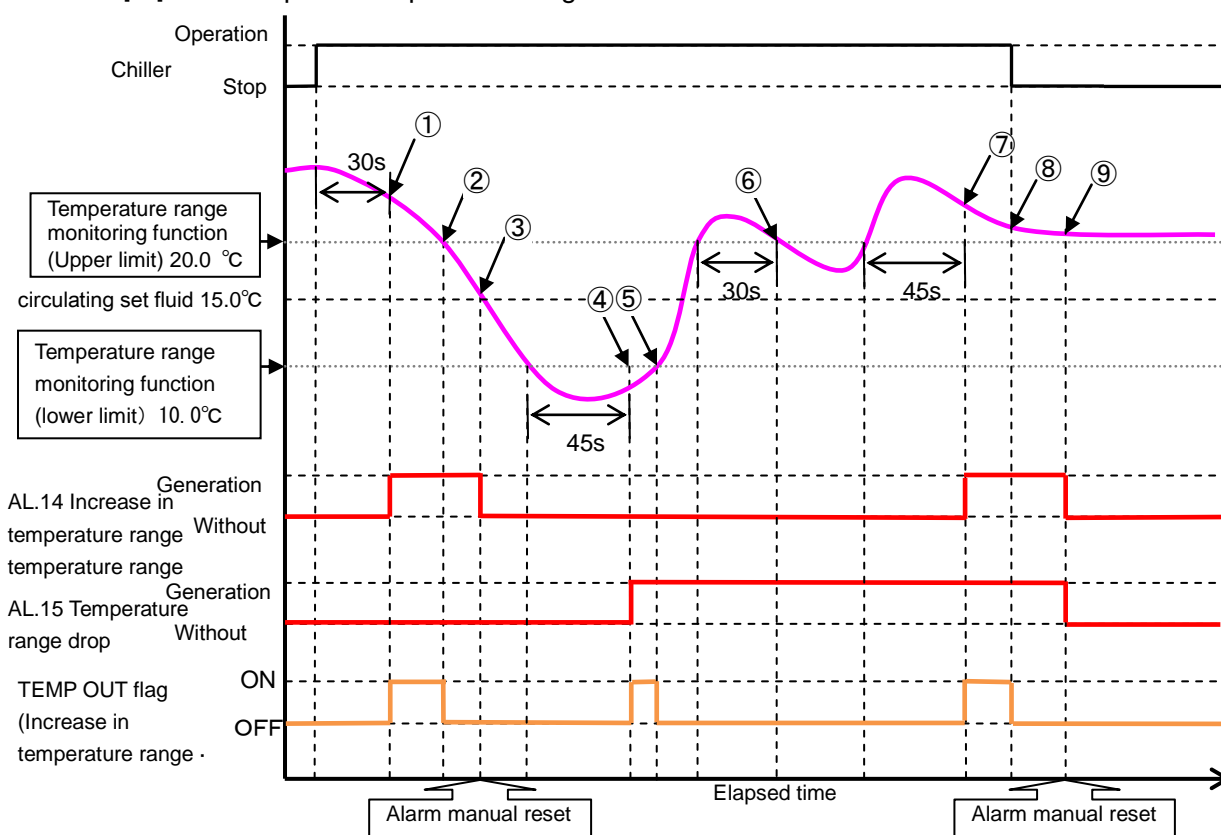

- State ①: Operation start 30 sec elapsed, because the temperature monitoring upper and lower limits have not been reached within the time range of monitoring the temperature range "AL.14" is triggered. "TEMP OUT" output ON.
- State ②: Enter temperature monitoring upper and lower limit range, "TEMP OUT" output OFF.
- State ③: Manual reset of alarm, "AL.14" cancellation.
- State ④: "AL.15" warning is issued because 45 sec has elapsed since the circulating fluid temperature deviated, because it is out of the temperature monitoring lower limit range. "TEMP OUT" output ON.
- State ⑤: Temperature monitoring enters the upper and lower limit range, "TEMP OUT" output OFF.
- State ⑥: Since the temperature range is again within the monitoring range, "AL.14" will not be reported and "TEMP OUT" Output OFF continues.
- State ⑦: AL.14 report since 45 sec has elapsed since the circulating fluid temperature deviated, because it is outside the upper temperature monitoring range. TEMP OUT output ON.
- State ⑧: Since operation stopped, "TEMP OUT" output OFF.

State ⑨: Manual reset of alarm, "AL.14", "AL.15" cancellation as monitoring condition is not included.

【Temperature range monitoring function setting example 2】

- [1] Circulating fluid temperature at start of operation: about 25°C
- [2] Circulating fluid set temperature : 15°C
- [3] Temperature range monitoring function (upper limit) : set to 「20.0°C」
- [4] 「Temperature range monitoring function (lower limit) 」 : set to 「10.0°C」
- [5] 「Monitoring of temperature range monitoring function」 : Set to 「PW.on」
- [6] "Temperature range monitoring start time": set to "30 sec". (It is invalid in continuous monitoring.)
- [7] "Time outside the temperature range monitoring range: set to" 45 sec "
- [8] "TEMP READY alarm output": set to "OFF".
- [9] "Temperature range upper limit alarm switching": Set to "WRN".
- [10] "Add output of temperature range upper limit alarm": Set to "ON".
- [11] "Temperature range lower limit alarm switching": set to "WRN".
- [12] "Add output of temperature range lower limit alarm": Set to "ON".

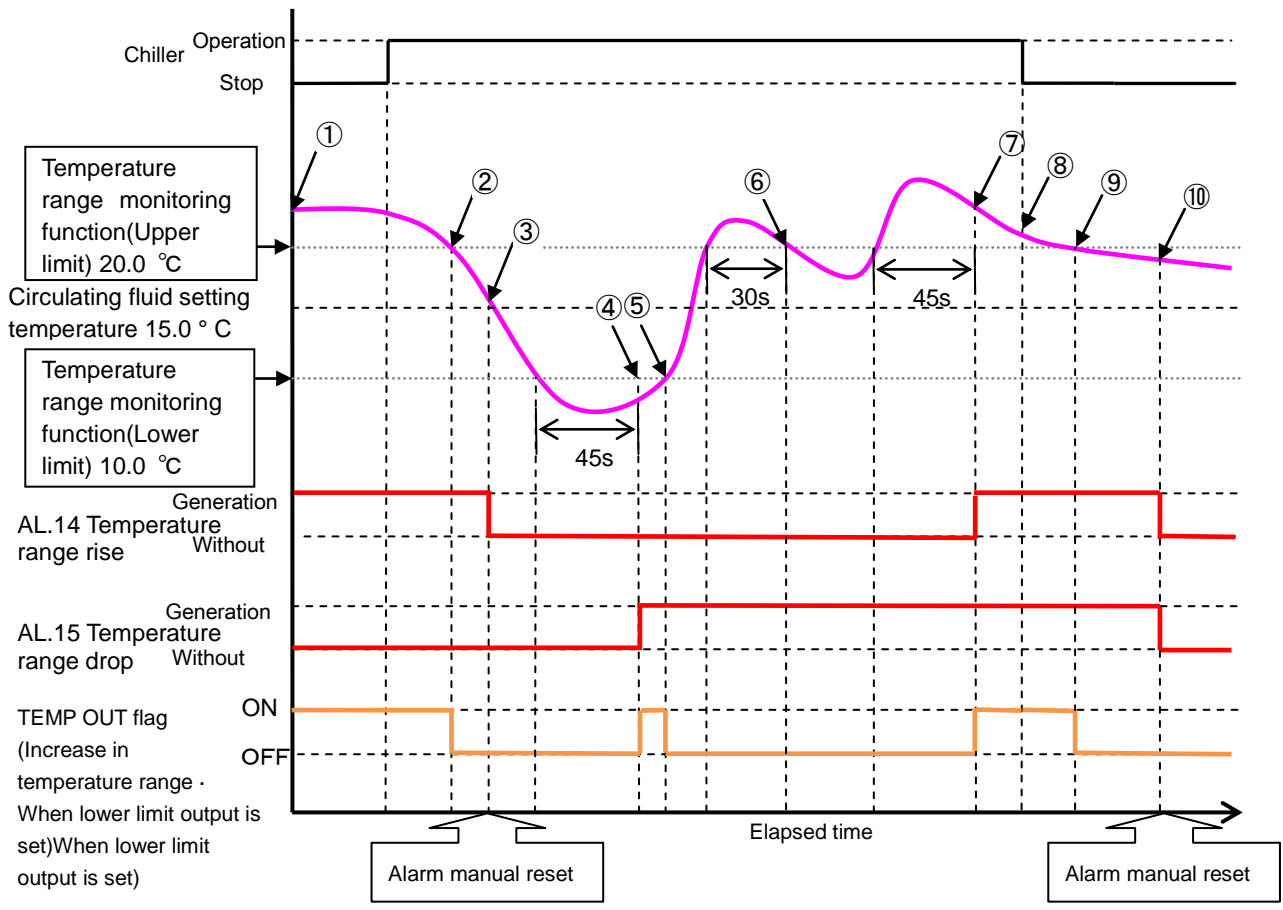

- State ①: An alarm "AL.14" is issued when the chiller is activated. "TEMP OUT" output ON.
- State ②: Enter temperature monitoring upper and lower limit range, "TEMP OUT" output OFF.
- State ③: Manual reset of alarm, "AL.14" cancellation.
- State ④: "AL.15" warning is issued because 45 sec has elapsed since the circulating fluid temperature deviated, because it is out of the temperature monitoring lower limit range. "TEMP OUT" output ON.

- State ⑤: Temperature monitoring enters the upper and lower limit range, "TEMP OUT" output OFF.
- State ⑥: Since the temperature range is again within the monitoring range, "AL.14" will not be reported and "TEMP OUT" Output OFF continues.
- State ⑦: AL.14 report since 45 sec has elapsed since the circulating fluid temperature deviated, because it is outside the upper temperature monitoring range. TEMP OUT output ON.
- State ⑧: The alarm is reset manually, the temperature monitoring upper and lower limit range is out, so "AL.14", "AL.15" warning continue.
- State ⑨: Since it is within the temperature monitoring upper limit range, "TEMP OUT" output OFF
- State ⑩: Manual reset of alarm "AL.14", "AL.15" cancellation.

Low temperature limit of temperature range monitoring function

22. Press the [▼] key. Displays Low temperature limit of temperature range monitoring function setting screen.

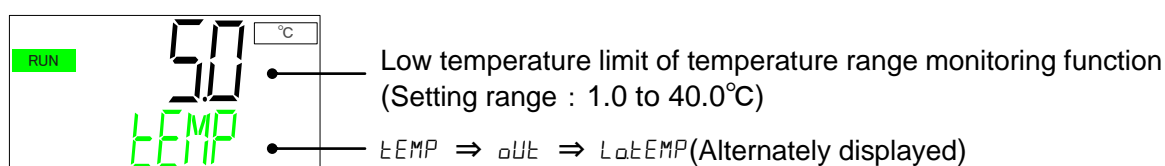

For the function, refer to P.5-29,P.5-30 [Temperature range monitoring function setting example].

Monitoring of temperature range monitoring function

23. Press the [▼] key. Displays monitoring of temperature range monitoring function setting screen

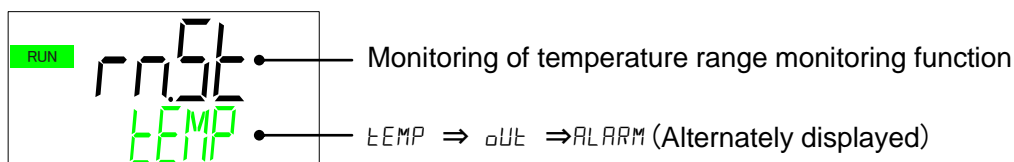

Please select from the following items.

Set value	Contents
rnSt	Monitoring during operation: The function is effective only during operation.
PWon	Always Monitoring: The function is enabled even when stopped (standby state).

For the function, refer to P.5-29,P.5-30 [Temperature range monitoring function setting example].

Temperature range monitor start time

24. Press the [▼] key. Displays temperature range monitor start time setting screen
 After operation starts, monitoring of the temperature range starts after a set time (sec).

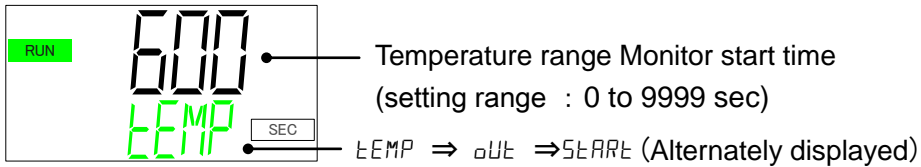

Refer to P.5-29,P.5-30 [Setting example of temperature range monitoring function].

Temperature range time outside monitoring range

25. Press the [▼] key. Displays time outside temperature range setting screen. When the circulating fluid temperature falls outside the temperature range, if it enters the range again within the set time (sec) a signal will not occur.

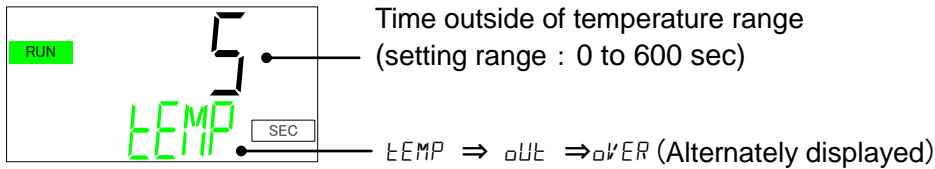

Refer to P.5-29,P.5-30 [Temperature range monitoring function setting example].

Dust filter replacement time

26. Press the [▼] key. Displays dust filter replacement time setting screen.

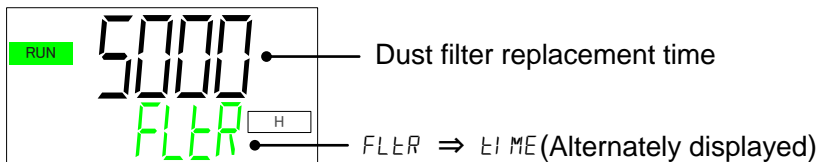

■ Dust filter replacement time

The maintenance time of the dust filter can be set by the user as a reminder to clean the filter. Maintenance notice "MT.04: Dustproof Filter Maintenance" will be generated after the set time has elapsed. For maintenance notification, refer to "5.4.4 Notice for maintenance Menu". The factory default setting is 5000 hours. The time can be set in the range of 1 to 9999 hours.

DI filter replacement time

27. Press the [▼] key. Displays DI filter replacement time setting screen.

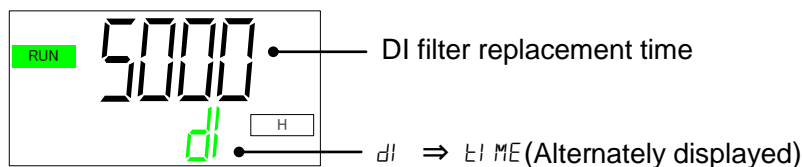

■ DI filter replacement time

The DI filter maintenance time can be set by the user as a reminder to replace the filter. Notice for maintenance "MT.05: DI filter maintenance" will be generated after the set time has elapsed.

For maintenance notification, refer to "5.4.4 Notice for maintenance Menu".

The factory default setting is 5000 hours.

The time can be set in the range of 1 to 9999 hours.

Temperature control speed

28. Press the [▼] key. Displays temperature control speed setting screen.

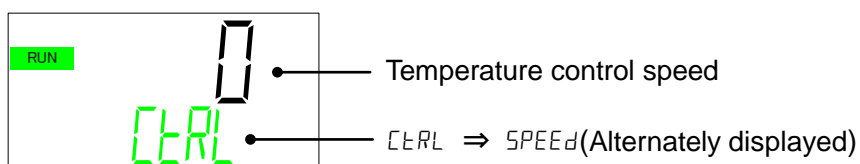

*Can be set from the serial "YR ***"

■ Temperature control speed

Change the temperature control speed.

The initial value is "0"

The higher the value, the temperature control will be fast.

The smaller the value, the temperature control will be slow.

5.5.4 Alarm setting menu

For some alarms, you can change the behavior and alarm threshold of when an alarm occurs.

Alarm setting menu TOP screen

1. When the [MENU] key is pressed while the Basic setting menu TOP screen is displayed, "Alarm setting Menu TOP screen" is displayed.

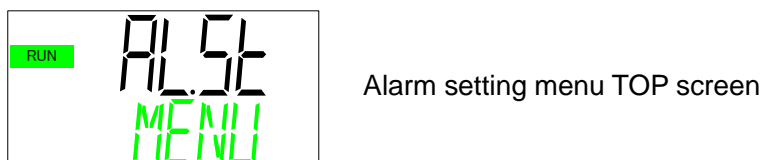

Changing of circulating fluid discharge pressure rise alarm behaviour

2. Press the [▼] key. Displays screen for changing the chiller behaviour when the circulating fluid discharge pressure rise alarm occurs.

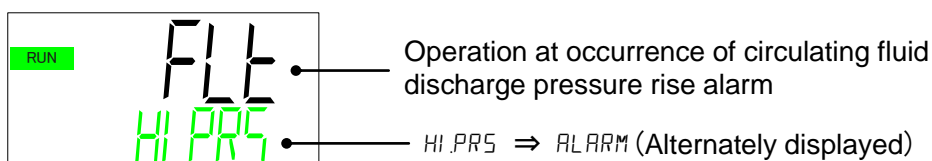

The user can decide the chiller behaviour if alarm "AL 09: circulating fluid discharge pressure rise" occurs.

Set value	Contents	Initial value
<i>brn</i>	Operation of this product will continue when the alarm occurs.	—
<i>FLt</i>	Operation of this product will stop when the alarm occurs.	○

Setting for circulating fluid discharge pressure rise threshold

3. Press the [▼] key. Displays screen for setting the circulating fluid discharge pressure rise threshold.

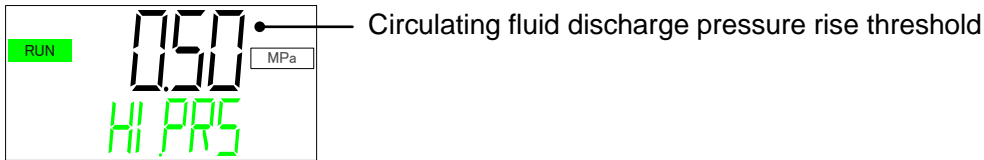

Alarm "AL 09: Circulating fluid discharge pressure rise" threshold can be changed.

- Setting range : 0.05 to 0.50MPa(Initial value : 0.50MPa)

Detection time for circulating fluid discharge pressure rise

4. Press the [▼] key. Displays screen for setting the detection time of the circulating fluid discharge pressure rise alarm .

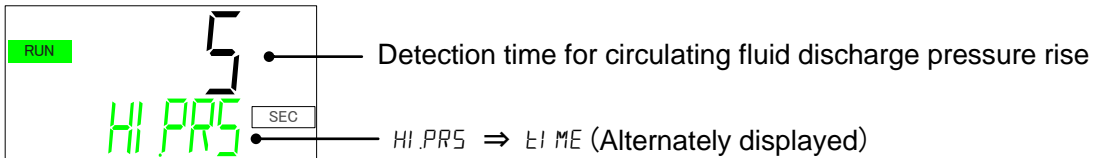

When the circulating fluid discharge pressure is above the threshold for this set amount of time : "AL09 circulating fluid discharge pressure rise" alarm is generated. The detection time can be set in the range shown below.

- Setting range : 0 to 60 sec(Initial value : 5 sec)

Changing of low flow rate alarm behaviour

5. Press the [▼] key. Displays screen for changing the chiller behaviour when the low flow rate alarm occurs.(In the case of option Z, Z1, this item will not be displayed.)

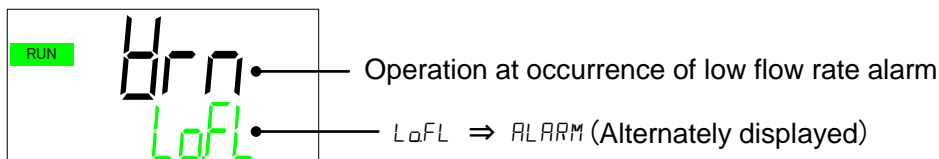

Alarm: The user can decide the chiller operation if alarm "AL10 low flow rate " occurs.

Set value	Contents	Initial value
oFF	Alarm is not generated.*	—
brn	Operation of this product will continue when the alarm occurs.	○
FLt	Operation of this product will stop when the alarm occurs.	—

*Can be set from the serial "YR ***"

Setting for low flow rate alarm threshold

- 6.** Press the [▼] key. Displays screen for setting low flow rate alarm threshold. (In the case of option Z, Z1, this item will not be displayed.)

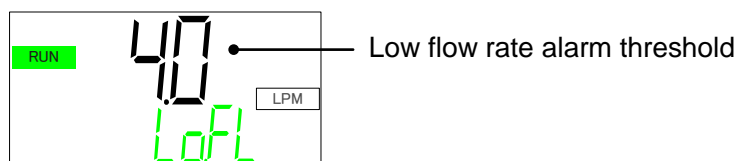

The user can change the threshold of "AL10 low flow rate " .

- Setting range : 2.0 to 15.0 LPM (Initial value : 4.0 LPM)

Detection time for low flow rate alarm

- 7.** Press the [▼] key. Displays screen for setting the detection time of the low flow rate alarm. (In the case of option Z, Z1, this item will not be displayed.)

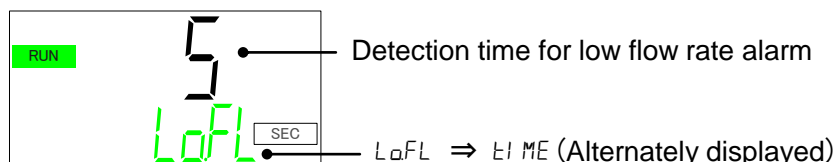

When the circulating fluid flow rate is below the threshold for this set amount of time alarm "AL10 low flow rate" is generated. The detection time can be set in the range shown below.

- Setting range : 0 to 600 sec (Initial value : 5 sec)

Changing of electric conductivity rise alarm

- 8.** Press the [▼] key. Displays screen for setting value of electric conductivity rise alarm threshold.

Displayed only when Option DM is selected [Electrical conductivity control function , DI water (pure water) piping].

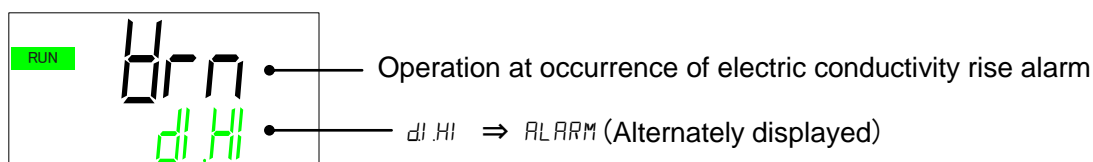

Alarm: The user can decide the chiller operation if alarm "AL12 electric conductivity rise " occurs.

Set value	Contents	Initial value
<i>oFF</i>	Alarm is not generated.	—
<i>On</i>	Operation of this product will continue when the alarm occurs.	○

Setting for electric conductivity rise alarm

9. Press the [▼] key. Displays screen for setting value of electric conductivity rise alarm threshold.

Displayed only when Option DM is selected [Electrical conductivity control function , DI water (pure water) piping].

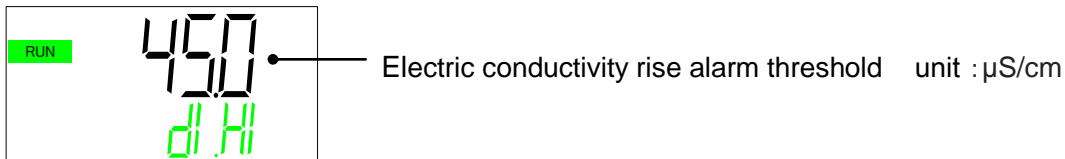

The user can change the threshold of "AL12 electric conductivity rise."

●Setting range : 0.4 to 46.0 μS/cm(Initial value : 45.0 μS/cm)

Setting of NOT TEMP READY alarm

10. Press the [▼] key. Displays screen for changing the chiller behaviour when the NOT TEMP READY alarm occurs.

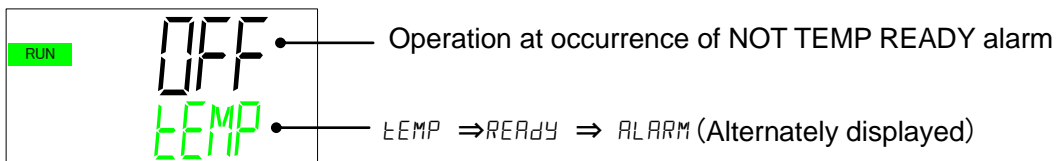

The user can decide the chiller behaviour if alarm "AL13: NOT TEMP READY" occurs.

Set value	Contents	Initial value
<i>oFF</i>	Alarm is not generated.	○
<i>On</i>	Operation of this product will continue when the alarm occurs.	—
<i>FLt</i>	Operation of this product will stop when the alarm occurs.	—

Output of NOT TEMP READY

11. Press the [▼] key. Displays screen for setting the output of the NOT TEMP READY signal.

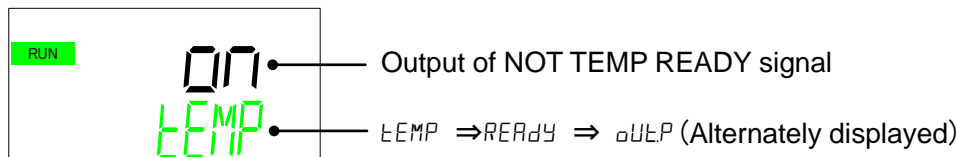

The user can select whether there is an output signal when alarm "AL13 NOT TEMP READY" occurs.

Set value	Contents	Initial value
on	Output signal to contact output or serial communication.	○
off	No signal is output.	—

[Example]

If the user does not want to generate an alarm, but wants a signal for contact output or serial communication when alarm "AL13: NOT TEMP READY" occurs, it can be set as follows.

- Change NOT TEMP READY alarm : off
 - Output of NOT TEMP READY signal : on
- } No alarm is generated, but a signal is output.

Changing of circulating fluid temperature rise

12. Press the [▼] key. Displays screen for changing the chiller behaviour when the circulating fluid temperature rise alarm occurs.

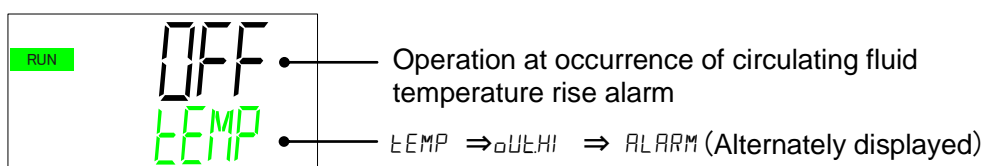

The user can decide the chiller behavior if alarm "AL14 circulating fluid temperature rise" occurs.

Set value	Contents	Initial value
off	Alarm is not generated.	○
brn	Operation of this product will continue when the alarm occurs.	—
FLt	Operation of this product will stop when the alarm occurs.	—

Output of circulating fluid temperature rise signal

13. Press the [▼] key. Displays screen for setting the output of circulating fluid temperature rise signal.

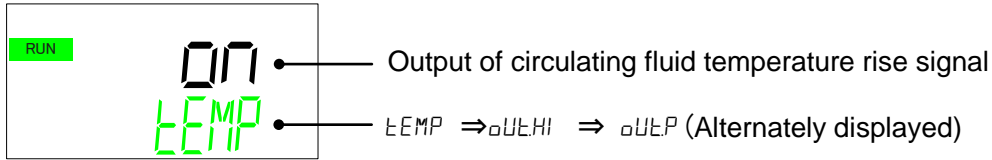

The user can select whether there is an output signal when alarm "AL14 circulating fluid temperature rise" occurs.

Set value	Contents	Initial value
on	Output signal to contact output or serial communication.	○
off	No signal is output.	—

Changing of circulating fluid temperature drop alarm behaviour

14. Press the [▼] key. Displays screen for changing the chiller behaviour when the circulating fluid temperature drop alarm occurs.

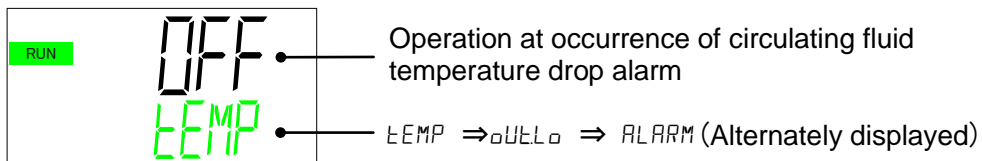

The user can decide select the chiller behavior if alarm "AL15 circulating fluid temperature drop" occurs.

Set value	Contents	Initial value
off	Alarm is not generated.	○
Run	Operation of this product will continue when the alarm occurs.	—
FLt	Operation of this product will stop when the alarm occurs.	—

Output of the circulating fluid temperature drop alarm.

15. Press the [▼] key. Displays screen for output setting of the circulating fluid temperature drop alarm.

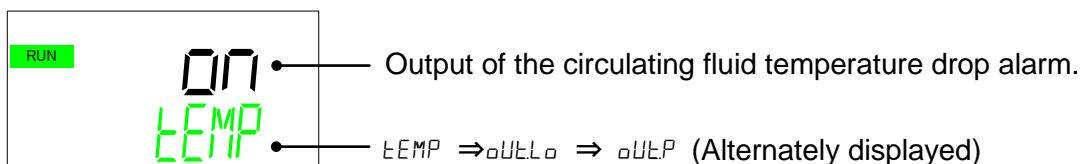

Output of alarm AL15: Circulating fluid temperature drop

Set value	Contents	Initial value
on	Contact output, or serial communication signal is output.	○
off	Signal is not output.	—

Switching of the ambient temperature alarm

16. Press the [▼] key. Displays screen for changing the chiller behaviour when the ambient temperature alarm occurs. Displayed for air-cooled type only. (This item is not displayed for water-cooled type)

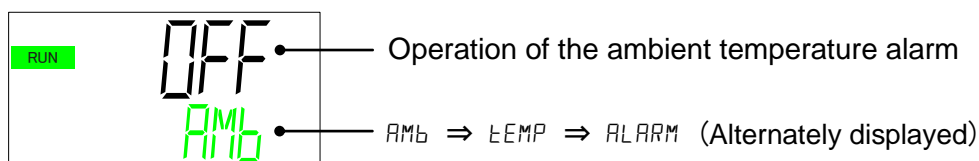

Operation for alarm AL11: Ambient temperature alarm can be selected.

Set value	Contents	Initial value
off	Alarm is not generated	○
run	Operation of this product will continue when the alarm occurs.	—
flt	Operation of this product will stop when the alarm occurs.	—

Ambient temperature upper limit alarm

17. Press the [▼] key. Displays screen for setting the upper limit of the ambient temperature. Displayed for air-cooled type only. (This item is not displayed for water-cooled type)

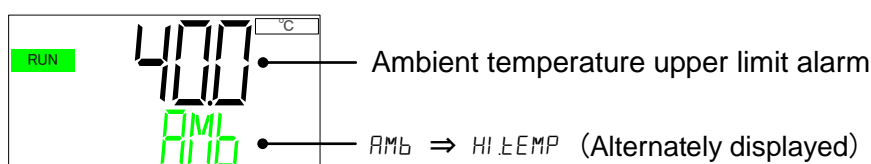

Upper limit of alarm AL11: Ambient temperature alarm can be changed.

- Setting range: 5.0 to 45.0°C (initial value: 40.0°C)

Ambient temperature lower limit alarm

18. Press the [▼] key. Displays screen for setting the lower limit of the ambient temperature alarm.

Displayed for air-cooled type only. (This item is not displayed for water-cooled type)

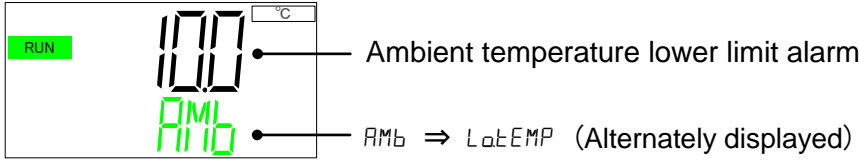

Lower limit of alarm AL11: Ambient temperature alarm can be changed.

- Setting range: 5.0 to 40.0°C (initial value: 10.0°C)

Switching of the leakage alarm

19. Press the [▼] key. Displays screen for setting the leakage alarm operation. (In the case of option Z, this item will not be displayed.)

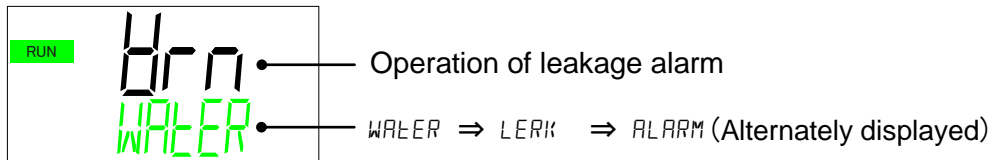

Operation for alarm AL04: Leakage alarm can be selected.

Set value	Contents	Initial value
oFF	Alarm is not generated.	—
brn	Operation of this product will continue when the alarm occurs.	○
FLt	Operation of this product will stop when the alarm Occurs.	—

Switching of the contact input signal 1

20. Press the [▼] key. Displays screen for setting the operation of the Contact input signal 1.

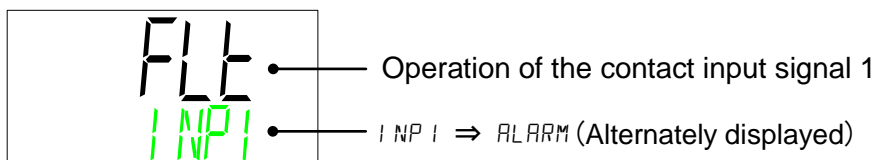

Operation for alarm AL25: Contact input signal 1 detection can be selected.

Set value	Contents	Initial value
oFF	Alarm is not generated.	—
brn	Operation of this product will continue when the alarm occurs.	—
FLt	Operation of this product will stop when the alarm occurs.	○

Contact input signal 1 delay timer for reading

21. Press the [▼] key. Displays screen for setting the Contact input signal 1 Delay timer for reading.

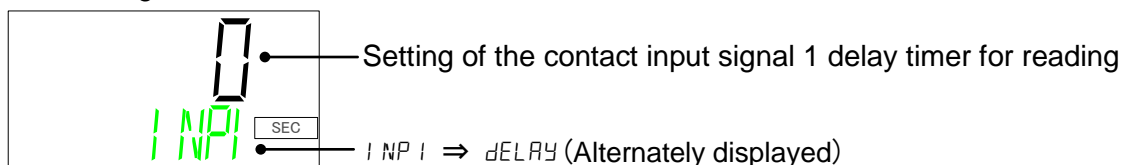

Time for starting detection of the contact input signal 1 (sec) can be set.

- Setting range: 0 to 300sec. (Initial value: 0sec.)

Contact input signal 1 OFF detection timer

22. Press the [▼] key. Displays screen for setting the OFF detection timer of Contact input signal 1.

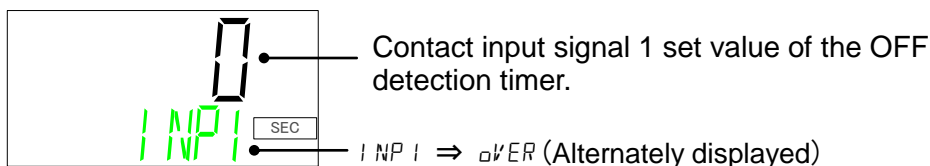

“Alarm AL25: Contact input signal 1 detection” is generated when the set time(sec) passed from when the contact input signal 1 is not detected.

(When the signal is not detected for the set time, the alarm is generated)

- Setting range: 0 to 10sec. (Initial value: 0sec.)

Switching of the contact input signal 2

23. Press the [▼] key. Displays screen for setting the operation for the Contact input signal 2.

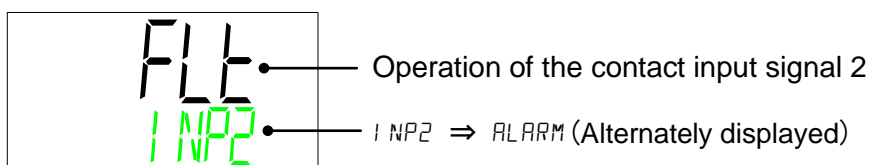

Operation for alarm AL26: Contact input signal 2 detection can be selected.

Set value	Contents	Initial value
oFF	Alarm is not generated.	—
brn	Operation of this product will continue when the alarm occurs.	—
FLt	Operation of this product will stop when the alarm occurs.	○

Contact input signal 2 delay timer

24. Press the [▼] key. Displays screen for setting the Contact input signal 2 detection delay timer for reading.

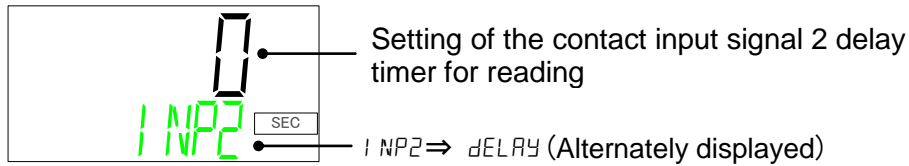

Time for starting detection of the contact input signal 2 (sec) can be set.
 •Setting range: 0 to 300sec. (Initial value: 0sec.)

Contact input signal 2 OFF detection time

25. Press the [▼] key. Displays screen for setting the contact input signal 2 OFF detection timer.

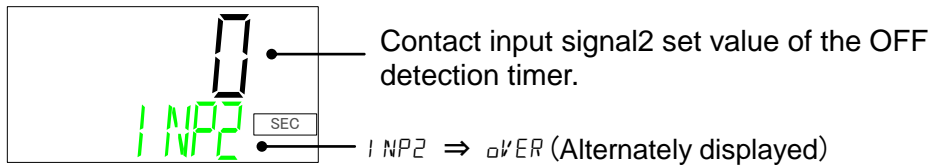

“Alarm AL26: Contact input signal 2 detection” is generated when the set time(sec) passed from when the contact input signal 2 is not detected.
 (When the signal is not detected for the set time, alarm is generated)
 •Setting range: 0 to 10sec. (Initial value: 0sec.)

Switching of communication error alarm

26. Press the [▼] key. Displays screen for setting the communication error alarm operation.

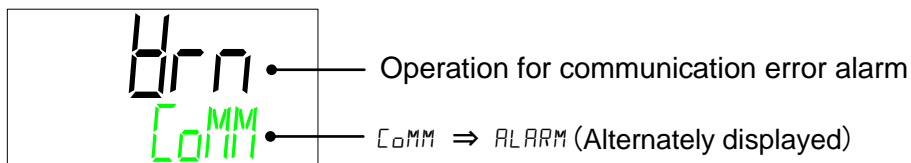

Operation for alarm AL29: Communication error can be selected.

Set value	Contents	Initial value
oFF	Alarm is not generated.	—
Hrn	Operation of this product will continue when the alarm occurs.	○
FLt	Operation of this product will stop when the alarm occurs.	—

Communication error alarm detection time

27. Press the [▼] key. Displays screen for setting the communication error alarm detection time.

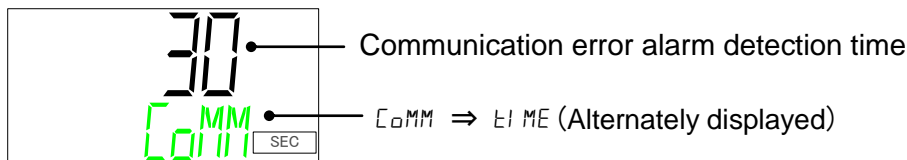

Time (sec.) to generate alarm AL29: Communication error can be changed.

- Setting range: 0 to 600sec. (Initial value: 30sec.)

Time for pump to continue operation when alarm is generated.

28. Press the [▼] key. Displays screen for setting the time for the pump to continue operation when an alarm is generated.

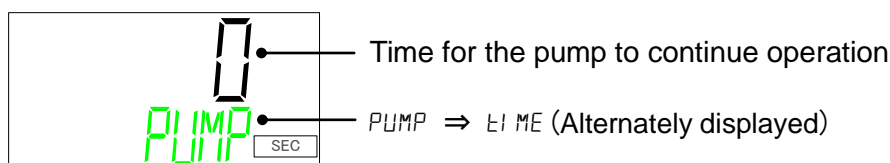

- Setting range: 0 to 9999sec. (Initial value: 0sec.)

■ About the continuation of the pump operation

By setting this time, some alarms allow to continue pump operation even when the alarm is generated. The table below shows the alarms which allow to continue pump operation.

·
·

Pump continuous operation during alarm generation finishes by satisfaction of one of the following condition.

- (1) When the pump continuous operation time reaches the set time above.
- (2) When the circulating fluid temperature reaches the upper limit of temperature for pump continuous operation (refer to P.5-43 "28.").

Table 5.5-1 List of alarms which allow to continue pump operation

Alarm no.	Alarm name	Initial value	Display		Alarms which allow to continue pump operation
			Upper line (White)	Lower line (Green)	
AL01	Low level in tank	FLT	AL01	LOW⇒LEVEL⇒FLT	-
AL02	Low level in tank	WRN	AL02	LOW⇒LEVEL⇒WRN	-
AL04	Water leakage ^{*1}	WRN ^{*2}	AL04	WATER ⇒ LEAK	○
AL05	Pump inverter error ^{*3}	WRN	AL05	PUMP ⇒ INV	-
AL06	Internal fan stop ^{*4}	WRN	AL06	FAN ⇒ ERROR	-
AL09	Circulating fluid discharge pressure rise	FLT ^{*5}	AL09	HIGH ⇒ PRESS	-
AL10	Flow rate decreased ^{*6}	WRN ^{*2}	AL10	LOW⇒FLOW⇒WRN	○
AL11	Ambient temperature is out of the range ^{*7}	OFF ^{*2}	AL11	AMB⇒TEMP⇒OUT	○
AL12	Electric conductivity increase ^{*8}	WRN ^{*9}	AL12	DI ⇒ ERROR	-
AL13	NOT TEMP READY	OFF ^{*2}	AL13	TEMP⇒READY⇒ERROR	○
AL14	Circulating fluid temperature increase	OFF ^{*2}	AL14	TEMP⇒OUT.HI	○
AL15	Circulating fluid temperature decrease	OFF ^{*2}	AL15	TEMP⇒OUT.LO	○
AL17	Low flow rate ^{*10}	FLT ^{*2}	AL17	LOW⇒FLOW⇒FLT	-
AL18	High circulating fluid discharge temp.	FLT	AL18	TEMP ⇒ FLT	-
AL19	High circulating fluid return temp.	FLT	AL19	RET⇒TEMP⇒FLT	○
AL21	High circulating fluid discharge pressure	FLT	AL21	HIGH⇒PRESS⇒FLT	-
AL22	Low circulating fluid discharge pressure	FLT	AL22	LOW⇒PRESS⇒FLT	-
AL24	Memory error	FLT	AL24	MEM ⇒ ERROR	○
AL25	Contact input 1 signal detection	FLT ^{*2}	AL25	INP1 ⇒ ERROR	○
AL26	Contact input 2 signal detection	FLT ^{*2}	AL26	INP2 ⇒ ERROR	○
AL27	Forced stop	FLT	AL27	FORCE ⇒ STOP	-
AL28	Notice for maintenance	OFF ^{*2}	AL28	MANT ⇒ ALARM	○
AL29	Communication error	WRN ^{*2}	AL29	COMM ⇒ ERROR	○
AL30	Compressor circuit error	FLT	AL30	REF⇒ERROR⇒0000	○
AL31	Sensor error	FLT	AL31	SENS⇒ERROR⇒0000	-
AL32	Controller error	FLT	AL32	CTRL⇒ERROR⇒0000	-

*1 Not generated for options Z.

*2 Select from OFF/WRN / FLT.

*3 Only option T1.

*4 Only water-cooled refrigerated type with option T1.

*5 Select from WRN / FLT.

*6 Not generated for options Z and Z1.

*7 Only air-cooled refrigerated type.

*8 Only option -DM. Alarm is automatically released when the electric conductivity returns within the range.

*9 Select from OFF/WRN.

*10 Not generated for options Z and Z1. However, for models that include options T1 and Z or T1 and Z1, it generate at 7L / min or less.

Temperature for pump to continue operation when alarm is generated.

29. Press the [▼] key. Displays screen for setting the upper limit of temperature for the pump to continue operation when an alarm is generated.

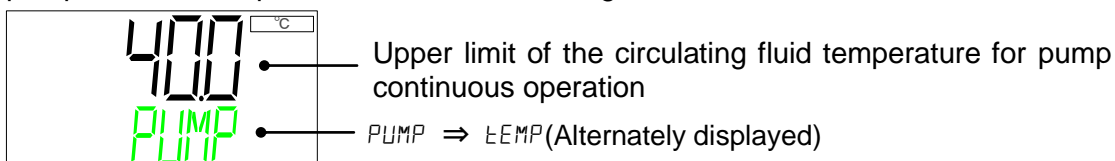

- Setting range: 5.0 to 45.0°C (initial value: 40.0°C)

Refer to P.5-43 "Time for pump to continue operation" for settings.

Switching of the notice for maintenance

30. Press the [▼] key. Displays screen for setting the switching of the notice for maintenance. Alarm AL28: Notice for maintenance is generated.

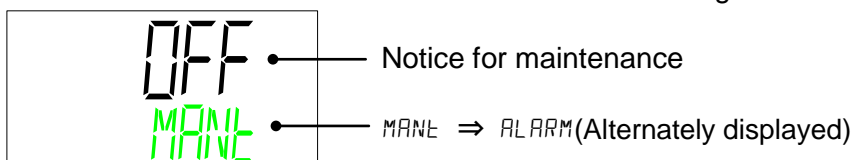

Operation for alarm AL28: Notice for maintenance can be selected.

Set value	Contents	Initial value
OFF	Alarm is not generated. Only "X" is displayed when a notice for maintenance is generated.	○
Brn	Operation of this product will continue when the alarm occurs.	—
FLt	Operation of this product will stop when the alarm occurs.	—

Switching of the Flow rate failure alarm

31. Press the [▼] key. Displays screen for setting the switching of the Flow rate failure Alarm. (In the case of option Z, Z1, this item will not be displayed.)

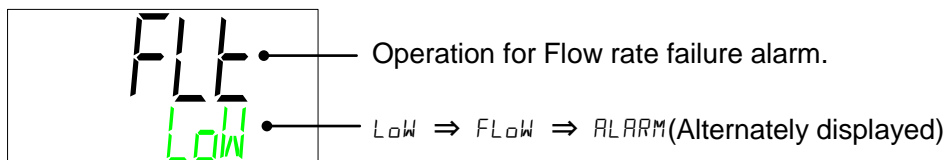

Operation for alarm AL17: Flow rate failure can be selected.

Set value	Contents	Initial value
OFF	Alarm is not generated.*	—
Brn	Operation of this product will continue when the alarm occurs.	—
FLt	Operation of this product will stop when the alarm occurs.	○

* Can be set from the serial "YR ***"

5.5.5 Communication setting menu

Contact input and serial communication can be performed.
 Refer to the Operation Manual Communication Function for more details.

Communication setting menu TOP screen

1. When “MENU” key is pressed while Alarm Setting Menu TOP screen is displayed, the display is changed to the top of “Communication setting menu”.



Communication setting menu TOP screen

Serial protocol

2. Press the [▼] key. Displays screen for setting the serial protocol.



Serial protocol.

Select communication protocol.

Set value	Contents	Initial value
ASC	ASCII mode	○
RTU	RTU mode	—

Communication specification

3. Press the [▼] key. Displays screen for setting the communication specifications.



Communication specification

Select the communication specification.

Set value	Contents	Initial value
485	RS-485	○
232C	RS-232C	—

RS-485 terminal unit

4. Press the [▼] key. Displays screen for setting RS-485 terminal unit.

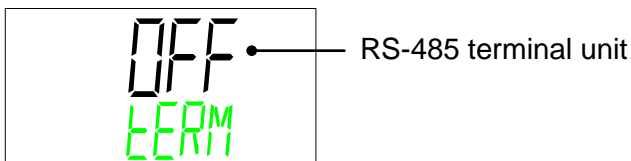

Select RS-485 terminal unit.

Set value	Contents	Initial value
oFF	No terminal	○
oN	With terminal	—

Slave addresses

5. Press the [▼] key. Displays screen for setting the slave address.

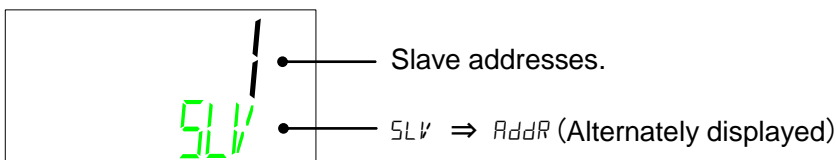

Sets slave address.

- Setting range: 1 to 32 (Initial value: 1)

Communication speed

6. Press the [▼] key. Displays screen for setting the communication speed.

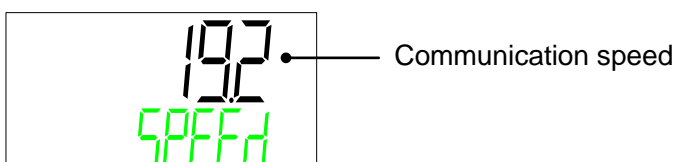

Selects the communication speed.

Set value	Contents	Initial value
9 .6	9600 bps	—
19 .2	19200 bps	○

Contact input signal 1 Select function

7. Press the [▼] key. Displays screen for setting the function of the Contact input signal 1.

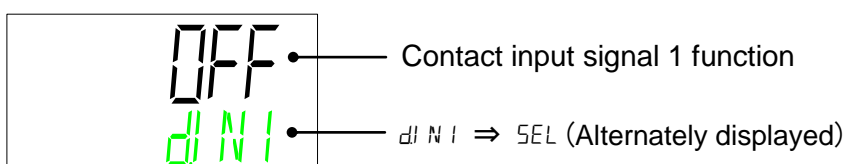

Displays the function for the Contact input signal 1.

Set value	Contents	Initial value
OFF	No input signal	○
RNSL	Run / stop signal is input	—
RUN	Run signal is input	—
SW	External switch signal input	—

Contact input signal 1 type

8. Press the [▼] key. Displays screen for setting the type of Contact input signal 1.

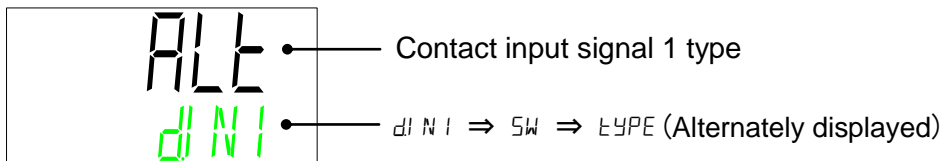

Displays the type of Contact input signal 1.

Set value	Contents	Initial value
ALL	Alternate signal	○
āL	Momentary signal	—

Contact input signal 1 Operation

9. Press the [▼] key. Displays screen for setting the operation of the Contact input signal 1.

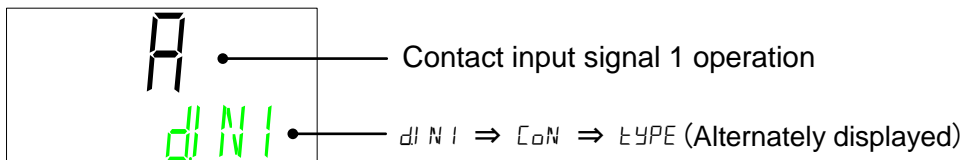

Select the Contact input signal 1 operation.

Set value	Contents	Initial value
A	N.O. type	○
B	N.C. type	—

Contact input signal 2 Select function

10. Press the [▼] key. Displays screen for setting the function of the Contact input signal 2.

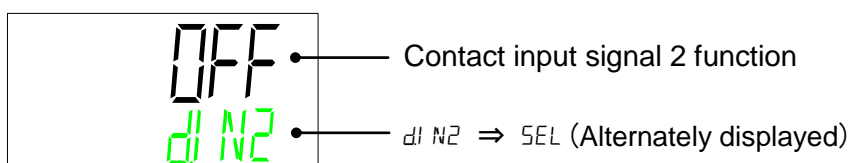

Displays the function of the Contact input signal 2.

Set value	Contents	Initial value
oFF	No input signal	○
StoP	Stop signal input	—
Sw	External switch signal input	—

Contact input signal 2 type

11. Press the [▼] key. Displays screen for setting the type of Contact input signal 2.

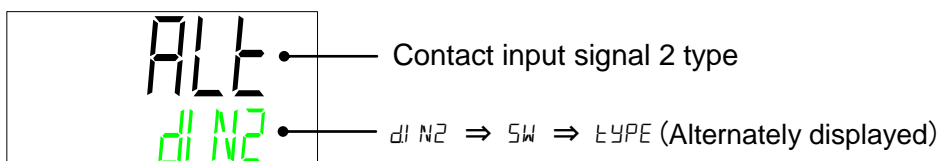

Displays the type of Contact input signal 2.

Set value	Contents	Initial value
ALL	Alternate signal	○
nL	Momentary signal	—

Contact input signal 2 Operation

12. Press the [▼] key. Displays screen for setting the operation of the Contact input signal 2.

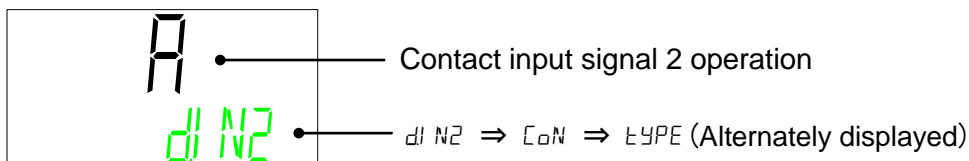

Select the Contact input signal 2 operation.

Set value	Contents	Initial value
A	N.O. type	○
B	N.C. type	—

Contact input signal 2 Operation

13. Press the [▼] key. Displays screen for setting the function of the Contact output signal 1.

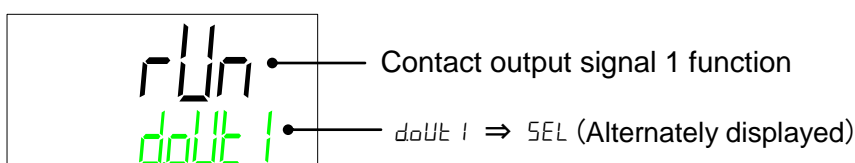

Displays the function of the Contact output signal 1.

Set value	Explanation	Initial value (Default setting)
oFF	No output signal	—
rUn	Operation status signal output	○
rnt	Remote status signal output	—
ELt	Unused	—
r d y	Ready completion (TEMP READY) signal output	—
t o u t	TEMP OUT (temperature is out of the range) signal output	—
F L t	FLT (operation stop) alarm signal output	—
W R n	WRN (operation continue alarm) signal output	—
n A n t	Notice for maintenance signal output	—
A L n	Alarm status signal output	—
S H 1	Pass through signal of the contact input signal 1	—
S H 2	Pass through signal of the contact input signal 2	—
a S E L	Selected alarm status signal output	—
n S E L	Selected notice for maintenance signal output	—

Contact output signal 1 Operation

14. Press the [▼] key. Displays screen for setting the operation for the Contact output signal 1.

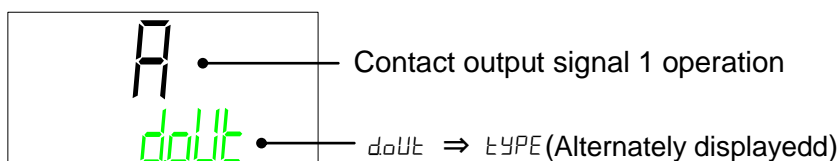

Select the Contact output signal 1 operation.

Set value	Contents	Initial value
A	N.O. type	○
B	N.C. type	—

Contact output signal 1 Select alarm

15. Press the [▼] key. Displays screen for setting the selected alarm for the Contact output signal 1. The alarm is valid when the “selected alarm status signal output” is active.

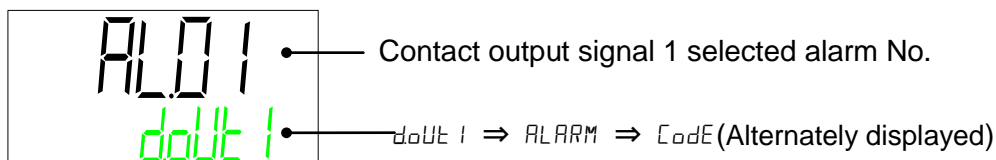

Select the alarm No. to be allocated to Contact output signal 1

- Setting range: AL.01 to AL.32 (Default value: AL.01)

Contact output signal 1 Select maintenance

16. Press the [▼] key. Displays screen for setting the selected maintenance for the Contact output signal 1. The alarm is valid when the “selected maintenance status signal output” is active.

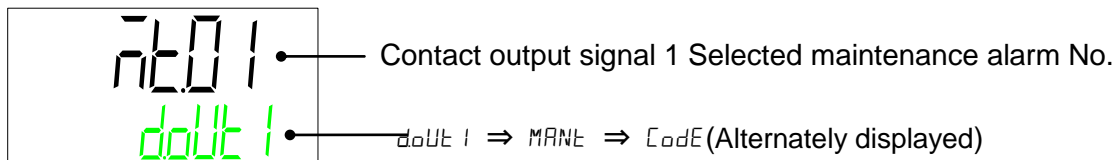

Select the maintenance alarm No. to be allocated to Contact output signal 1.

- Setting range: MT.01 to MT.05 (Initial value: MT.01)

Contact output signal 2 Select function

17. Press the [▼] key. Displays screen for setting the function for the Contact output signal 2.

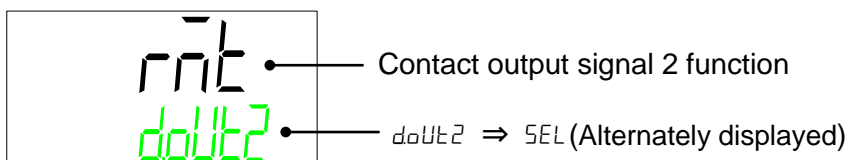

Displays the function for the Contact output signal 2.

Set value	Explanation	Initial value (Default setting)
oFF	No output signal	—
rUn	Operation status signal output	—
rnE	Remote status signal output	○
ELtE	Unused	—
r d Y	Ready completion (TEMP READY) signal output	—
t.oUt	TEMP OUT (temperature is out of the range) signal output	—
FLt	FLT (operation stop) alarm signal output	—
WRt	WRN (operation continue alarm) signal output	—
nAnt	Notice for maintenance signal output	—
ALn	Alarm status signal output	—
S.H.1	Pass through signal of the contact input signal 1	—
S.H.2	Pass through signal of the contact input signal 2	—
ALSEL	Selected alarm status signal output	—
n.SEL	Selected notice for maintenance signal output	—

Contact output signal 2 Operation

18. Press the [▼] key. Displays screen for setting the operation of the Contact output signal 2.

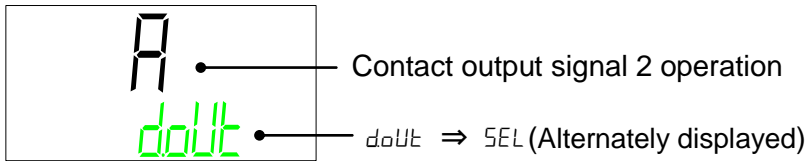

Select the Contact output signal 2 operation.

Set value	Contents	Initial value
A	N.O. type	○
B	N.C. type	—

Contact output signal 2 Select alarm

19. Press the [▼] key. Displays screen for setting the selected alarm of the Contact output signal 2. The alarm is valid when the “selected alarm status signal output” is active.

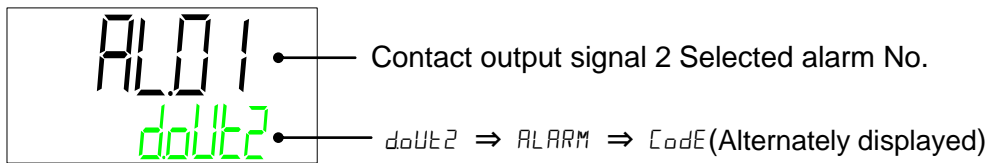

Select the alarm No. to be allocated to Contact output signal 2

- Setting range: AL.01 to AL.32 (Initial value: AL.01)

Contact output signal 2 Select maintenance

20. Press the [▼] key. Displays screen for setting the selected maintenance of the Contact output signal 2. The alarm is valid when the “selected maintenance status signal output” is selected.

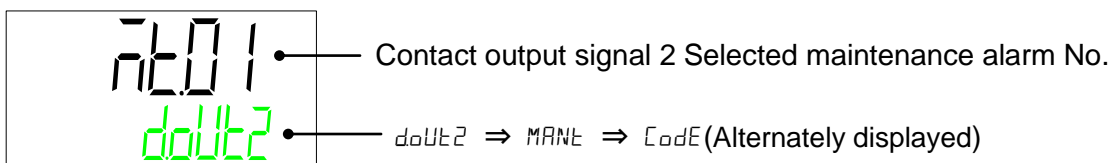

Select the maintenance alarm No. to be allocated to Contact output signal 2.

- Setting range: MT.01 to MT.05 (Initial value: MT.01)

Contact output signal 3 Select function

21. Press the [▼] key. Displays screen for setting the function of the Contact output signal 3.

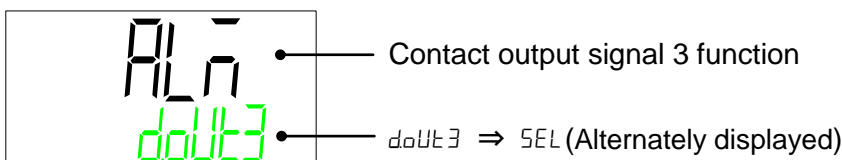

Displays the function of the Contact output signal 3.

Set value	Explanation	Initial value (Default setting)
oFF	No output signal	—
rUn	Operation status signal output	—
rnt	Remote status signal output	—
Ent	Unused	—
rdy	Ready completion (TEMP READY) signal output	—
toUt	TEMP OUT (temperature is out of the range) signal output	—
FLt	FLT (operation stop) alarm signal output	—
WRt	WRN (operation continue alarm) signal output	—
nAnt	Notice for maintenance signal output	—
ALn	Alarm status signal output	○
SH1	Pass through signal of the contact input signal 1	—
SH2	Pass through signal of the contact input signal 2	—
ASEL	Selected alarm status signal output	—
nSEL	Selected notice for maintenance signal output	—

Contact output signal 3 Operation

22. Press the [▼] key. Displays screen for setting the operation of the Contact output signal 3.

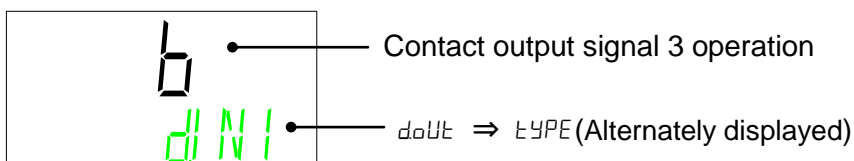

Contact output signal 3 operation

Set value	Contents	Initial value
A	N.O. type	—
B	N.C. type	○

Contact output signal 3 Select alarm

23. Press the [▼] key. Displays screen for setting the selected alarm of Contact output signal 3. The alarm is valid when the “selected alarm status signal output” is active.

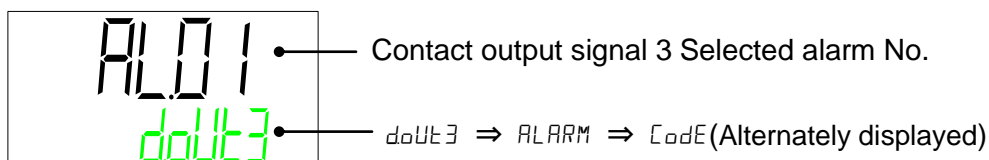

Select the alarm No. to be allocated to Contact output signal 3

- Setting range: AL.01 to AL32 (Initial value: AL01)

Contact output signal 3 Select maintenance

- 24.** Press the [▼] key. Displays screen for setting the selected maintenance of Contact output signal 3. The alarm is valid when the “selected maintenance status signal output” is active.

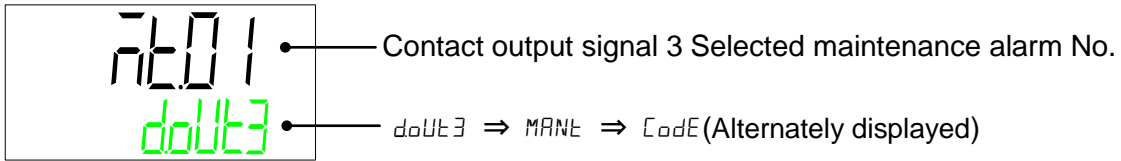

Select the maintenance alarm No. to be allocated to Contact output signal 3.

- Setting range: MT.01 to MT.05 (Initial value: MT.01)

5.5.6 Reset menu

Values set by the customer are changed back to the default values.

Operation time / Length of operation are reset.

Reset menu TOP screen

- 1.** When the “MENU” key is pressed while the Communication Setting Menu TOP screen is displayed, the display is changed to the “Reset menu TOP screen”.

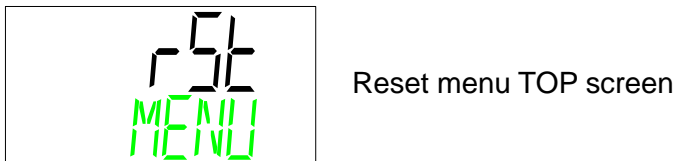

Set data reset

- 2.** Press the [▼] key. Displays screen for data reset.

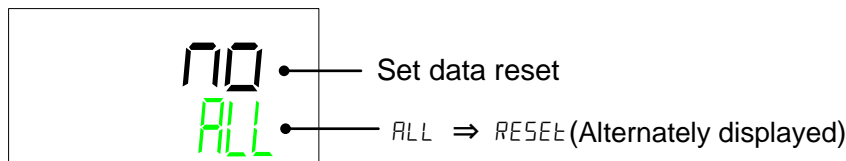

Press “ENT” key when resetting the data. When the display is flashing, press [▲], [▼] key and select “YES”, then, press “ENT” key.

Set value	Contents	Initial value
no	Not reset	○
YES	Resets all the data (Operation time/ Length of operation are not reset)	—

⚠ CAUTION



This function resets all the set values. Use caution when operating this function. It is recommended to record the set data before resetting.

Reset of operation time of the pump

3. Press the [▼] key. Displays screen for resetting the operation time of the pump.

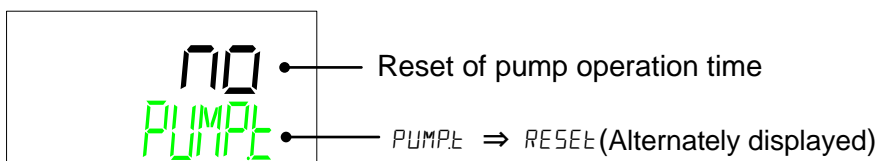

When the operation time of the pump is reset, the operation time becomes “0 hour”.
When MT.01: Notice for pump maintenance is generated, reset the notice for pump maintenance.

Press “ENT” key when resetting the operation time of the pump. When the display is flashing, press [▲], [▼] key and select “YES”. Then, press “ENT” key.

Set value	Contents	Initial value
no	No reset.	○
YES	Reset pump operation time.	—

Reset of operation time of the compressor

4. Press the [▼] key. Displays screen for resetting the operation time of the compressor.

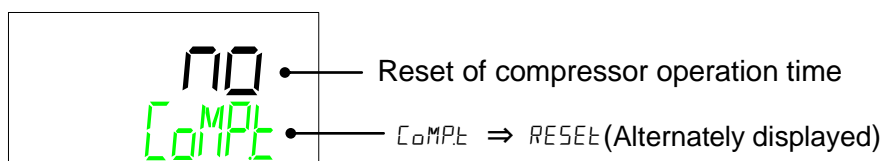

When the operation time of the compressor is reset, the operation time becomes “0 hour”.
When MT.02: Notice for compressor maintenance is generated, reset the notice for compressor maintenance.

Press “ENT” key when resetting the operation time of the compressor. When the display is flashing, press [▲], [▼] key and select “YES”. Then, press “ENT” key.

Set value	Contents	Initial value
no	Not reset.	○
YES	Resets the operation time of the compressor.	—

Reset of operation time of the fan

- 5.** Press the [▼] key. Displays screen for resetting the operation time of the fan.
 Displayed for air-cooled type only.

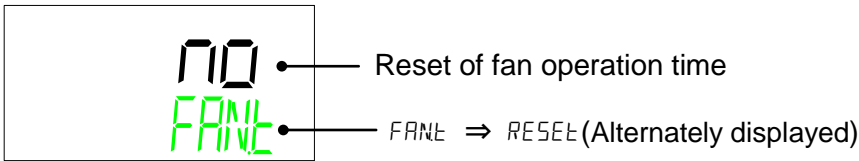

When the operation time of the fan is reset, the operation becomes “0 hour”.
 When MT.03: Notice for fan maintenance is generated, reset the the notice for fan maintenance.

Press “ENT” key when resetting the operation time of the fan. When the display is flashing, press [▲], [▼] key and select “YES”. Then, press “ENT” key.

Set value	Contents	Initial value
no	Not reset.	○
YES	Reset the operation time of the fan.	—

Reset of operation time of the dust-proof filter

- 6.** Press the [▼] key. Displays screen for resetting operation time of the dust-proof filter.
 Displayed for air-cooled type only.

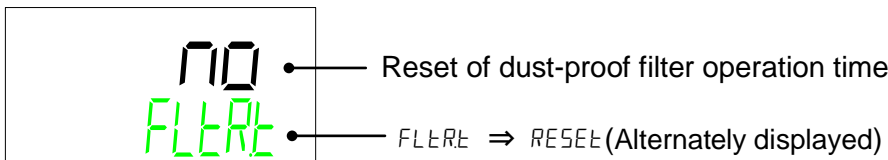

When the operation time of the dust-proof filter is reset, the operation time becomes “0 hour”.
 When MT.04: Notice of dust-proof filter maintenance is generated, reset the notice for dust-proof filter maintenance.

Press “ENT” key when resetting the operation time of the dust-proof filter. When the display is flashing, press [▲], [▼] key and select “YES”. Then, press “ENT” key.

Set value	Contents	Initial value
no	Not reset.	○
YES	Reset the operation time of the dust-proof filter.	—

Reset the operation time of the DI filter

- Press the [▼] key. Displays screen for resetting the operation time of the DI filter. Displayed for the option DM (Electric conductivity control type, de-ionized water piping type) only.

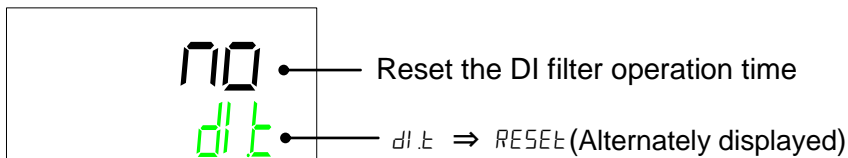

When the operation time of the DI filter is reset, the operation time becomes “0 hour”. When MT.05: Notice of DI filter maintenance is generated, reset the notice for DI filter maintenance.

Press “ENT” key when resetting the operation time of the DI filter. When the display is flashing, press [▲], [▼] key and select “YES”. Then, press “ENT” key.

Set value	Contents	Initial value
no	Not reset.	○
YES	Reset the operation time of the DI filter.	—

DI solenoid valve forced open

- Press the [▼] key. Displays screen for setting DI solenoid valve. Displayed for option DM (Electric conductivity control type, de-ionized water piping type) only. The DI solenoid valve can open or close while the operation is stopped.

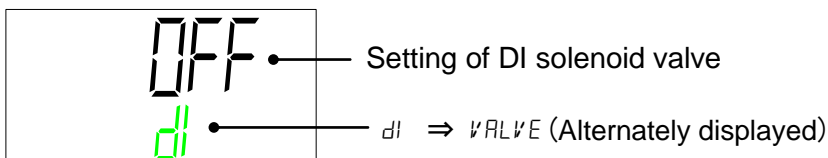

Press [ENT] key to set the DI solenoid valve when the operation is stopped. When the display is flashing, press [▲], [▼] key and select “YES”. Then, press “ENT” key.

Set value	Contents	Initial value
oFF	DI solenoid valve: CLOSE	○
on	DI solenoid valve: OPEN	—

5.5.7 Information Monitor Menu

Displays the product No, programme version, and operation times.

Information Monitor Menu TOP screen

1. When "MENU" key is pressed while Reset Menu TOP screen is displayed, the display is changed to the "Information Monitor Menu TOP screen".



Information Monitor Menu TOP screen

Product No.

2. Press the [▼] key. Displays Compressor output, Refrigeration Type and Thread for piping.



Series name "HRR"

"Compressor output", "Refrigeration Type" and "Thread for piping".

Power supply Option

3. Press the [▼] key. Displays "Power supply" and "Options".



Power supply

Option

4. Press the [▼] key. Displays serial number of the product.



Standard or special product number

Serial No.

Program No.

5. Press the [▼] key. Displays program number of the product.



Program No.

Program version

- 6.** Press the [▼] key. Displays program version of the product.

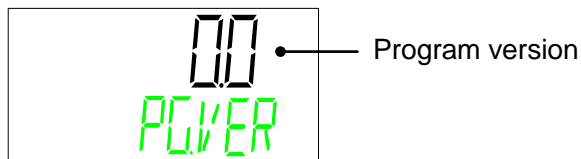

Operating time

- 7.** Press the [▼] key. Displays accumulated operating time of the thermo-chiller.

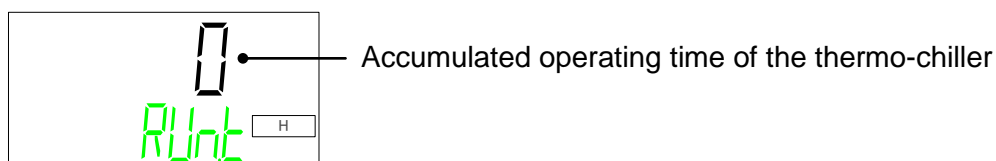

Operation time is accumulated up to 1,000,000 hour.
 Values are displayed alternately when exceeding 9999 hours.
 [Example of display]
 12,345 hour :1 ⇒ 2345 (alternately display)

Operation time of the pump

- 8.** Press the [▼] key. Displays accumulated operation time of the pump.

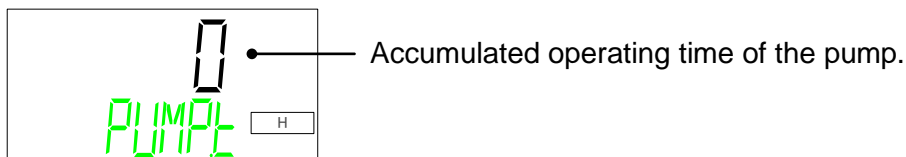

Operation time is accumulated up to 1,000,000 hour.
 Values are displayed alternately when exceeding 9999 hours.
 [Example of display]
 12,345 hour :1 ⇒ 2345 (alternately display)

Operation time of the compressor

- 9.** Press the [▼] key. Displays accumulated operating time of the compressor.

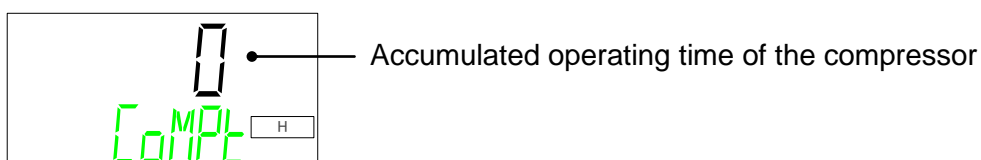

Operation time is accumulated up to 1,000,000 hour.
 Values are displayed alternately when exceeding 9999 hours.
 [Example of display]
 12,345 hour :1 ⇒ 2345 (alternately display)

Operation time of the fan

- 10.** Press the [▼] key. Displays accumulated operation time of the fan.
Displayed for air-cooled type only.

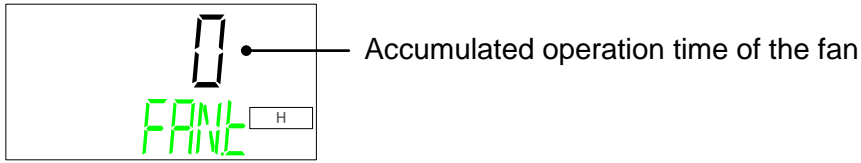

Operation time is accumulated up to 1,000,000 hour.
Values are displayed alternately when exceeding 9999 hours.

[Example of display]
12,345 hour :1 ⇒ 2345 (alternately display)

Operation time of the dust-proof filter

- 11.** Press the [▼] key. Displays accumulated operation time of the dust-proof filter.
Displayed for air-cooled type only.

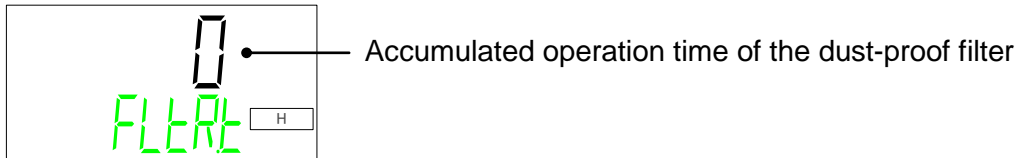

Length of operation is accumulated up to 1,000,000 hour.
Values are displayed alternately when exceeding 9999 hours.

[Example of display]
12,345 hour :1 ⇒ 2345 (alternately display)

Operation time of DI filter

- 12.** Press the [▼] key. Displays accumulated operation time of the DI filter.
Displayed for the option DM (Electric conductivity control type, de-ionized water piping type) only.

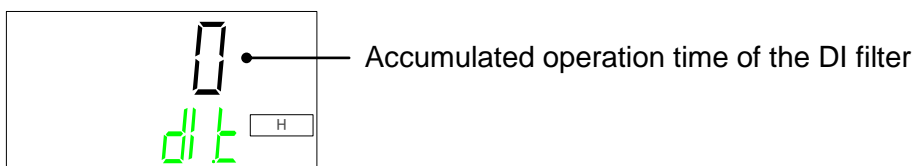

Length of operation is accumulated up to 1,000,000 hour.
Values are displayed alternately when exceeding 9999 hours.

[Example of display]
12,345 hour :1 ⇒ 2345 (alternately display)

Number of times of momentary power failure

- 13.** Press the [▼] key. Displays number of times of momentary power failure for the power supply to the product.

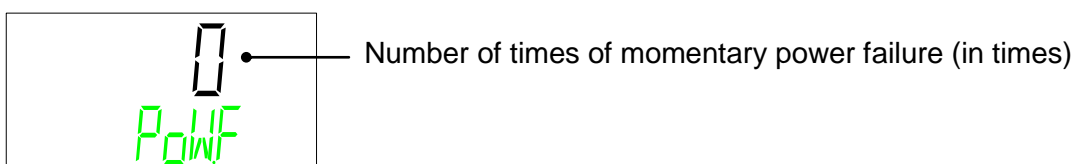

14. Press the [▼] key. Displays serial communication status.

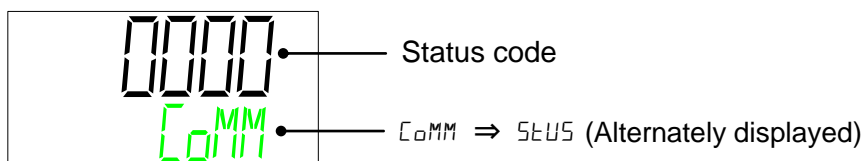

Refer to the table below for the status code.

Communication status code	Contents
8001	Normal message
4801	Number of data is different
4401	Data address is different
4201	FUNCTION is not supported
0101	Modbus format is different
0081	Slave address is different
0041	CRC is different
0021	LRC is different
0011	Chiller mode is ASCII but customer uses RTU.
0008	Communication condition is different (start bit/stop bit or communication speed is different).
0004	Communication condition is different (not even number parity)
0002	Overrun error
0000	Wiring or connection failure. Customer's message is not sent.

5.5.8 Alarm History menu

Displays the number of alarms and the accumulated time of energization when each alarm occurred. A maximum of 150 alarms are displayed.

When “MENU” key is pressed while Information Monitor Menu TOP screen is displayed, the display is changed to the “Alarm History menu TOP screen”.

Press [▼] key to display the latest alarm.

Older alarms are displayed by pressing [▼] key.

When [ENT] key is pressed while alarm is displayed, total time for energizing the product can be confirmed.

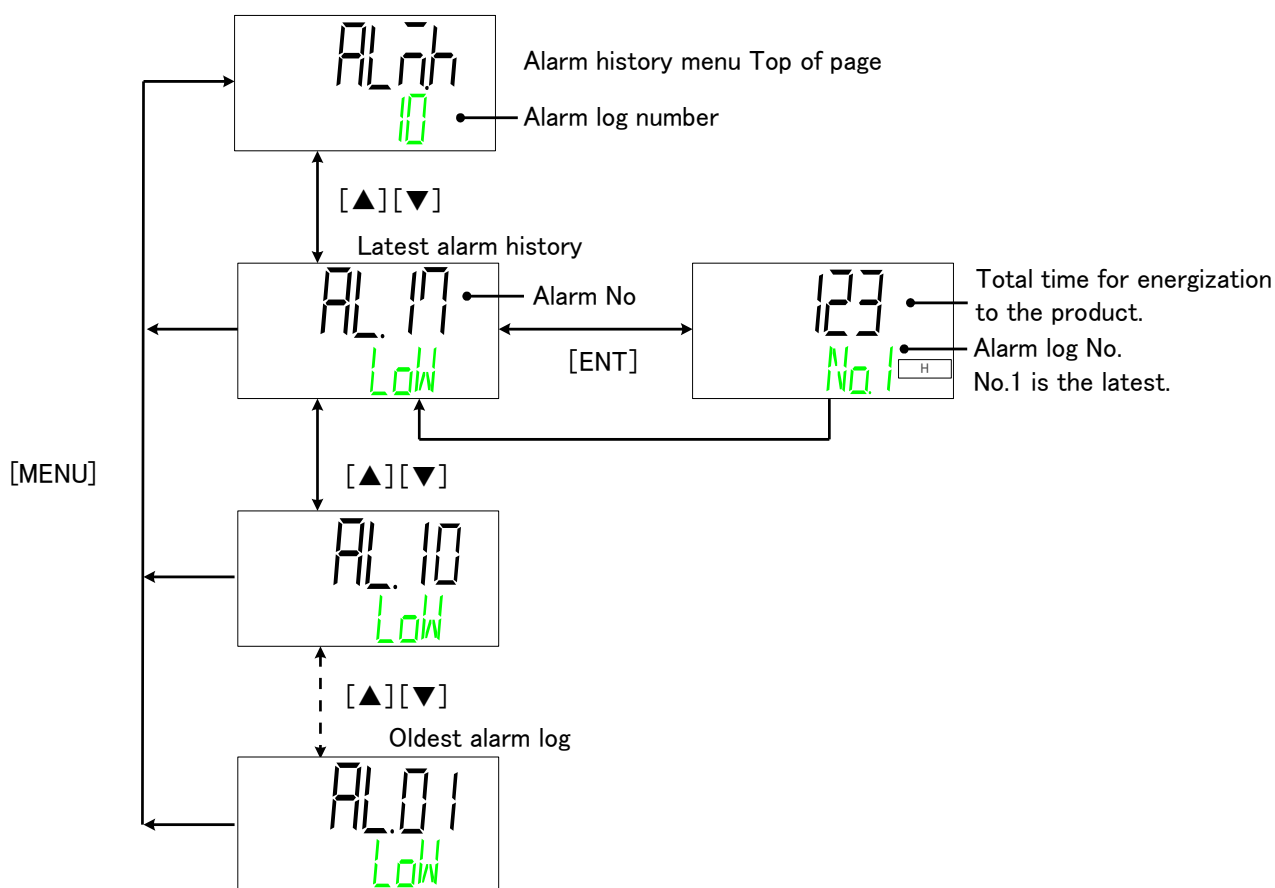

Chapter 6 Option

6.1 Option DM[Electric conductivity control function , DI water (pure water) piping]

6.1.1 Option DM[Electric conductivity control function , DI water (pure water) piping]

This function is available for customers who selected option DM(Electric conductivity control function , DI water (pure water) piping). By entering the set value of electric conductivity and hysteresis, flow of circulating fluid to the DI filter is controlled by the solenoid valve to control electric conductivity. The measurement range and setting range are as follows.

Measurement range of electric conductivity	0.1 to 48.0 μ S/cm
Set range of target electric conductivity	0.5 to 45.0 μ S/cm *1
Set range of electric conductivity hysteresis	0.1 to 10.0 μ S/cm

*1 Default setting is set to "Electric conductivity set value: 25.0 μ S / cm" and "hysteresis: 5.0 μ S / cm"

Example of operation of electric conductivity control

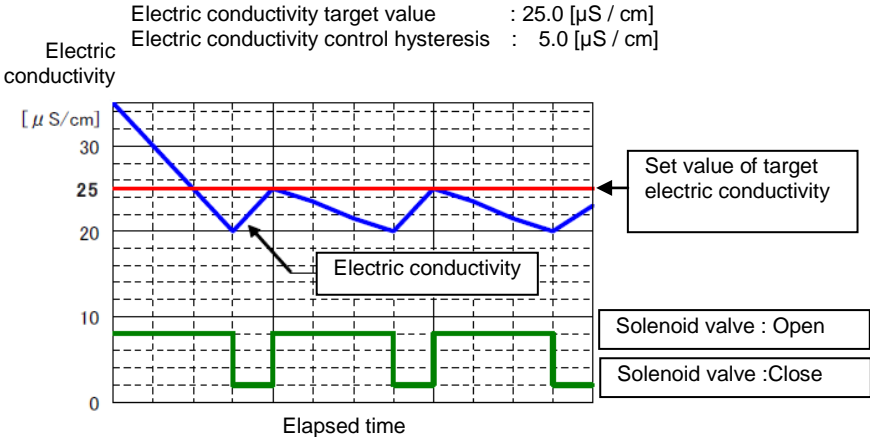

The solenoid valve for electric conductivity control can be made normally open/normally closed. (This function is available in operation.)

Content	Content of selection	solenoid valve control	Default setting
Electric conductivity control method	CTRL	The solenoid valve opens and closes and conductivity is controlled.	○
	OPEN	The solenoid valve normally open	—
	CLOSE	The solenoid valve normally closed	—

6.2 Option M【DI water (Pure water) piping】

6.2.1 Option M【DI water (Pure water) piping】

This option is for customers who use DI water (pure water) as circulating fluid.

Circulating fluid wetted materials	Stainless (include heat exchanger brazing), Aluminum oxide ceramic, SiC, Carbon, PP, PE, POM, FKM, EPDM, PVC (No. copper used)
------------------------------------	--

This M option does not have electric resistance/ electric conductivity control function.If this function is necessary, option DM 【Electric conductivity control function, DI water(Pure water piping)】 should be choose.

6.3 Option T【High-pressure pump mounted】

6.3.1 Option T【High-pressure pump mounted】

With option T (high pressure pump mounted), the discharge pressure is increased.

- The high head pump uses a mechanical seal.
- The recommend life time of the mechanical seal before needing replacement is 6000 to 8000 hours.

Applicable model			HRR012/018-A/W-10-T/MT	HRR012/018/024/030-A/W-20-T	HRR012/018/024/030-A/W-20-MT ^{Note1)}
Pump	Rated flow (50/60Hz) <small>Note2)3)</small>	L/min	7(0.36MPa)/10(0.42MPa)	10(0.42MPa)/14(0.40MPa)	10(0.32MPa)/14(0.32MPa)
	Maximum pumphead (50/60Hz)	m	50	50	50
	Output	W	320	550	
Circuit protector	A	15	15A (10A for standard)		
Recommended earth leakage breaker capacity	A	15			
Cooling capacity ^{Note 4)}	W	The cooling capacity reduces about 300W from the value in the catalog. (due to an increase in heat generation of the pump)			

Note 1) -MT:Applicable to DI water piping + High pressure pump

Note 2) The capacity at the thermo-chiller outlet when the circulating fluid temperature is 20°C.

Note 3) Required minimum flow rate for cooling capacity or maintaining the temperature stability.

Note 4) Cooling capacity will decrease as pump power increases.

*When the option,high pressure pump mounted, is selected, the product weight is increased by 5kg.

*No change in external dimensions of this product.

*Notice on mechanical seal replacement.

Mechanical seal replacement is limited to 2 times. If the cumulative operation time of the pump exceeds 20,000 hours, please consider requesting pump inspection service.

6.4 Option T1【Inverter pump mounted】

6.4.1 Option T1【Inverter pump mounted】

- For option T1, the pump output set value can be changed.
- This pump has a sealless structure.

Applicable model			HRR012/018/024/030-A/W-T1
Pump	Rated flow (50/60Hz) ^{*1}	L/min	10 (0.28MPa)
	Maximum pump head (50/60Hz) ^{*2}	m	40
	Output	W	400
Circuit protector		A	15
Recommended earth leakage breaker capacity		A	15
Cooling capacity ^{*3}		W	The cooling capacity reduces about 300W from the value in the catalog. (due to an increase in the heat generation of the pump)

*1 Required minimum flow rate for maintaining the cooling capacity or temperature is 20°C

*2 The capacity at the thermos-chiller outlet when the circulating fluid temperature is 20°C.

*3 Cooling capacity will decrease as pump power increases.

* When the option, inverter pump mounted, is selected, the product weight decrease by 1kg.

* No change in external dimensions of this product.

6.5 Option Y【With feet and no Rack Mounting bracket】

6.5.1 Option Y【With feet and no Rack Mounting bracket】

Rack mounting brackets are removed as they are not necessary when the product is not mounted in a rack. This option has rubber feet for installing the product on the floor.

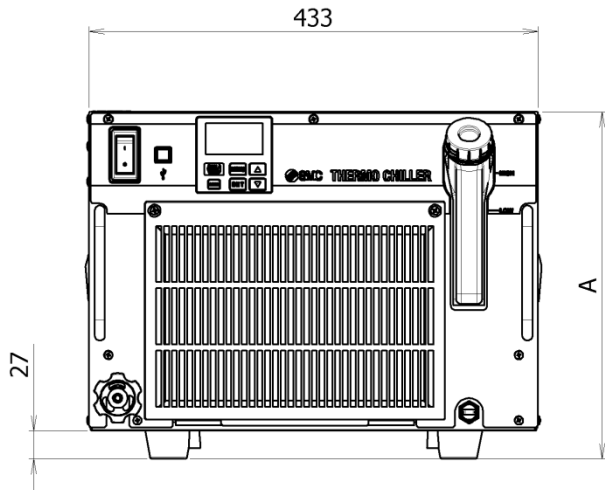

Model number	Height [mm]
	A
HRR012/018-A/W-10/20-Y	334
HRR024/030-A/W-20-Y	423

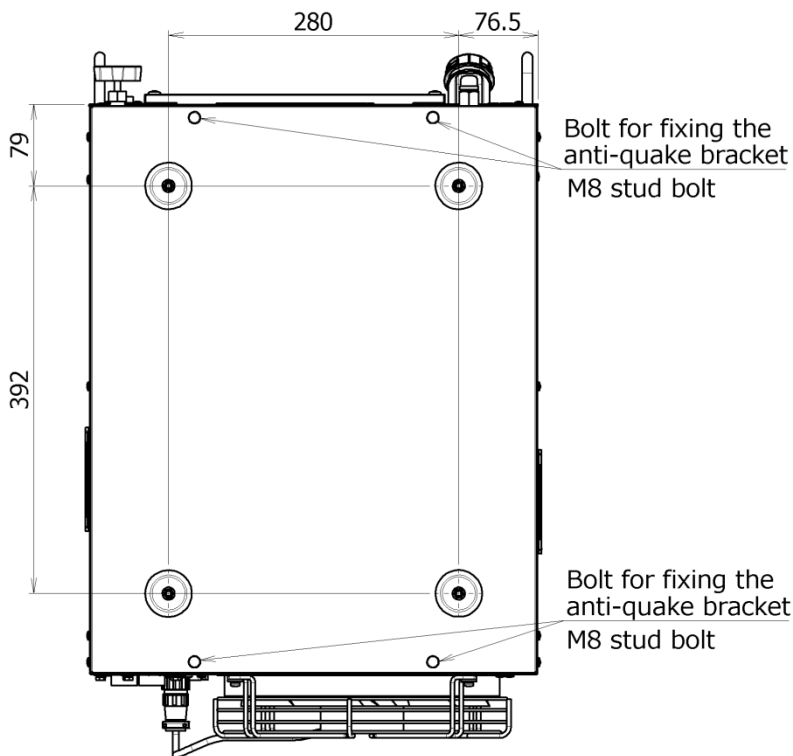
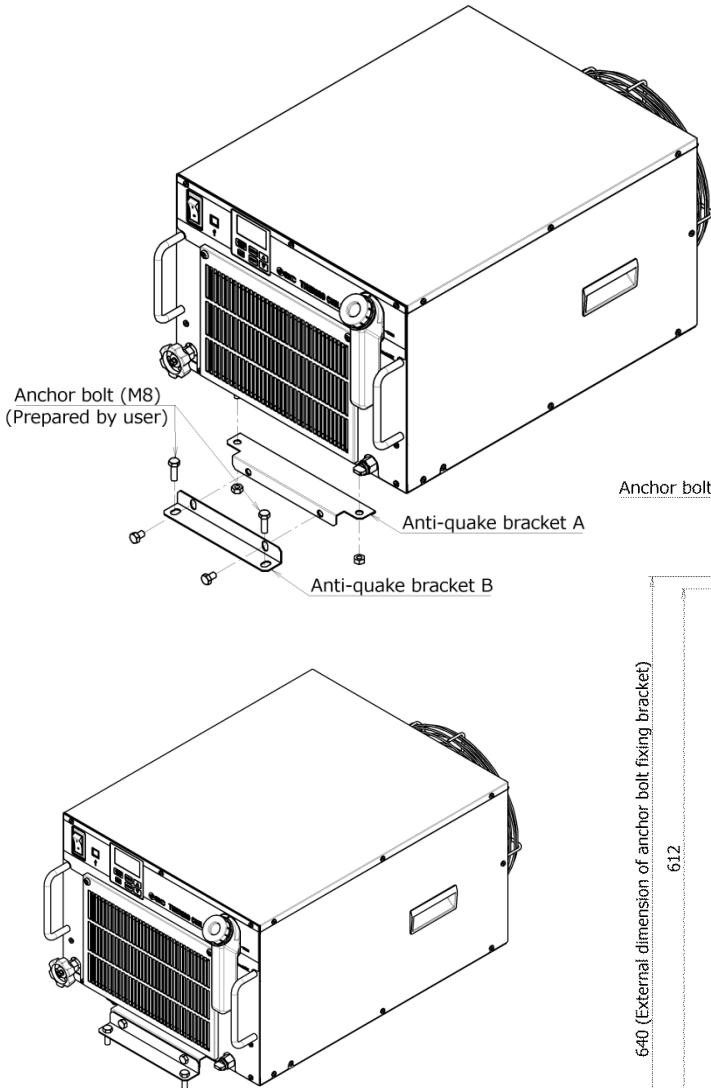

Fig. 6-1 Option Y 【With feet and no Rack Mounting bracket】 (Option Y)

6.5.2 Anti-quake bracket (Optional Accessories)

- Bracket for earthquakes.
- Only when option Y is selected, this brackets can be mounting. This brackets can not be mounting to products other than option Y.
- Anchor bolt (M8) suitable for the flooring material should be prepared separately by user. (Anti-quake bracket material : stainless, thickness: 1.5mm)

Part no.	Description	Qty	Applicable model
HRR-TK001	Anti-quake bracket A	2	HRR012/018-A/W-10/20-Y
	Anti-quake bracket B	2	
	Nut (M8)	4	HRR024/030-A/W-20-Y
	Bolt (M8)	4	



Fit it on the opposite side similarly

Mounting of anti-quake bracket

1. Remove the cap from M8 stud bolt. (4pcs)
2. Mount the anti-quake bracket A. (Recommended torque : 12.5Nm)
3. Mount the anti-quake bracket B. (Recommended torque : 12.5Nm)

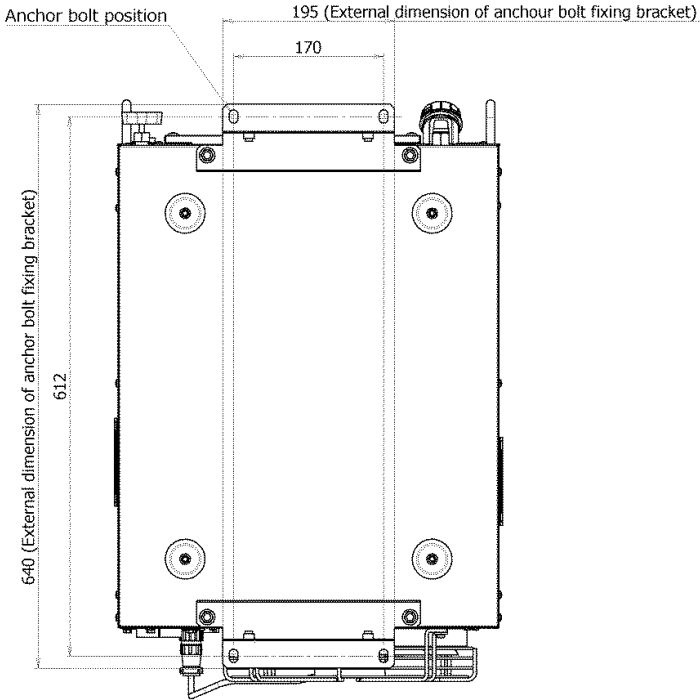

Fig. 6-2 Mounting the anti-quake bracket and Anchor bolt fixing position

6.6 Option Z【Removed Parts】

6.6.1 Option Z【Removed Parts】

It is a specification with the following parts removed.

- Bypass valve
- Flow sensor
- Particle filter
- Water leakage sensor
- Retaining clip

When this option is selected, the following functions cannot be used.

- Flow rate display
- Alarm “AL04: Water leakage”
- Alarm “AL10: Flow rate decreased”
- Alarm “AL17: Low flow rate*”

6.6.2 Option Z1【Removed Parts】

It is a specification with the following parts removed.

- Flow sensor
- Retaining clip

When this option is selected, the following functions cannot be used.

- Flow rate display
- Alarm “AL10: Flow rate decreased”
- Alarm “AL17: Low flow rate*”

* For models with options T1 and Z or T1 and Z1, the alarm will occur.

Chapter 7 Alarm Notification and Troubleshooting

7.1 Alarm Notification

When any alarm occurs, the product responds with the following conditions.

- The [ALARM] (“ALM”, “WRN”) light blinks.
- The alarm buzzer sounds.
- The alarm number is displayed in the upper level window on the digital display.
(If alarm has occurred more than one, alarm number of latest occurred alarm is displayed.)
- Contact signal of contact input/output communication is output. Refer to the Operation Manual for communication for details.
- It is possible to read the alarm status using serial communication. Refer to the Operation Manual for communication for details.
- This product makes two type action depend on generated alarm.

Depending on the alarm content, this product stops operation. “ALM” lamp will light. (Operation can not resume unless the alarm is reset.)

Depending on the alarm content, this product will continue operation. “WRN” lamp will light.

Refer to the “Table 7-1 Alarm code list and troubleshooting”. When the operation stops due to the alarm, it is not possible to restart the operation until the alarm is reset.

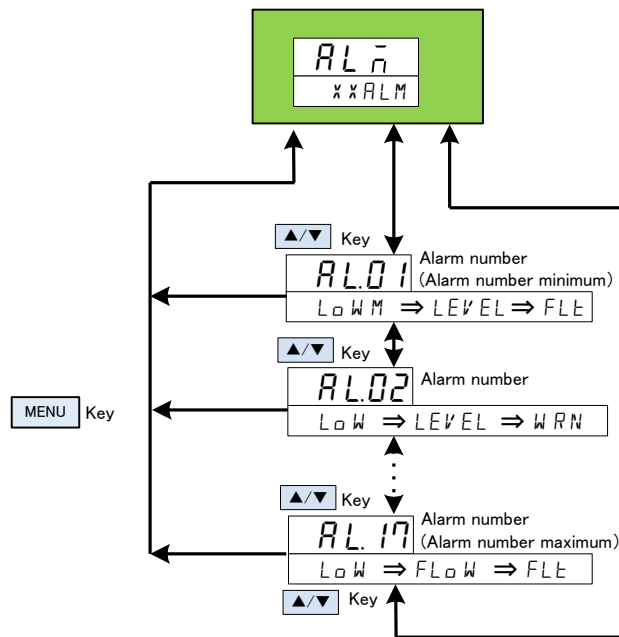

Fig. 7-1 Screen display of when an alarm occurs

- * [] light turns ON only when “AL01 Low level in tank abnormal”, “AL02 Low level in tank” alarm is being generated.

- When multiple alarms are generated, the alarm codes are displayed one by one by pressing the [▲ / ▼] key.

Press the [MENU] key to display the TOP screen of the alarm menu.



7.2 Alarm Buzzer Stop

The alarm buzzer sounds to notify when the alarm signal is output. How to stop the alarm buzzer.

- Ensure that the alarm display screen is displayed.

The alarm buzzer can only be stopped on this screen.

- Press the [RESET] key.
- The alarm buzzer is stopped.

(Tips)

- The alarm buzzer can be set not to make sound. Refer to “P.5-20 Alarm buzzer sound”. The procedure to stop the alarm buzzer is not necessary when the buzzer is set not to make a sound.
- If this procedure is performed when the cause of the alarm has been eliminated before stopping the alarm buzzer, the alarm will be reset at the same time.

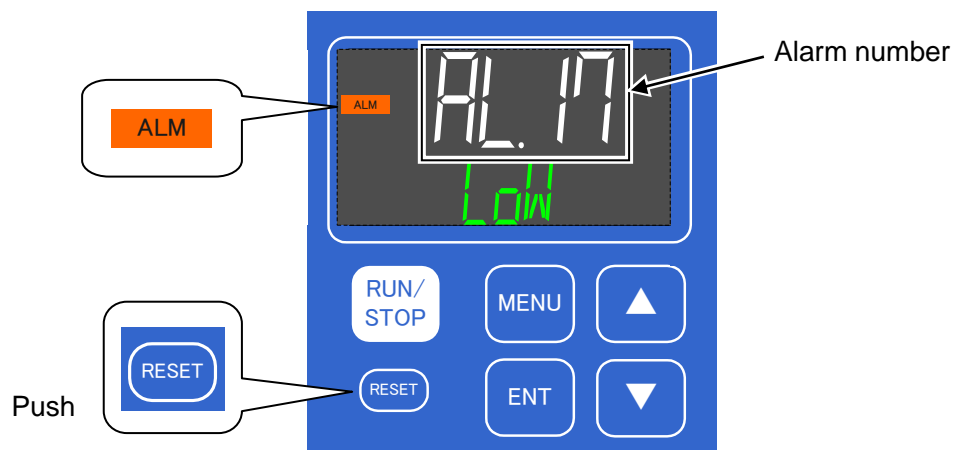

7.3 Troubleshooting

7.3.1 Alarm contents, causes, and troubleshooting

The troubleshooting method depends which alarm has been generated. Refer to "Table 7-1 Alarm code list and Troubleshooting"

This page explains how to reset the alarm signal condition after eliminating the cause of the alarm.

- Ensure that the alarm display screen is displayed.
Alarm can only be reset on this screen.
- Press [RESET] key.
- The alarm is reset, and the [ALARM] ("ALM", "WRN") light turns OFF.
- The circulating fluid temperature display screen (main menu TOP screen) is displayed.
- Contact signal output for contact input/output communication stops. (Refer to the Operation Manual for communication for details.)

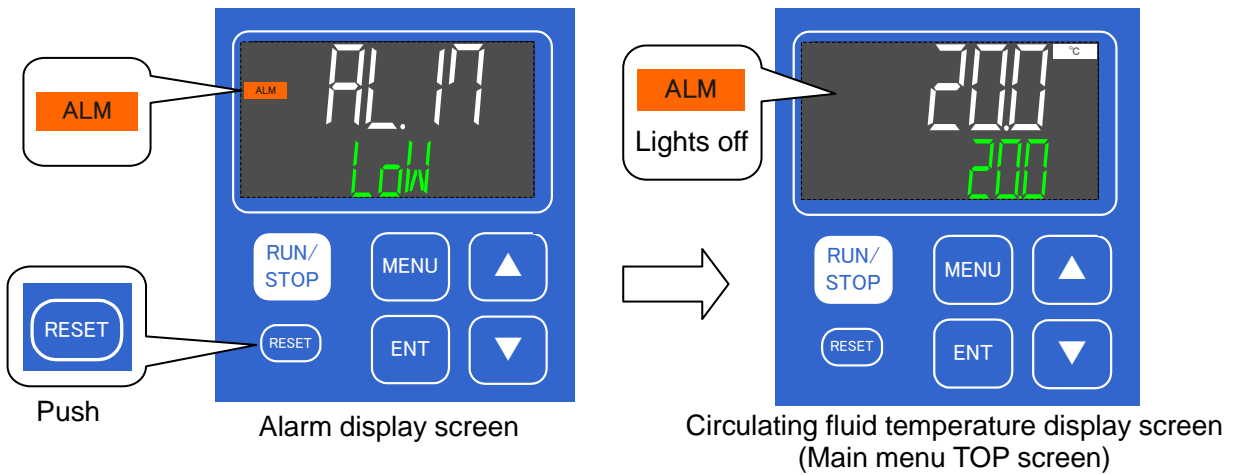

Table 7-1 Alarm code list and Troubleshooting

Alarm No.	Description	Initial value	Display unit		Cause / Remedy (Press the reset key after eliminating the cause.)
			Upper stage (White)	Lower stage (Green)	
AL01	Low level in tank	FLT	AL01	LOW⇒LEVEL⇒FLT	Fluid level shown by the fluid level meter has fallen.
AL02	Low level in tank	WRN	AL02	LOW⇒LEVEL⇒WRN	Add circulating fluid.
AL04	Water leakage ^{*1}	WRN ^{*2}	AL04	WATER ⇒ LEAK	Circulating fluid leakage inside the unit is suspected.
AL05	Pump Inverter error ^{*3}	WRN	AL05	PUMP ⇒ INV	Check the installation environment. Clean the dust filter of the ventilation.
AL06	Internal fan stop ^{*4}	WRN	AL06	FAN ⇒ ERROR	Check for fan rotation.
AL09	Circulating fluid discharge pressure rise	FLT ^{*5}	AL09	HIGH ⇒ PRESS	Piping resistance increased. Check the opening of the valve, pinching or blockage of the piping or clogging of the filter.
AL10	Flow rate decreased ^{*6}	WRN ^{*2}	AL10	LOW⇒FLOW⇒WRN	
AL11	Ambient temperature is out of the range ^{*7}	OFF ^{*2}	AL11	AMB⇒TEMP⇒OUT	Check the installation environment. Clean the dust filter of the ventilation.
AL12	Electric conductivity increase ^{*8}	WRN ^{*9}	AL12	DI ⇒ ERROR	Replace DI filter.
AL13	NOT TEMP READY	OFF ^{*2}	AL13	TEMP⇒READY⇒ERROR	Overloaded, cooling failure, insufficient circulating fluid flow rate, large fluctuation of the heat load, etc. Increase the flow rate through the chiller. (Adjust the by-pass valve)
AL14	Circulating fluid temperature increase	OFF ^{*2}	AL14	TEMP⇒OUT.HI	
AL15	Circulating fluid temperature decrease	OFF ^{*2}	AL15	TEMP⇒OUT.LO	
AL17	Low flow rate ^{*10}	FLT ^{*2}	AL17	LOW⇒FLOW⇒FLT	Displayed flow rate: 2LPM or less, piping is thin, external valve is closed, pinching or blockage of the piping or clogging of the filter.
AL18	High circulating fluid discharge temp.	FLT	AL18	TEMP ⇒ FLT	Discharge temp.: 45°C or higher. Overload, cooling failure, insufficient flow rate, etc. Increase the flow rate through the chiller. (Adjust the by-pass valve)
AL19	High circulating fluid return temp.	FLT	AL19	RET⇒TEMP⇒FLT	Return temp.: 45°C or higher. Insufficient chiller flow rate, overload, etc. Increase the flow rate through the chiller. (Adjust the by-pass valve)
AL21	High circulating fluid discharge pressure	FLT	AL21	HIGH⇒PRESS⇒FLT	Displayed pressure: 0.6MPa (For option T1, 0.45MPa) or higher. Connect piping so that the pressure is 0.5MPa (For option T1, 0.4MPa) or less. Adjust the bypass valve.
AL22	Low circulating fluid discharge pressure	FLT	AL22	LOW⇒PRESS⇒FLT	Displayed pressure: 0.03MPa or less. Check that the pump has not stopped.
AL24	Memory error	FLT	AL24	MEM ⇒ ERROR	Turn off the power supply switch and restart. If the error occurs again, ask for service.
AL25	Contact input 1 signal detection	FLT ^{*2}	AL25	INP1 ⇒ ERROR	Contact input has been detected.
AL26	Contact input 2 signal detection	FLT ^{*2}	AL26	INP2 ⇒ ERROR	
AL27	Forced stop	FLT	AL27	FORCE ⇒ STOP	Time for pump to continue operation is stopped (press "RUN/STOP" key for 5 seconds).
AL28	Notice for maintenance	OFF ^{*2}	AL28	MANT ⇒ ALARM	Notice for maintenance, perform maintenance for part for which alarm is generated.
AL29	Communication error	WRN ^{*2}	AL29	COMM ⇒ ERROR	No request message from the host computer. Try to send the request message again.
AL30	Compressor circuit error	FLT	AL30	REF⇒ERROR⇒0000	Error occurred in the refrigerated circuit. Ask for service.
AL31	Sensor error	FLT	AL31	SENS⇒ERROR⇒0000	An error occurred in a sensor. Ask for service.
AL32	Controller error	FLT	AL32	CTRL⇒ERROR⇒0000	An error occurred in the controller. Ask for service.

*1 Not generated for options Z.

*2 Select from OFF / WRN / FLT.

*3 Only option T1.

*4 Only water-cooled type and option T1.

*5 Select from WRN / FLT.

*6 Not generated for options Z and Z1.

*7 Only air-cooled type.

*8 Only option DM. Alarm is automatically released when the electric conductivity returns within the range.

*9 Select from OFF / WRN.

*10 Not generated for options Z and Z1. However, for models that include both options T1 and Z or Z1, it occurs at 7L/min or less.

7.4 Other Errors

■ How to check other errors

The causes and remedies for failures that are not indicated by alarm numbers are shown in "Table 7-2"

Table 7-2 Causes and remedies for failures without alarm number

Content of failure	Cause	Remedy
The operation panel displays nothing	The power supply switch is not turned on.	Turn on the power supply switch.
	Failure of power supply switch	Replace the power supply switch.
	No power supply (The breaker for the power supply is not turned on.)	Supply the power.
	Trip of breaker due to short-circuit and current leakage	Repair the short-circuit or current leaking part.
The [RUN] LED does not light up even when the [RUN/STOP] switch is pressed.	Communication is set.	Check the presence of communication setting.
	Failure of the [RUN] LED	Replace the controller.
	Failure of the [RUN/STOP] switch	Replace the controller.

Chapter 8 Control, Inspection, Exchange and Cleaning

8.1 Quality Control of Circulating Fluid and Facility Water

⚠ WARNING



Use specified fluids only. If other fluids are used, they may damage the product, causing fluid leakage, or result in hazards such as electric shock or leakage of electricity.
When using clear water (tap water), ensure that it satisfies the water quality criteria shown in the table below.

Table 8-1 Quality criteria for clean water (tap water)

	Item	Unit	Criterion	
			Circulating fluid	Facility water
Standard item	pH (at 25 °C)	—	6.0 to 8.0	6.5 to 8.2
	Electric conductance (at 25 °C)	[μS/cm]	100 to 300	100 to 800
	Chloride ion	[mg/L]	50 or less	200 or less
	Sulfuric acid ion	[mg/L]	50 or less	200 or less
	Acid consumption (at pH 4.8)	[mg/L]	50 or less	100 or less
	Total hardness	[mg/L]	70 or less	200 or less
	Calcium hardness	[mg/L]	50 or less	150 or less
	Ion silica	[mg/L]	30 or less	50 or less
Referential item	Iron	[mg/L]	0.3 or less	1.0 or less
	Copper	[mg/L]	0.1 or less	0.3 or less
	Sulfide ion	[mg/L]	Not detected	Not detected
	Ammonium ion	[mg/L]	0.1 or less	1.0 or less
	Residual chlorine	[mg/L]	0.3 or less	0.3 or less
	Free carbon dioxide	[mg/L]	4.0 or less	4.0 or less

* Quoted from the standard "JRA-GL-02-1994", The Japan Refrigeration and Air Conditioning Industry Association.

CAUTION



Replace the circulating fluid and/or the facility water if any problems are found in the regular check. Even if no problems are found, some of the water in the tank evaporates and impurity concentration in the circulating fluid increases. Replace the circulating fluid on the tank once in every 3 months. Refer to the section "8.2 Inspection, Exchange, Cleaning" for regular inspection.

8.2 Inspection, exchange, cleaning

⚠ WARNING



- Do not perform key operation or setting of this equipment with wet hands. Do not touch the electrical parts such as the power supply plug. It may cause an electric shock.
- Do not splash water directly on the product or do not wash with water. It might cause electric shock, fire, or etc.

⚠ WARNING



- Shut off the power supply to this product before performing cleaning, maintenance or inspection, or it may cause electric shock, injury, burn, or etc.
- When the panel has been removed for the purpose of inspection or exchange or cleaning, mount the panel after the work is completed. If the product is operated with the panel removed or open, it may cause injury or electric shock.

8.2.1 Daily check

Check the items listed below. If any abnormality is found, stop the operation of the product and turn the power supply OFF, and ask for service.

Table 8-2 Daily check items

Item	Contents of check	
Installation condition	Check the installation conditions of the product.	<ul style="list-style-type: none"> • Check that there is no heavy object on the product or excessive force applying to the piping. • Temperature should be within the specification range of the product. • Make sure the ventilation grille is not obstructed. (For air-cooled typ)
Fluid leakage	Check the installation conditions of the product.	Check that there is no fluid leakage from the connected parts of the piping.
Amount of circulating fluid	Check the liquid level indicator.	Fluid level should be between "HIGH" and "LOW" levels of the fluid level meter.
Operation panel	Check the indications on the display.	The numbers shown on the display should be clear and legible.
	Check the functionality.	Check that the keys, [RUN/STOP], [MENU], [ENT], [▼], and [▲], operate correctly.
Circulating fluid temperature	Check on the operation panel.	There should be no problem for operation.
Circulating fluid discharge pressure	Check on the operation panel.	There should be no problem for operation.
Circulating fluid flow rate	Check the operating condition of the product (except option Z, Z1)	There should be no problem for operation. If the flow rate is decreasing, check the particle filter for contamination, and if it is dirty, replace the element.

Operating condition	Check the operation condition.	<ul style="list-style-type: none"> • There should be no abnormality with noise, vibration, smell, or generation of smoke. • There should be no active alarm signal.
Facility water (for water-cooled type)	Check the facility water condition.	<p>Temperature, flow rate and pressure are within the specified range.</p> <p>If the flow rate is decreasing, the Y type strainer</p> <p>Check clogging and clean the strainer.</p>
Ventilating condition (for Air-cooled type)	Check the condition of the ventilation grille.	<ul style="list-style-type: none"> • Make sure the ventilation grille is not obstructed.

8.2.2 Monthly check

Table 8-3 Contents of monthly check

Item	Contents of check	
Ventilating condition (air cooled type)	Clean the ventilating grilles.	Make sure the ventilating grilles are not clogged with dust, etc.
Facility water (water cooled type)	Check the facility water.	Make sure the facility water is clean and contains no foreign matter.

■ Cleaning of air ventilation port (Air cooled type.)

CAUTION



The dustproof filter at the ventilation inlet clogged with dust or debris, heat radiation performance declines. This will result in the reduction of cooling performance, and may stop the operation because the safety device is triggered.

■ Removal of the dust-proof filter

1. The dust proof filter is installed inside of filter panel in front of this product.
-
2. Loosen filter panel holding screws by using cross slot screw driver.

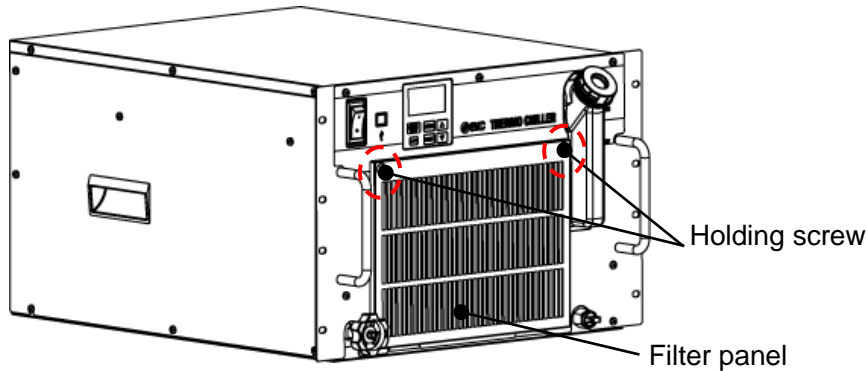

Fig. 8-1 Removal of the Filter panel

3. There is a dustproof filter inside the filter panel. Remove the dustproof filter.

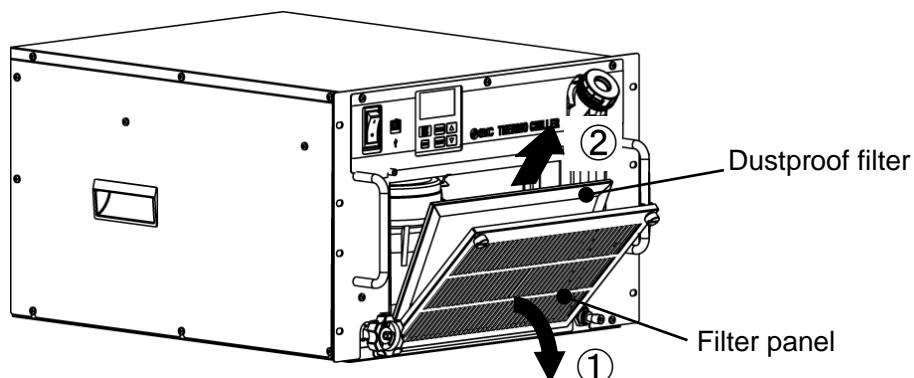

Fig. 8-2 Removal of the dust-proof filter

■ **Cleaning filter**

Clean the filter with a long bristled brush or by air blow.

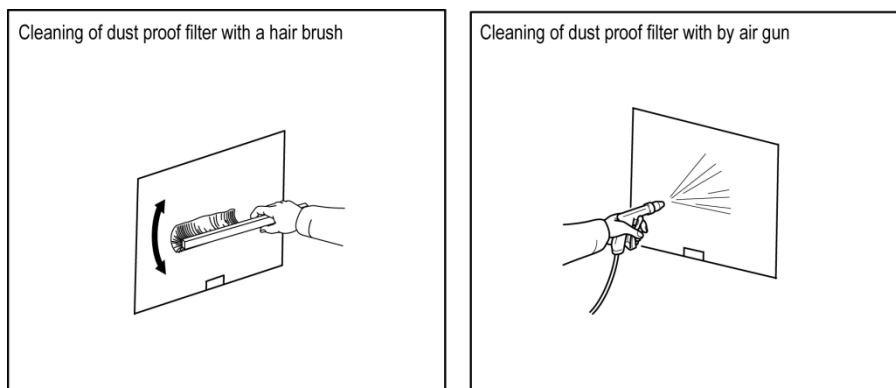

Fig. 8-3 Cleaning of the dust-proof filter

■ **Mounting of the dust-proof filter**

Reassemble the filters in the reverse order to the removing procedure.
 (Recommended tighten torque of filter panel holding screws: 1.5 N · m)

8.2.3 Inspection every 3 months

Table 8-4 Contents of every 3 months check

Item	Contents of check	
Power supply	Check the power supply voltage.	- Make sure the supply voltage is within the specification range.
Circulating fluid	Replace the circulating water (clean water) periodically.	- Ensure that the water has not been contaminated and that there is no algae growth. - Circulating water inside the tank must be clean and there must not be foreign matter inside. - Use clean water or pure water. The water quality must be within the range shown in Table 8-1. * It is recommended to replace the circulating fluid every 3 months when periodic maintenance is performed.
	Density control (When using 15% concentration ethylene glycol aqueous solution)	- Density must be within the range of 15 % +5/-0.
Facility water (For water-cooled type)	Check the water quality.	- Ensure that the water is clean and contains no foreign matter. Also check that the water has not been contaminated and there is no algae growth. - The water quality must be within the range shown in Table 8-1.

■ Replacement of circulating fluid

- Replace the circulating fluid with new clean fluid periodically, or it may get algae or decompose.
- Circulating fluid to be supplied in the tank should satisfy the water quality specified in "Table 8-1: Quality criteria for clean water (tap water)".
- Make sure that the concentration of ethylene glycol aqueous solution is 15%+5/0 when 15% ethylene glycol solution is used .
- If the particle filter element is dirty, replace the element. (See 8.4.1 Replacing Particle Filter.)

■ Cleaning of the facility water system (Water cooled type)

- Clean the customer's facility water system and replace facility water.
- Facility water quality must satisfy the criteria specified in "Table 8-1 Quality criteria for clean water (tap water)"
- Check the strainer and clean it if it is dirty. (Refer to "Cleaning of Y - strainer".)

CAUTION

 If there is foreign matter accumulated or clogging in the facility water system, pressure loss increases with less flow rate, and it may damage the screen mesh.

■ Cleaning of Y- strainer

When cleaning Y-strainer, facility water must be discharged.
Please refer to "8.3.2 Discharge of the facility water".

WARNING



- Before discharging the facility water, stop operation of the user's equipment and release the residual pressure.
- Wear protective equipments like gloves to avoid getting injure like a cutting hand by sharp edge of panel

- 1.** Discharge the facility water. Please refer to "8.3.2 Discharge of the facility Water".
- 2.** The strainer is installed on the back of the product.
Remove the strainer using a tool such as a spanner.
When removing the strainer, product should be fixed to do not move.

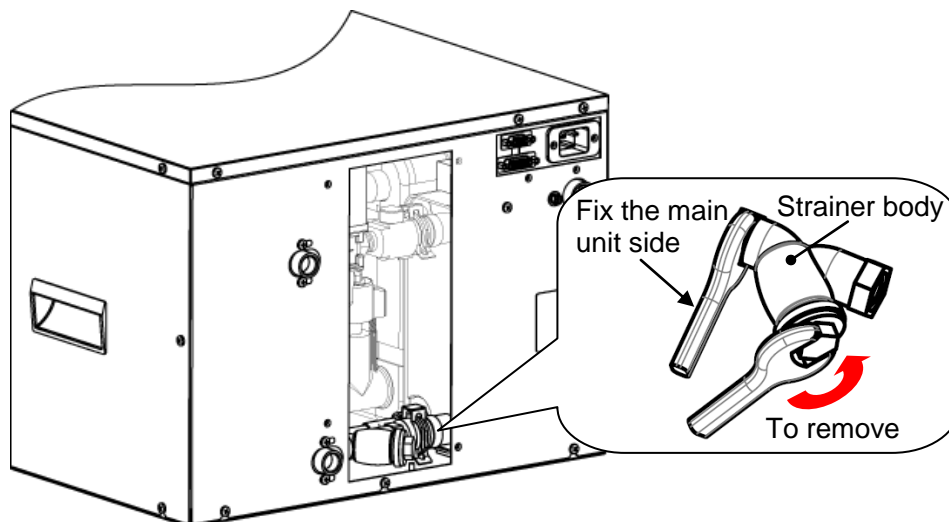

- 3.** Clean the strainer.

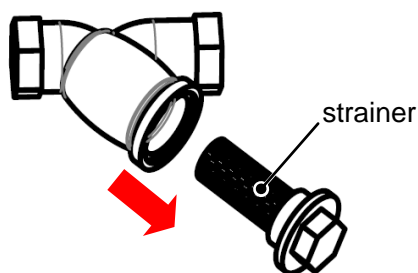

- 4.** After cleaning, please install the strainer by the reverse procedure.
- 5.** Install the cover panel.

8.2.4 Inspection every 6 months

■ Check for water leakage from pump (For option T [High head pump])

Remove the filter panel and check the pump for excessive leakage. If the leakage is found, replace the mechanical seal.

CAUTION

- Leakage from the mechanical seal
It is impossible to prevent the leakage from the mechanical seal completely because of its structure. Although the leakage is described as 3cc/hr or less.
- The recommend life time of the mechanical seal before needing replacement is 6000 to 8000 hours (usually 1 year)

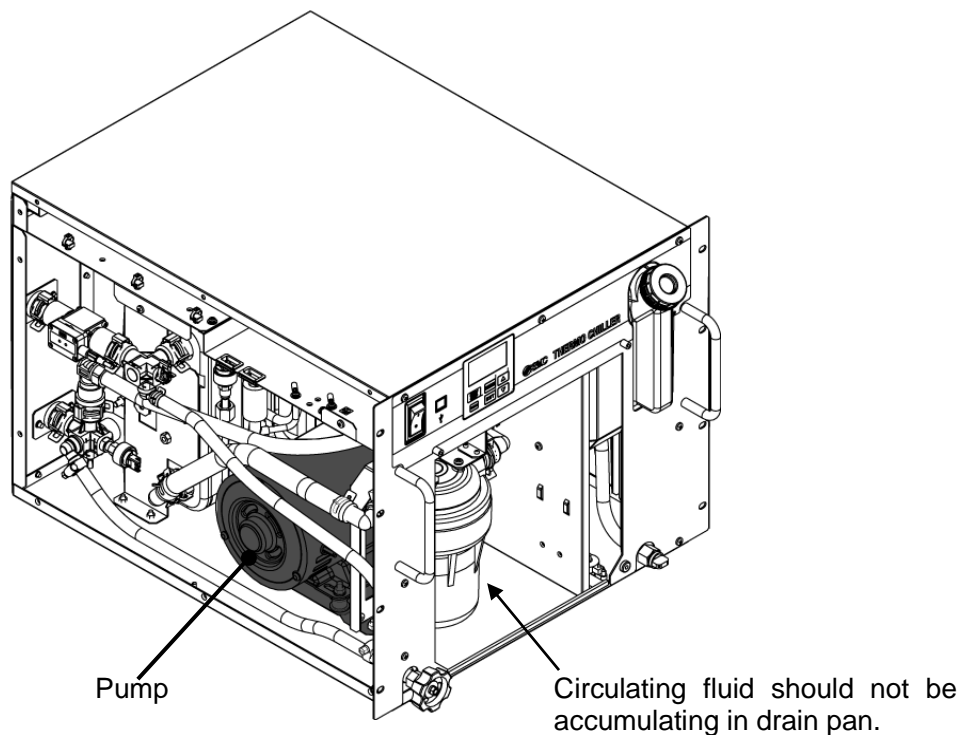

Fig. 8-4 leak check

8.3 Stop for a Long Time

If there is a concern that the product will not be operated for a long period of time or there is a risk of freezing, conduct the following operations.

1. Turn off the user's power supply (breaker). Turn off the power switch of this product.
2. Drain the circulating fluid of the product completely.
Please refer to 「8.3.1 Discharge of the circulating fluid」for the method of drain the circulating fluid from the product.
3. After draining, cover the product with vinyl, etc. and store.

8.3.1 Discharge of the circulating fluid

⚠ WARNING



- Stop the customer device and release the residual pressure before discharging the circulating fluid.
- Wear protective equipments like gloves to avoid getting injure like a cutting hand by sharp edge of panel.

1. Shut off the user's power supply (breaker). Turn off the power switch of this product.
2. Remove the plug from drain port and discharge circulating fluid.
By opening tank cap will make it easy.

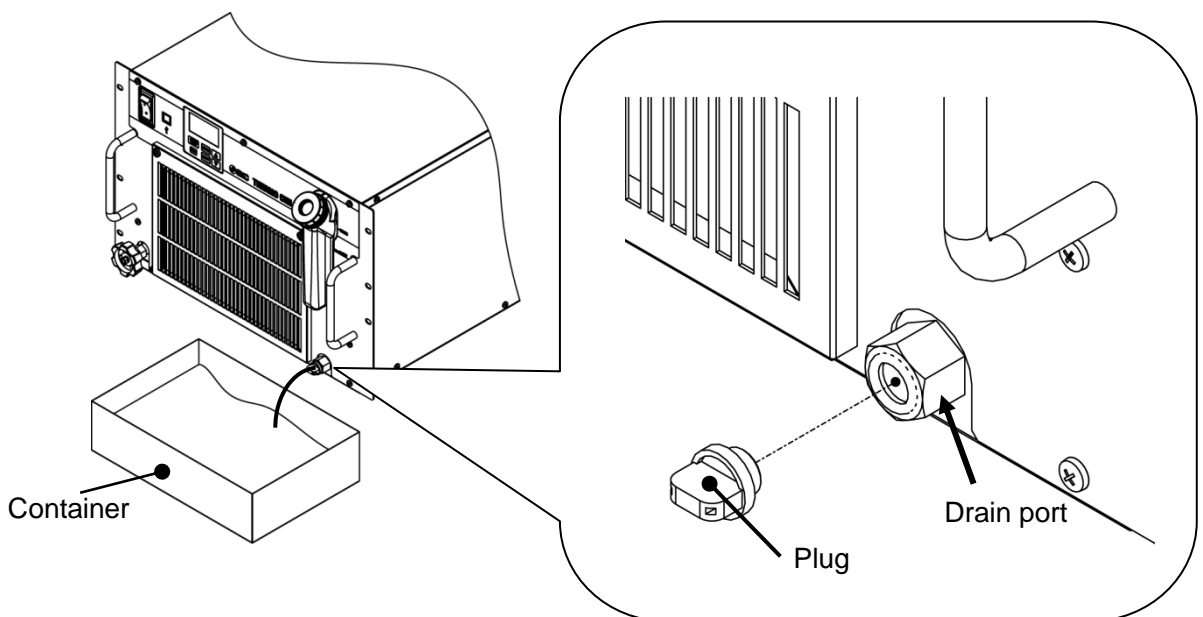
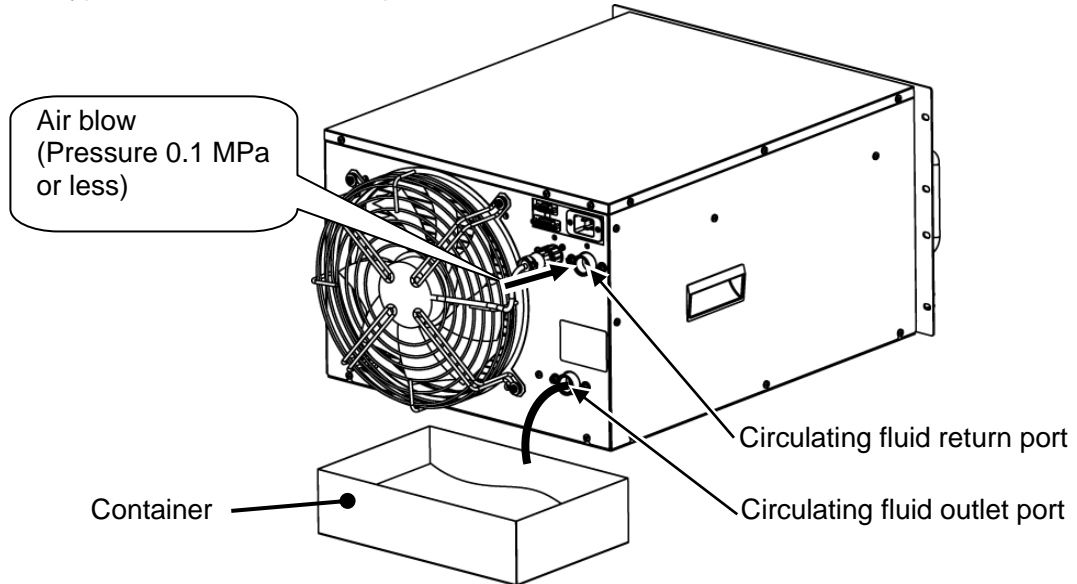
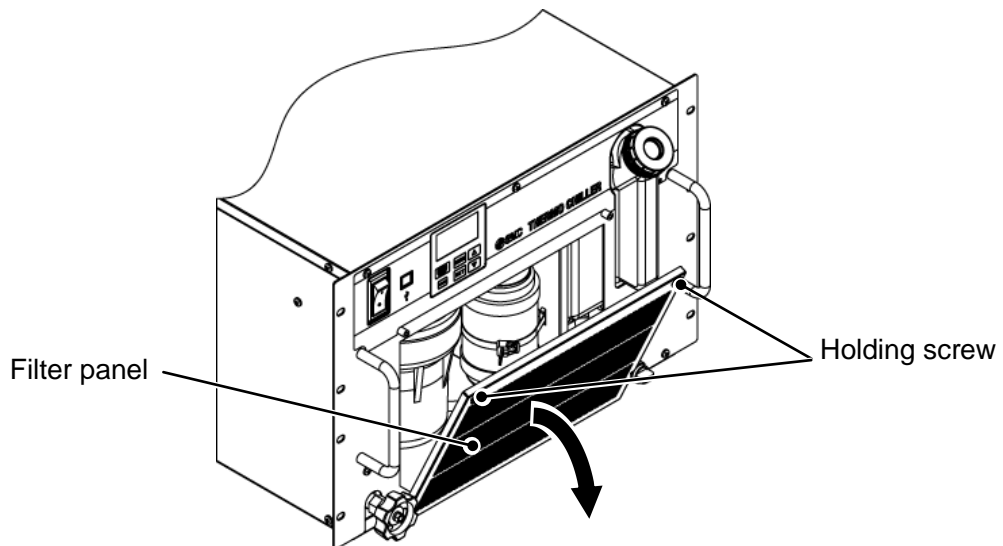

Fig. 8-5 Discharge of the circulating fluid

- 3.** Blow out circulating fluid inside of piping of this product by air blow. Blow air (pressure: 0.1 MPa or less, about one minute) from circulating fluid return port. The fluid will come out from drain port and circulating fluid outlet. When executing this operation, tank cap should be closed and bypass valve should be opened.



- 4.** Particle filter is installed inside of this product. Discharge circulating fluid from inside of filter case. Remove filter panel holding screws by using cross slot screw driver and remove the filter panel.



- 5.** Remove the filter case by using maintenance handle which is supplied with product. Please note that circulating fluid may flow out from the case when removing filter case. Discharge circulating fluid inside of filter case. Do not drop out filter element from inside of filter case during this operation. After discharging circulating fluid, mount the resin filter case by hand tighten.

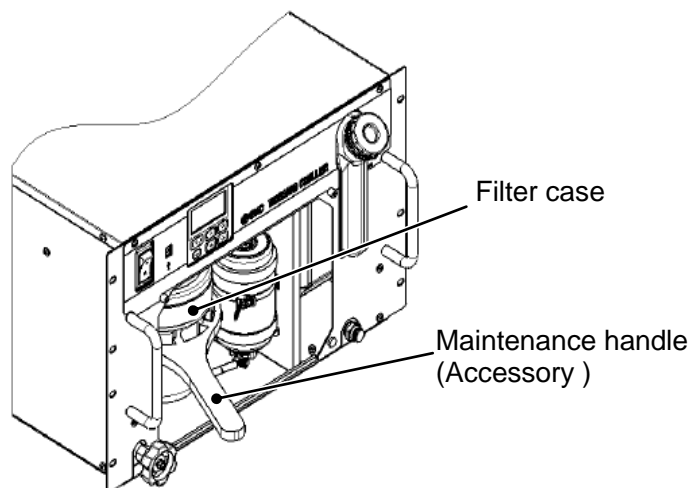

Insert the element into the resin filter case. Mount the resin filter case by hand tighten.

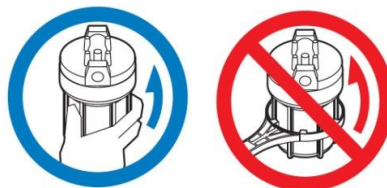

⚠ Caution

- Mounting of the case should be performed by hand-tighten. When the case is tightened excessively by tools or handle, the case might crack or be damaged.
- Make sure that the case is held manually by hand when removing and mounting the case. If the case is dropped, it may result in cracking or breakage.

- 6.** Use a cross slot screwdriver to install the filter panel.
(Recommended tightening torque : 1.5N · m)

8.3.2 Discharge of the facility water (Water-cooled type)

⚠ WARNING



- Before discharging the facility water, stop operation of the user's equipment and release the residual pressure.
- Wear protective equipments like gloves to avoid getting injure like a cutting hand by sharp edge of panel

- 1.** Shut off the user's power supply (breaker) .Turn off the power switch of this product.
- 2.** Stop supplying the facility water, and make sure that there is no pressure applied inside the piping.
- 3.** Remove the piping from facility water inlet/outlet port.
- 4.** Remove the cover panel on the back of the product using a cross slot screwdriver.
(4 fixing screws)

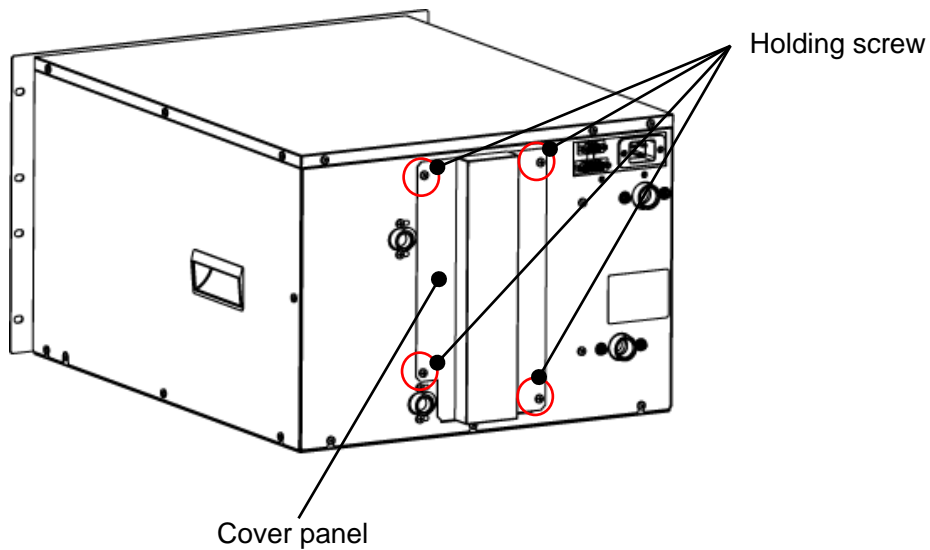

Fig. 8-6 Discharge of the facility water

-
- 5.** Loosen air releasing plug. Facility water will come out from facility water inlet port.

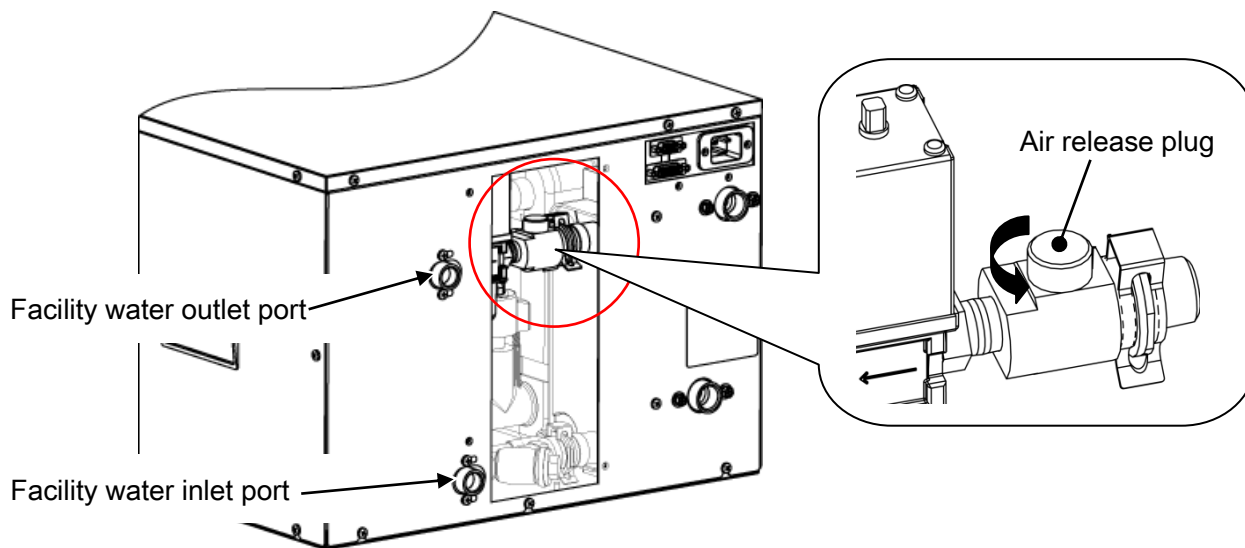

Fig. 8-7 Discharge of the facility water

-
- 6.** After draining the facility water, securely tighten the air release plug.

-
- 7.** Install the cover panel by reverse procedure. (Recommended tightening torque: $1.5\text{N}\cdot\text{m}$)

8.4 Replacement of consumables

8.4.1 Replacing Particle Filters

To replacing the element of the particle filter, it is necessary to discharge the circulating fluid. Refer to "8.3.1. Discharge of the facility water " and remove the filter case and replace the element.

Replacement element part number	EJ202S-005X11
---------------------------------	---------------

8.4.2 Replacing the DI filter (Option DM)

When option DM(Electric conductivity control function , DI water (pure water) piping) is selected, a DI filter is installed inside this product. When replacing the DI filter, it is necessary to discharge the circulating fluid. Wear protective equipments like gloves to avoid getting injure like a cutting hand by sharp edge of panel.

1. Drain the circulating fluid. Refer to ""8.3.1. Discharge of the circulating fluid " and discharge circulating fluid.

2. Remove DI filter fixing band by pushing lever on the band.

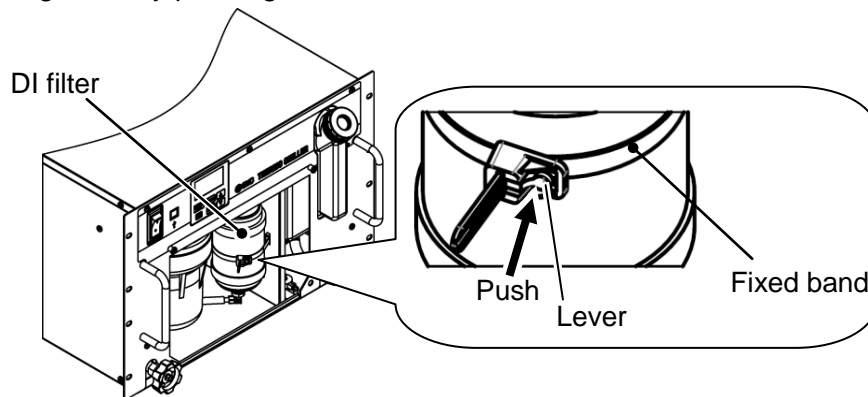

3. Pull out DI filter from opening of front side.

Tubes are connected to DI filter. Be care do not tension this tube when pulling out DI filter.

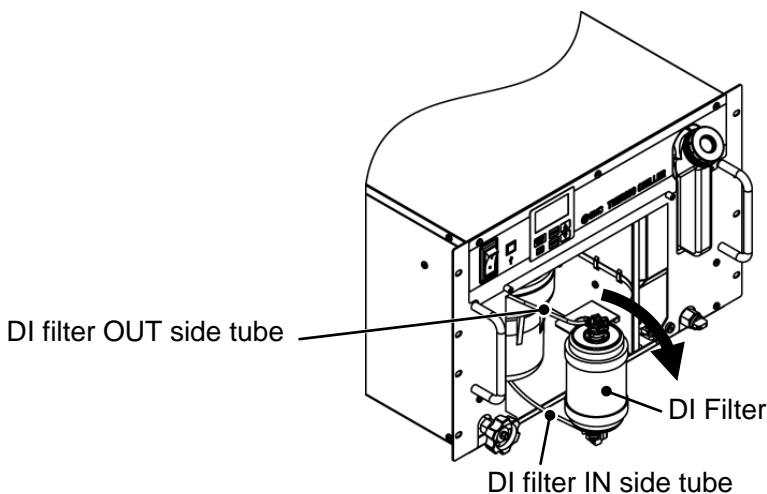

- 4.** The connection fitting of the DI filter and the tube is connected by a fastener. O ring is used for the connection fitting. After removing the fastener, remove the connection fitting. Be careful not to apply force to the tube at this time. Also, please be careful not to damage the O ring.

Both the IN side and the OUT side have the same shape. Remove the connection fitting on both sides and remove the DI filter.

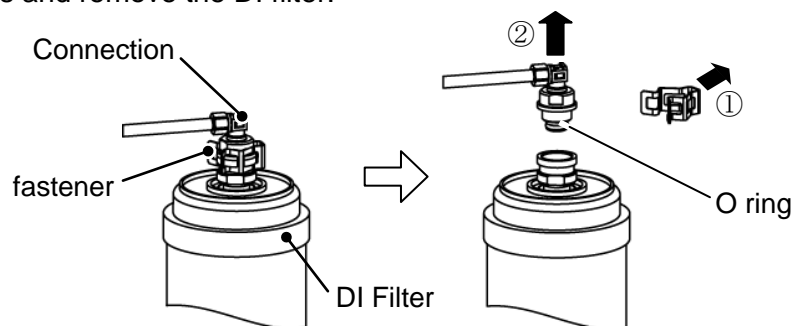

- 5.** Install the DI filter in the reverse procedure that you removed.
There is no flow direction in the DI filter.
Connect the DI filter IN side tube to the bottom of the DI filter and the DI filter OUT side tube to the upper side. Conversely, if the connection is made, the air in the DI filter will not come out and the function of the DI filter may not work properly.

- 6.** Fix DI filter with DI filter fixing band.

- 7.** Install the filter panel. (Recommended tightening torque: 1.5N·m)

8.5 Electrical schematic diagram

“Air-cooled type”

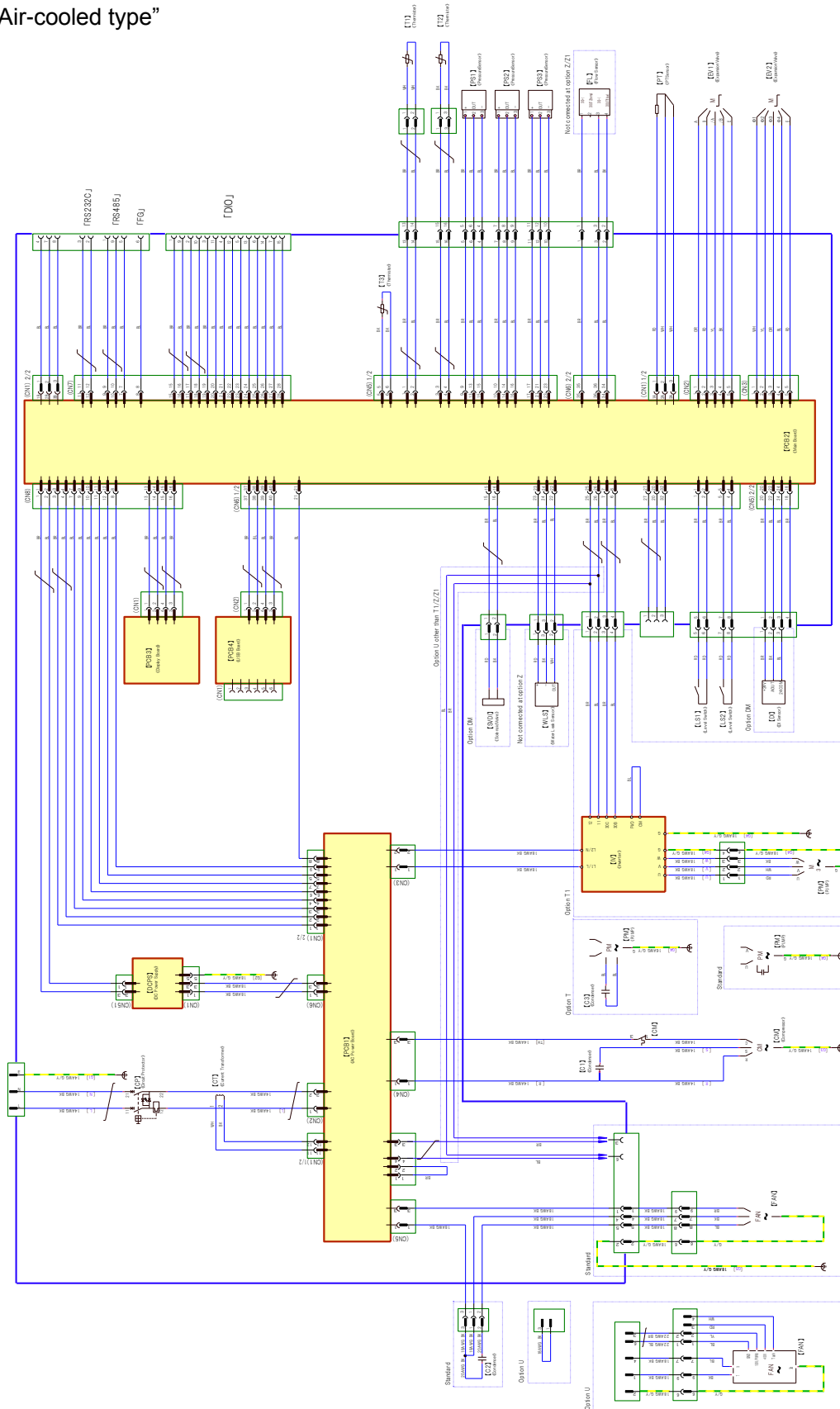

Fig. 8-8 Electrical schematic diagram (Air-cooled type)

“Water-cooled type”

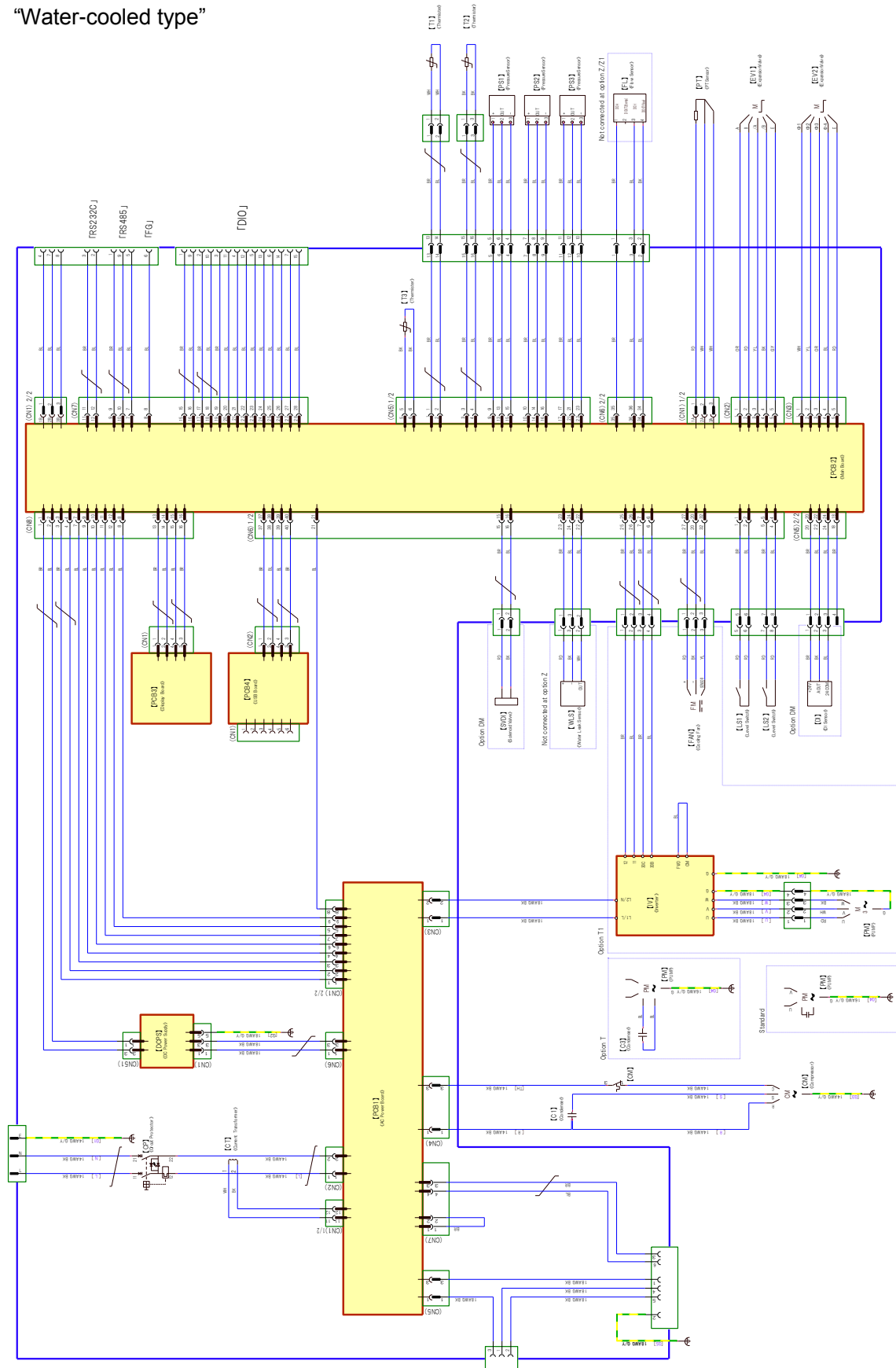

Fig. 8-9 Electrical schematic diagram (Water-cooled type)

Chapter 9 Documents

9.1 Specifications

9.1.1 HRR012/018/024/030-A-10/20-*

Table 9-1 Specifications [HRR012/018/024/030-A-10/20-*

Model		HRR012-A-10-*	HRR018-A-10-*	HRR012-A-20-*	HRR018-A-20-*	HRR024-A-20-*	HRR030-A-20-*	
Cooling method		Air-Cooled refrigerated type						
Refrigerant		R410A(HFC)						
Quantity of refrigerant	Kg	0.36	0.36	0.38	0.38	0.47	0.47	
Control method		PID control						
Ambient temperature and humidity and altitude * ¹		Temperature:5 to 40°C, Humidity:30 to 70%, Altitude: Less than 3000m						
Circulating fluid system	Circulating fluid* ²	Tap water, Ethylene glycol aqueous solution 15%						
	Operating temperature range* ¹	°C	5 to 35* ²⁰					
	Cooling capacity(50/60Hz) * ³	W	1000/1200	1600/1800	1000/1200	1600/1800	2000/2400	2500/3000
	Heating capacity(50/60Hz) * ⁴	W	400/500		450/500		550/700	
	Temperature stability * ⁵	°C	±0.1					
	Pump capacity (50/60Hz) * ⁶	MPa	0.13(at 7L/min)/0.18(at 7L/min) For option -T,MT:0.36(at 7L/min)/0.42(at 10L/min)		0.13(at 7L/min)/0.18(at 7L/min) For option -T : 0.42(at 10L/min)/0.4(at 14L/min) For option -MT : 0.32(at 10L/min)/0.32(at 14L/min) For option -T1 : 0.28(at 10L/min)/0.28(at 10L/min)			
	Rated flow rate (50/60Hz) * ⁷	L/min	7 / 7 For option -T , -MT : 7/10		7 / 7 For option -T , -MT : 10/14 For option-T1 : 10 / 10			
	Flow display range	L/min	2 to 16					
	Electric conductivity display range	µS/cm	0.1 to 48(For option -DM)					
	Electric conductivity setting range	µS/cm	0.5 to 45(For option -DM) * ²¹					
	Particle filter nominal filtration rating	µm	5					
	Bypass valve		Installed					
	Tank capacity	L	Approx. 4					
	Fluid outlet, fluid return port size		Rc1/2					
	Drain port size		Rc1/4, With cap					
	Leakage protection		Drain pan (With water leakage detector)					
Fluid contact part material		Stainless steel, Copper brazing (Heat exchanger) * ¹² , Brass * ¹⁷ , Bronze * ¹⁷ , SiC, Aluminum oxide ceramic, Carbon, PP, PE, POM, PA, FKM, EPDM, PVC, PPS, AS, fluoropolymer * ¹³ , Ion exchange resin * ¹³						
Electrical system	Power supply	1-phase AC100V (50/60Hz) 1-phase AC115V (60Hz) Allowable voltage fluctuation±10% * ¹⁵		1-phase AC200 to 230V 50/60Hz Allowable voltage fluctuation±10% * ¹⁵				
	Circuit protector	A	15		10 (For option -T,-MT,-T1 : 15)			
	Applicable earth leakage breaker * ⁸	Rated current: 15A Sensitivity current: 30mA		Rated current: 10A (For option -T,-MT,-T1 : 15A) Sensitivity current: 30mA				
	Cable Qty x size (Including ground) * ¹⁶	3 cores x14AWG(3 coresx2.0m m)						
	Rated operating current (50/60Hz) * ³	A	8.9/8.9	9.1/9.6	3.6/4.0	3.6/4.3	5.2/5.8	5.5/6.2
			For option -T,-MT					
			10.7/10.7	11.0/11.0	4.7/6.2	4.7/6.5	6.3/8.0	6.5/8.3
	Rated power consumption (50/60Hz) * ¹⁸	kW (kVA)	0.8/0.9 (1.0/1.0)	0.9/1.1 (1.1/1.1)	0.6/0.8 (0.7/0.8)	0.7/0.9 (0.7/0.9)	0.9/1.2 (1.1/1.2)	1.0/1.2 (1.1/1.3)
			For option -T,-MT					
			0.9/1.1 (1.1/1.1)	1.0/1.3 (1.2/1.3)	0.9/1.2 (0.9/1.2)	0.9/1.3 (1.0/1.3)	1.2/1.6 (1.3/1.6)	1.3/1.6 (1.3/1.7)
		For option -T1						
		0.9/1.0 (1.0/1.2)	0.9/1.0 (1.1/1.2)	1.2/1.2 (1.3/1.4)	1.2/1.3 (1.3/1.5)			
Communication function		Contact input / output, Serial RS-485 / RS-232C						
Noise level (50/60Hz) * ⁹	dB(A)	59/60	59/60	59/60	59/60	61/64	61/64	
Dimensions * ¹⁰	mm	W483xD550xH310				W483xD550xH399		
Accessory * ¹⁹	power supply connector, Maintenance handle for particle filter * ¹⁹ , Operation manual, Particle filter element * ¹⁹							
Weight * ¹¹	kg	41		40		46		

- *1: Use the product in conditions where freezing will not occur. Consult with SMC if using in a season or region where the ambient temperature will fall below zero.
- *2: If tap water is used, use water which satisfies the standard of The Japan Refrigeration And Air Conditioning Industry Association (JRA GL-02-1994/Cooling water system –circulation type - make-up water).
- *3: (1)Ambient temp: 25°C, (2)Circulating fluid temp.: 20°C, (3)Circulating fluid rated flow, (4)Circulating fluid : Tap water,(5)Power supply :100V type:AC100V, 200V type AC200V, (6)Piping length : Shortest The cooling capacity will be reduced by about 300W when option T, MT [High pressure pump mounted] and option T1 [Inverter pump mounted] are selected.
- *4: (1)Ambient temp: 25°C, (2)Circulating fluid temp:20°C,(3) Circulating fluid rated flow, (4)Circulating fluid : Tap water, (5)Power supply : 100V type:AC100V, 200V type AC200V, (6)Piping length : Shortest
- *5: Outlet temp. when the circulating fluid flow is rated flow, and the circulating fluid outlet and the return are directly Connected. Installation environment and power supply are within specification range and stable.
- *6: The capacity at the thermo-chiller outlet when the circulating fluid temp. is 20°C.
- *7: Fluid flow to maintain the cooling capacity and the temperature stability.The specification of the cooling capacity and the temperature stability may not be satisfied if the flow rate is lower than the rated flow.
- *8: To be prepared by the customer. Use an earth 30mA/100V type :AC100V, 200V type : 200V in power supply specification.
- *9: Front 1m/Height 1m/Static with no load. See note 4 for other conditions.
- *10: Dimension between panels. Projection is not included.
When option Y[With feet, and no Rack Mounting bracket] is selected, refer to [6.5. Option Y[With feet and no Rack Mounting bracket]].
- *11: Weight when the circulating fluid is not included. The weight will increase by 1kg when option DM [Electric conductivity control +Applicable to deionized water piping], is selected. The weight will increase by 5kg when option T [High pressure pump mounted] and MT [Applicable to deionized water piping + High pressure pump mounted] are selected. The weight will decrease by 1kg when option T1, option Z1.
- *12: Copper and brass are not included when option M [Applicable to deionized water piping] and MT [Applicable to deionized water piping + High pressure pump] is selected.
- *13: When option DM [Electric conductivity control + Applicable to deionized water piping] is selected, these materials are included.
- *14: If the altitude is 1000 m or more, please refer to "P.3-3 When Thermo-chiller installation in high altitude of 1000 meters or more".
- *15: No continuous voltage fluctuation.
- *16: To be prepared by the customer.
- *17: When option T [High pressure pump] is selected, these material are included.
- *18: (1)Ambient temp: 25°C, (2)Circulating fluid temp: 20°C, (3) Circulating fluid rated flow, (4) Circulating fluid: Tap water, (5)Power supply: 100V type:AC100V, 200V type AC200V, (6)Piping length: Shortest, (7)Rated cooling load is applied.
- *19: When Option DM[Electric conductivity control + Applicable to deionized water piping] is selected, DI filter will be added.
Piping thread type : When F is selected, G thread adapter set will be added.
Piping thread type : When N is selected, NPT thread adapter set will be added.
Not included for options Z and Z1.
- *20: 200V type manufactured before August 2019 (Serial:XV***) can not be set below 10°C.
- *21: 200V type manufactured before August 2019 (Serial:XV***) can not be set below 5µS/cm.

9.1.2 HRR012/018/024/030-W-10/20-*

Table 9-2 Specifications [HRR012/018/024/030-W-10/20-*

Model		HRR012-W-10-*	HRR018-W-10-*	HRR012-W-20-*	HRR018-W-20-*	HRR024-W-20-*	HRR030-W-20-*	
Cooling method		Water-Cooled refrigerated type						
Refrigerant		R410A(HFC)						
Quantity of refrigerant	Kg	0.25	0.25	0.25	0.25	0.4	0.4	
Control method		PID control						
Ambient temperature and humidity and altitude ^{*1 *15}		Temperature: 5 to 40°C, Humidity: 30 to 70%, Altitude: Less than 3000m						
Circulating fluid system	Tap water, Ethylene glycol aqueous solution 15%	Tap water, Ethylene glycol aqueous solution 15%						
	Operating temperature range ^{*1}	°C	5 to 35 ^{*21}					
	Cooling capacity (50/60Hz) ^{*3}	W	1000/1200	1600/1800	1000/1200	1600/1800	2000/2400	2500/3000
	Heating capacity (50/60Hz) ^{*4}	W	400/500		450/500		550/700	
	Temperature stability ^{*5}	°C	±0.1					
	Pump capacity (50/60Hz) ^{*6}	MPa	0.13(at 7L/min)/0.18(at 7L/min) For option -T/MT: 0.36(at 7L/min)/0.42(at 10L/min)		0.13(at 7L/min)/0.18(at 7L/min) For option -T : 0.42(at 10L/min)/0.4(at 14L/min) For option -MT : 0.32(at 10L/min)/0.32(at 14L/min) For option -T1 : 0.28(at 10L/min)/0.28(at 10L/min)			
	Rated flow (50/60Hz) ^{*7}	L/min	7 / 7 For option -T, -MT: 7/10		7 / 7 For option -T, -MT : 10/14 For option -T1 : 10/10			
	Flow display range	L/min	2 to 16					
	Electric conductivity display range	µS/cm	0.1 to 48(For option -DM)					
	Electric conductivity setting range	µS/cm	0.5 to 45(For option -DM) ^{*22}					
	Particle filter nominal filtration rating	µm	5					
	Bypass valve		Installed					
	Tank capacity	L	Approx. 4					
	Fluid outlet, fluid return port	port size	Rc1/2					
	Drain port size		Rc1/4, With cap					
	Leakage protection		Drain pan structure (With water leakage detector)					
Fluid contact part material		Stainless steel, Copper brazing (Heat exchanger) ^{*12} , Brass ^{*18} , Bronze ^{*18} , SiC, Aluminum oxide ceramic, Carbon, PP, PE, POM, PA, FKM, EPDM, PVC, PPS, AS, fluoropolymer ^{*13} , Ion exchange resin ^{*13}						
Facility water outlet system	Temperature range	°C	5 to 40					
	Pressure range	MPa	0.3 to 0.5					
	Required flow ^{*14}	L/min	8	12	8	12	14	15
	Facility water pressure difference	MPa	0.3 more					
	Port size		Rc3/8					
	Fluid contact material		Stainless steel, Copper brazing, Bronze, Synthetic rubber					
Electrical system	Power supply		1-phase AC100V (50/60Hz) 1-phase AC115V (60Hz) Allowable voltage fluctuation ±10% ^{*15}		1-phase AC200 to 230V 50/60Hz Allowable voltage range 10% ^{*16}			
	Circuit protector	A	15		10 (For option -T, -MT, -T1: 15)			
	Applicable earth leakage breaker ^{*8}		Rated current: 15A Sensitivity current: 30mA		Rated current: 10A (For option -T, -MT, -T1: 15A) Sensitivity current: 30mA			
	Cable Qty x size (Including ground) ^{*16}		3 core x 14AWG (3 core x 2.0mm ²)					
	Rated operating current (50/60Hz) ^{*3}	A	8.5/8.5	8.7/8.7	3.2/3.6	3.3/3.6	4.9/5.1	4.9/5.2
			For option -T, -MT					
	Rated power consumption (50/60Hz) ^{*19}	kW (kVA)	10.5/10.5	10.8/10.8	4.3/5.8	4.4/5.8	6.0/7.3	6.0/7.4
			For option -T1					
			0.7/0.8 (0.9/0.9)	0.8/0.9 (1.0/1.0)	0.6/0.7 (0.7/0.7)	0.6/0.7 (0.7/0.7)	5.9/6.0 (1.0/1.0)	5.9/6.1 (1.0/1.0)
			For option -T, -MT					
Rated power consumption (50/60Hz) ^{*19}	kW (kVA)	0.9/1.0 (1.1/1.0)	1.0/1.1 (1.2/1.1)	0.9/1.1 (0.9/1.2)	0.9/1.1 (0.9/1.2)	1.1/1.2 (1.4/1.4)	1.1/1.2 (1.4/1.4)	
		For option -T1						
Rated power consumption (50/60Hz) ^{*19}	kW (kVA)	0.9/1.0 (1.0/1.1)	1.0/1.1 (1.2/1.1)	0.9/1.0 (1.0/1.1)	0.9/1.0 (1.0/1.1)	1.0/1.1 (1.2/1.2)	1.0/1.1 (1.2/1.2)	
		For option -T1						
Communication function		Contact input / output, Serial RS-485 / RS-232C						
Noise level (50/60Hz) ^{*9}	dB(A)	59/60	59/60	59/60	59/60	61/64	61/64	
Dimensions ^{*10}	mm	W483xD550xH310				W483xD550xH399		
Accessory ^{*20}		Power supply connector, Maintenance handle for particle filter ^{*20} , Operation manual, Particle filter element ^{*20}						
Weight ^{*11}	kg	40		41		45		

- *1: Use the product in conditions where freezing will not occur. Consult with SMC if using in a season or region where the ambient temperature will fall below zero.
- *2: If tap water is used, use water which satisfies the standard of The Japan Refrigeration And Air Conditioning Industry Association (JRA GL-02-1994/Cooling water system –circulation type - make-up water).
- *3: (1)Facility water temp: 25°C, (2)Circulating fluid temp: 20°C, (3) Circulating fluid rated flow,(4) Circulating fluid : Tap water, (5)Power supply : 100V type:AC100V, 200V type AC200V,(6)Piping length : Shortest
The cooling capacity will be reduced by 300W when option T and MT [High pressure pump] and option T1 [Inverter pump mounted] are selected. Depending on the conditions, it may decrease by 300W or more.
- *4: (1)Ambient temp.: 25°C, (2)Facility water temp: 25°C, (3)Circulating fluid temp.: 20°C, (4)Circulating fluid rated flow, (5)Circulating fluid : Tap water,(6)Power supply : 100V type:AC100V, 200V type AC200V, (7)Piping length : Shortest
- *5: Outlet temp. when the circulating fluid flow is rated flow, and the circulating fluid outlet and the return are directly connected. Installation environment and power supply are within specification range and stable.
- *6: The capacity at the thermo-chiller outlet when the circulating fluid temp. is 20°C.
- *7: Fluid flow to maintain the cooling capacity and the temperature stability.
The specification of the cooling capacity and the temperature stability may not be satisfied if the flow rate is lower than the rated flow.
- *8: To be prepared by the customer. Use an earth 30mA/100V type :AC100V, 200V type : 200V in power supply specification.
- *9: Front 1m/Height 1m/Static with no load. See note 4 for other conditions.
- *10: Dimension between panels. Projection is not included.
When option Y[With feet, and no Rack Mounting bracket] is selected, refer to [6.5. Option Y[With feet and no Rack Mounting bracket]].
- *11: Weight when the circulating fluid is not included. The weight will increase by 1kg when option DM [Electric conductivity control + Applicable to deionized water piping] is selected. The weight will increase by 5kg when option T [High pressure pump] and MT [Applicable to deionized water piping + High pressure pump]are selected. The weight will decrease by 1kg when option T1.The weight will decrease by 1kg when option Z.
- *12: Copper and brass are not included when option M [Applicable to deionized water piping] and MT [Applicable to deionized water piping + High pressure pump] is selected.
- *13: When option DM [Electric conductivity control + Applicable to deionized water piping] is selected, these materials are included.
- *14: Required flow rate when a load for the cooling capacity is applied at a condition of note 3.
- *15: If the altitude is 1000 m or more, please refer to "P.3-3 When Thermo-chiller installation in high altitude of 1000 meters or more".
- *16: No continuous voltage fluctuation.
- *17: To be prepared by the customer.
- *18: When option T [High pressure pump] is selected, these materials are included.
- *19: (1)Ambient temp: 25°C, (2)Circulating fluid temp: 20°C, (3) Circulating fluid rated flow, (4) Circulating fluid : Tap water, (5)Power supply: 100V type:AC100V, 200V type AC200V, (6)Piping length: Shortest, (7)Rated cooling load is applied.
- *20: When Option DM[Electric conductivity control + Applicable to deionized water piping] is selected, DI filter will be added.
Piping thread type : When F is selected, G thread adapter set will be added.
Piping thread type : When N is selected, NPT thread adapter set will be added.
Not included for options Z and Z1.
- *21: 200V type manufactured before August 2019 (Serial:XV***) can not be set below 10°C.
- *22: 200V type manufactured before August 2019 (Serial:XV***) can not be set below 5µS/cm.

9.1.3 Refrigerant with GWP reference

Table 9-3 Refrigerant with GWP reference

Refrigerant	Global Warming Potential (GWP)	
	Regulation (EU) No 517/2014 (Based on the IPCC AR4)	Revised Fluorocarbons Recovery and Destruction Law (Japanese law)
R134a	1,430	1,430
R404A	3,922	3,920
R407C	1,774	1,770
R410A	2,088	2,090

Note:

1. This product is hermetically sealed and contains fluorinated greenhouse gases.
2. See specification table for refrigerant used in the product.

9.1.4 Communication specification

- For communication specification, refer to Operation Manual Communication Function

9.2 Outline dimensions

9.2.1 HRR012/018-A-10/20-*

For Option Y(With feet and no Rack Mounting bracket), refer to [6.5 Option Y(With feet and no Rack Mounting bracket)].

Model	A	B
HRR012/018-A-10-*	45	70
HRR012/018-A-20-*	61	80
HRR012/018-A-20-U	50	80

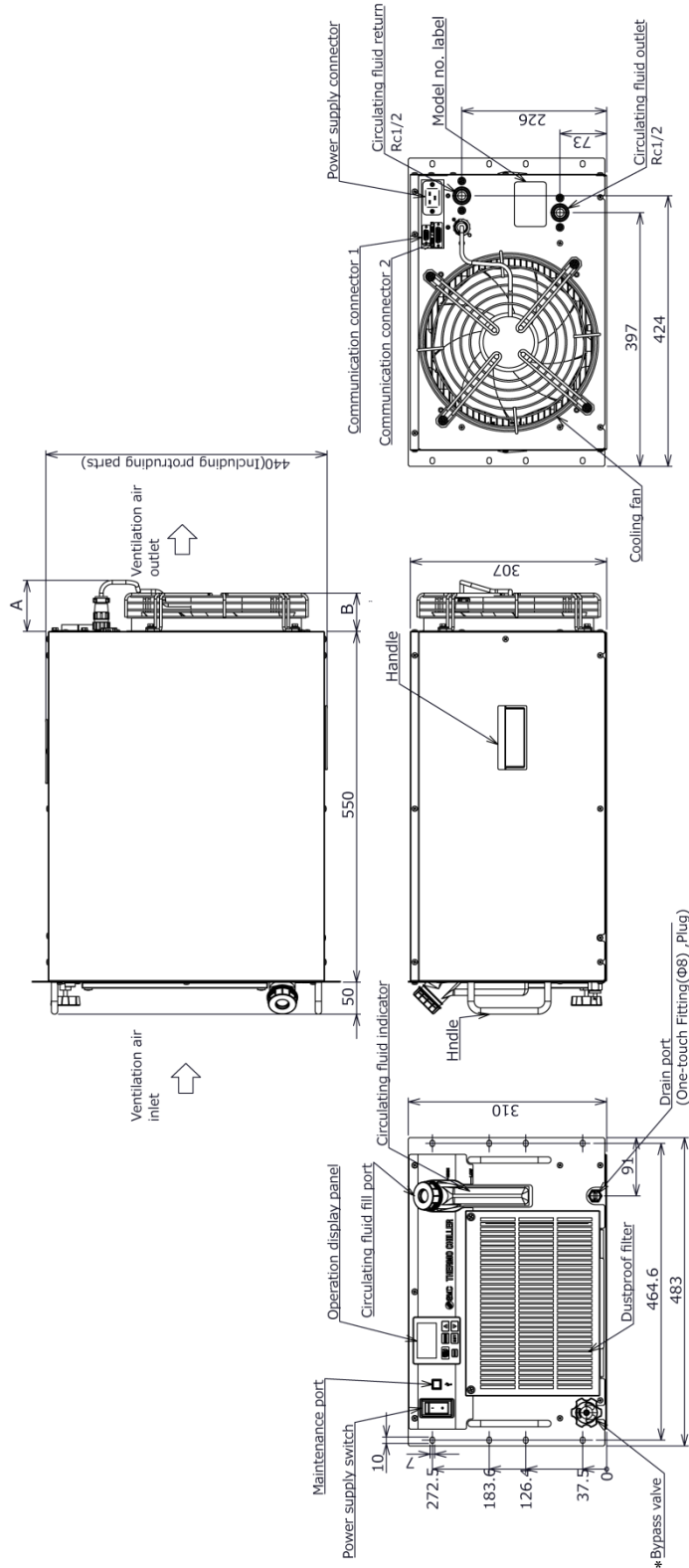

Fig. 9-1 Outline dimensions (HRR012/018-A-10/20-*)

*In the case of option Z, without bypass valve

9.2.2 HRR012/018-W-10/20-*

For Option Y (With feet and no Rack Mounting bracket), refer to [6.5 Option Y (With feet and no Rack Mounting bracket)].

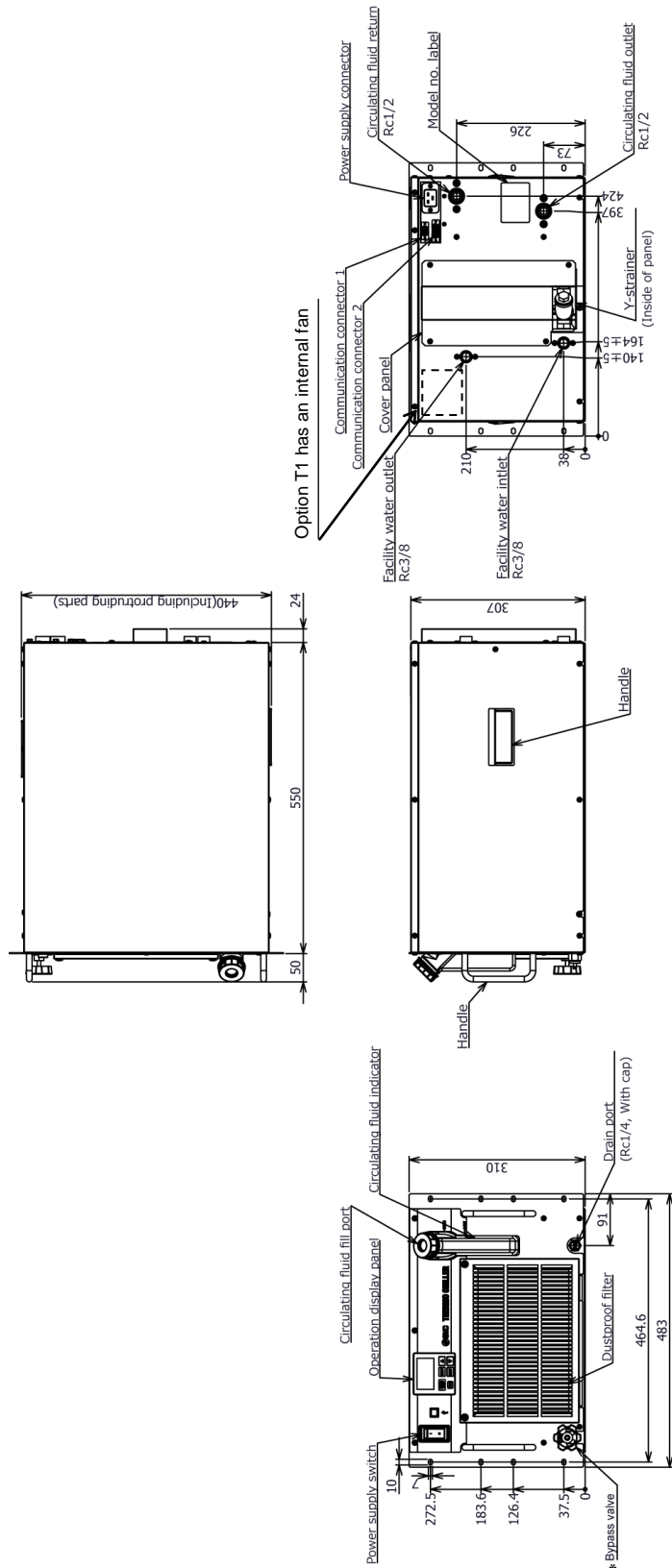
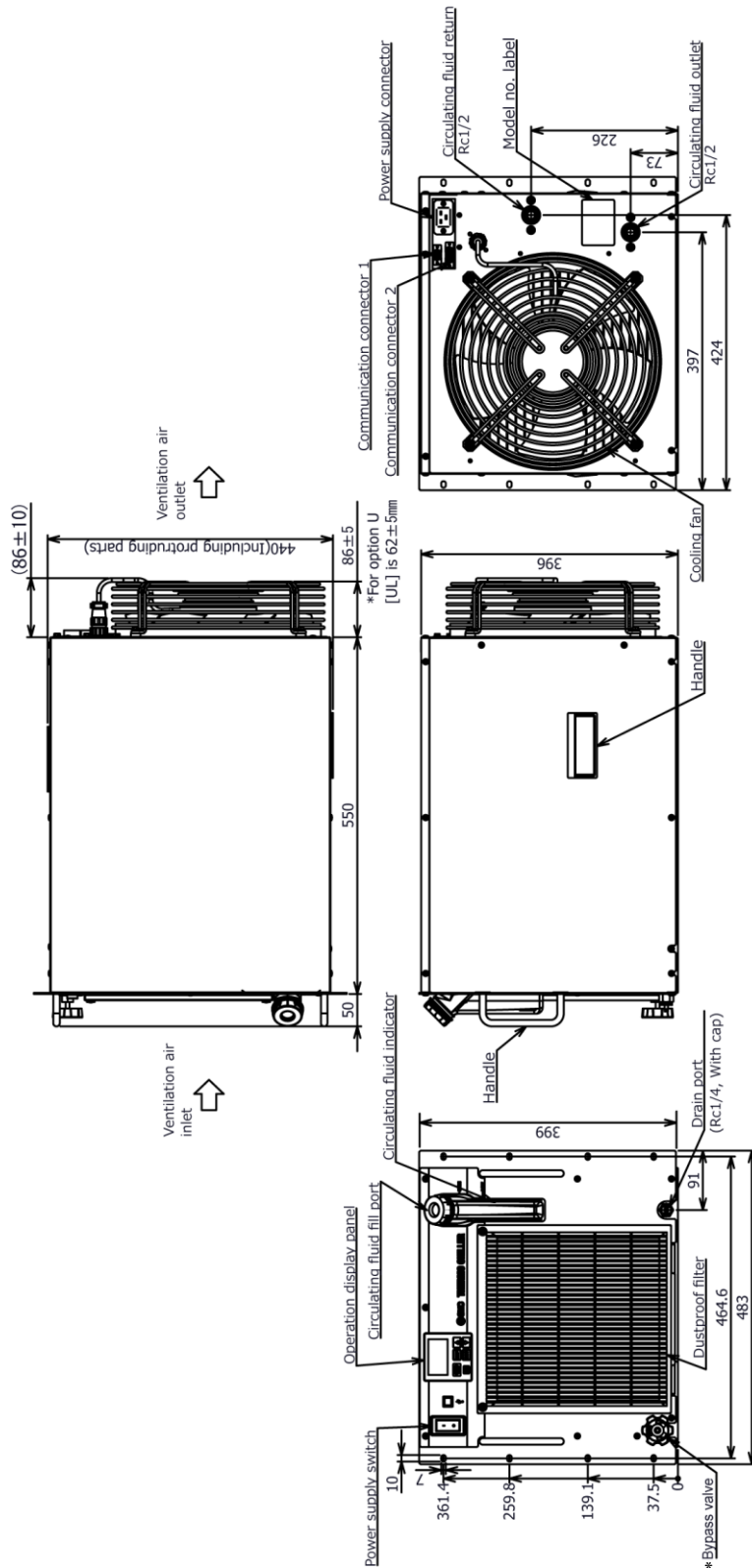

Fig. 9-2 Outline dimensions (HRR012/018-W-10/20-*)

*In the case of option Z, without bypass valve

9.2.3 HRR024/030-A-20-*

For Option Y (With feet and no Rack Mounting bracket), refer to [6.5 Option Y (With feet and no Rack Mounting bracket)].



*In the case of option Z, without bypass valve

Fig. 9-3 Outline dimensions (HRR024/030-A-20-*)

9.2.4 HRR024/030-W-20-*

For Option Y (With feet and no Rack Mounting bracket), refer to [6.5 Option Y (With feet and no Rack Mounting bracket)].

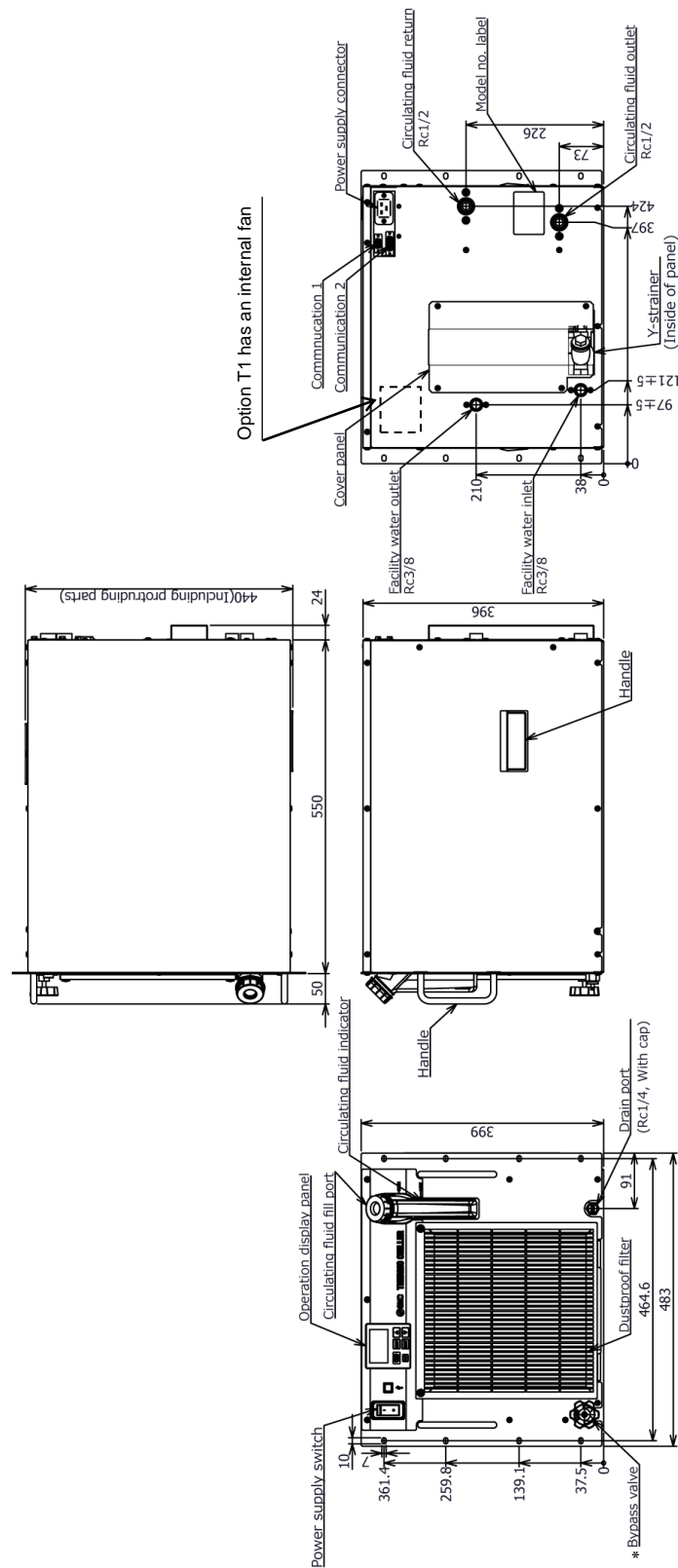

*In the case of option Z, without bypass valve

Fig. 9-4 Outline dimensions (HRR024/030-W-20-*)

9.3 Flow Chart

9.3.1 HRR012/018/024/030-A-10/20-*

- ← - - - Circulating fluid circuit
 - ← - Refrigerant circuit
 - ← - - - Electric conductivity circuit
 (For option -DM [Electric conductivity control])
- *1 Excluded for options Z and Z1.
 *2 Excluded for option Z.

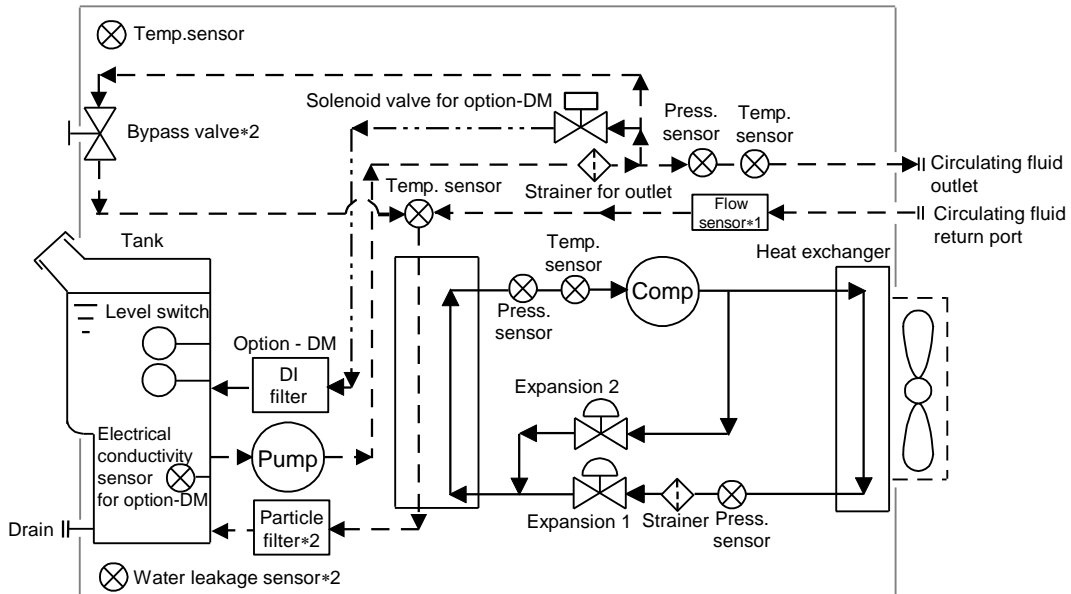

Fig. 9-5 Flow Chart(HRR012/018/024/030-A-10/20-*)

9.3.2 HRR012/018/024/030-W-10/20-*

- ← - - - Circulating fluid circuit
 - ← - Refrigerant circuit
 - ← - - - Facility water circuit
 - ← - - - Electric conductivity circuit
 (For option -DM [Electric conductivity control])
- *1 Excluded for options Z and Z1.
 *2 Excluded for option Z.

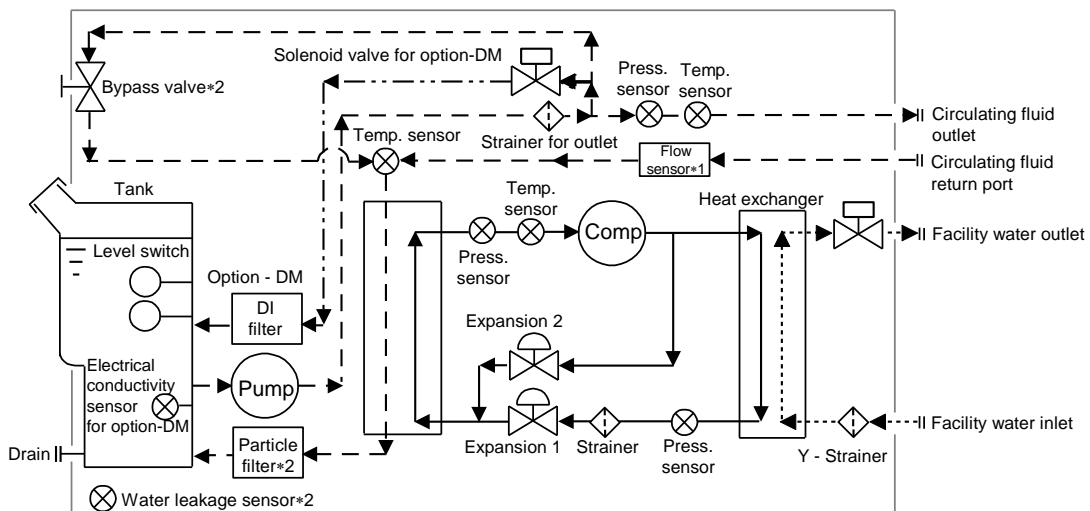
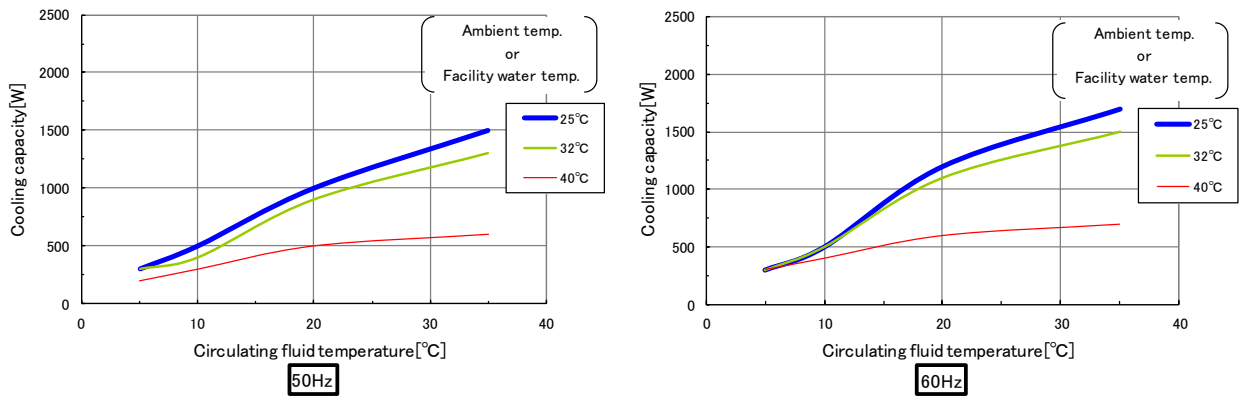

Fig. 9-6 Flow Chart (HRR012/018/024/030-W-10/20-*)

9.4 Cooling capacity

9.4.1 HRR012-A/W-10/20-*



*The cooling capacity will be reduced by about 300W when option: -T, -MT, -T1 are selected.

Fig 9-7 Cooling capacity (HRR012-A/W-10/20-*)

9.4.2 HRR018-A/W-10/20-*

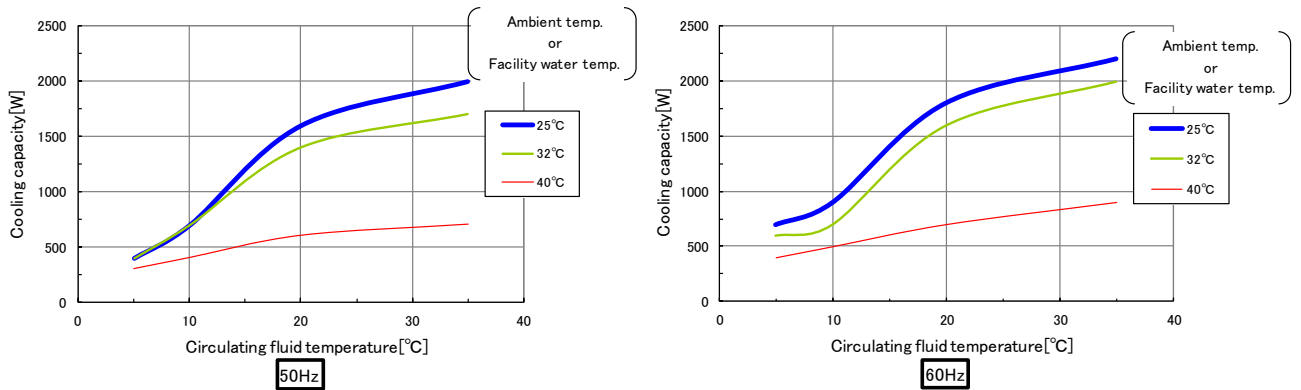

*The cooling capacity will be reduced by about 300W when option: -T, -MT, -T1 are selected.

Fig 9-8 Cooling capacity (HRR018-A/W-10/20-*)

9.4.3 HRR024-A/W-20-*

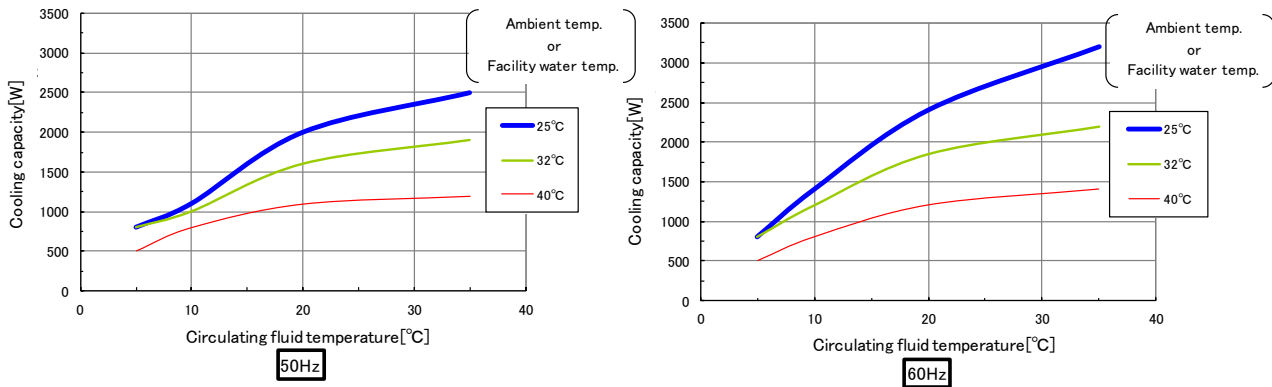

*The cooling capacity will be reduced by about 300W when option: -T, -MT, -T1 are selected.

Fig 9-9 Cooling capacity (HRR024-A/W-20-*)

9.4.4 HRR030-A/W-20-*

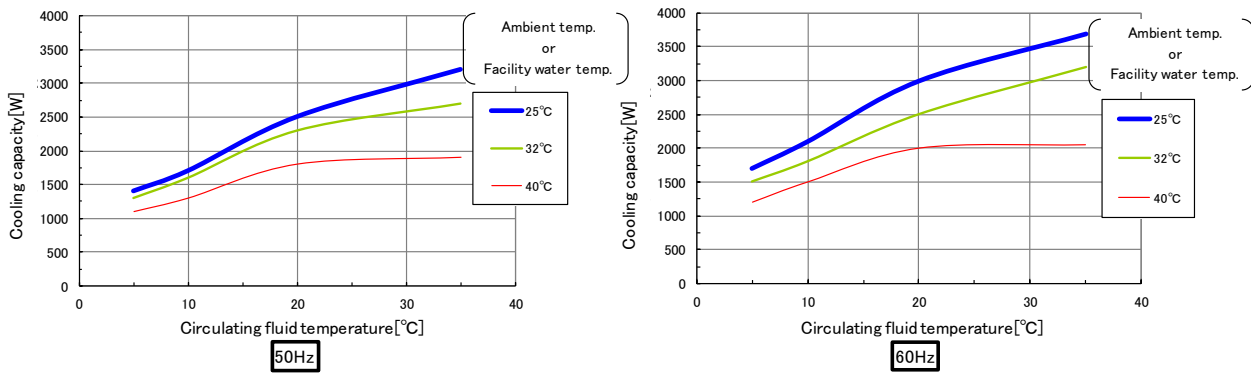

*The cooling capacity will be reduced by about 300W when option: -T, -MT, -T1 are selected.

Fig 9-10 Cooling capacity (HRR030-A/W-20-*)

9.5 Heating capacity

9.5.1 HRR012-A/W-10-*,HRR018-A/W-10-*

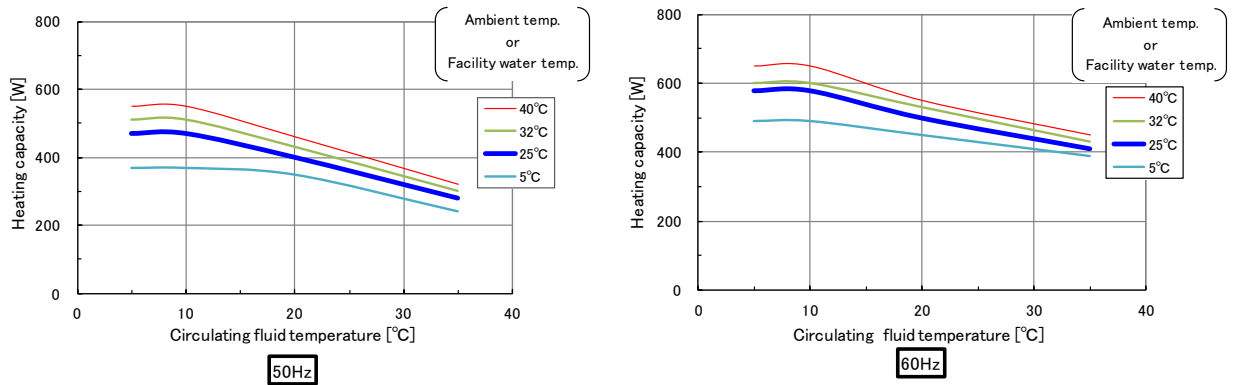

Fig 9-11 Heating capacity (HRR012-A/W-10,HRR018-A/W-10)

9.5.2 HRR012-A/W-20,HRR018-A/W-20

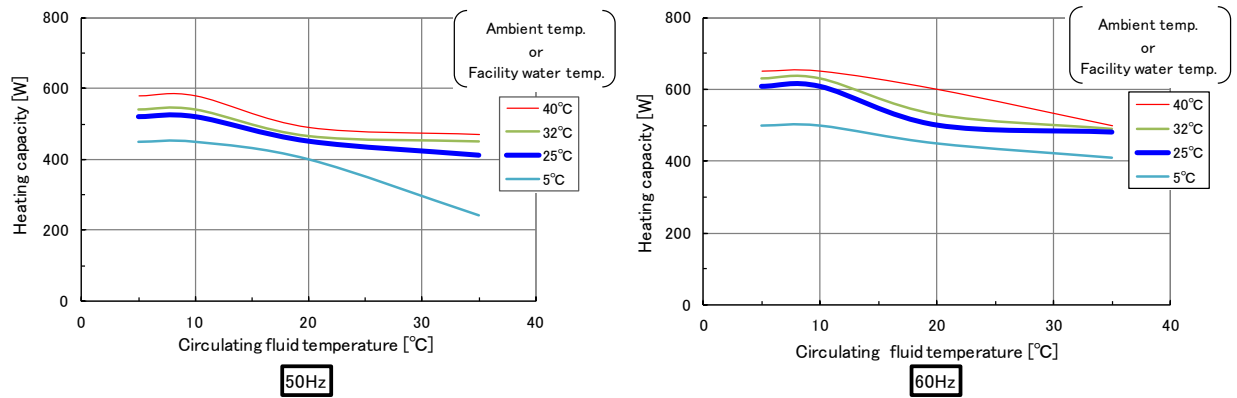

Fig 9-12 Heating capacity (HRR012-A/W-20,HRR018-A/W-20)

9.5.3 HRR024-A/W-20,HRR030-A/W-20

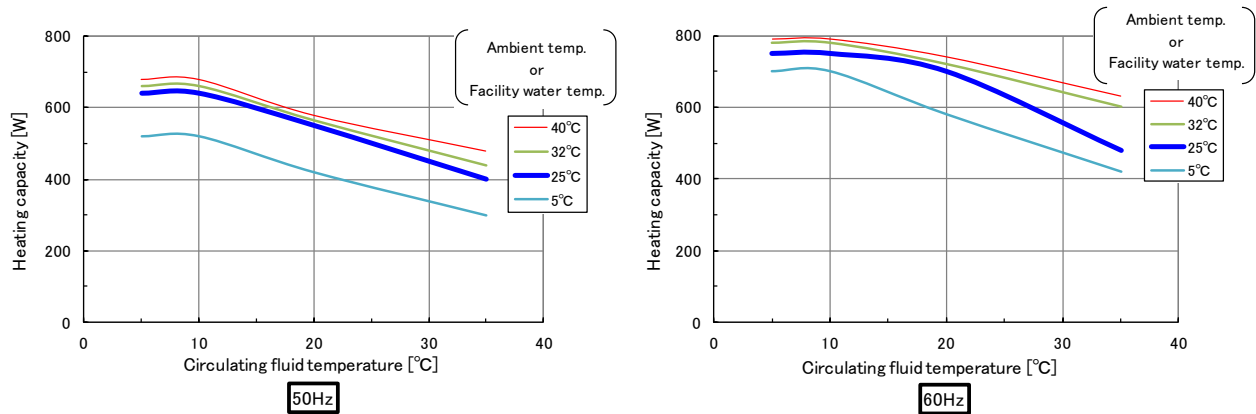

Fig 9-13 Heating capacity (HRR024-A/W-20,HRR030-A/W-20)

9.6 Pump capacity

9.6.1 HRR012/018/024/030-A/W-*

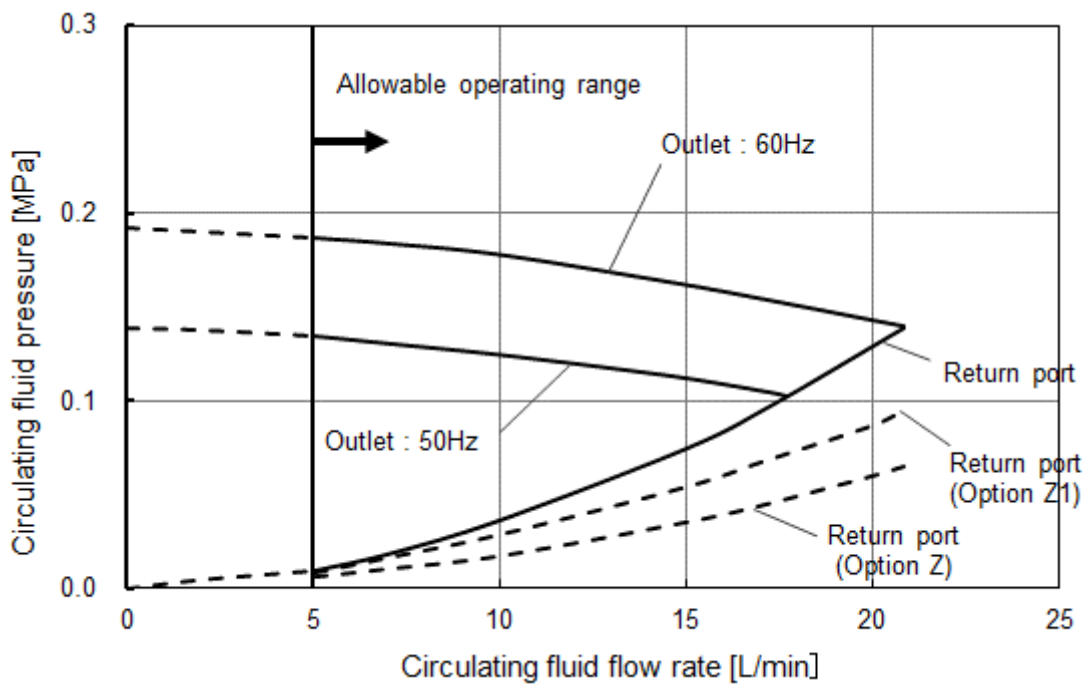

Fig 9-14 Pump capacity(HRR012/018/024/030-A/W-*)

9.6.2 HRR012/018-A/W-10-T/MT

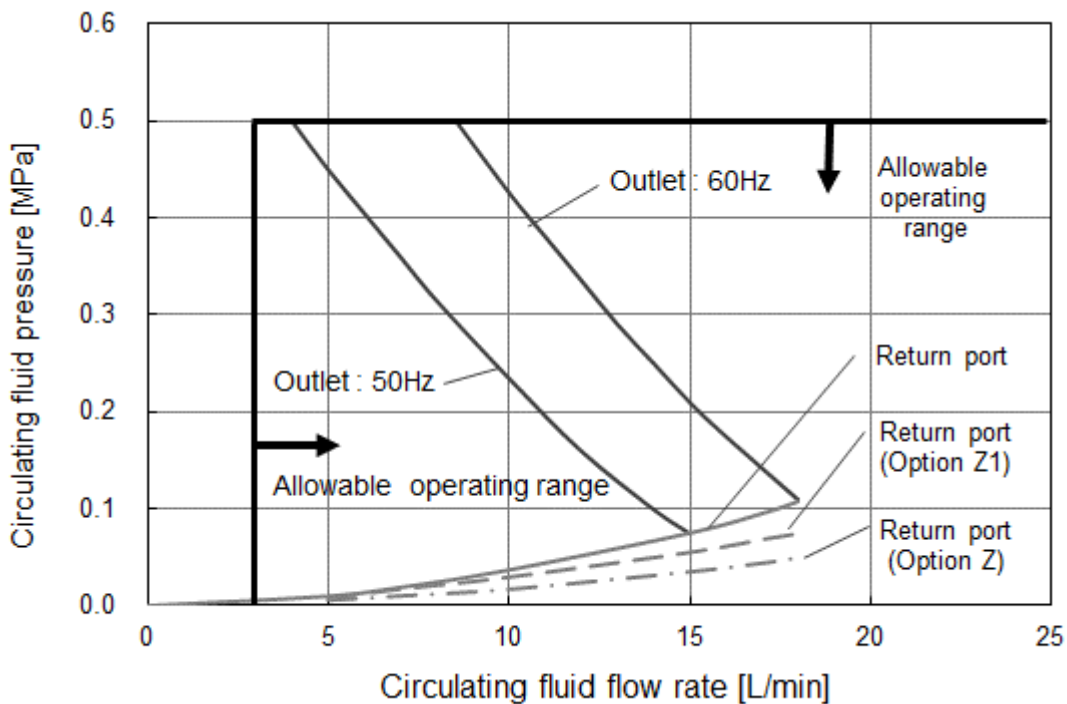

Fig 9-15 Pump capacity(HRR012/018-A/W-10-T/MT)

9.6.3 HRR012/018/024/030-A/W-20-T

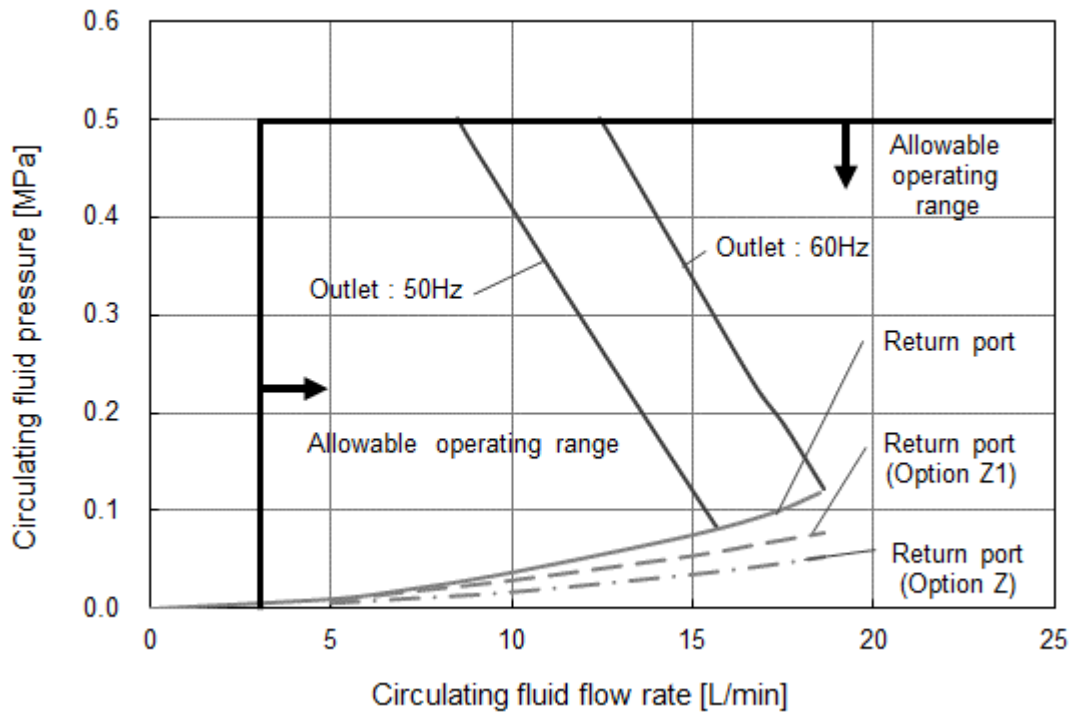

Fig 9-16 Pump capacity(HRR012/018/024/030-A/W-20-T)

9.6.4 HRR012/018/024/030-A/W-20-MT

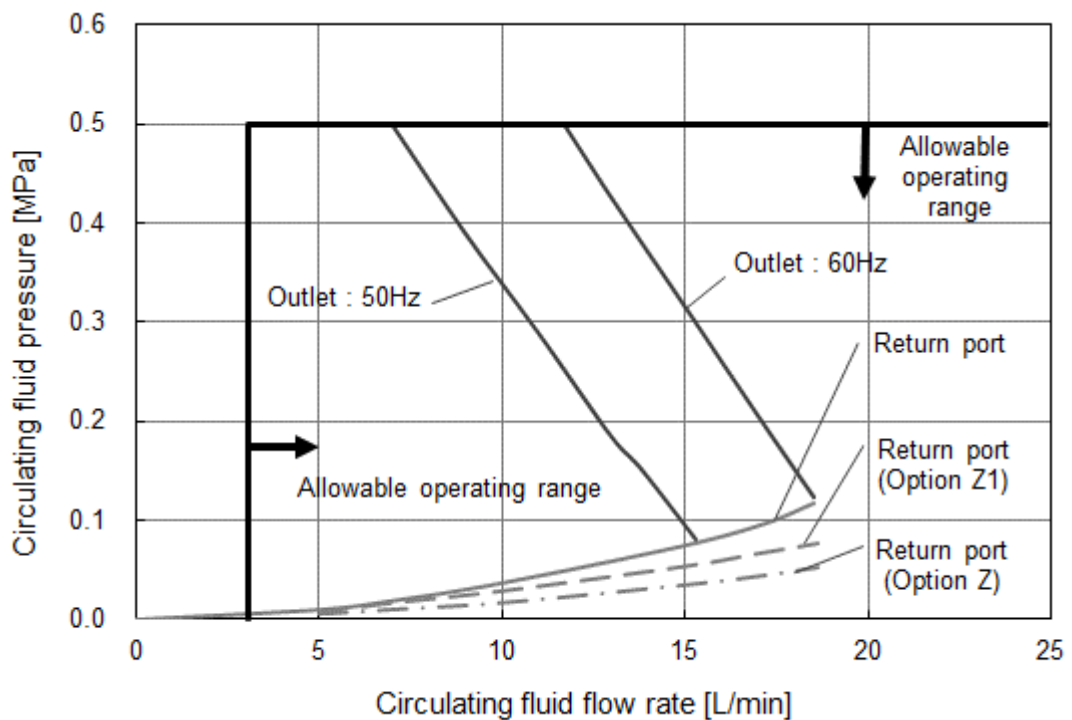

Fig 9-17 Pump capacity(HRR012/018/024/030-A/W-20-MT)

9.6.5 HRR012/018/024/030-A/W-20-T1

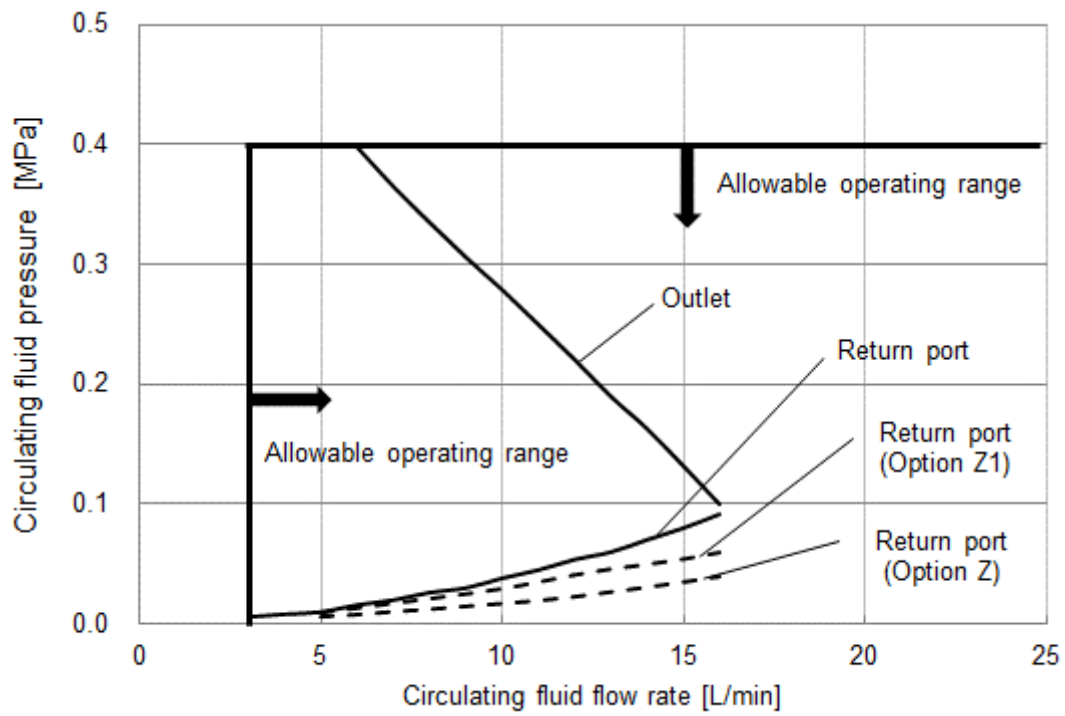
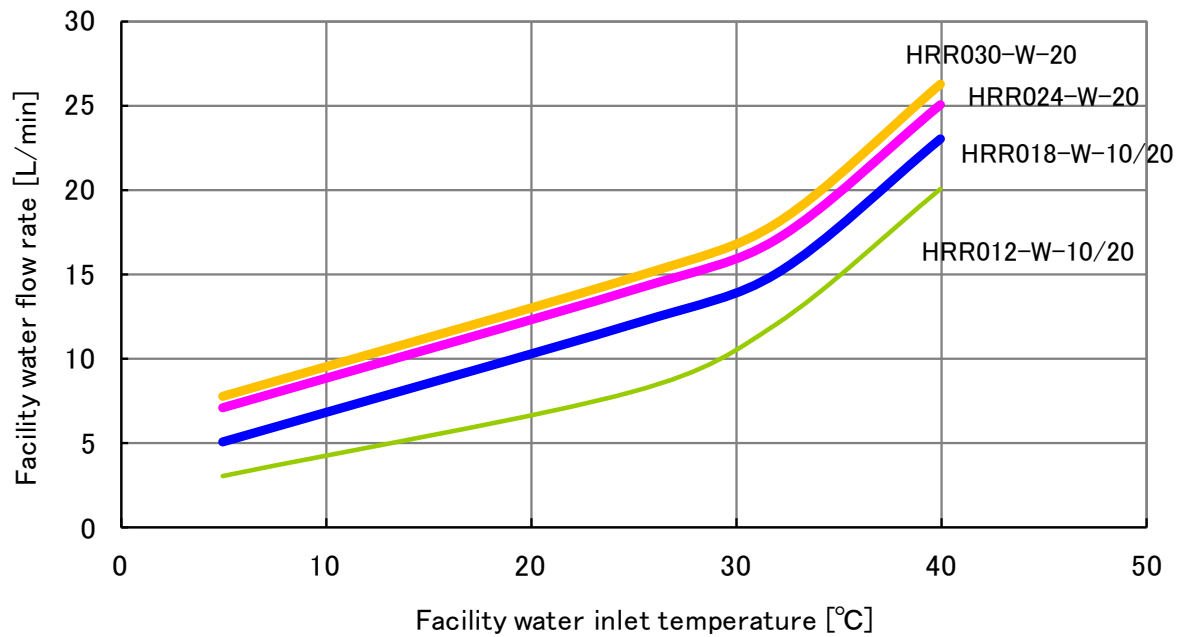

Fig 9-18 Pump capacity(HRR012/018/024/030-A/W-20-T1)

9.7 Required facility water flow (for water-cooled type)



*The amount of the facility water for the option with rated circulating fluid, cooling capacity which is described in fig.9-7 to 9-10

Fig 9-19 Required facility water flow (for water-cooled type)

9.8 Types of Hazard Labels

To ensure the safety of the operators, potential hazards are classified and marked with warning labels.

Read this section before starting any work on the product.

■ Electric shock warning

⚠ WARNING	
	<p>This symbol stands for a possible risk of electric shock.</p> <p>The product is operated at high voltage and contains uncovered live terminals inside.</p> <ul style="list-style-type: none">● DO NOT operate the product without cover panels fitted.● DO NOT work inside this product unless you have been trained to

9.8.1 Locations of Hazard Labels

There are various warning labels on the product to show the potential hazards.

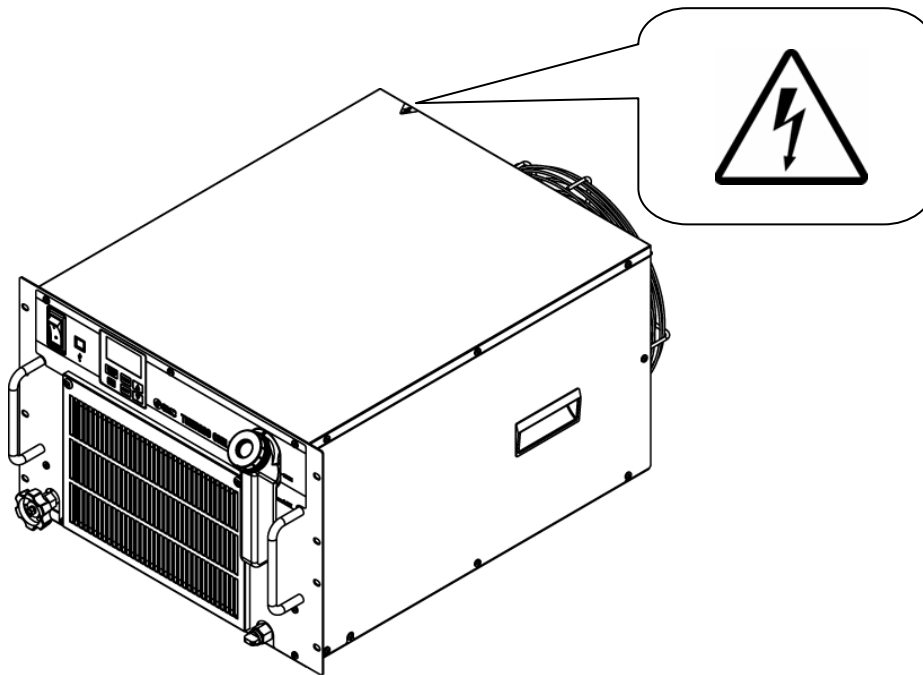

Fig.9-20 Locations of Hazard Labels

Chapter 10 Product Warranty

1. Period

The warranty period of the product is 1 year in service or 1.5 years after the product is delivered, whichever is first.

The warranty period of the product is 1 year in service or 1.5 years after the product is delivered, whichever is first.

2. Scope

For any failure reported within the warranty period which is clearly our responsibility, replacement parts will be provided. In that case, removed parts shall become the property of SMC.

This guarantee applies only to our product independently, and not to any other damage incurred due to the failure of the product.

3. Content

1. We guarantee that the product will operate normally if it is installed under maintenance and control in accordance with the Operation Manual, and operated under the conditions specified in the catalog or contracted separately.
2. We guarantee that the product does not have any defects in components, materials or assembly.
3. We guarantee that the product complies with the outline dimensions provided.
4. The following situations are out of scope of this warranty.
 - (1) The product was incorrectly installed or connected with other equipment.
 - (2) The product was under insufficient maintenance and control or incorrectly handled.
 - (3) The product was operated outside of the specifications.
 - (4) The product was modified or altered in construction.
 - (5) The failure was a secondary failure of the product caused by the failure of equipment connected to the product.
 - (6) The failure was caused by a natural disaster such as an earthquake, typhoon, or flood, or by an accident or fire.
 - (7) The failure was caused by operation different from that shown in the Operation Manual or outside of the specifications.
 - (8) The checks and maintenance specified (daily checks and regular checks) were not performed.
 - (9) The failure was caused by the use of circulating fluid or facility water other than those specified.
 - (10) The failure occurred naturally over time (such as discoloration of a painted or plated face).
 - (11) The failure does not affect the functioning of the product (such as new sounds, noises and vibrations).
 - (12) The failure was due to the "Installation Environment" specified in the Operation Manual.
 - (13) The failure was caused by the customer disregarding "6. Request to customers".

4. Agreement

If there is any doubt about anything specified in "2. Scope" and "3. Content", it shall be resolved by agreement between the customer and SMC.

5. Disclaimer

- (1) Expenses for daily and regular checks
- (2) Expenses for repairs performed by other companies
- (3) Expenses for transfer, installation and removal of the product
- (4) Expenses for replacement of parts other than those in this product, or for the supply of liquids
- (5) Inconvenience and loss due to product failure (such as telephone bills, compensation for workplace closure, and commercial losses)
- (6) Expenses and compensation not covered in "2. Scope".

6. Request to customers

Proper use and maintenance are essential to assure safe use of this product. Be sure to satisfy the following preconditions. Please note that we may refuse to carry out warranted repair if these preconditions have been disregarded.

- (1) Use the product following the instructions for handling described in the Operation Manual.
- (2) Perform checks and maintenance (daily checks and regular checks) specified in the Operation Manual and Maintenance Manual.
- (3) Record the check and maintenance results on the daily check sheet attached to the Operation Manual and Maintenance Manual.

7. Request for Warranted Repair

For warranted repair, please contact the supplier you purchased this product from. Warranted repair shall be on a request basis.

Repair shall be provided free of charge in accordance with the warranty period, preconditions and terms defined above. Therefore, a fee will be charged for any repairs if a failure is detected after the end of the warranty period.

Revision	
Revision I	: [May.2022]

SMC Corporation

4-14-1, Sotokanda, Chiyoda-ku, Tokyo 101-0021 JAPAN

Tel: + 81 3 5207 8249 Fax: +81 3 5298 5362

URL <https://www.smcworld.com>

Note: Specifications are subject to change without prior notice and any obligation on the part of the manufacturer.

© 2022 SMC Corporation All Rights Reserved