



Operation Manual

PRODUCT NAME

**MICRO MIST
SEPARATOR REGULATOR**

MODEL/ Series

AWD20-(F,N)01 ~ (F,N)02(B,C,E,G,H)(-1,2,6,C,J,N,R,Z)

AWD30-(F,N)02 ~ (F,N)03(B,C,D,E,G,H)(-1,2,6,8,J,N,R,W,Z)

AWD40-(F,N)02 ~ (F,N)04(B,C,D,E,G,H)(1,2,6,8,J,N,R,W,Z)

SMC Corporation

Contents

	PAGE
1. SAFETY INSTRUCTIONS	1~5
2. APPLICATION	6
3. SPECIFICATIONS	6
4. HOW TO ORDER	6
5. MAXIMUM APPLICABLE FLOW RATE	7
6. TROUBLESHOOTING	8
7. CONSTRUCTION / PARTS LIST	9
8. BOWL ASSEMBLY SPECIFICATIONS	10~12
9. HOW TO ORDER	13~15
10. DISASSEMBLY DRAWING	16~18
11. DIMENSIONS	19



MICRO MIST SEPARATOR REGULATOR Safety Instructions

These safety instructions are intended to prevent hazardous situations and/or equipment damage. These instructions indicate the level of potential hazard with the labels of "Caution," "Warning" or "Danger." They are all important notes for safety and must be followed in addition to International Standards (ISO/IEC), Japan Industrial Standards (JIS)*1) and other safety regulations*2).

*1) ISO 4414: Pneumatic fluid power -- General rules relating to systems
ISO 4413: Hydraulic fluid power -- General rules relating to systems
IEC 60204-1: Safety of machinery -- Electrical equipment of machines (Part 1: General requirements)
ISO 10218-1992: Manipulating industrial robots -- Safety
JIS B 8370: General rules for pneumatic equipment.
JIS B 8361: General rules for hydraulic equipment.
JIS B 9960-1: Safety of machinery -- Electrical equipment for machines. (Part 1: General requirements)
JIS B 8433-1993: Manipulating industrial robots - Safety. etc.

*2) Labor Safety and Sanitation Law, etc.



Caution Operator error could result in injury or equipment damage.



Warning Operator error could result in serious injury or loss of life.



Danger In extreme conditions, there is a possibility of serious injury or loss of life.

Warning

1. The compatibility of the product is the responsibility of the person who designs the equipment or decides its specifications.

Since the product specified here is used under various operating conditions, its compatibility with specific equipment must be decided by the person who designs the equipment or decides its specifications based on necessary analysis and test results.

The expected performance and safety assurance of the equipment will be the responsibility of the person who has determined its compatibility with the product.

This person should also continuously review all specifications of the product referring to its latest catalog information, with a view to giving due consideration to any possibility of equipment failure when configuring the equipment.

2. Only personnel with appropriate training should operate machinery and equipment.

The product specified here may become unsafe if handled incorrectly.

The assembly, operation and maintenance of machines or equipment including our products must be performed by an operator who is appropriately trained and experienced.

3. Do not service or attempt to remove product and machinery/equipment until safety is confirmed.

The inspection and maintenance of machinery/equipment should only be performed after measures to prevent falling or runaway of the driven objects have been confirmed.

When the product is to be removed, confirm that the safety measures as mentioned above are implemented and the power from any appropriate source is cut, and read and understand the specific product precautions of all relevant products carefully.

Before machinery/equipment is restarted, take measures to prevent unexpected operation and malfunction.

4. Contact SMC beforehand and take special consideration of safety measures if the product is to be used in any of the following conditions.

1) Conditions and environments outside of the given specifications, or use outdoors or in a place exposed to direct sunlight.

2) Installation on equipment in conjunction with atomic energy, railways, air navigation, space, shipping, vehicles, military, medical treatment, combustion and recreation, or equipment in contact with food and beverages, emergency stop circuits, clutch and brake circuits in press applications, safety equipment or other applications unsuitable for the standard specifications described in the product catalog.

3) An application which could have negative effects on people, property, or animals requiring special safety analysis.

4) Use in an interlock circuit, which requires the provision of double interlock for possible failure by using a mechanical protective function, and periodical checks to confirm proper operation.



MICRO MIST SEPARATOR REGULATOR Safety Instructions

Caution

The product is provided for use in manufacturing industries.

The product herein described is basically provided for peaceful use in manufacturing industries. If considering using the product in other industries, consult SMC beforehand and exchange specifications or a contract if necessary.
If anything is unclear, contact your nearest sales branch.

Limited warranty and Disclaimer/Compliance Requirements

The product used is subject to the following “Limited warranty and Disclaimer” and “Compliance Requirements”.

Read and accept them before using the product.

Limited warranty and Disclaimer

The warranty period of the product is 1 year in service or 1.5 years after the product is delivered. Also, the product may have specified durability, running distance or replacement parts. Please consult your nearest sales branch.

For any failure or damage reported within the warranty period which is clearly our responsibility, a replacement product or necessary parts will be provided.

This limited warranty applies only to our product independently, and not to any other damage incurred due to the failure of the product.

Prior to using SMC products, please read and understand the warranty terms and disclaimers noted in the specified catalog for the particular products.

Compliance Requirements

When the product is exported, strictly follow the laws required by the Ministry of Economy, Trade and Industry (Foreign Exchange and Foreign Trade Control Law).

Precautions for design



WARNING

- ① External parts including the bonnet, handle, cover are made of resin. Organic solvents including synthetic fluid, chemicals including acetone, alcohol, ethylene chloride, sulphuric acid, nitrate, hydrochloric acid, cutting oil, kerosene, gasoline, lock material of screw are harmful. Don't use the regulator where containing those.
- ② Avoid the application where charge and discharge of pressure to standard bowl is switched frequently. The bowl may be broken. For this kind of application, the metal bowl is recommended.
- ③ Consult SMC if no leakage is allowed due to the environment, or operating fluid is not air
- ④ Protect from ultra violet ray and radiation heat by shield.
- ⑤ Safety device needs to be installed if output pressure exceeding set pressure lead to cause the breakage of outlet device and equipment or malfunction.



CAUTION

- ① The use outside specifications is prohibited.
- ② Air consumption from release port is 0.1L/min(ANR) or less.
- ③ AD17 and 27 with auto drain may leak the drain pooled there during exhaust of pressure. (This leakage is allowed in their constructions and not failure.) Be sure to connect piping for drain.

Selection



WARNING

- ① Mineral grease used for internal sliding surface and packing may leak to the outlet. Please contact SMC if this is a problem.
- ② Residual pressure(outlet pressure) is not released even if releasing inlet pressure. Please install the check valve separately in parallel when you eliminated residual pressure.
- ③ Long absence of operation or operation with outlet circuit sealed or balance circuit may cause pressure fluctuation in outlet set pressure. Please consult SMC if this is a problem.
- ④ Set pressure of outlet pressure shall be 85% or less of inlet pressure. Pressure over 85% makes operation susceptible to flow and inlet pressure which lead to cause unstable operation.
- ⑤ Maximum set pressure range in the spec. has margin. Pressure set may be higher than the maximum value.
- ⑥ If regulator is used with circuit which require high exhaust sensitivity or set precision, please consult SMC.
- ⑦ N.O type auto drain should be used under the following requirements to avoid operating failure.
Output of compressor: 0.75kW or more.
Discharged flow rate: 100L/min (ANR) or more.
If multiple auto drains are used, confirm used compressor has capacity over the result of multiplying the above capacity and the number of used auto drains.
[For example, in case of two auto drain, the compressor need the capacity over 1.5kW [200L/min (ANR)].]
- ⑧ N.C. type auto drain should be used under the following requirements to avoid operating failure.
Operating pressure: 0.1MPa at min. for AD17 and 27, 0.15MPa at min. for AD37 and 47.

Installation



CAUTION

- ① Connect the regulator ensuring the direction of "IN" and "OUT" for air direction or an arrow. Wrong connection lead to cause malfunction.
- ② Install vertically so that outlet of drain would turn downward. Use with the outlet of drain turned lateral or upward causes malfunction.
- ③ Keep the space for maintenance and operation on the top, bottom and front face. The required space is shown on 「11. Dimensions」 (P19).
- ④ Don't drop nor apply impact during transportation or installation. gauge. These lead to cause precision failure of pressure .
- ⑤ Don't install where highly humid or temperature is high. Or pressure gauge may malfunction.

Adjustment



WARNING

- ① Adjust the pressure ensuring inlet pressure and outlet pressure. Excessive rotation may cause internal parts.
- ② Operate the pressure adjusting handle manually. Tools may break the handle.



CAUTION

- ① Check primary pressure before setting up.
- ② For the regulator with the pressure gauge, don't apply pressure over the maximum scale of the pressure gauge in order to protect the gauge.
- ③ Adjust pressure incrementally. Pressure may become lower than set pressure if adjusted by decreasing the value. Rotate the handle clockwise to raise the set pressure. Counterclockwise, reduce the pressure
- ④ Outlet pressure may rise if eliminate the inlet pressure after pressure setting and supply pressure again. The pressure becomes close to the set pressure after air is consumed in outlet.
- ⑤ Outlet pressure might change if uses for a long time. Please confirm set pressure regularly.

Piping



WARNING

- ① Flash or clean piping before piping to eliminate swarf, cutting oil, solid foreign material. Remaining of these lead to cause malfunction.
- ② When screw in piping or fitting, avoid entering of chips and sealing materials from piping screws into the inside of equipment. Or malfunction is led to occur. When use sealing tapes, leave 1.5~2 threads of a screw and starts taping.
- ③ Hold the female screw side and screw in piping with recommended tightening torque. Insufficient tightening torque lead to cause loose piping or sealing failure. Excessive torque may lead to cause screw breakage. Tightening without holding female screw side applies 'excessive force to the piping bracket which lead to cause breakage.

Recommended torque		unit: N·m		
Screw	1/8	1/4	3/8	1/2
Torque	7~9	12~14	22~24	28~30

- ④ Don't apply any torsional moment, or bending moment except the weight of the regulator itself. External pipings need its support separately. Hard piping like steel tube is susceptible to excessive moment load or vibration. Insert the flexible tube to cancel the influence
- ⑤ Drain guide is not equipped with valve function. Be sure to connect piping for drain. No piping for drain allows the drain and compressed air to exhaust freely. Also, the piping should be performed with drain guide held by spanner to prevent breakage of bowl.
- ⑥ The piping for drain from auto drain should be connected under the following requirements to avoid operating failure.
AD17, 27: I.D. ϕ 2.5 (ϕ 3/32") at min., Length 5m (200") at max.
AD37, 47(N): I.D. ϕ 4 (ϕ 3/16") at min., Length 5m (200") at max.
AD38, 48(N): I.D. ϕ 6.5 (ϕ 1/4") at min., Length 5m (200") at max.

Air Source



WARNING

- ① Use clean air. Compressed air containing chemicals, organic solvent, synthetic oil or corrosive gas may lead to cause breakage of parts or malfunction.
- ② Air containing much drain lead to cause malfunction. Install the air drier or the after-cooler before the mist separator regulator.



CAUTION

- ① Please install the air filter in the inlet of the mist separator regulator as Prifilta to avoid stopped up at the early clog of the element.

Maintenance



WARNING

- ① Maintenance or check should be done by following the procedure in the operation manual. Incorrect handling of the product may cause breakage or malfunction of the equipment or device.
- ② Perform periodical check to find crack, flaw or other deterioration on resin bowl. If any of them is seen, as malfunction is caused, replace with new bowl or metal bowl.
- ③ Check the dirt of resin bowl periodically. If any dirt is seen, replace with new bowl. And if removing off the dirt by washing instead of replacement, never use washing material other than neutral detergent. Otherwise, the bowl is damaged.
- ④ Replace the element before 2 years passed since purchase or pressure drop from initial outlet pressure reaches 0.1MPa. Or the element is broken.
- ⑤ Open and close drain cock manually. Open and close by a too may damage the drain cock.
- ⑥ Drain the bowl by opening drain cock before the drain level in the bowl reaches the bottom end of the element.



CAUTION

- ① For First-aid for setting failure or leakage, check the internal valve sliding surface or the valve seat before giving first-aid treatment.
- ② Check the element periodically and replace it with new one if necessary.
If it is found that secondary pressure lowers or the flow is restricted, check the condition of element.
- ③ The manual exhaust for emergency case can be performed by counterclockwise rotation of the handle in AD17 and 27. (○←direction)
For AD37, 38, 47 and 48, rotate the drain cock counterclockwise in that case.(○←direction)

2. APPLICATION

This instrument aims at , eliminating excess saturated water,oil of the air line and solid foreign material,pressure controlling of air lines.

3. SPECIFICATIONS

Model	AWD20	AWD30	AWD40
Port size	1/8, 1/4	1/4, 3/8	1/4, 3/8, 1/2
Fluid	Air		
Proof pressure	1.5MPa		
Max. operating pressure	1.0MPa		
Note1) Set pressure range	0.05~0.85MPa		
Note2) Gauge port size	1/8		1/4
Relieving pressure	Set pressure plus 0.05MPa {When relieving flow is 0.1L/min(ANR) }		
Ambient and fluid temperature	-5~60°C(Should be no freezing)		
Filtration	0.01μ m(95% particles size collection)		
Note3) Oil mist density at the out side	MAX.0.1mg/m ³ (ANR)(≒0.8ppm)		
Note4) Flow rate [l/min(ANR)]	90	180	450
Drain capacity (cm ³)	8	25	45
Drain guide port size	1/8	1/4	1/4
Construction	Relieving style		
Weight (kg)	0.44kg	0.59kg	1.25kg
Note5) Bowl guard	△	○	○

Note1) The range of set pressure for an auto drain (N.O. type):0.1~0.85MPa.

for an auto drain (N.C. type):0.1~0.85MPa(AWD20),0.15~0.85MPa(AWD30/40)

Note2) Square embedded pressure gauge.Without pressure gauge mounting threads.

Note3) When oil mist density of the compressor exhaust is 30mgf/Nm³(ANR).

A little amount of grease is used for bowl O ring and other O rings.

Note4)The set pressure is 0.5MPa. (The rated flow is different according to the set pressure.)

If larger amount of air than the rated flow is supplied, the oil flows into the out side.

Note5) ○ : Combinable to standard △ : Combinable to option

4. HOW TO ORDER

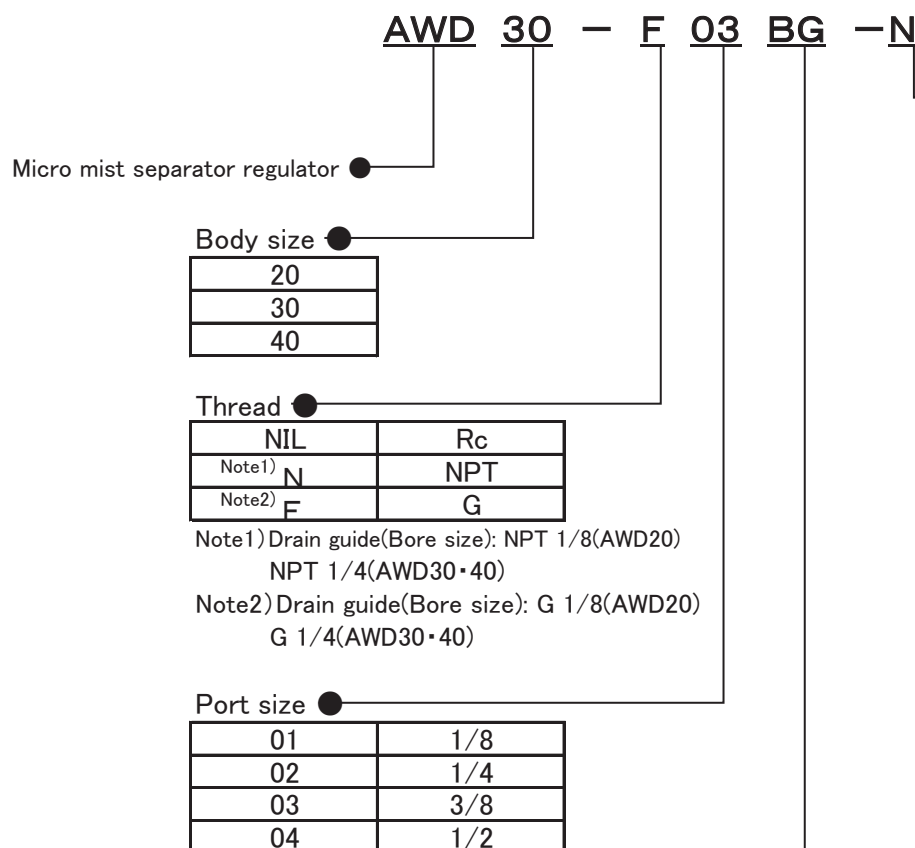

● Option

Symbol	Description	Applicable model
Note4) 1	Setting pressure 0.02~0.2MPa	AWD20~40
2	Metal bowl	AWD20~40
6	Nylon bowl	AWD20~40
8	Metal bowl with sight glass	AWD30·40
C	Bowl guard	AWD20
Note5) J	With drain guide 1/8	AWD20
	With drain guide 1/4	AWD30·40
N	Non-relieving style	AWD20~40
R	Flow direction: From right to left	AWD20~40
W	With drain cock and barb fitting (For nylon φ 6 × φ 4)	AWD30·40
Note6) Z	Name plate, Pressure gauge UNIT: PSI·° F	AWD20~40

When specifying more than one option,indicate symbols numerically then alphabetically.

Note4) Only the adjusting spring is different from the standard model.

Max. outlet pressure is 0.2MPa or more and it might go up.

Note5)Without valve function.

Note6) Thread: NPT

Z is applicable to only overseas because of new measurement law in Japan(SI unit).

● Accessory Note3)

Symbol	Description	Applicable model
Nil	—	—
B	With Bracket	AWD20~40
C	With float auto drain (N.C.)	AWD20~40
D	With float auto drain (N.O.)	AWD30·40
E	Square embedded pressure gauge (With limit indicator)	AWD30·40
G	Circular pressure gauge (With limit indicator)	AWD20~40
H	With set nut (Panel mounting)	AWD20~40

Note3)Accessory is packed together and is not mounted.

(Except type C,D,E)

5. MAXIMUM APPLICABLE FLOW RATE

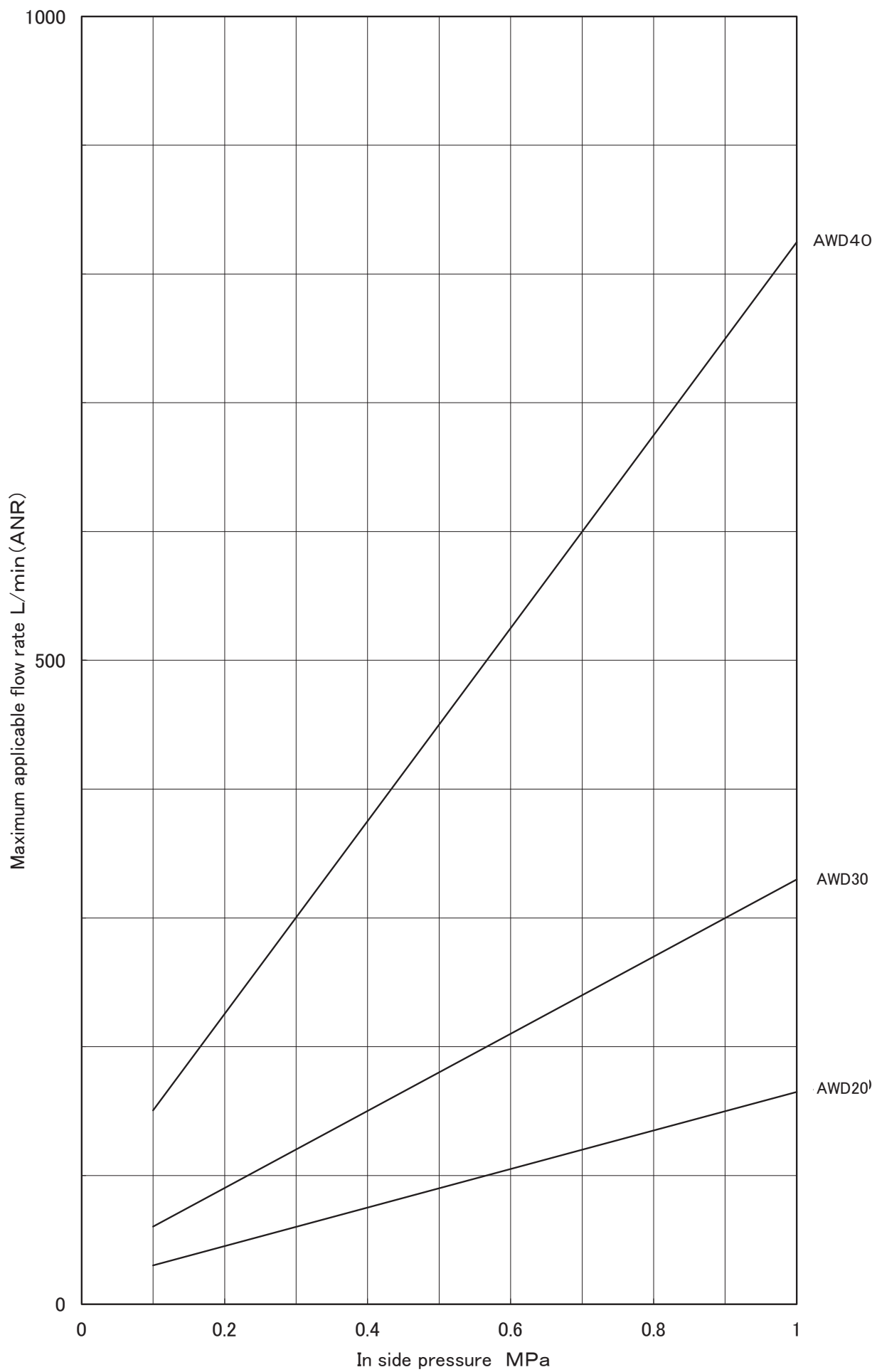

6. TROUBLESHOOTING

Refer to "7.CONSTRUCTION" (P9), "10.DISASSEMBLY DRAWING" (P16~P18).

TROUBLE		POSSIBLE CAUSE	REMEDY	Applicable model
Demarcation	Phenomenon			
Pressure	Pressure is not regulated	1. Opposite flow direction or opposite installation of regulator.	1. Check flow direction and install the regulator correctly if wrong.	AWD20~40
		2. Adjust spring is damaged.	2. Replace the adjust spring.	AWD20~40
		3. Valve spring is damaged.	3. Replace the valve spring.	AWD20~40
		4. Foreign materials caught in valve seat or valve "O" ring.	4. Remove the valve guide to clean valve, valve seat and the valve "O" ring. Then, grease up the valve "O" ring and the sliding surface.	AWD20~40
		5. Valve rubber seat is damaged.	5. Replace the valve.	AWD20~40
	Set pressure does not return to zero when pressure handle is loosened	1. Foreign materials caught in valve seat or valve "O" ring.	1. Remove the valve guide to clean valve, valve seat and the valve "O" ring. Then, grease up the valve "O" ring and the sliding surface.	AWD20~40
		2. Valve rubber seat is damaged.	2. Replace the valve.	AWD20~40
		3. Valve spring is damaged.	3. Replace the valve spring.	AWD20~40
4. Valve adheres to the valve guide.		4. Wash the sliding surface of valve "O" ring and grease up.	AWD20~40	
Flow rate	Large air resistance reduces flow rate.	1. Clog of the element.	1. Replace the element.	AWD20~40
Air leaks	Air leaks from the bonnet exhaust port	1. Diaphragm is damaged.	1. Replace the diaphragm assembly.	AWD20~40
		2. Foreign material is caught in the relieving valve seat.	2. Clean the relieving valve seat, or replace the diaphragm assembly.	AWD20~40
		3. Foreign material is caught in the valve seat of valve "O" ring.	3. Remove the valve guide to clean valve, valve seat and the valve "O" ring. Then, grease up the valve "O" ring and the sliding surface.	AWD20~40
		4. Valve rubber seat is damaged.	4. Replace the valve.	AWD20~40
		5. Back pressure exceeding the set pressure is applied to the outlet.	5. Revise the air circuit so that back pressure does not exceed the set pressure.	AWD20~40
	Air leaks between the bonnet and the body.	1. Loosened bonnet.	1. Fasten the bonnet.	AWD20~40
		2. Diaphragm is damaged.	2. Replace the diaphragm assembly.	AWD20~40
	Air leaks from the bowl and the body.	1. Breakage of "O" ring.	1. Replace the "O" ring. Grease up before assembling.	AWD20~40
	Air leaks from the bowl.	1. Breakage of bowl.	1. Replace the bowl assembly or with metal bowl.	AWD20~40
	Air leaks from the drain cock.	1. The foreign matter caught in the valve of the drain cock, the drain cock.	1. Open the drain cock for a few seconds for blowing.	AWD20~40
2. Breakage of the seating part of the drain cock		2. Replace the bowl assembly.	AWD20~40	
Operational	Draining isn't performed though the drain cock is opened.	1. Clog of outlet of the drain cock due to solid foreign matter etc.	1. Replace the bowl assembly.	AWD20~40
	Too much drain comes from the piping of secondary side.	1. Drain level in the bowl reaches the bottom end of the element.	1. Draining and replace the element.	AWD20~40

Note) The grease used recommends Mitsubishi diamond multipurpose No.2.

7. CONSTRUCTION/PARTS LIST

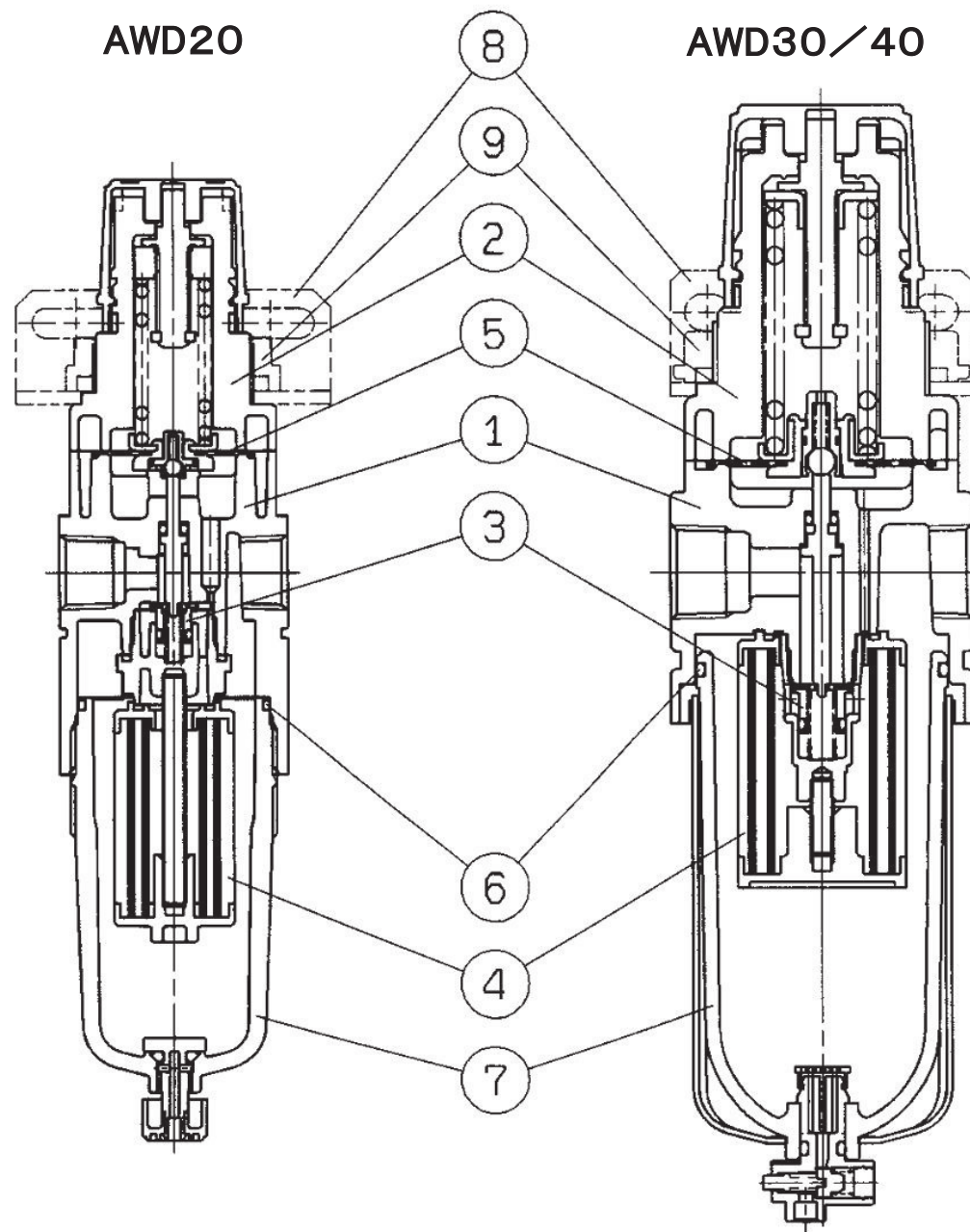

Component Parts

	Description	Material		Note
		AWD20	AWD30-40	
①	Body	Zinc die cast	Aluminium die cast	Painted platinum silver
②	Bonnet	POM		Painted black

Option/Replacement Parts

No.	Description	Thread	Bowl	Option	Material	Part no.		
						AWD20	AWD30	AWD40
③	Valve assembly	—	—	—	HNBR	AWM20P-090AS	AWM30P-090AS	AWM40P-090AS
④	Element assembly	—	—	—	—	AFD20P-060AS	AFD30P-060AS	AFD40P-060AS
⑤	Diaphragm assembly	—	—	—	Wheatherproof NBR	AR20P-150AS	AR30P-150AS	AR40P-150AS
		—	—	N	Wheatherproof NBR	AR20P-150AS-N	AR30P-150AS-N	AR40P-150AS-N
⑥	Bowl O ring	—	—	—	NBR	C2SFP-260S	C3SFP-260S	C4SFP-260S
⑦	Bowl assembly	Refer to 「8. SPECIFICATIONS OF BOWL ASSEMBLY」(P9~P11).						
	Auto drain (N.C.)							
	Auto drain (N.O.)							
⑧	Bracket assembly	—	—	—	Steel plate・POM	AW20P-270AS	AR30P-270AS	AR40P-270AS
⑨	Set nut	—	—	—	POM	AR20P-260S	AR30P-260S	AR40P-260S
⑩	Square embedded pressure gauge	—	—	—	—	GC3-10AS		
		NPT	—	Z	—	GC3-P10AS		
⑪	Pressure gauge cover	—	—	—	—	GC3P-010AS		
⑫	Circular pressure gauge	Rc	—	—	—	Note3) G36-10-01	Note4) G46-10-02	
		NPT	—	—	—	Note3) G36-10-N01	Note4) G46-10-N02	
			—	Z	—	Note3) G36-P10-N01	Note4) G46-P10-N02	
		G	—	—	—	Note3) G36-10-01	Note4) G46-10-02	
⑬	Pressure gauge adaptor assembly	Rc	—	—	Aluminium die cast	AR20P-310AS-01	AR20P-310AS-02	
		NPT	—	—	Aluminium die cast	AR20P-310AS-N01	AR20P-310AS-N02	
		G	—	—	Aluminium die cast	AR20P-310AS-F01	AR20P-310AS-F02	
⑭	Plug assembly	Rc	—	—	—	AR20P-320AS-01	AR40P-320AS-02	
		NPT	—	—	—	AR20P-320AS-N01	AR40P-320AS-N02	
		G	—	—	—	AR20P-320AS-F01	AR40P-320AS-F02	
⑮	Plug	Rc	—	—	PA	AR20P-370AS-01	AR20P-370AS-02	
		NPT	—	—	PA	AR20P-370AS-N01	AR20P-370AS-N02	
		G	—	—	PA	AR20P-370AS-01	AR20P-370AS-02	
⑯	Blanking plate assembly	—	—	—	—	AR20P-250AS		

Note1) Bracket and Set nut assembly.

Note2) With O ring (1 piece) and Mounting screws(2 pcs). For 0.2MPa part number: GC3-2AS/GC3-P2AS(NPT・Z).

Note3) For 0.2MPa part number: G36-2-01(Rc)/G36-2-N01(NPT)/G36-P2-N01(NPT・Z).

Note4) For 0.2MPa part number: G46-2-02(Rc)/G46-2-N02(NPT)/G46-P2-N02(NPT・Z).

Note5) The number in the table is corresponding to the number in structural drawing (above-mentioned figure) and 「8.SPECIFICATIONS OF BOWL ASSEMBLY」(P9~P11),「10.DISASSEMBLY DRAWING」(P16~P18)

8. BOWL ASSEMBLY SPECIFICATIONS

1) AWD20 Bowl assembly

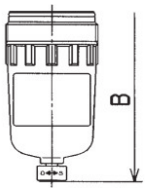
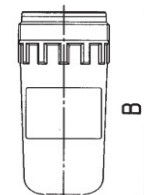
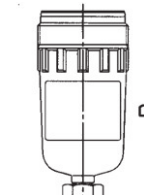
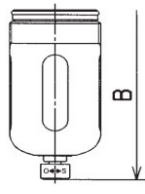
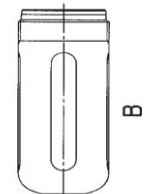
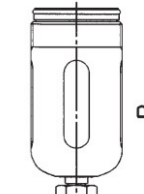
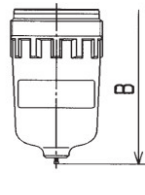
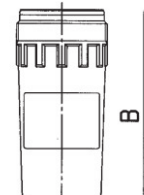
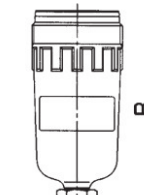
Accessory	—		Note2) C		—																															
Option	—	6	—	6	J	6J																														
External appearance drawing	<table border="1"> <tr><td colspan="2">Option「—」(Standard)</td></tr> <tr><td>Port thread</td><td>⑦Part No.</td></tr> <tr><td>Rc</td><td>C2SF</td></tr> <tr><td>G</td><td>C2SF</td></tr> <tr><td>NPT</td><td>C2SF(-Z)</td></tr> </table> 		Option「—」(Standard)		Port thread	⑦Part No.	Rc	C2SF	G	C2SF	NPT	C2SF(-Z)	<table border="1"> <tr><td colspan="2">Option「—」</td></tr> <tr><td>Port thread</td><td>⑦Part No.</td></tr> <tr><td>Rc</td><td>AD27</td></tr> <tr><td>G</td><td>AD27(-Z)</td></tr> <tr><td>NPT</td><td>AD27(-Z)</td></tr> </table> 		Option「—」		Port thread	⑦Part No.	Rc	AD27	G	AD27(-Z)	NPT	AD27(-Z)	<table border="1"> <tr><td colspan="2">Option「J」</td></tr> <tr><td>Port thread</td><td>⑦Part No.</td></tr> <tr><td>Rc</td><td>C2SF-J</td></tr> <tr><td>G</td><td>C2SFF-J</td></tr> <tr><td>NPT</td><td>C2SFN-J(Z)</td></tr> </table> 		Option「J」		Port thread	⑦Part No.	Rc	C2SF-J	G	C2SFF-J	NPT	C2SFN-J(Z)
Option「—」(Standard)																																				
Port thread	⑦Part No.																																			
Rc	C2SF																																			
G	C2SF																																			
NPT	C2SF(-Z)																																			
Option「—」																																				
Port thread	⑦Part No.																																			
Rc	AD27																																			
G	AD27(-Z)																																			
NPT	AD27(-Z)																																			
Option「J」																																				
Port thread	⑦Part No.																																			
Rc	C2SF-J																																			
G	C2SFF-J																																			
NPT	C2SFN-J(Z)																																			
Part No.	<table border="1"> <tr><td colspan="2">Option「6」</td></tr> <tr><td>Port thread</td><td>⑦Part No.</td></tr> <tr><td>Rc</td><td>C2SF-6</td></tr> <tr><td>G</td><td>C2SF-6</td></tr> <tr><td>NPT</td><td>C2SF-6(Z)</td></tr> </table>		Option「6」		Port thread	⑦Part No.	Rc	C2SF-6	G	C2SF-6	NPT	C2SF-6(Z)	<table border="1"> <tr><td colspan="2">Option「6」</td></tr> <tr><td>Port thread</td><td>⑦Part No.</td></tr> <tr><td>Rc</td><td>AD27-6</td></tr> <tr><td>G</td><td>AD27-6</td></tr> <tr><td>NPT</td><td>AD27-6(Z)</td></tr> </table>		Option「6」		Port thread	⑦Part No.	Rc	AD27-6	G	AD27-6	NPT	AD27-6(Z)	<table border="1"> <tr><td colspan="2">Option「6J」</td></tr> <tr><td>Port thread</td><td>⑦Part No.</td></tr> <tr><td>Rc</td><td>C2SF-6J</td></tr> <tr><td>G</td><td>C2SFF-6J</td></tr> <tr><td>NPT</td><td>C2SFN-6J(Z)</td></tr> </table>		Option「6J」		Port thread	⑦Part No.	Rc	C2SF-6J	G	C2SFF-6J	NPT	C2SFN-6J(Z)
Option「6」																																				
Port thread	⑦Part No.																																			
Rc	C2SF-6																																			
G	C2SF-6																																			
NPT	C2SF-6(Z)																																			
Option「6」																																				
Port thread	⑦Part No.																																			
Rc	AD27-6																																			
G	AD27-6																																			
NPT	AD27-6(Z)																																			
Option「6J」																																				
Port thread	⑦Part No.																																			
Rc	C2SF-6J																																			
G	C2SFF-6J																																			
NPT	C2SFN-6J(Z)																																			
Accessory	—		Note2) C		—																															
Option	C	6C	C	6C	CJ	6CJ																														
External appearance drawing	<table border="1"> <tr><td colspan="2">Option「C」</td></tr> <tr><td>Port thread</td><td>⑦Part No.</td></tr> <tr><td>Rc</td><td>C2SF-C</td></tr> <tr><td>G</td><td>C2SF-C</td></tr> <tr><td>NPT</td><td>C2SF-C(Z)</td></tr> </table> 		Option「C」		Port thread	⑦Part No.	Rc	C2SF-C	G	C2SF-C	NPT	C2SF-C(Z)	<table border="1"> <tr><td colspan="2">Option「C」</td></tr> <tr><td>Port thread</td><td>⑦Part No.</td></tr> <tr><td>Rc</td><td>AD27-C</td></tr> <tr><td>G</td><td>AD27-C</td></tr> <tr><td>NPT</td><td>AD27-C(Z)</td></tr> </table> 		Option「C」		Port thread	⑦Part No.	Rc	AD27-C	G	AD27-C	NPT	AD27-C(Z)	<table border="1"> <tr><td colspan="2">Option「CJ」</td></tr> <tr><td>Port thread</td><td>⑦Part No.</td></tr> <tr><td>Rc</td><td>C2SF-CJ</td></tr> <tr><td>G</td><td>C2SFF-CJ</td></tr> <tr><td>NPT</td><td>C2SFN-CJ(Z)</td></tr> </table> 		Option「CJ」		Port thread	⑦Part No.	Rc	C2SF-CJ	G	C2SFF-CJ	NPT	C2SFN-CJ(Z)
Option「C」																																				
Port thread	⑦Part No.																																			
Rc	C2SF-C																																			
G	C2SF-C																																			
NPT	C2SF-C(Z)																																			
Option「C」																																				
Port thread	⑦Part No.																																			
Rc	AD27-C																																			
G	AD27-C																																			
NPT	AD27-C(Z)																																			
Option「CJ」																																				
Port thread	⑦Part No.																																			
Rc	C2SF-CJ																																			
G	C2SFF-CJ																																			
NPT	C2SFN-CJ(Z)																																			
Part No.	<table border="1"> <tr><td colspan="2">Option「6C」</td></tr> <tr><td>Port thread</td><td>⑦Part No.</td></tr> <tr><td>Rc</td><td>C2SF-6C</td></tr> <tr><td>G</td><td>C2SF-6C</td></tr> <tr><td>NPT</td><td>C2SF-6C(Z)</td></tr> </table>		Option「6C」		Port thread	⑦Part No.	Rc	C2SF-6C	G	C2SF-6C	NPT	C2SF-6C(Z)	<table border="1"> <tr><td colspan="2">Option「6C」</td></tr> <tr><td>Port thread</td><td>⑦Part No.</td></tr> <tr><td>Rc</td><td>AD27-6C</td></tr> <tr><td>G</td><td>AD27-6C</td></tr> <tr><td>NPT</td><td>AD27-6C(Z)</td></tr> </table>		Option「6C」		Port thread	⑦Part No.	Rc	AD27-6C	G	AD27-6C	NPT	AD27-6C(Z)	<table border="1"> <tr><td colspan="2">Option「6CJ」</td></tr> <tr><td>Port thread</td><td>⑦Part No.</td></tr> <tr><td>Rc</td><td>C2SF-6CJ</td></tr> <tr><td>G</td><td>C2SFF-6CJ</td></tr> <tr><td>NPT</td><td>C2SFN-6CJ(Z)</td></tr> </table>		Option「6CJ」		Port thread	⑦Part No.	Rc	C2SF-6CJ	G	C2SFF-6CJ	NPT	C2SFN-6CJ(Z)
Option「6C」																																				
Port thread	⑦Part No.																																			
Rc	C2SF-6C																																			
G	C2SF-6C																																			
NPT	C2SF-6C(Z)																																			
Option「6C」																																				
Port thread	⑦Part No.																																			
Rc	AD27-6C																																			
G	AD27-6C																																			
NPT	AD27-6C(Z)																																			
Option「6CJ」																																				
Port thread	⑦Part No.																																			
Rc	C2SF-6CJ																																			
G	C2SFF-6CJ																																			
NPT	C2SFN-6CJ(Z)																																			
Accessory	—		Note2) C		—																															
Option	2		2		2J																															
External appearance drawing	<table border="1"> <tr><td colspan="2">Port thread ⑦Part No.</td></tr> <tr><td>Rc</td><td>C2SF-2</td></tr> <tr><td>G</td><td>C2SF-2</td></tr> <tr><td>NPT</td><td>C2SF-2(Z)</td></tr> </table> 		Port thread ⑦Part No.		Rc	C2SF-2	G	C2SF-2	NPT	C2SF-2(Z)	<table border="1"> <tr><td colspan="2">Port thread ⑦Part No.</td></tr> <tr><td>Rc</td><td>AD27-2</td></tr> <tr><td>G</td><td>AD27-2</td></tr> <tr><td>NPT</td><td>AD27-2(Z)</td></tr> </table> 		Port thread ⑦Part No.		Rc	AD27-2	G	AD27-2	NPT	AD27-2(Z)	<table border="1"> <tr><td colspan="2">Port thread ⑦Part No.</td></tr> <tr><td>Rc</td><td>C2SF-2J</td></tr> <tr><td>G</td><td>C2SFF-2J</td></tr> <tr><td>NPT</td><td>C2SFN-2J(Z)</td></tr> </table> 		Port thread ⑦Part No.		Rc	C2SF-2J	G	C2SFF-2J	NPT	C2SFN-2J(Z)						
Port thread ⑦Part No.																																				
Rc	C2SF-2																																			
G	C2SF-2																																			
NPT	C2SF-2(Z)																																			
Port thread ⑦Part No.																																				
Rc	AD27-2																																			
G	AD27-2																																			
NPT	AD27-2(Z)																																			
Port thread ⑦Part No.																																				
Rc	C2SF-2J																																			
G	C2SFF-2J																																			
NPT	C2SFN-2J(Z)																																			
Part No.			<table border="1"> <tr><td colspan="2">Port thread ⑦Part No.</td></tr> <tr><td>Rc</td><td>AD27-2</td></tr> <tr><td>G</td><td>AD27-2</td></tr> <tr><td>NPT</td><td>AD27-2(Z)</td></tr> </table>		Port thread ⑦Part No.		Rc	AD27-2	G	AD27-2	NPT	AD27-2(Z)	<table border="1"> <tr><td colspan="2">Port thread ⑦Part No.</td></tr> <tr><td>Rc</td><td>C2SF-2J</td></tr> <tr><td>G</td><td>C2SFF-2J</td></tr> <tr><td>NPT</td><td>C2SFN-2J(Z)</td></tr> </table>		Port thread ⑦Part No.		Rc	C2SF-2J	G	C2SFF-2J	NPT	C2SFN-2J(Z)														
Port thread ⑦Part No.																																				
Rc	AD27-2																																			
G	AD27-2																																			
NPT	AD27-2(Z)																																			
Port thread ⑦Part No.																																				
Rc	C2SF-2J																																			
G	C2SFF-2J																																			
NPT	C2SFN-2J(Z)																																			

Note1) B in the table shows the total length of the product. Refer to "11. DIMENSIONS" (P19).

Note2) The lowest pressure is 0.1MPa.

Note3) The part with no. ⑦ includes ⑥ Bowl O ring. Refer to "10. DISASSEMBLY DRAWING" (P16~P18).

Note4) "Z" in the part number ⑦ is a option, and the unit of the pressure and the temperature are PSI and ° F.

Note5) Refer to "4. HOW TO ORDER" (P6) for an accessories symbol and option symbol.

2) Bowl assembly/Auto drain for AWD30

Accessory	—		Note2) C		Note2) D		—		—																																																																																																																													
Option	—	6	—	6	—	6	J	6J	W	6W																																																																																																																												
External appearance drawing																																																																																																																																						
Part no.	<table border="1"> <tr><td>Option 「-」 (Standard)</td><td></td></tr> <tr><td>Port thread</td><td>⑦Part no.</td></tr> <tr><td>Rc</td><td>C3SF</td></tr> <tr><td>G</td><td>C3SF</td></tr> <tr><td>NPT</td><td>C3SF(-Z)</td></tr> </table> <table border="1"> <tr><td>Option 「6」</td><td></td></tr> <tr><td>Port thread</td><td>⑦Part no.</td></tr> <tr><td>Rc</td><td>C3SF-6</td></tr> <tr><td>G</td><td>C3SF-6</td></tr> <tr><td>NPT</td><td>C3SF-6(Z)</td></tr> </table>		Option 「-」 (Standard)		Port thread	⑦Part no.	Rc	C3SF	G	C3SF	NPT	C3SF(-Z)	Option 「6」		Port thread	⑦Part no.	Rc	C3SF-6	G	C3SF-6	NPT	C3SF-6(Z)	<table border="1"> <tr><td>Option 「-」</td><td></td></tr> <tr><td>Port thread</td><td>⑦Part no.</td><td>D</td></tr> <tr><td>Rc</td><td>AD37</td><td>φ 10</td></tr> <tr><td>G</td><td>AD37N(-Z)</td><td>φ 3/8"</td></tr> <tr><td>NPT</td><td>AD37N(-Z)</td><td>φ 3/8"</td></tr> </table> <p>D: APPLICABLE TUBE EXTERNAL DIAMETER</p> <table border="1"> <tr><td>Option 「6」</td><td></td></tr> <tr><td>Port thread</td><td>⑦Part no.</td><td>D</td></tr> <tr><td>Rc</td><td>AD37-6</td><td>φ 10</td></tr> <tr><td>G</td><td>AD37N-6(Z)</td><td>φ 3/8"</td></tr> <tr><td>NPT</td><td>AD37N-6(Z)</td><td>φ 3/8"</td></tr> </table> <p>D: APPLICABLE TUBE EXTERNAL DIAMETER</p>		Option 「-」		Port thread	⑦Part no.	D	Rc	AD37	φ 10	G	AD37N(-Z)	φ 3/8"	NPT	AD37N(-Z)	φ 3/8"	Option 「6」		Port thread	⑦Part no.	D	Rc	AD37-6	φ 10	G	AD37N-6(Z)	φ 3/8"	NPT	AD37N-6(Z)	φ 3/8"	<table border="1"> <tr><td>Option 「-」</td><td></td></tr> <tr><td>Port thread</td><td>⑦Part no.</td><td>D</td></tr> <tr><td>Rc</td><td>AD38</td><td>φ 10</td></tr> <tr><td>G</td><td>AD38N(-Z)</td><td>φ 3/8"</td></tr> <tr><td>NPT</td><td>AD38N(-Z)</td><td>φ 3/8"</td></tr> </table> <p>D: APPLICABLE TUBE EXTERNAL DIAMETER</p> <table border="1"> <tr><td>Option 「6」</td><td></td></tr> <tr><td>Port thread</td><td>⑦Part no.</td><td>D</td></tr> <tr><td>Rc</td><td>AD38-6</td><td>φ 10</td></tr> <tr><td>G</td><td>AD38N-6(Z)</td><td>φ 3/8"</td></tr> <tr><td>NPT</td><td>AD38N-6(Z)</td><td>φ 3/8"</td></tr> </table> <p>D: APPLICABLE TUBE EXTERNAL DIAMETER</p>		Option 「-」		Port thread	⑦Part no.	D	Rc	AD38	φ 10	G	AD38N(-Z)	φ 3/8"	NPT	AD38N(-Z)	φ 3/8"	Option 「6」		Port thread	⑦Part no.	D	Rc	AD38-6	φ 10	G	AD38N-6(Z)	φ 3/8"	NPT	AD38N-6(Z)	φ 3/8"	<table border="1"> <tr><td>Option 「J」</td><td></td></tr> <tr><td>Port thread</td><td>⑦Part no.</td></tr> <tr><td>Rc</td><td>C3SF-J</td></tr> <tr><td>G</td><td>C3SFF-J</td></tr> <tr><td>NPT</td><td>C3SFN-J(Z)</td></tr> </table> <table border="1"> <tr><td>Option 「6J」</td><td></td></tr> <tr><td>Port thread</td><td>⑦Part no.</td></tr> <tr><td>Rc</td><td>C3SF-6J</td></tr> <tr><td>G</td><td>C3SFF-6J</td></tr> <tr><td>NPT</td><td>C3SFN-6J(Z)</td></tr> </table>		Option 「J」		Port thread	⑦Part no.	Rc	C3SF-J	G	C3SFF-J	NPT	C3SFN-J(Z)	Option 「6J」		Port thread	⑦Part no.	Rc	C3SF-6J	G	C3SFF-6J	NPT	C3SFN-6J(Z)	<table border="1"> <tr><td>Option 「W」</td><td></td></tr> <tr><td>Port thread</td><td>⑦Part no.</td><td>D</td></tr> <tr><td>Rc</td><td>C3SF-W</td><td>T0604</td></tr> <tr><td>G</td><td>C3SF-W</td><td>T0604</td></tr> <tr><td>NPT</td><td>C3SF-W(Z)</td><td>T0604</td></tr> </table> <p>D: APPLICABLE TUBE</p> <table border="1"> <tr><td>Option 「6W」</td><td></td></tr> <tr><td>Port thread</td><td>⑦Part no.</td><td>D</td></tr> <tr><td>Rc</td><td>C3SF-6W</td><td>T0604</td></tr> <tr><td>G</td><td>C3SF-6W</td><td>T0604</td></tr> <tr><td>NPT</td><td>C3SF-6W(Z)</td><td>T0604</td></tr> </table> <p>D: APPLICABLE TUBE</p>		Option 「W」		Port thread	⑦Part no.	D	Rc	C3SF-W	T0604	G	C3SF-W	T0604	NPT	C3SF-W(Z)	T0604	Option 「6W」		Port thread	⑦Part no.	D	Rc	C3SF-6W	T0604	G	C3SF-6W	T0604	NPT	C3SF-6W(Z)	T0604
Option 「-」 (Standard)																																																																																																																																						
Port thread	⑦Part no.																																																																																																																																					
Rc	C3SF																																																																																																																																					
G	C3SF																																																																																																																																					
NPT	C3SF(-Z)																																																																																																																																					
Option 「6」																																																																																																																																						
Port thread	⑦Part no.																																																																																																																																					
Rc	C3SF-6																																																																																																																																					
G	C3SF-6																																																																																																																																					
NPT	C3SF-6(Z)																																																																																																																																					
Option 「-」																																																																																																																																						
Port thread	⑦Part no.	D																																																																																																																																				
Rc	AD37	φ 10																																																																																																																																				
G	AD37N(-Z)	φ 3/8"																																																																																																																																				
NPT	AD37N(-Z)	φ 3/8"																																																																																																																																				
Option 「6」																																																																																																																																						
Port thread	⑦Part no.	D																																																																																																																																				
Rc	AD37-6	φ 10																																																																																																																																				
G	AD37N-6(Z)	φ 3/8"																																																																																																																																				
NPT	AD37N-6(Z)	φ 3/8"																																																																																																																																				
Option 「-」																																																																																																																																						
Port thread	⑦Part no.	D																																																																																																																																				
Rc	AD38	φ 10																																																																																																																																				
G	AD38N(-Z)	φ 3/8"																																																																																																																																				
NPT	AD38N(-Z)	φ 3/8"																																																																																																																																				
Option 「6」																																																																																																																																						
Port thread	⑦Part no.	D																																																																																																																																				
Rc	AD38-6	φ 10																																																																																																																																				
G	AD38N-6(Z)	φ 3/8"																																																																																																																																				
NPT	AD38N-6(Z)	φ 3/8"																																																																																																																																				
Option 「J」																																																																																																																																						
Port thread	⑦Part no.																																																																																																																																					
Rc	C3SF-J																																																																																																																																					
G	C3SFF-J																																																																																																																																					
NPT	C3SFN-J(Z)																																																																																																																																					
Option 「6J」																																																																																																																																						
Port thread	⑦Part no.																																																																																																																																					
Rc	C3SF-6J																																																																																																																																					
G	C3SFF-6J																																																																																																																																					
NPT	C3SFN-6J(Z)																																																																																																																																					
Option 「W」																																																																																																																																						
Port thread	⑦Part no.	D																																																																																																																																				
Rc	C3SF-W	T0604																																																																																																																																				
G	C3SF-W	T0604																																																																																																																																				
NPT	C3SF-W(Z)	T0604																																																																																																																																				
Option 「6W」																																																																																																																																						
Port thread	⑦Part no.	D																																																																																																																																				
Rc	C3SF-6W	T0604																																																																																																																																				
G	C3SF-6W	T0604																																																																																																																																				
NPT	C3SF-6W(Z)	T0604																																																																																																																																				
Accessory	—		Note2) C		Note2) D		—																																																																																																																															
Option	2		2		2		2J																																																																																																																															
External appearance drawing																																																																																																																																						
Part no.	<table border="1"> <tr><td>Port thread</td><td>⑦Part no.</td></tr> <tr><td>Rc</td><td>C3SF-2</td></tr> <tr><td>G</td><td>C3SF-2</td></tr> <tr><td>NPT</td><td>C3SF-2(Z)</td></tr> </table>		Port thread	⑦Part no.	Rc	C3SF-2	G	C3SF-2	NPT	C3SF-2(Z)	<table border="1"> <tr><td>Port thread</td><td>⑦Part no.</td><td>D</td></tr> <tr><td>Rc</td><td>AD37-2</td><td>φ 10</td></tr> <tr><td>G</td><td>AD37N-2(Z)</td><td>φ 3/8"</td></tr> <tr><td>NPT</td><td>AD37N-2(Z)</td><td>φ 3/8"</td></tr> </table> <p>D: APPLICABLE TUBE EXTERNAL DIAMETER</p>		Port thread	⑦Part no.	D	Rc	AD37-2	φ 10	G	AD37N-2(Z)	φ 3/8"	NPT	AD37N-2(Z)	φ 3/8"	<table border="1"> <tr><td>Port thread</td><td>⑦Part no.</td><td>D</td></tr> <tr><td>Rc</td><td>AD38-2</td><td>φ 10</td></tr> <tr><td>G</td><td>AD38N-2(Z)</td><td>φ 3/8"</td></tr> <tr><td>NPT</td><td>AD38N-2(Z)</td><td>φ 3/8"</td></tr> </table> <p>D: APPLICABLE TUBE EXTERNAL DIAMETER</p>		Port thread	⑦Part no.	D	Rc	AD38-2	φ 10	G	AD38N-2(Z)	φ 3/8"	NPT	AD38N-2(Z)	φ 3/8"	<table border="1"> <tr><td>Port thread</td><td>⑦Part no.</td></tr> <tr><td>Rc</td><td>C3SF-2J</td></tr> <tr><td>G</td><td>C3SFF-2J</td></tr> <tr><td>NPT</td><td>C3SFN-2J(Z)</td></tr> </table>		Port thread	⑦Part no.	Rc	C3SF-2J	G	C3SFF-2J	NPT	C3SFN-2J(Z)																																																																																						
Port thread	⑦Part no.																																																																																																																																					
Rc	C3SF-2																																																																																																																																					
G	C3SF-2																																																																																																																																					
NPT	C3SF-2(Z)																																																																																																																																					
Port thread	⑦Part no.	D																																																																																																																																				
Rc	AD37-2	φ 10																																																																																																																																				
G	AD37N-2(Z)	φ 3/8"																																																																																																																																				
NPT	AD37N-2(Z)	φ 3/8"																																																																																																																																				
Port thread	⑦Part no.	D																																																																																																																																				
Rc	AD38-2	φ 10																																																																																																																																				
G	AD38N-2(Z)	φ 3/8"																																																																																																																																				
NPT	AD38N-2(Z)	φ 3/8"																																																																																																																																				
Port thread	⑦Part no.																																																																																																																																					
Rc	C3SF-2J																																																																																																																																					
G	C3SFF-2J																																																																																																																																					
NPT	C3SFN-2J(Z)																																																																																																																																					
Accessory	—		Note2) C		Note2) D		—		Metal bowl with sight glass																																																																																																																													
Option	8		8		8		8J																																																																																																																															
External appearance drawing																																																																																																																																						
Part no.	<table border="1"> <tr><td>Port thread</td><td>⑦Part no.</td></tr> <tr><td>Rc</td><td>C3LF-8</td></tr> <tr><td>G</td><td>C3LF-8</td></tr> <tr><td>NPT</td><td>C3LF-8(Z)</td></tr> </table>		Port thread	⑦Part no.	Rc	C3LF-8	G	C3LF-8			NPT	C3LF-8(Z)	<table border="1"> <tr><td>Port thread</td><td>⑦Part no.</td></tr> <tr><td>Rc</td><td>AD37-8</td></tr> <tr><td>G</td><td>AD37N-8(Z)</td></tr> <tr><td>NPT</td><td>AD37N-8(Z)</td></tr> </table>		Port thread	⑦Part no.	Rc	AD37-8	G	AD37N-8(Z)	NPT	AD37N-8(Z)	<table border="1"> <tr><td>Port thread</td><td>⑦Part no.</td><td>D</td></tr> <tr><td>Rc</td><td>AD38-8</td><td>φ 10</td></tr> <tr><td>G</td><td>AD38N-8(Z)</td><td>φ 3/8"</td></tr> <tr><td>NPT</td><td>AD38N-8(Z)</td><td>φ 3/8"</td></tr> </table> <p>D: APPLICABLE TUBE EXTERNAL DIAMETER</p>		Port thread	⑦Part no.	D	Rc	AD38-8	φ 10	G	AD38N-8(Z)	φ 3/8"	NPT	AD38N-8(Z)	φ 3/8"	<table border="1"> <tr><td>Port thread</td><td>⑦Part no.</td></tr> <tr><td>Rc</td><td>C3LF-8J</td></tr> <tr><td>G</td><td>C3LFF-8J</td></tr> <tr><td>NPT</td><td>C3LFN-8J(Z)</td></tr> </table>		Port thread	⑦Part no.	Rc	C3LF-8J	G	C3LFF-8J	NPT	C3LFN-8J(Z)																																																																																								
Port thread	⑦Part no.																																																																																																																																					
Rc	C3LF-8																																																																																																																																					
G	C3LF-8																																																																																																																																					
NPT	C3LF-8(Z)																																																																																																																																					
Port thread	⑦Part no.																																																																																																																																					
Rc	AD37-8																																																																																																																																					
G	AD37N-8(Z)																																																																																																																																					
NPT	AD37N-8(Z)																																																																																																																																					
Port thread	⑦Part no.	D																																																																																																																																				
Rc	AD38-8	φ 10																																																																																																																																				
G	AD38N-8(Z)	φ 3/8"																																																																																																																																				
NPT	AD38N-8(Z)	φ 3/8"																																																																																																																																				
Port thread	⑦Part no.																																																																																																																																					
Rc	C3LF-8J																																																																																																																																					
G	C3LFF-8J																																																																																																																																					
NPT	C3LFN-8J(Z)																																																																																																																																					

Note 1) B in the table shows full dimensions of the product. Refer to 「11. DIMENSIONS」(P19).

Note 2) Min. operating pressure is 0.15MPa for N.C. type and 0.1MPa for N.O. type.

Note 3) The part with no. ⑦ includes ⑥ Bowl O ring. Refer to 「10. DISASSEMBLY DRAWING」(P16~P18).

Note 4) "Z" of the part with no. ⑦ is semi-standard for indicated unit of pressure and temperature, which is PSI and ° F

Note 5) The symbol for option and semi-standard are described as 「4. HOW TO ORDER」(P6).

3) Bowl assembly/Auto drain for AWD40

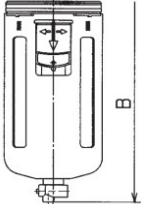
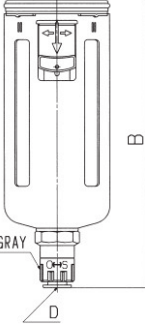
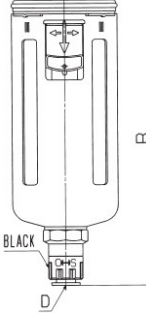
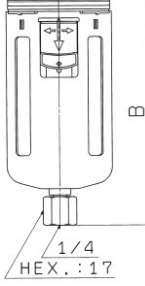
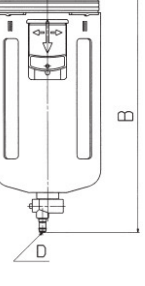
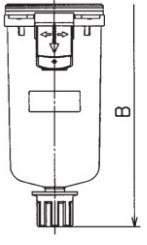
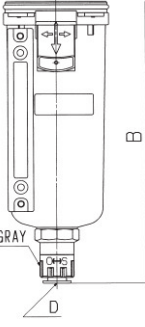
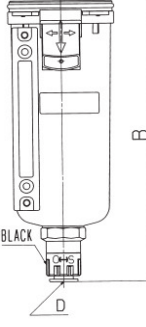
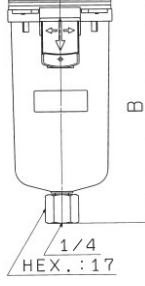
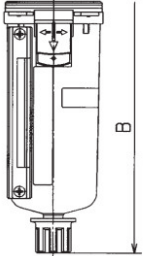
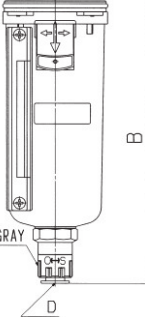
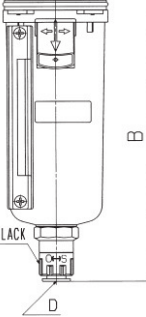
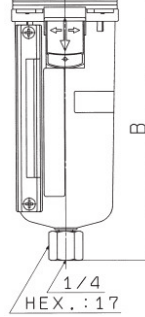
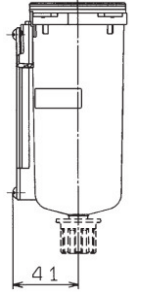
Accessory	—		Note2) C	Note2) D	—		—																																																																																																																																									
Option	—	6	—	6	—	J	6J	W	6W																																																																																																																																							
External appearance drawing																																																																																																																																																
Part no.	<table border="1"> <tr><td colspan="2">Option 「-」 (Standard)</td></tr> <tr><td>Port thread</td><td>⑦Part no.</td></tr> <tr><td>Rc</td><td rowspan="3">C4SF</td></tr> <tr><td>G</td></tr> <tr><td>NPT</td><td>C4SF(-Z)</td></tr> <tr><td colspan="2">Option 「6」</td></tr> <tr><td>Port thread</td><td>⑦Part no.</td></tr> <tr><td>Rc</td><td rowspan="3">C4SF-6</td></tr> <tr><td>G</td></tr> <tr><td>NPT</td><td>C4SF-6(Z)</td></tr> </table>		Option 「-」 (Standard)		Port thread	⑦Part no.	Rc	C4SF	G	NPT	C4SF(-Z)	Option 「6」		Port thread	⑦Part no.	Rc	C4SF-6	G	NPT	C4SF-6(Z)	<table border="1"> <tr><td colspan="3">Option 「-」</td></tr> <tr><td>Port thread</td><td>⑦Part no.</td><td>D</td></tr> <tr><td>Rc</td><td rowspan="2">AD47</td><td rowspan="2">φ 10</td></tr> <tr><td>G</td></tr> <tr><td>NPT</td><td>AD47N(-Z)</td><td>φ 3/8"</td></tr> <tr><td colspan="3">D: APPLICABLE TUBE EXTERNAL DIAMETER</td></tr> <tr><td colspan="3">Option 「6」</td></tr> <tr><td>Port thread</td><td>⑦Part no.</td><td>D</td></tr> <tr><td>Rc</td><td rowspan="2">AD47-6</td><td rowspan="2">φ 10</td></tr> <tr><td>G</td></tr> <tr><td>NPT</td><td>AD47N-6(Z)</td><td>φ 3/8"</td></tr> <tr><td colspan="3">D: APPLICABLE TUBE EXTERNAL DIAMETER</td></tr> </table>		Option 「-」			Port thread	⑦Part no.	D	Rc	AD47	φ 10	G	NPT	AD47N(-Z)	φ 3/8"	D: APPLICABLE TUBE EXTERNAL DIAMETER			Option 「6」			Port thread	⑦Part no.	D	Rc	AD47-6	φ 10	G	NPT	AD47N-6(Z)	φ 3/8"	D: APPLICABLE TUBE EXTERNAL DIAMETER			<table border="1"> <tr><td colspan="3">Option 「-」</td></tr> <tr><td>Port thread</td><td>⑦Part no.</td><td>D</td></tr> <tr><td>Rc</td><td rowspan="2">AD48</td><td rowspan="2">φ 10</td></tr> <tr><td>G</td></tr> <tr><td>NPT</td><td>AD48N(-Z)</td><td>φ 3/8"</td></tr> <tr><td colspan="3">D: APPLICABLE TUBE EXTERNAL DIAMETER</td></tr> <tr><td colspan="3">Option 「6」</td></tr> <tr><td>Port thread</td><td>⑦Part no.</td><td>D</td></tr> <tr><td>Rc</td><td rowspan="2">AD48-6</td><td rowspan="2">φ 10</td></tr> <tr><td>G</td></tr> <tr><td>NPT</td><td>AD48N-6(Z)</td><td>φ 3/8"</td></tr> <tr><td colspan="3">D: APPLICABLE TUBE EXTERNAL DIAMETER</td></tr> </table>		Option 「-」			Port thread	⑦Part no.	D	Rc	AD48	φ 10	G	NPT	AD48N(-Z)	φ 3/8"	D: APPLICABLE TUBE EXTERNAL DIAMETER			Option 「6」			Port thread	⑦Part no.	D	Rc	AD48-6	φ 10	G	NPT	AD48N-6(Z)	φ 3/8"	D: APPLICABLE TUBE EXTERNAL DIAMETER			<table border="1"> <tr><td colspan="2">Option 「J」</td></tr> <tr><td>Port thread</td><td>⑦Part no.</td></tr> <tr><td>Rc</td><td rowspan="3">C4SF-J</td></tr> <tr><td>G</td><td>C4SFF-J</td></tr> <tr><td>NPT</td><td>C4SFN-J(Z)</td></tr> <tr><td colspan="2">Option 「6J」</td></tr> <tr><td>Port thread</td><td>⑦Part no.</td></tr> <tr><td>Rc</td><td rowspan="3">C4SF-6J</td></tr> <tr><td>G</td><td>C4SFF-6J</td></tr> <tr><td>NPT</td><td>C4SFN-6J(Z)</td></tr> </table>		Option 「J」		Port thread	⑦Part no.	Rc	C4SF-J	G	C4SFF-J	NPT	C4SFN-J(Z)	Option 「6J」		Port thread	⑦Part no.	Rc	C4SF-6J	G	C4SFF-6J	NPT	C4SFN-6J(Z)	<table border="1"> <tr><td colspan="3">Option 「W」</td></tr> <tr><td>Port thread</td><td>⑦Part no.</td><td>D</td></tr> <tr><td>Rc</td><td rowspan="2">C4SF-W</td><td rowspan="2">T0604</td></tr> <tr><td>G</td></tr> <tr><td>NPT</td><td>C4SF-W(Z)</td><td></td></tr> <tr><td colspan="3">D: APPLICABLE TUBE</td></tr> <tr><td colspan="3">Option 「6W」</td></tr> <tr><td>Port thread</td><td>⑦Part no.</td><td>D</td></tr> <tr><td>Rc</td><td rowspan="2">C4SF-6W</td><td rowspan="2">T0604</td></tr> <tr><td>G</td></tr> <tr><td>NPT</td><td>C4SF-6W(Z)</td><td></td></tr> <tr><td colspan="3">D: APPLICABLE TUBE</td></tr> </table>		Option 「W」			Port thread	⑦Part no.	D	Rc	C4SF-W	T0604	G	NPT	C4SF-W(Z)		D: APPLICABLE TUBE			Option 「6W」			Port thread	⑦Part no.	D	Rc	C4SF-6W	T0604	G	NPT	C4SF-6W(Z)		D: APPLICABLE TUBE		
Option 「-」 (Standard)																																																																																																																																																
Port thread	⑦Part no.																																																																																																																																															
Rc	C4SF																																																																																																																																															
G																																																																																																																																																
NPT		C4SF(-Z)																																																																																																																																														
Option 「6」																																																																																																																																																
Port thread	⑦Part no.																																																																																																																																															
Rc	C4SF-6																																																																																																																																															
G																																																																																																																																																
NPT		C4SF-6(Z)																																																																																																																																														
Option 「-」																																																																																																																																																
Port thread	⑦Part no.	D																																																																																																																																														
Rc	AD47	φ 10																																																																																																																																														
G																																																																																																																																																
NPT	AD47N(-Z)	φ 3/8"																																																																																																																																														
D: APPLICABLE TUBE EXTERNAL DIAMETER																																																																																																																																																
Option 「6」																																																																																																																																																
Port thread	⑦Part no.	D																																																																																																																																														
Rc	AD47-6	φ 10																																																																																																																																														
G																																																																																																																																																
NPT	AD47N-6(Z)	φ 3/8"																																																																																																																																														
D: APPLICABLE TUBE EXTERNAL DIAMETER																																																																																																																																																
Option 「-」																																																																																																																																																
Port thread	⑦Part no.	D																																																																																																																																														
Rc	AD48	φ 10																																																																																																																																														
G																																																																																																																																																
NPT	AD48N(-Z)	φ 3/8"																																																																																																																																														
D: APPLICABLE TUBE EXTERNAL DIAMETER																																																																																																																																																
Option 「6」																																																																																																																																																
Port thread	⑦Part no.	D																																																																																																																																														
Rc	AD48-6	φ 10																																																																																																																																														
G																																																																																																																																																
NPT	AD48N-6(Z)	φ 3/8"																																																																																																																																														
D: APPLICABLE TUBE EXTERNAL DIAMETER																																																																																																																																																
Option 「J」																																																																																																																																																
Port thread	⑦Part no.																																																																																																																																															
Rc	C4SF-J																																																																																																																																															
G		C4SFF-J																																																																																																																																														
NPT		C4SFN-J(Z)																																																																																																																																														
Option 「6J」																																																																																																																																																
Port thread	⑦Part no.																																																																																																																																															
Rc	C4SF-6J																																																																																																																																															
G		C4SFF-6J																																																																																																																																														
NPT		C4SFN-6J(Z)																																																																																																																																														
Option 「W」																																																																																																																																																
Port thread	⑦Part no.	D																																																																																																																																														
Rc	C4SF-W	T0604																																																																																																																																														
G																																																																																																																																																
NPT	C4SF-W(Z)																																																																																																																																															
D: APPLICABLE TUBE																																																																																																																																																
Option 「6W」																																																																																																																																																
Port thread	⑦Part no.	D																																																																																																																																														
Rc	C4SF-6W	T0604																																																																																																																																														
G																																																																																																																																																
NPT	C4SF-6W(Z)																																																																																																																																															
D: APPLICABLE TUBE																																																																																																																																																
Accessory	—		Note2) C	Note2) D	—																																																																																																																																											
Option	2		2	2	2J																																																																																																																																											
External appearance drawing																																																																																																																																																
Part no.	<table border="1"> <tr><td>Port thread</td><td>⑦Part no.</td></tr> <tr><td>Rc</td><td rowspan="3">C4SF-2</td></tr> <tr><td>G</td></tr> <tr><td>NPT</td><td>C4SF-2(Z)</td></tr> </table>		Port thread	⑦Part no.	Rc	C4SF-2	G	NPT	C4SF-2(Z)	<table border="1"> <tr><td>Port thread</td><td>⑦Part no.</td><td>D</td></tr> <tr><td>Rc</td><td rowspan="2">AD47-2</td><td rowspan="2">φ 10</td></tr> <tr><td>G</td></tr> <tr><td>NPT</td><td>AD47N-2(Z)</td><td>φ 3/8"</td></tr> <tr><td colspan="3">D: APPLICABLE TUBE EXTERNAL DIAMETER</td></tr> </table>		Port thread	⑦Part no.	D	Rc	AD47-2	φ 10	G	NPT	AD47N-2(Z)	φ 3/8"	D: APPLICABLE TUBE EXTERNAL DIAMETER			<table border="1"> <tr><td>Port thread</td><td>⑦Part no.</td><td>D</td></tr> <tr><td>Rc</td><td rowspan="2">AD48-2</td><td rowspan="2">φ 10</td></tr> <tr><td>G</td></tr> <tr><td>NPT</td><td>AD48N-2(Z)</td><td>φ 3/8"</td></tr> <tr><td colspan="3">D: APPLICABLE TUBE EXTERNAL DIAMETER</td></tr> </table>		Port thread	⑦Part no.	D	Rc	AD48-2	φ 10	G	NPT	AD48N-2(Z)	φ 3/8"	D: APPLICABLE TUBE EXTERNAL DIAMETER			<table border="1"> <tr><td>Port thread</td><td>⑦Part no.</td></tr> <tr><td>Rc</td><td rowspan="3">C4SF-2J</td></tr> <tr><td>G</td><td>C4SFF-2J</td></tr> <tr><td>NPT</td><td>C4SFN-2J(Z)</td></tr> </table>		Port thread	⑦Part no.	Rc	C4SF-2J	G	C4SFF-2J	NPT	C4SFN-2J(Z)																																																																																															
Port thread	⑦Part no.																																																																																																																																															
Rc	C4SF-2																																																																																																																																															
G																																																																																																																																																
NPT		C4SF-2(Z)																																																																																																																																														
Port thread	⑦Part no.	D																																																																																																																																														
Rc	AD47-2	φ 10																																																																																																																																														
G																																																																																																																																																
NPT	AD47N-2(Z)	φ 3/8"																																																																																																																																														
D: APPLICABLE TUBE EXTERNAL DIAMETER																																																																																																																																																
Port thread	⑦Part no.	D																																																																																																																																														
Rc	AD48-2	φ 10																																																																																																																																														
G																																																																																																																																																
NPT	AD48N-2(Z)	φ 3/8"																																																																																																																																														
D: APPLICABLE TUBE EXTERNAL DIAMETER																																																																																																																																																
Port thread	⑦Part no.																																																																																																																																															
Rc	C4SF-2J																																																																																																																																															
G		C4SFF-2J																																																																																																																																														
NPT		C4SFN-2J(Z)																																																																																																																																														
Accessory	—		Note2) C	Note2) D	—																																																																																																																																											
Option	8		8	8	8J																																																																																																																																											
External appearance drawing																																																																																																																																																
Part no.	<table border="1"> <tr><td>Port thread</td><td>⑦Part no.</td></tr> <tr><td>Rc</td><td rowspan="3">C4LF-8</td></tr> <tr><td>G</td></tr> <tr><td>NPT</td><td>C4LF-8(Z)</td></tr> </table>		Port thread	⑦Part no.	Rc	C4LF-8	G	NPT	C4LF-8(Z)	<table border="1"> <tr><td>Port thread</td><td>⑦Part no.</td><td>D</td></tr> <tr><td>Rc</td><td rowspan="2">AD47-8</td><td rowspan="2">φ 10</td></tr> <tr><td>G</td></tr> <tr><td>NPT</td><td>AD47N-8(Z)</td><td>φ 3/8"</td></tr> <tr><td colspan="3">D: APPLICABLE TUBE EXTERNAL DIAMETER</td></tr> </table>		Port thread	⑦Part no.	D	Rc	AD47-8	φ 10	G	NPT	AD47N-8(Z)	φ 3/8"	D: APPLICABLE TUBE EXTERNAL DIAMETER			<table border="1"> <tr><td>Port thread</td><td>⑦Part no.</td><td>D</td></tr> <tr><td>Rc</td><td rowspan="2">AD48-8</td><td rowspan="2">φ 10</td></tr> <tr><td>G</td></tr> <tr><td>NPT</td><td>AD48N-8(Z)</td><td>φ 3/8"</td></tr> <tr><td colspan="3">D: APPLICABLE TUBE EXTERNAL DIAMETER</td></tr> </table>		Port thread	⑦Part no.	D	Rc	AD48-8	φ 10	G	NPT	AD48N-8(Z)	φ 3/8"	D: APPLICABLE TUBE EXTERNAL DIAMETER			<table border="1"> <tr><td>Port thread</td><td>⑦Part no.</td></tr> <tr><td>Rc</td><td rowspan="3">C4LF-8J</td></tr> <tr><td>G</td><td>C4LFF-8J</td></tr> <tr><td>NPT</td><td>C4LFN-8J(Z)</td></tr> </table>		Port thread	⑦Part no.	Rc	C4LF-8J	G	C4LFF-8J	NPT	C4LFN-8J(Z)																																																																																															
Port thread	⑦Part no.																																																																																																																																															
Rc	C4LF-8																																																																																																																																															
G																																																																																																																																																
NPT		C4LF-8(Z)																																																																																																																																														
Port thread	⑦Part no.	D																																																																																																																																														
Rc	AD47-8	φ 10																																																																																																																																														
G																																																																																																																																																
NPT	AD47N-8(Z)	φ 3/8"																																																																																																																																														
D: APPLICABLE TUBE EXTERNAL DIAMETER																																																																																																																																																
Port thread	⑦Part no.	D																																																																																																																																														
Rc	AD48-8	φ 10																																																																																																																																														
G																																																																																																																																																
NPT	AD48N-8(Z)	φ 3/8"																																																																																																																																														
D: APPLICABLE TUBE EXTERNAL DIAMETER																																																																																																																																																
Port thread	⑦Part no.																																																																																																																																															
Rc	C4LF-8J																																																																																																																																															
G		C4LFF-8J																																																																																																																																														
NPT		C4LFN-8J(Z)																																																																																																																																														

Note 1) B in the table shows full dimensions of the product. Refer to 「11. DIMENSIONS」 (P19).

Note 2) Min. operating pressure is 0.15MPa for N.C. type and 0.1MPa for N.O. type.

Note 3) The part with no. ⑦ includes ⑥ Bowl O ring. Refer to 「10. DISASSEMBLY DRAWING」 (P16~P18).

Note 4) "Z" of the part with no. ⑦ is semi-standard for indicated unit of pressure and temperature, which is PSI and ° F

Note 5) The symbol for option and semi-standard are described as 「4. HOW TO ORDER」(P6).

9. HOW TO REPLACE

Warning

Before replacement, ensure that the regulator is not pressurized.

Rotate the pressure adjusting handle to zero.

Replace referring to "10. DISASSEMBLY DRAWING" (P16~P18).

After replacement, ensure that specified function is satisfied and external leakage is not found before starting operation.

1) Bowl assembly/Element

Applicable model	Process	Procedure	Tools	Check item				
AWD20	Disassembly	1) Remove the bowl assembly Hold the bowl assembly by hand and rotate counterclockwise to remove the bowl assembly. If the bowl assembly is tightened too much to be removed, use hook spanner until it can be loosened by hand.	Hook spanner Nominal: 34/38	—				
		2) Remove the element Hold the element with a spanner to rotate it counterclockwise and remove the element.	Spanner Nominal: 7	—				
	Assembly	3) Mount the element. Hold the element with a spanner to rotate it counterclockwise and remove the element. See check item for referential tightening torque.	Spanner Nominal: 7	Tightening torque: $0.49 \pm 0.05 \text{ N}\cdot\text{m}$				
		4) Mount the bowl assembly. Hold the bowl assembly by hand and rotate clockwise. Do not use tool for mounting because the bowl may be damaged. See check item for referential tightening torque.	—	Referential tightening torque: $2.2 \text{ N}\cdot\text{m}$				
AWD30 AWD40	Disassembly	1) Remove the bowl assembly Push the bowl assembly lock button. Lifting the bowl assembly, rotate the assembly 45 degree(right or left) to pull out the assembly.	—	—				
		2) Remove the element Hold the element with a round pliers to rotate it counterclockwise and remove the element.	Round pliers	—				
	Assembly	3) Mount the element. Hold the element with a round pliers to rotate it counterclockwise and remove the element. See check item for referential tightening torque.	Round pliers	Tightening torque: <table border="1"> <tr> <td>AWD30</td> <td>$1.47 \pm 0.2 \text{ N}\cdot\text{m}$</td> </tr> <tr> <td>AWD40</td> <td>$1.96 \pm 0.2 \text{ N}\cdot\text{m}$</td> </tr> </table>	AWD30	$1.47 \pm 0.2 \text{ N}\cdot\text{m}$	AWD40	$1.96 \pm 0.2 \text{ N}\cdot\text{m}$
		AWD30	$1.47 \pm 0.2 \text{ N}\cdot\text{m}$					
AWD40	$1.96 \pm 0.2 \text{ N}\cdot\text{m}$							
4) Mount the bowl assembly. Match the mating mark of the body and the bowl assembly to insert the assembly to the body. Rotate the assembly 45 degree(right or left) until the lock button is tossed up to mount the bowl assembly. Ensure the lock button is up.	—	Lock button is up.						

2) Diaphragm assembly

Applicable model	Process	Procedure	Tools	Check item				
AWD20 AWD30 AWD40	Disassembly	1) Remove the bonnet Rotate the set screw counterclockwise with cross pointed driver to remove the bonnet from the body.	Cross pointed driver	—				
		2) Remove parts in order of the pressure adjusting screw assembly, pressure adjusting spring, and the diaphragm assembly. Please be noted that the diaphragm assembly adheres to the bonnet if disassemble parts with the handle facing downwards	—	—				
	Assembly	3) Mount parts to the body in order of the diaphragm assembly, pressure adjusting spring, and pressure adjusting screw. Mind the direction of the diaphragm assembly and pressure adjusting screw assembly. See attached disassembly drawing.	—	Direction of pressure adjusting screw assembly and diaphragm assembly				
		4) Mount the bonnet to the body Mount the convex of the bonnet comes INside to the body, and settle it roughly with four(4) set screws with a cross pointed driver. Then, Tighten screws diagonally with the tightening torque in the check item to settle.	Cross pointed driver	Tightening torque <table border="1"> <tr> <td>AWD20</td> <td>$2.15 \pm 0.3 \text{ N}\cdot\text{m}$</td> </tr> <tr> <td>AWD30</td> <td>$2.35 \pm 0.3 \text{ N}\cdot\text{m}$</td> </tr> <tr> <td>AWD40</td> <td>$3.5 \pm 0.3 \text{ N}\cdot\text{m}$</td> </tr> </table>	AWD20	$2.15 \pm 0.3 \text{ N}\cdot\text{m}$	AWD30	$2.35 \pm 0.3 \text{ N}\cdot\text{m}$
AWD20	$2.15 \pm 0.3 \text{ N}\cdot\text{m}$							
AWD30	$2.35 \pm 0.3 \text{ N}\cdot\text{m}$							
AWD40	$3.5 \pm 0.3 \text{ N}\cdot\text{m}$							

3) Valve assembly

Applicable model	Process	Procedure	Tools	Check item
AWD20	Disassembly	1) Remove element after removing bowl assembly. Hold the element with a spanner to rotate it counterclockwise and remove the element.	Spanner Nominal: 7	—
		2) Hold the valve guide with a socket wrench to rotate it counterclockwise and remove the valve guide.	Socket wrench Nominal: 18	—
		3) Remove the valve spring.	—	—
		4) Remove the valve.	—	—
	Assembly	5) Mount the valve . Mate the stem convex and the valve assembly center hole.	—	Positioning the stem and the valve(centering)
		6) Mount the valve spring. Insert the valve spring to the valve hole.	—	—
		7) Mount the valve guide. Hold the valve guide with a socket wrench to rotate it clockwise and mount the valve guide. See check item for the tightening torque.	Socket wrench Nominal: 18	Tightening torque: 40±3.5N·m
		8) Mount the element. Hold the element with a spanner to rotate it clockwise and remove the element. See check item for the tightening torque.	Spanner Nominal: 7	Tightening torque: 0.35±0.05N·m
		9) Mount the bowl assembly. Hold the bowl assembly by hand and rotate clockwise. Do not use tool for mounting because the bowl may be damaged. See check item for referential tightening torque.	—	Referential tightening torque: 2.2N·m
AWD30 AWD40	Disassembly	1) Remove element after removing bowl assembly. Hold the element with a round pliers to rotate it counterclockwise and remove the element.	Round pliers	—
		2) Hold the valve guide with a spanner to rotate it counterclockwise and remove the valve guide.	<u>Spanner nominal</u> AWD30 8 AWD40 12	—
		3) Remove the valve spring.	—	—
		4) Remove the valve.	—	—
	Assembly	5) Mount the valve . Mate the stem convex and the valve assembly center hole.	—	Positioning the stem and the valve(centering)
		6) Mount the valve spring. Insert the valve spring to the valve hole.	—	—
		7) Mount the valve guide. Hold the valve guide with a spanner to rotate it clockwise and mount the valve guide. See check item for the tightening torque.	<u>Spanner nominal</u> AWD30 8 AWD40 12	<u>Tightening torque</u> AWD30 25±2.5N·m AWD40 55± 5N·m
		8) Mount the element. Hold the element with a round pliers to rotate it clockwise and mount the element. See check item for the tightening torque.	Round pliers	Tightening torque: 0.35±0.05N·m
		9) Mount the bowl assembly. Match the mating mark of the body and the bowl assembly to insert the assembly to the body. Rotate the assembly 45 degree(right or left) until the lock button is tossed up to mount the bowl assembly. Ensure the lock button is up.	—	Lock button is up.

4) Bracket assembly/panel mount

Applicable model	Process	Procedure	Tools	Check item
AWD20 AWD30 AWD40	Assembly	1) Mount the parts to the bracket(panel) Mate the bracket(panel) concave and the bonnet convex to mount the bracket.	—	—
		2) Settle the bracket(panel) with set nut. Rotate the set nut clockwise with a hook spanner to settle the parts to the bracket(panel). See check item for tightening torque. Set nut roulette faces shall face the bracket. When mounting with bracket, set nut tightened manually is adequate fir general used.	AWM20/30/40 Hook spanner Nominal AWD20 34/38 AWD30 52/55 AWD40 52/55	<u>Tightening torque</u> AWD20 2.0±0.2N·m AWD30 3.5±0.3N·m AWD40 4.0±0.4N·m

5) Square embedded pressure gauge

Applicable model	Process	Procedure	Tools	Check item
AWD20 AWD30 AWD40	Disassembly	1) Remove the pressure gauge cover Rotate the pressure gauge cover 15 degree counterclockwise to pull out the pressure gauge cover.	—	—
		2) Remove the pressure gauge Rotate two set screws counterclockwise with cross pointed driver to remove the pressure gauge and two set screws.	Cross pointed driver	—
	Assembly	3) Ensure "O" ring is mounted to the pressure gauge Mount "O" ring to the pressure gauge if the ring fall off.	—	Presence of "O" ring
		4) Mount the pressure gauge Rotate two set screws clockwise with cross pointed driver to set screws temporary. Then settle them with tightening torque in check item.	Cross pointed driver	Tightening torque : 0.3±0.05N·m
		5) Mount the pressure gauge cover Insert the pressure gauge mating two detent of the pressure gauge and holes for them so that the arrow of the pressure gauge cover comes upper right. Rotate the pressure gauge cover 15 degree opposite to the arrow to mount the pressure gauge.	—	—

6) Circular pressure gauge

Applicable model	Process	Procedure	Tools	Check item
AWD20 AWD30 AWD40	Disassembly	1) Remove the pressure gauge Hold the pressure gauge with a spanner on the spanner flat. Then, rotate the gauge counterclockwise to remove the gauge.	Spanner Nominal: <u>AWD20</u> 12 <u>AWD30</u> <u>AWD40</u> 14	—
		2) Rap the pressure gauge thread with the seal tape leaving 1.5 to 2 threads from the end.	—	Wrap seal tape leaving 1.5 to 2 threads
	Assembly	3) Mount the pressure gauge Hold the pressure gauge on the spanner flat with a spanner, and rotate it clockwise to mount the circular pressure gauge. See Check item for tightening torque of pressure gauge.	Spanner Nominal: <u>AWD20</u> 12 <u>AWD30</u> <u>AWD40</u> 14	Tightening torque : <u>AWD20</u> 7~9 N·m <u>AWD30</u> <u>AWD40</u> 12~14 N·m

7) Pressure gauge adapter, Plug assembly

Applicable model	Process	Procedure	Tools	Check item
AWD20 AWD30 AWD40	Disassembly	1) Remove the plug Insert the hexagon spanner to hexagon hole of hexagon plug. Rotate the plug counterclockwise to remove the plug.	Spanner Nominal: <u>AWD20</u> 4 <u>AWD30</u> <u>AWD40</u> 6	—
		2) Remove the pressure gauge adapter Rotate two set screws counterclockwise with cross pointed driver to remove the pressure gauge and two set screws.	Cross pointed driver	—
	Assembly	3) Confirm pressure gauge adapter has "O" ring. If not, mount "O" ring.	—	—
		4) Mount pressure gauge adapter. Rotate two screws clockwise by Phillips driver to fix pressure gauge adapter. See Check item for tightening torque of two screws.	Cross pointed driver (Torque driver)	Tightening torque : 0.3±0.05N·m
		5) Mount plug assembly. Insert hexagon spanner into hexagon hole on the plug and rotate clockwise to fix the plug. See Check item for tightening torque of two screws.	Spanner Nominal: <u>AWD20</u> 4 <u>AWD30</u> <u>AWD40</u> 6	Tightening torque : <u>AWD20</u> 0.6±0.05 N·m <u>AWD30</u> <u>AWD40</u> 1.0±0.1 N·m

8) Blanking plate

Applicable model	Process	Procedure	Tools	Check item
AWD20 AWD30 AWD40	Disassembly	1) Rotate two set screws counterclockwise with cross pointed driver to remove the blanking plate and two set screws.	Cross pointed driver	—
		2) Remove the pressure gauge adapter Confirm blanking plate has "O" ring. If not, mount "O" ring.	—	—
	Assembly	3) Mount the blanking plate. Rotate two screws clockwise by Phillips driver to fix blanking plate. See Check item for tightening torque of two screws.	Cross pointed driver (Torque driver)	Tightening torque : 0.3±0.05N·m

10. DISASSEMBLY DRAWING

1) AWD20 Disassembly drawing.

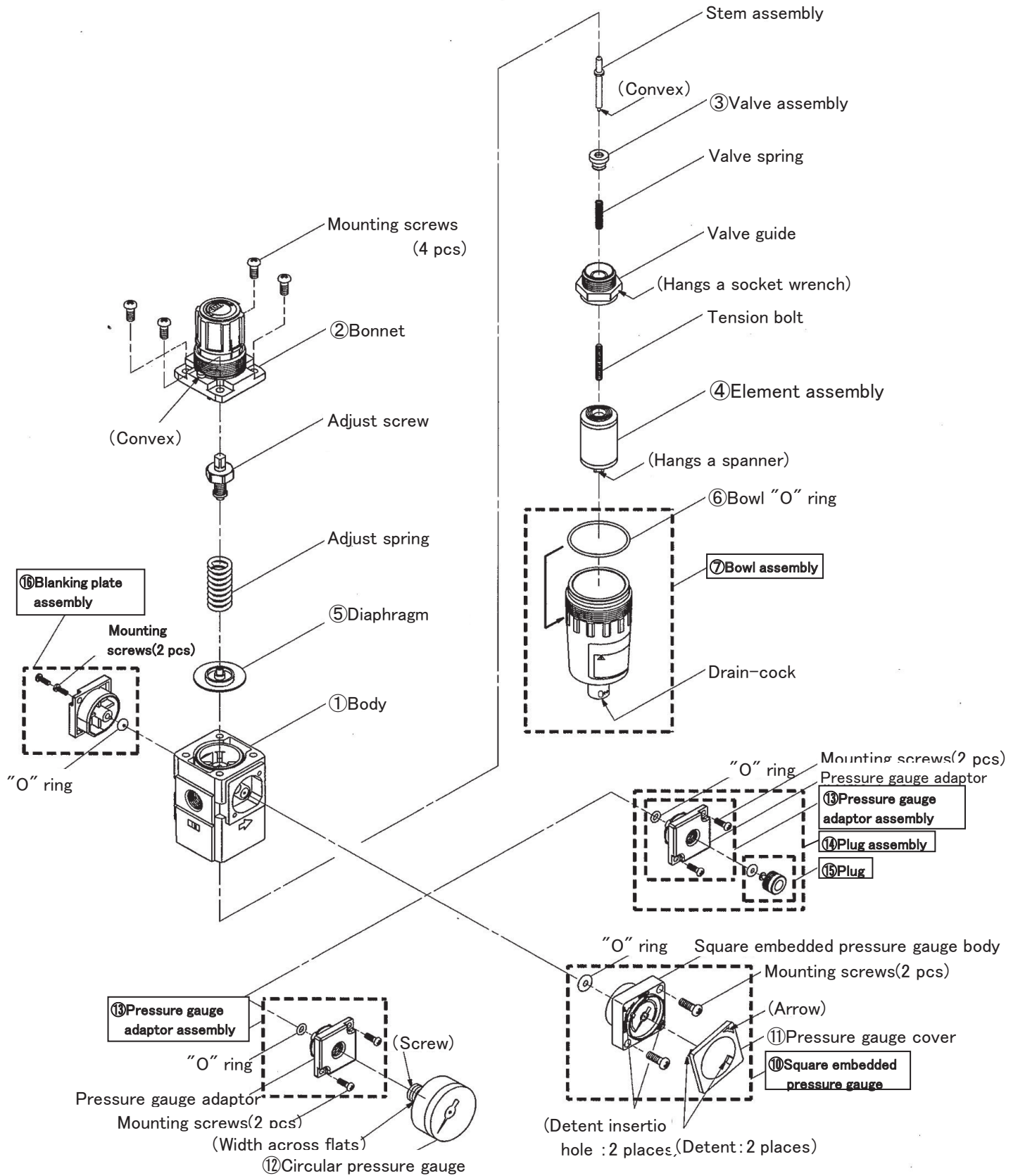

Note.) It is possible to mount ⑩ Square embedded pressure gauge or ⑬ Pressure gauge adaptor assembly or ⑭ Plug assembly instead of ①⑥ Blanking plate assembly.

2) AWD30/40 Disassembly drawing.

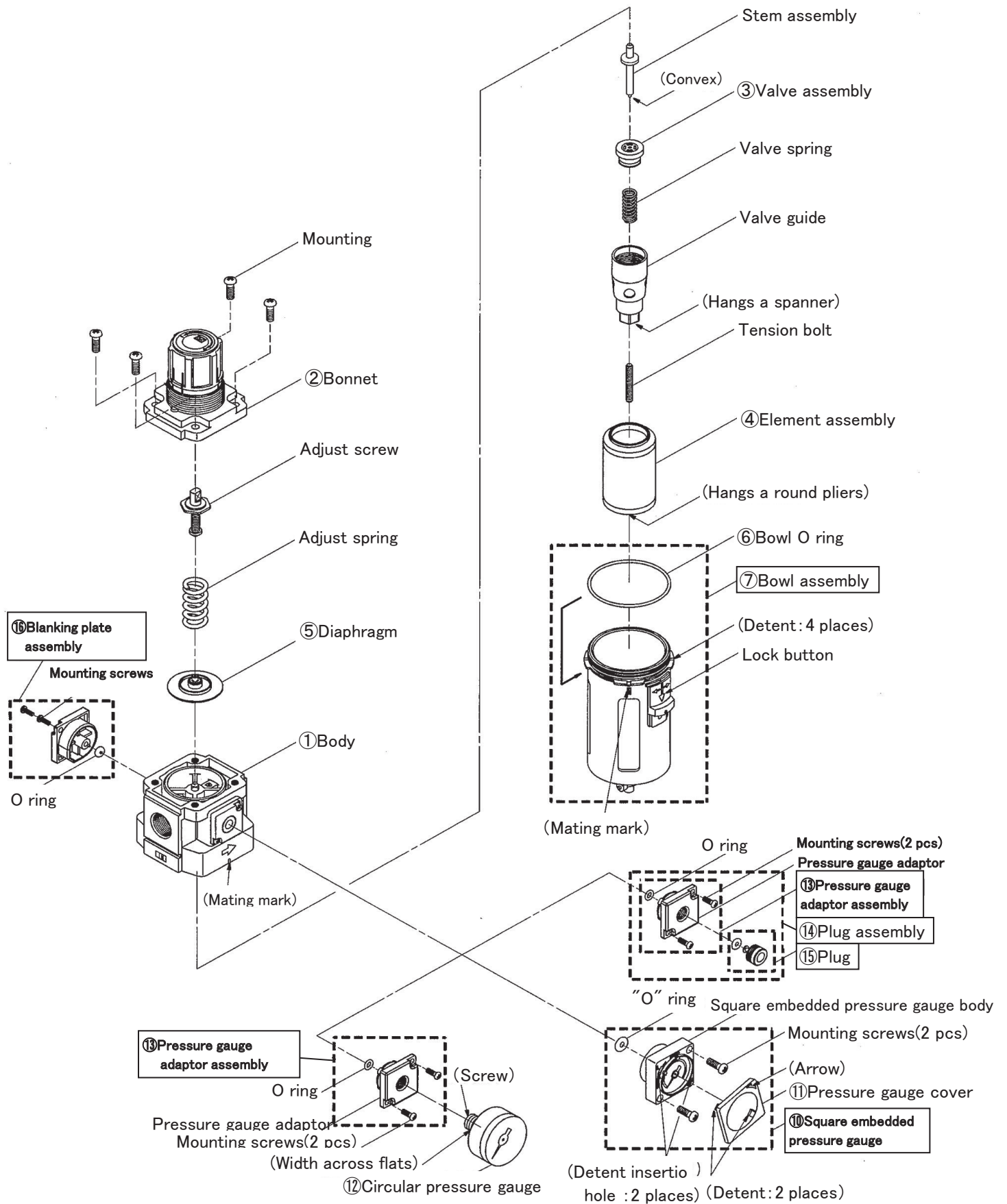

Note.) It is possible to mount ⑩ Square embedded pressure gauge or ⑬ Pressure gauge adaptor assembly or ⑭ Plug assembly instead of ⑮ Blanking plate assembly.

3)AWD20/30/40 Bracket assembly•Panel mounting Disassembly drawing.

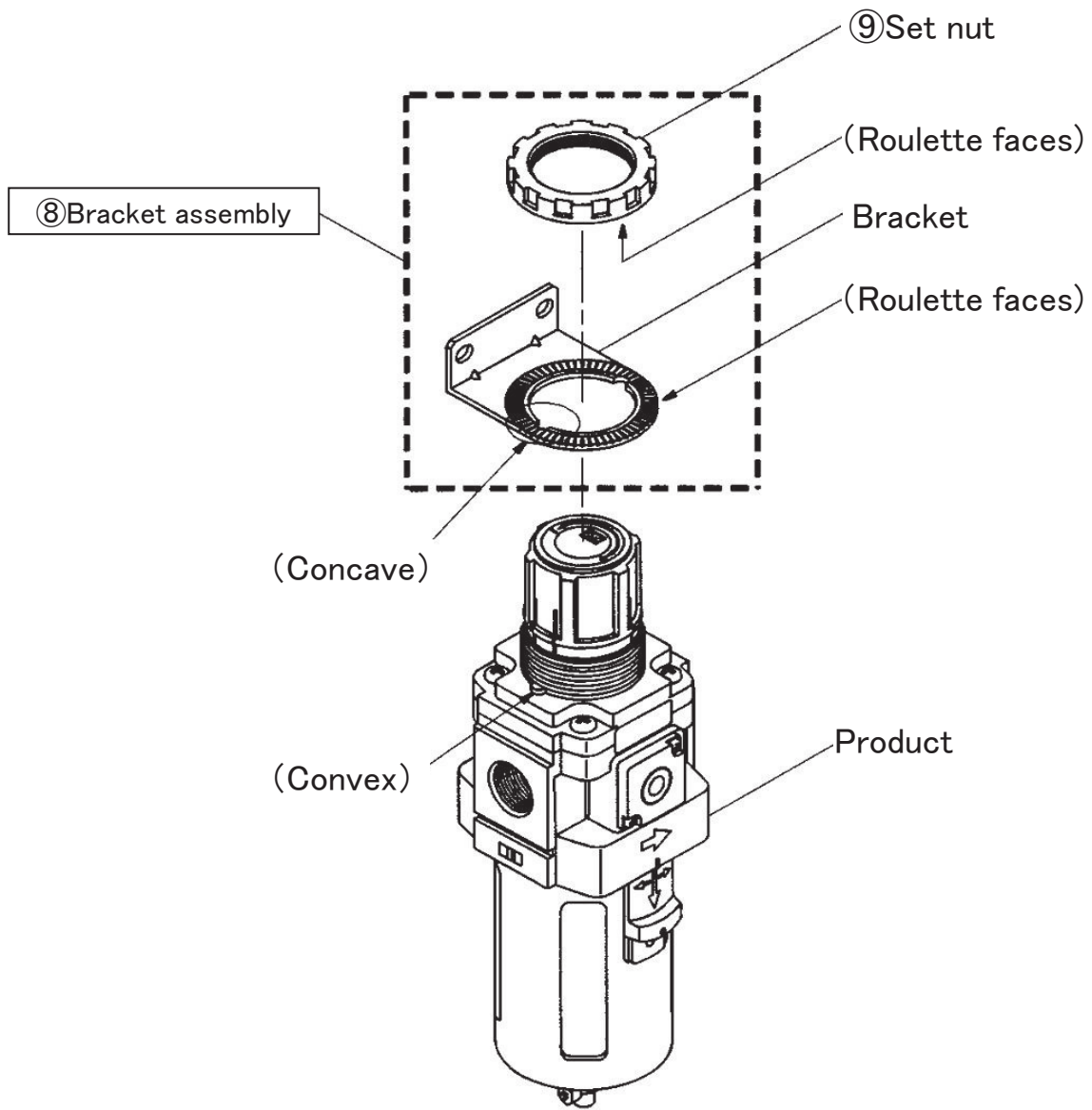

11. DIMENSIONS

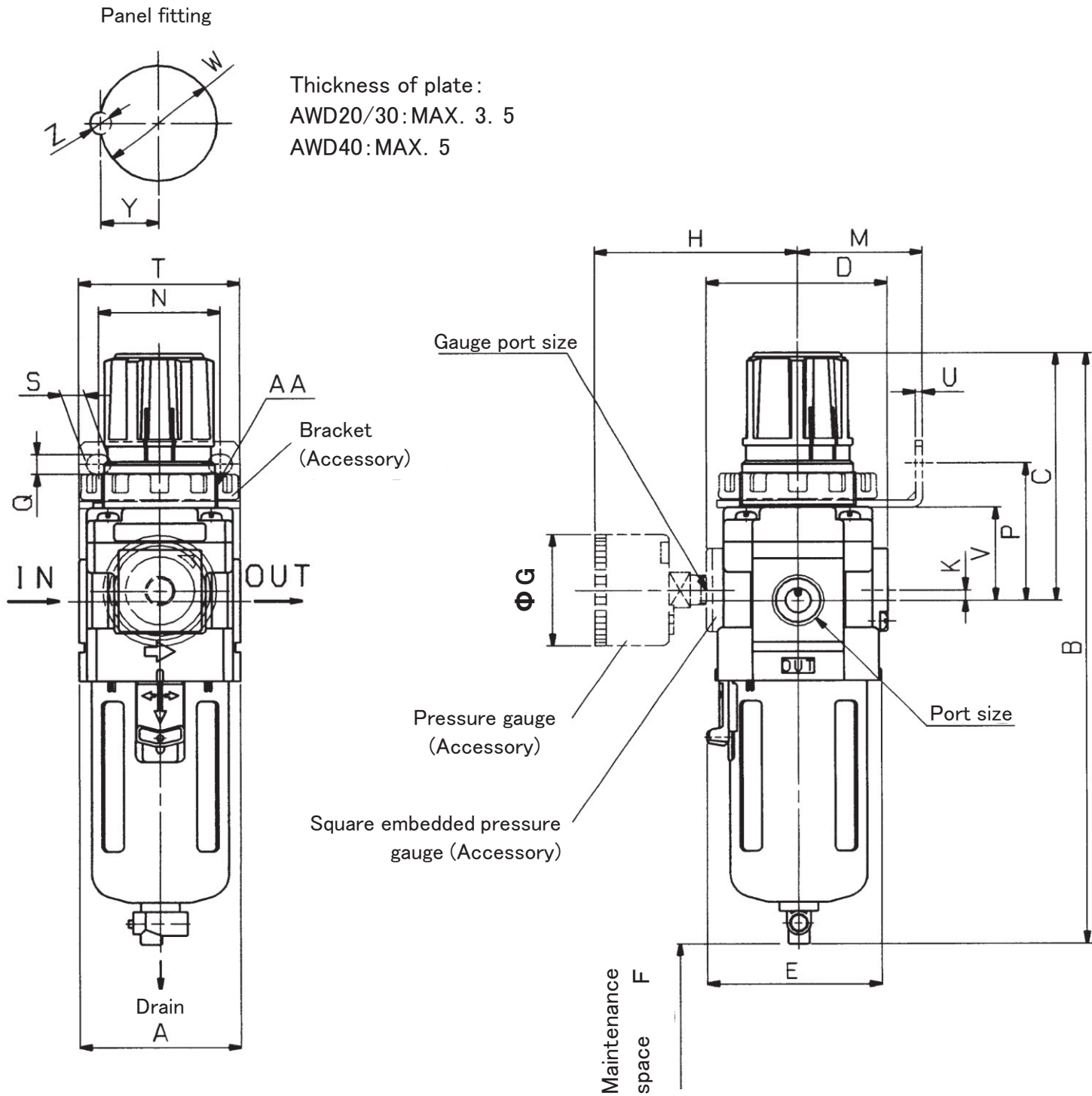

Dimensions

Model	Port size	Gauge port size	Standard							Accessory								
			A		C	D	E	F	Pressure gauge			Bracket mounting dimensions						
			A	B ^(Note1)					G	H	K	M	N	P	Q	S	T	U
AWD20	1/8·1/4	1/8	40	173	73	52	—	45	37.5	63	5	30	34	44	5.4	15.4	55	2.3
AWD30	1/4·3/8	1/8	53	201	86	59	57	50	37.5	66	3.5	41	40	46	6.5	8	53	2.3
AWD40	1/4·3/8·1/2	1/4	70	239	92	75	73	70	42.5	76	1.5	50	54	54	8.5	10.5	70	2.3

Model	Accessory				
	Panel mounting				
	V	W	Y	Z	AA
AWD20	30	28.5	14	6	M28×1
AWD30	31	38.5	19	7	M38×1.5
AWD40	35.5	42.5	21	7	M42×1.5

B for Auto-drain/Optional bowl assembly

Model	Accessory													Option									
	2	6	8	C	6C	J	2J	6J	8J	CJ	6CJ	W	6W	—	2	6	8	C	6C	—	2	6	8
AWD20	173	173	—	173	173	177	180	177	—	177	177	—	—	190	190	190	—	190	190	—	—	—	—
AWD30	214	201	234	—	—	208	208	208	228	—	—	209	209	242	242	242	242	—	—	242	242	242	242
AWD40	251	239	272	—	—	246	246	246	266	—	—	247	247	278	280	278	280	—	—	278	280	278	280

Note 1) The specifications of auto-drain and optional bowl assembly are described in 「8. SPECIFICATIONS OF BOWL ASSEMBLY」 (P10~P12).

Revision history

A	The tightening torque value of the element assy is changed.	2017.7
---	---	--------

SMC Corporation

4-14-1, Sotokanda, Chiyoda-ku, Tokyo 101-0021 JAPAN

Tel: + 81 3 5207 8249 Fax: +81 3 5298 5362

URL <http://www.smcworld.com>

Note: Specifications are subject to change without prior notice and any obligation on the part of the manufacturer.
© 2008 SMC Corporation All Rights Reserved

